

15th German LS-DYNA Forum

Modeling bolts in LS-DYNA[®] using explicit and implicit time integration

Nils Karajan, Alexander Gromer (DYNAmore Corp.),
Maik Schenke (DYNAmore GmbH);
Thomas Borrvall (DYNAmore Nordic);
Kishore Pydimarry (Honda R&D Americas, Inc.)

17 October 2018, Bamberg, Germany

“Phenomena” encountered in implicit simulations

- Sure enough, other problems may arise
 - Full car model for explicit crash analysis was converted to implicit
 - Bolts caused one of the problems encountered
 - Residual forces during pre-tensioning are not converging

Time = 0.0016001

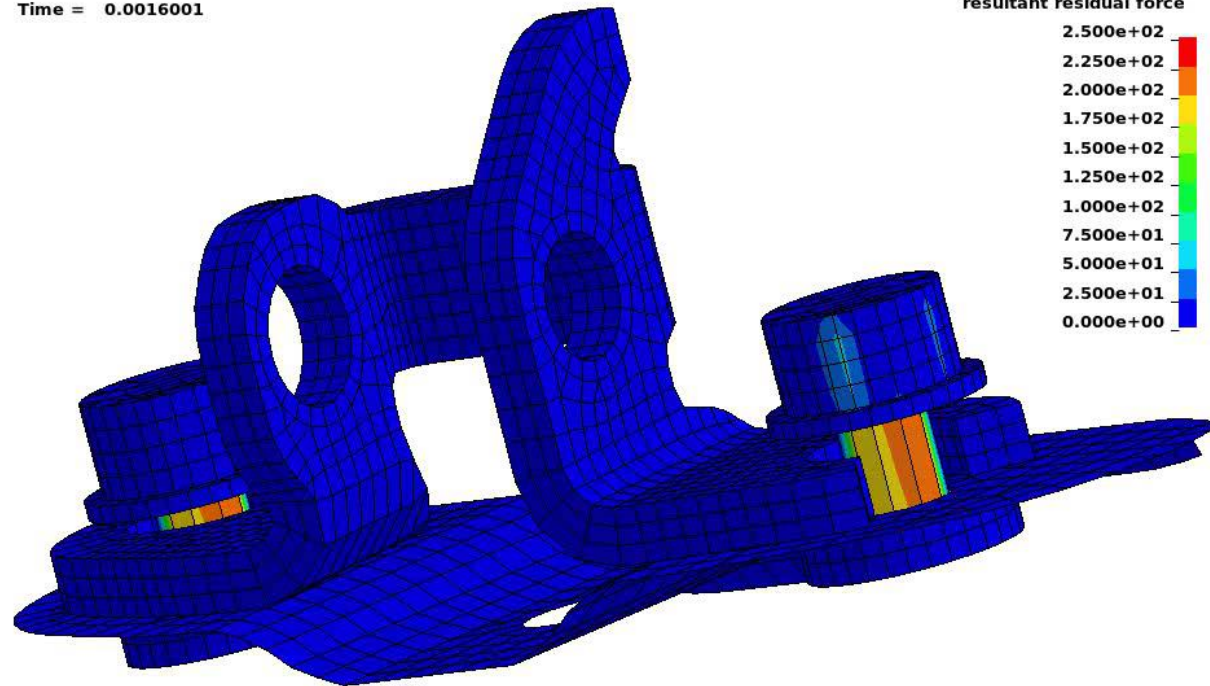

Let's do a paper
on bolt modeling
to investigate this further
and to share findings!

Friction Grip Bolts

Definitions and load bearing mechanism

■ What is a bolted friction grip connection

- Fastener is a bolt with a head, a threaded shank and a nut to apply tension
- Washers may be included to distribute tensioning loads more evenly
- Joins two or more sheets or blocks of material
- Load carrying mechanism
 - Bolt pre-tensioning (clamping) allows to build up friction forces
 - Service loads are only carried by friction forces between plates
 - Above service loads, slipping occurs until hole bearing forces take over

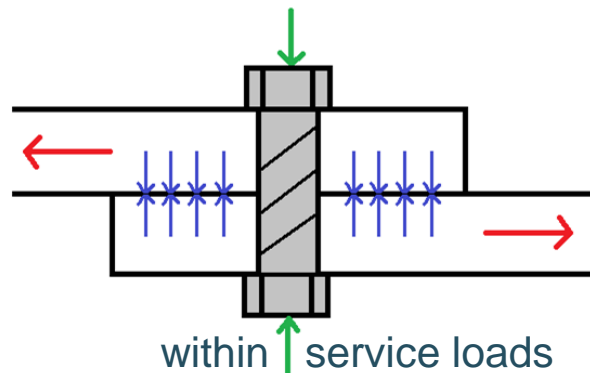
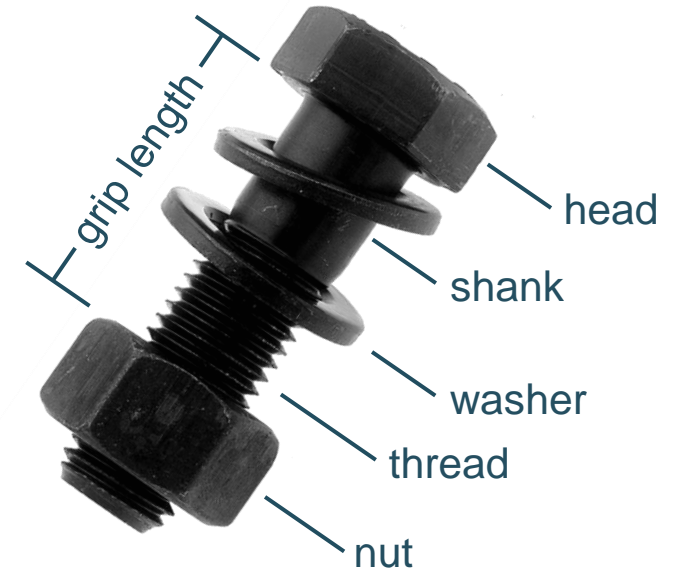

transition during
crash load cases

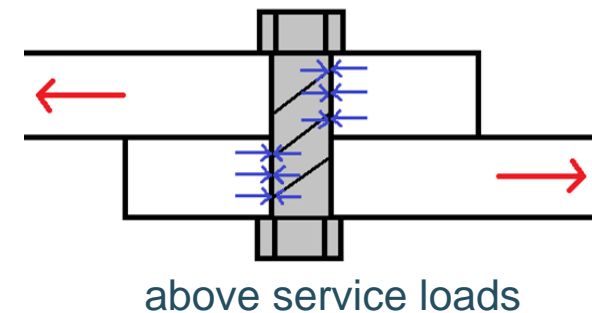

[images: www.wikipedia.com]

■ In-plane failure modes

- Above service loads the law of static friction is violated
- Slipping motion between plates with dynamic friction resisting the motion
- Hole bearing forces take over after bolt-to-plate contact is established
- Failure will occur in the weakest part of the bolt or the plate

■ Bolt fails in shear

■ Plate fails in shear

■ Plate tears out

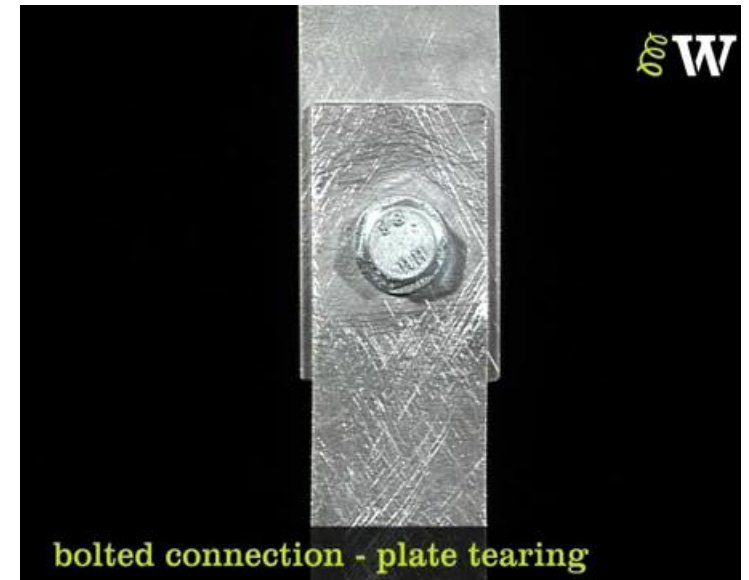
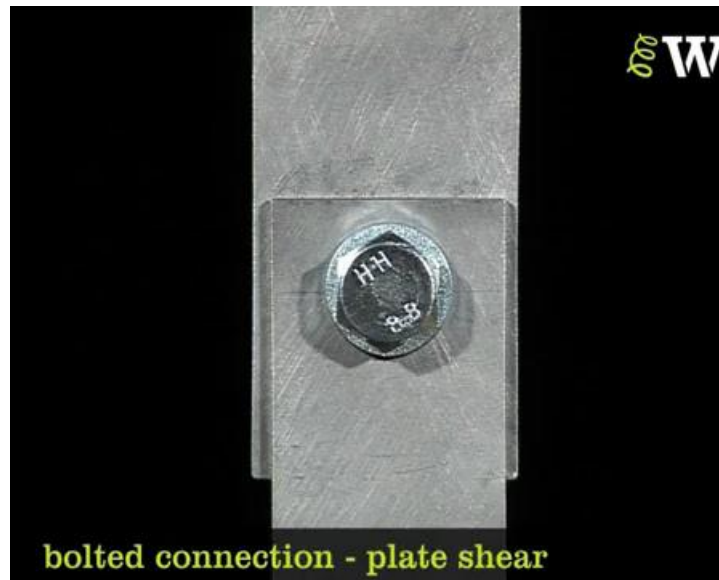
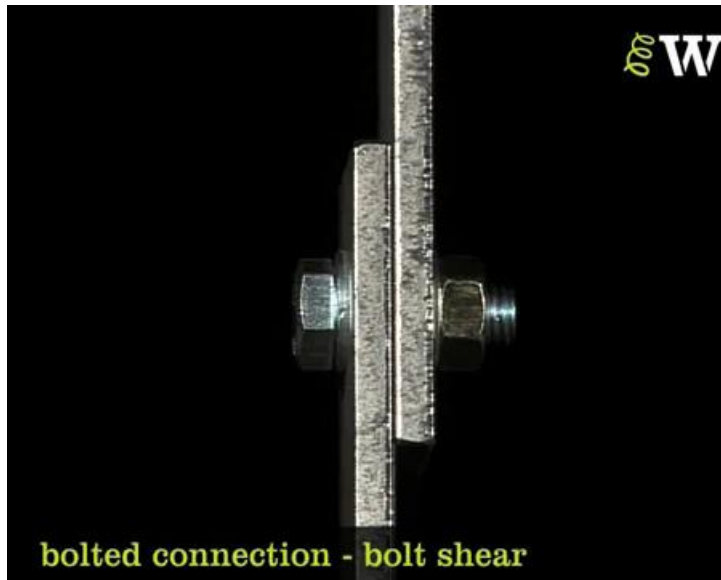

■ Here: No characterization of the failure itself

[videos: www.youtube.com/user/ExpeditionWorkshed]

■ Bolt grades and pre-tension forces

■ Pre-tension force based on yield stress

■ Application by tightening torque

44 TENSILE STRENGTH COMPARISON CHART STEEL / ALLOY BOLTS

INCH Fasteners		METRIC Fasteners	
Pounds per inch ²	(psi)	(MPa)	Megapascals
Grade 2 (over 3/4")	60000	414	class 4.6
Grade 2 (upto 3/4")	74000	510	class 4.8
	72519	500	class 5.6
	75420	520	class 5.8
	87023	600	class 6.8
Grade 5 (over 1")	105000	724	
Grade 5 (upto 1")	120000	827	
	120381	830	class 8.8
	130534	900	class 9.8
Grade 7	133000	916	
Grade 8	150000	1034	
	150839	1040	class 10.9
ASTM A574 (≤ 1/2" - 180,000 psi)	176946	1220	class 12.9
ASTM A574 (> 1/2" - 170,000 psi)			
L 9 [®] (Grade 9) (Proprietary product)	180000	1240	

Note: It has been customary that socket head cap screws produced in the US are always made from high strength alloy steel as indicated above (ASTM A574). The same practice does not apply in Europe where metric classes 10.9 & 8.8 are also available in addition to property class 12.9

45 COMMON WORKSHOP BOLTS IDENTIFICATION & MECHANICAL PROPERTIES

Identification Mark	Common INCH Steel Bolts			Stainless Steel	
	Grade 2	Grade 5	Grade 8	Soc. Hd. Cap Scr.	Stainless Steel
Product Specifications	Grade 2	Grade 5	Grade 8	Soc. Hd. Cap Scr.	Stainless Steel
Nominal Size Range	1/4 - 3/4 (> 3/4 - 1 1/2)	1/4 - 1 (> 1 - 1 1/2)	1/4 - 1 1/2 (> 1/2 - 2)	< 1/2 (> 1/2 - 2)	1/4 - 1 1/2
Material	Low/Med. Carbon Steel	Medium Carb. Steel Heat Treated	Medium Carb. Steel Heat Treated	Alloy Steel Heat Treated	Stainless Steel 304 / Stainless Steel 316
Tensile Strength Minimum [psi]	74000 (60000)	120000 (105000)	150000	180000 (170000)	85000 / 85000
Yield Strength Minimum [psi]	57000 (36000)	91000 (81000)	130000	162000 (153000)	45000 / 45000
Proof Load [psi]	55000 (33000)	85000 (74000)	120000	140000 (135000)	- / -
Hardness Min Max	HRB-70 / HRB-95	HRC-19 / HRC-34	HRC-33 / HRC-39	HRC-38 / HRC-45	HRB-80 / HRB-80
Compatible Nut	Mild Steel	Grade 5	Grade 8	-	304 / 316

Common METRIC Steel Bolts				
Identification Mark	4.6	5.8	8.8	10.9
Product Specification	Class 4.6	Class 5.8	Class 8.8	Class 10.9
Material	Low/Medium Carbon Steel	Low/Medium Carbon Steel Heat Treated	Medium Carbon Steel Heat Treated	Alloy Steel Heat Treated
Tensile Strength Minimum	400 MPa (58000 psi)	520 MPa (75000 psi)	830 MPa (120000 psi)	1040 MPa (150000 psi)
Yield Strength Minimum	240 MPa	420 MPa	640 MPa	940 MPa
Proof Load	220 MPa	380 MPa	600 MPa	970 MPa
Hardness Min Max	HRB-67 / HRB-95	HRB-82 / HRB-95	HRC-22 / HRC-34	HRC-32 / HRC-39
Compatible Nut	Class 5	Class 5	Class 8	Class 10

*Approximate Equivalent INCH / METRIC Bolts

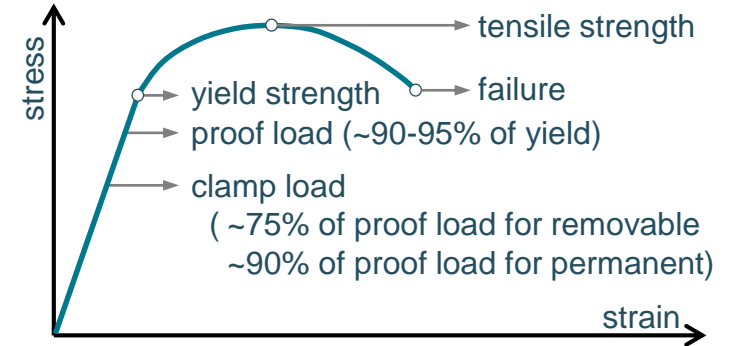

119 TIGHTENING TORQUE FOR METRIC BOLTS

Important Note: The tables below lists the maximum permissible tightening torques and the resulting maximum pre-load for standard hex head bolts & socket head cap screws based on 90% utilization of the bolt's yield strength. They do not include any safety factor and should be used with caution because the coefficient of friction μ is subject to many application variables & as a result, an entirely different pre-load figure would result (also refer page 39 & 78).
Coefficient of friction:
 $\mu = 0.14$ is for standard zinc plated bolts (dry)
 $\mu = 0.10$ is for standard black bolts (lubricated)

Bolt Diameter x Pitch	Thread Stress Area mm ²	*when $\mu = 0.10$		*when $\mu = 0.14$	
		results in		results in	
		Tightening Torque Nm	Pre-load kN	Tightening Torque Nm	Pre-load kN
M5 x 0.8	14.2	5.2	7.4	6.5	7.0
M6 x 1	20.1	9.0	10.4	11.3	9.9
M8 x 1.25	36.0	21.0	19.1	27.3	18.1
M10 x 1.5	58.0	43	30.3	54	28.8
M12 x 1.75	84.0	73	44.1	92	41.9
M14 x 2	115	117	60.6	148	57.5

[images: www.FastenerBlackBook.com]

Modeling Techniques for Pre-Tensioned Bolts in LS-DYNA

Overview of the “bolt types” used in this presentation

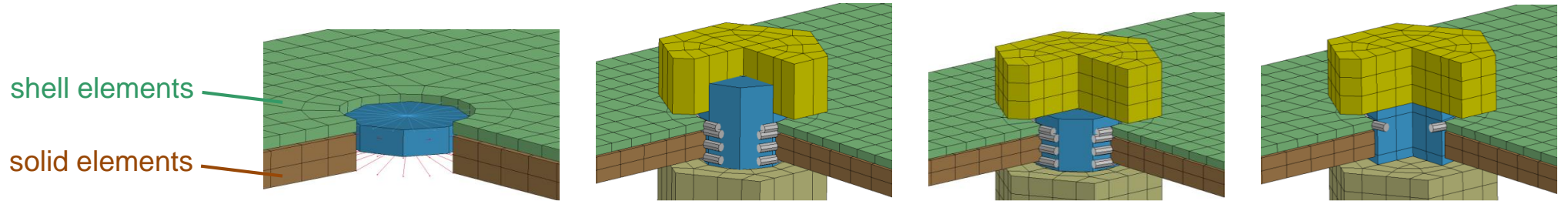

bolt type	a)	b)	c)	d)
shank discretization	spot weld beam	spot weld beam	spot weld beam	solid elements
shank material	*MAT_SPOTWELD	*MAT_SPOTWELD	*MAT_SPOTWELD	any (*MAT_024)
pre-stress/tension application	*INITIAL_AXIAL_FORCE_BEAM	*INITIAL_AXIAL_FORCE_BEAM	*INITIAL_AXIAL_FORCE_BEAM	*INITIAL_STRESS_SECTION
head / nut discretization	nodal rigid body or beam spider	shell elements	solid elements	solid elements
contact beam on shank	no	yes & no (depends on contact card)	yes & no (depends on contact card)	not necessary
contact beams @ shell plate	no	yes & no (depends on contact card)	yes & no (depends on contact card)	yes & no (contact)
contact beams @ solid plate	no	yes & no (depends on contact card)	yes & no (depends on contact card)	not necessary

Review of contact definitions

- *CONTACT_AUTOMATIC_SINGLE_SURFACE
 - “Classic” node to segment penetration check

CPU contact w. R10.1: 3.2 s [100%]

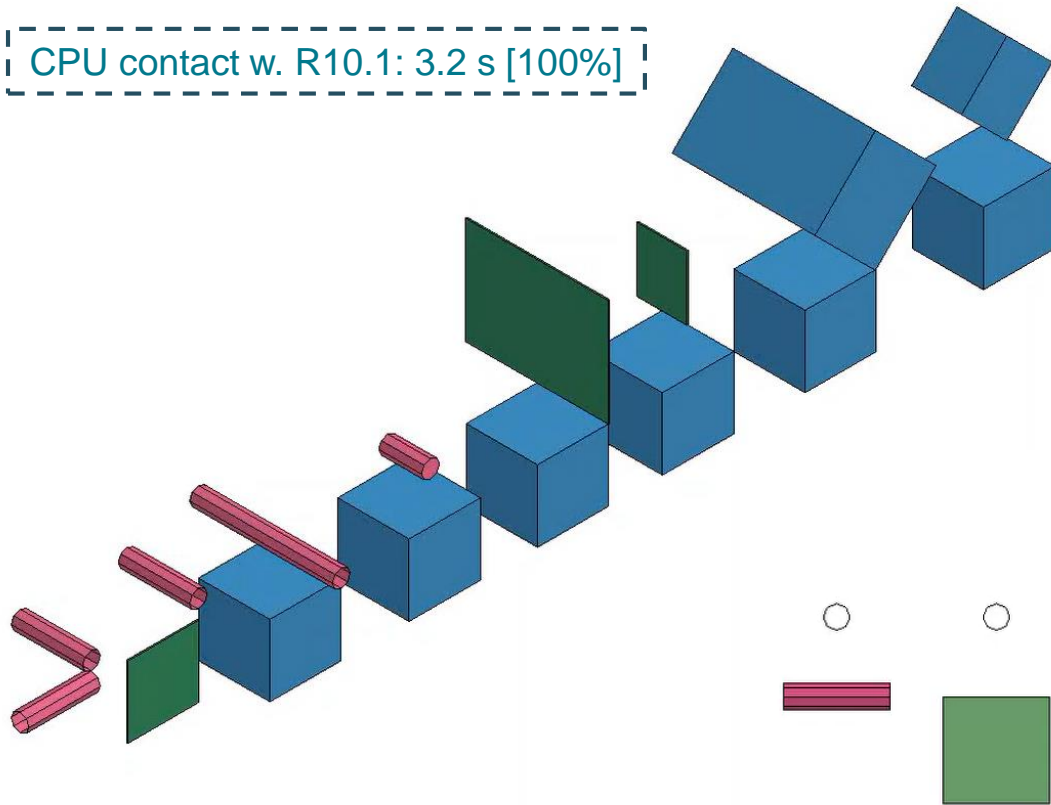

Captured contact situations

- Nodes not allowed to penetrate segments
 - Segment extension on nodes of shell edge

Missed contact situations

- Beam to beam
- Beam to shell edge
- Beam to segment of shell and solid
- Shell edge to segment of shell and solid
- Solid edge to segment of shell and solid

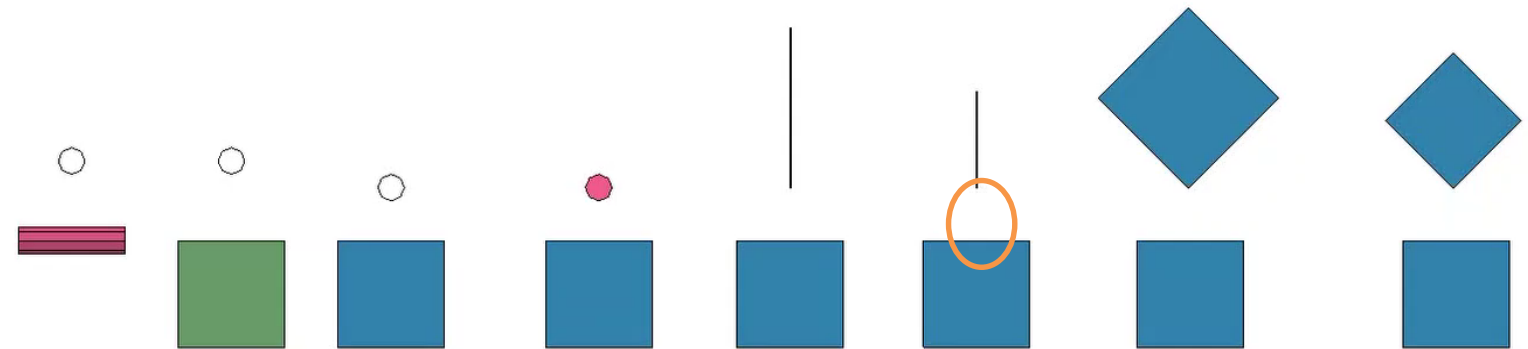

Review of contact definitions

- *CONTACT_AUTOMATIC_SINGLE_SURFACE
 - Now SOFT=2 : segment-based penetration check

CPU contact w. R10.1: 2.7 s [84%]

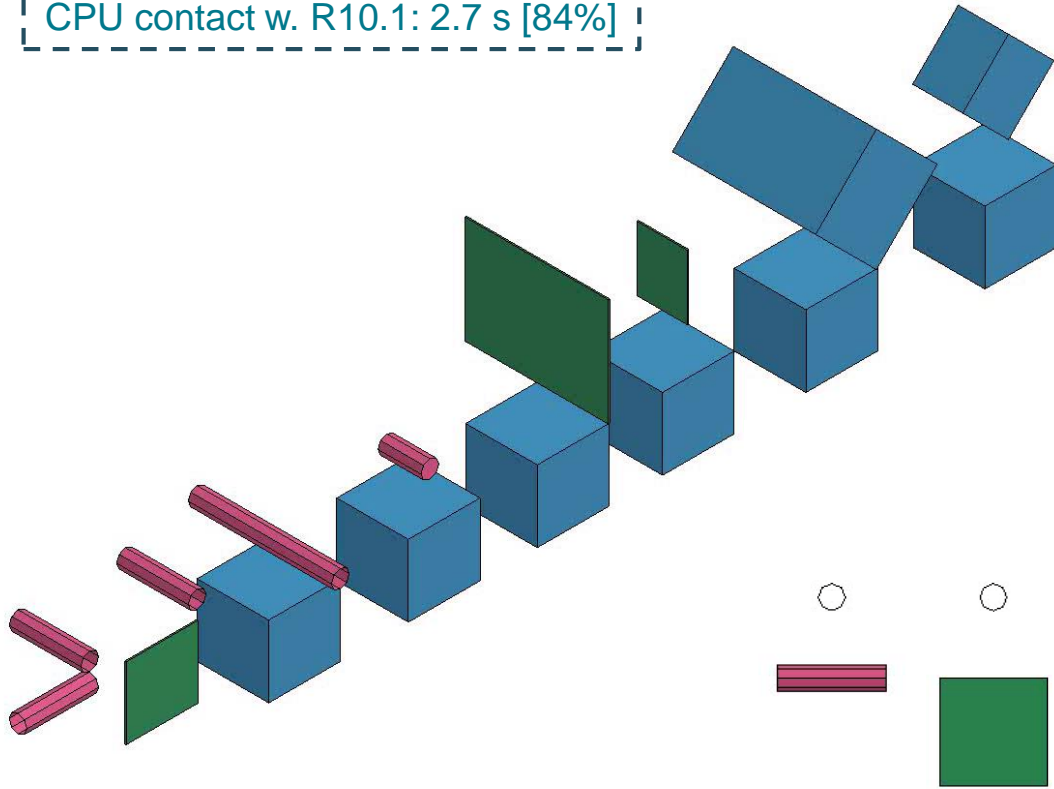

■ Captured contact situations

- Segments not allowed to penetrate segments
 - Shell edge to segment of shell and solid
 - Solid edge to segment of shell and solid

■ Missed contact situations

- Beam to beam
- Beam to shell edge
- Beam to segment of shell and solid
 - Also when beam nodes are “on segment”

Review of contact definitions

- *CONTACT_AUTOMATIC_SINGLE_SURFACE
 - Now SOFT=2 : segment-based penetration check
 - No segment extension on shell edge
(*CONTROL_CONTACT, SHLEDG=1)

CPU contact w. R10.1: 2.6 s [81%]

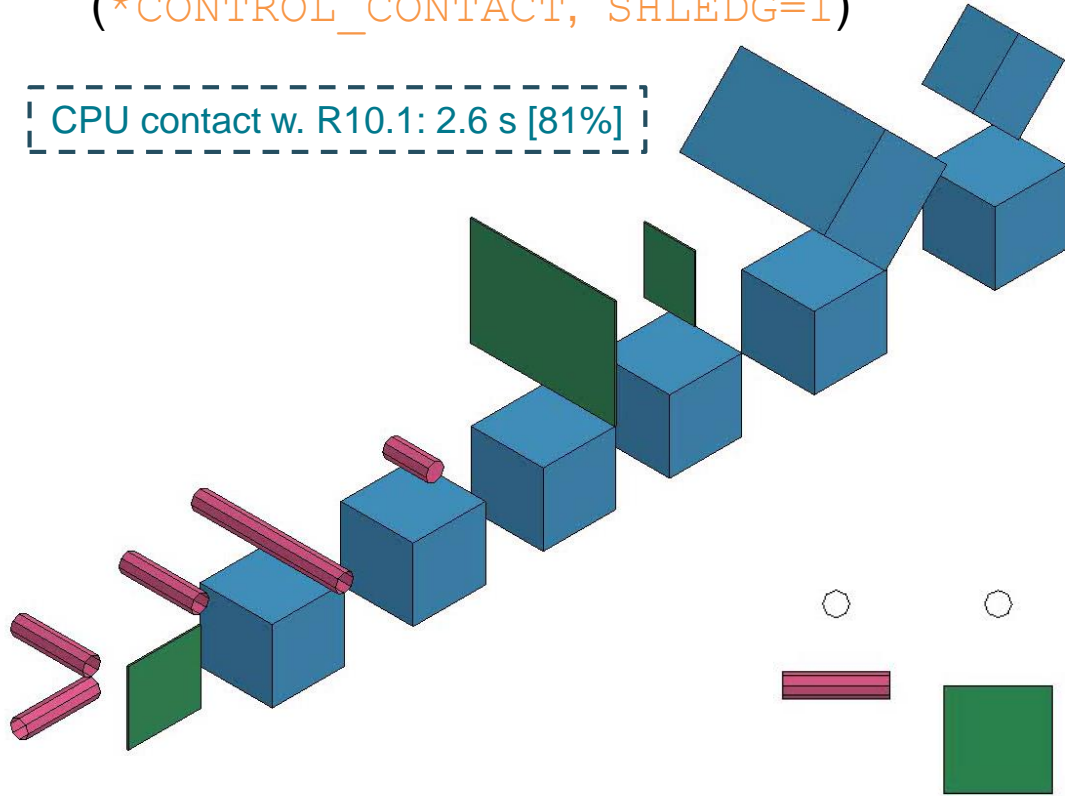

■ Captured contact situations

- Segments not allowed to penetrate segments
 - Shell edge to segment of shell and solid
 - Solid edge to segment of shell and solid

■ Missed contact situations

- Beam to beam
- Beam to shell edge
- Beam to segment of shell and solid
 - Also when beam nodes are “on segment”

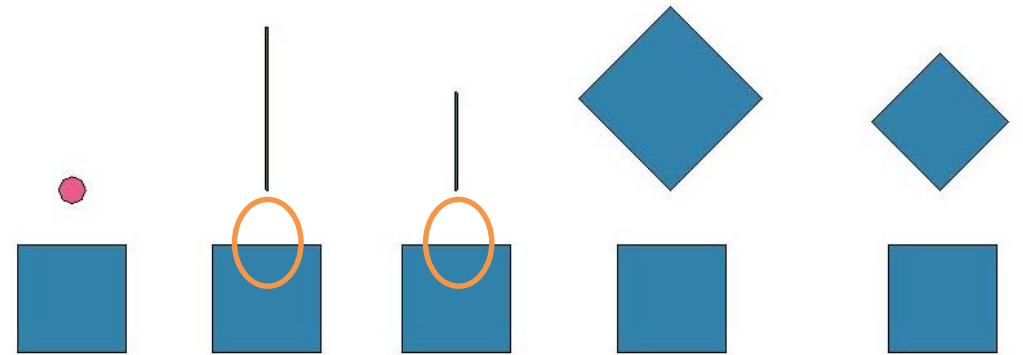

Review of contact definitions

- *CONTACT_AUTOMATIC_GENERAL
 - “Classic” node to segment penetration check
 - Enhanced by beam to beam penetration check
 - Shell edges treated as beams

CPU contact w. R10.1: 5.4 s [169%]

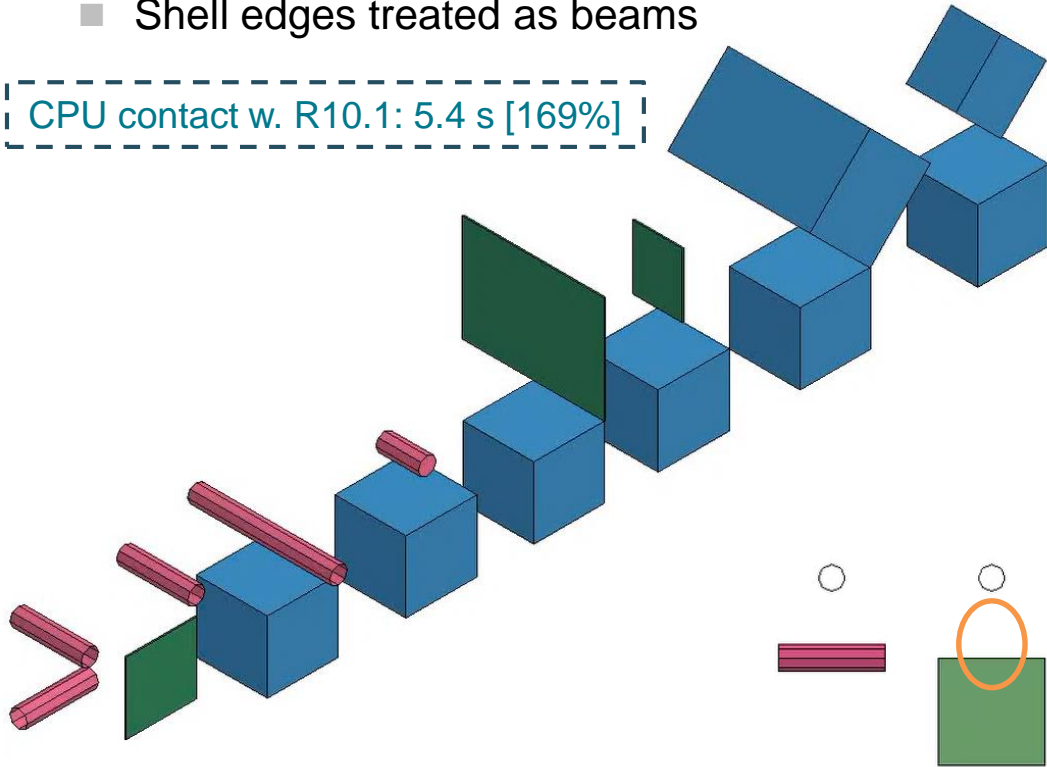

Captured contact situations

- Nodes not allowed to penetrate segments
- Beam to beam
- Beam to shell edge (**segment extension!**)

Missed contact situations

- Beam to segment of solid (but shell works)
- Shell edge to segment of solid (but shell works)
- Solid edge to segment of solid

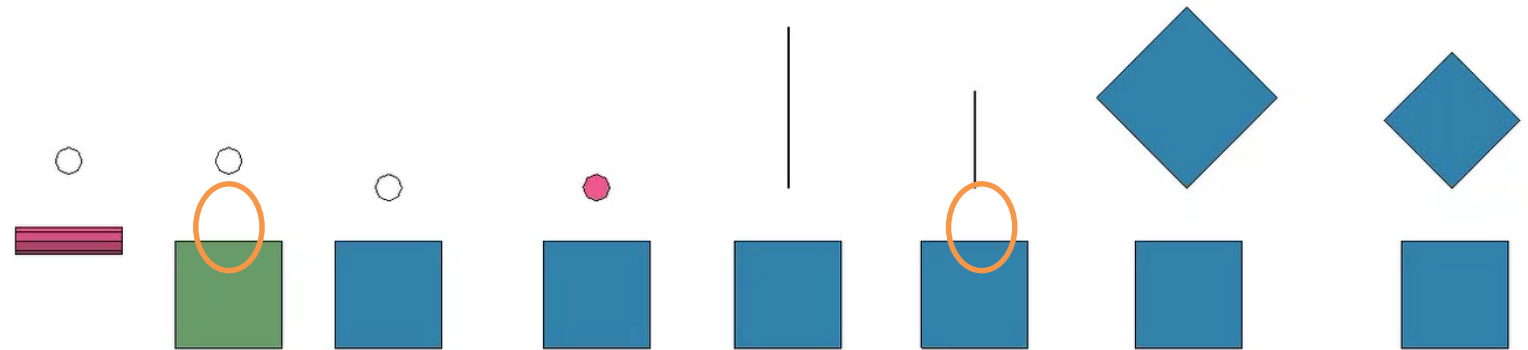

Review of contact definitions

- *CONTACT_AUTOMATIC_GENERAL_EDGEONLY
 - Only beam to beam penetration check
 - Switched off node to segment penetration check

CPU contact w. R10.1: 5.5 s [172%]

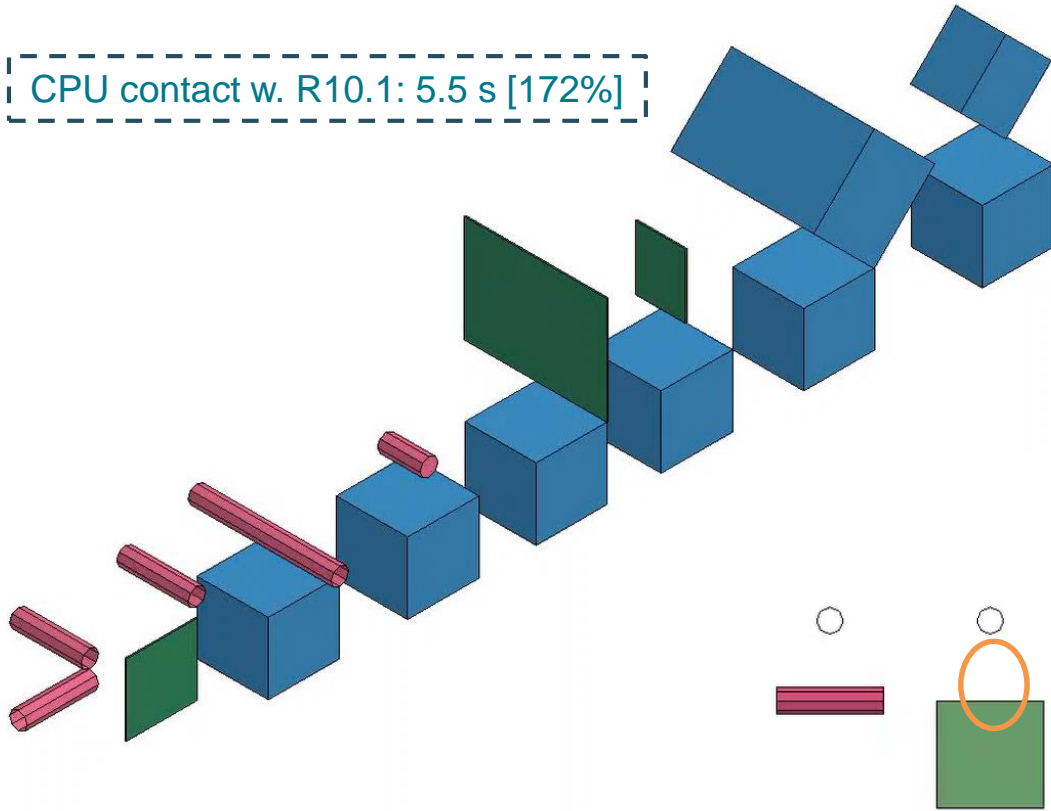

Captured contact situations

- Beam to beam
- Beam to shell edge (**segment extension!**)

Missed contact situations

- Nodes not allowed to penetrate segments
- Beam to segment of shell and solid
- Shell edge to segments of shells and solids
- Solid edge to segments of shells and solids
- **No spot weld beam (eltyp=9) → use _MPP**

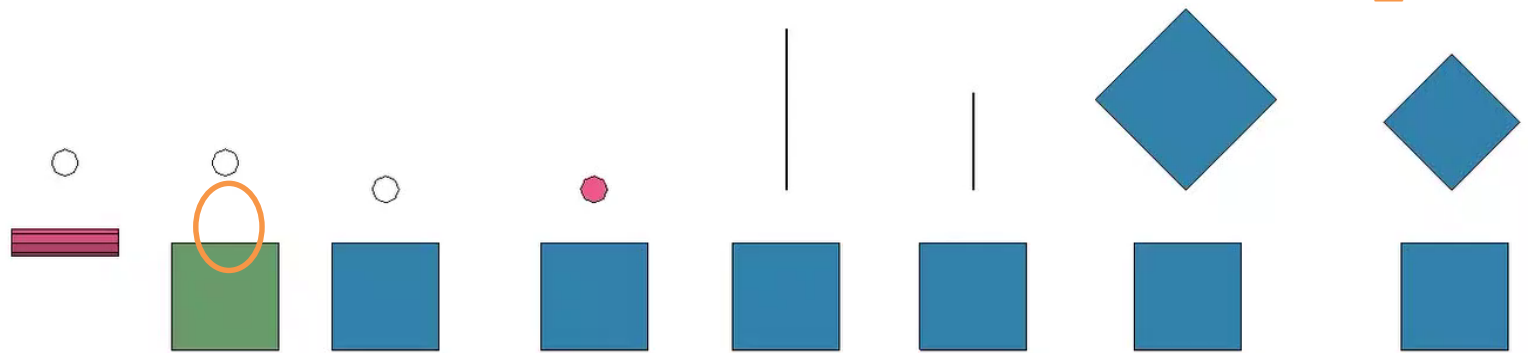

Review of contact definitions

■ *..._AUTOMATIC_SINGLE_SURFACE_MORTAR

- Segment-based penetration check

CPU contact w. R9: 326 s [13057%]
R10.1: 83 s [2606%]

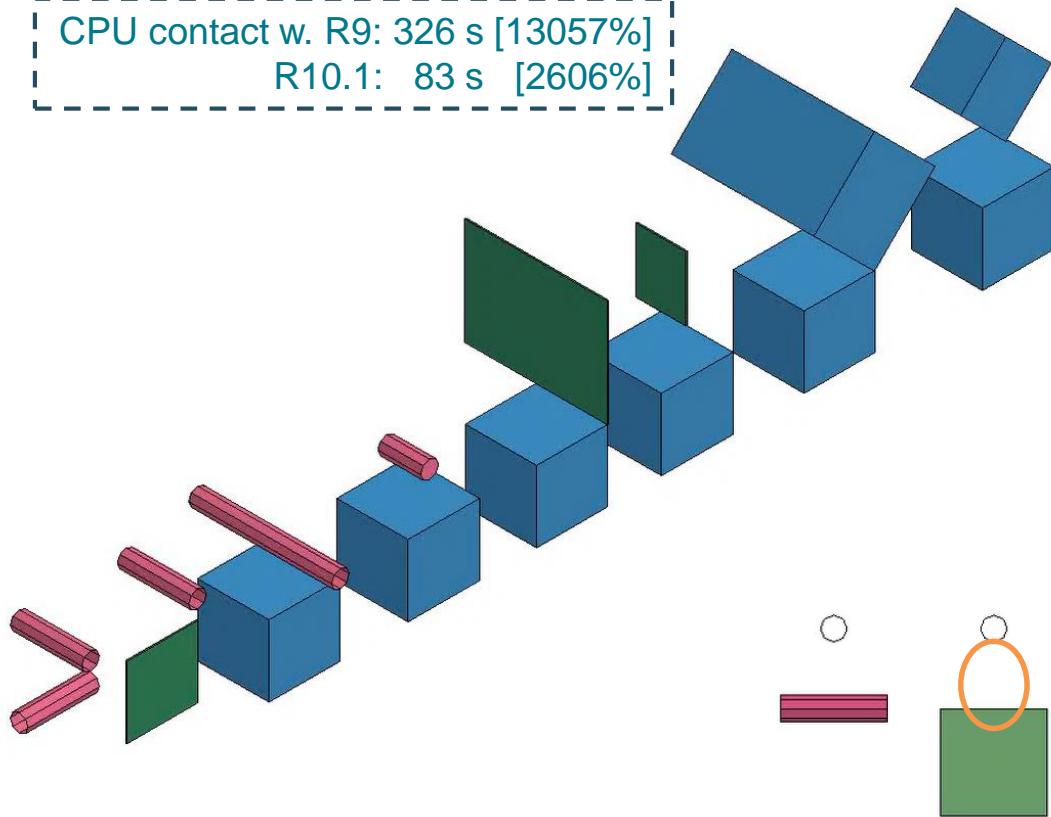

■ Captured contact situations

- Segments not allowed to penetrate segments
 - Shell edge to segment of shell and solid
 - Solid edge to segment of shell and solid
- Beam to beam
- Beam to shell edge (**NO segment extension!**)
- Beam to segment of shell and solid

■ Missed contact situations

- None (since recently also spot weld beams)

Bolt type a)

■ General remarks

- Simplest way to add pre-tension to a friction grip bolt connection
- Spot weld beam of shaft is connected via rigid or deformable beam spider
- No additional contact needed besides `*CONTACT_AUTOMATIC_SINGLE_SURFACE`

■ Explicit vs. implicit time integration

- The `_MORTAR` option is typically advised to use in implicit simulations

■ Merits and drawbacks

- Usually only good within the service load regime
- Above service loads, slipping between sheets and head/nut is missed
- Rigid beam spiders influence stress wave propagation
- For connection of three sheets with slipping motion, refer to bolt type b)
- Failure probably not well captured

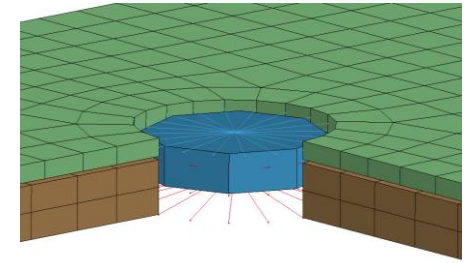

Bolt type b)

■ General remarks

- More detailed method to model friction grip bolt connections
- Possibility to predict slipping beyond service load and even failure
- Sheets Head, nut and washers in `*CONTACT_AUTOMATIC_SINGLE_SURFACE`
- If hole bearing behavior is of interest a special contact is needed
 - `*CONTACT_AUTOMATIC_GENERAL`
 - Needs contact null beam with `*MAT_NULL` on spot weld beam
 - Needs contact null beams at the perimeter of the hole
 - to limit the usage of this more expensive contact definition
 - exhibits beam-to-beam self contact of contact null beams when in same part ID
 - `*CONTACT_AUTOMATIC_GENERAL_MPP`
 - No need for contact null beam on top of spot weld beam, if `CPARM8=2`
 - Contact null beams at the perimeter of the hole are still advised
 - to limit usage of more expensive contact
 - `CPARM8=1` or `2` excludes beam-to-beam self contact from the same part ID

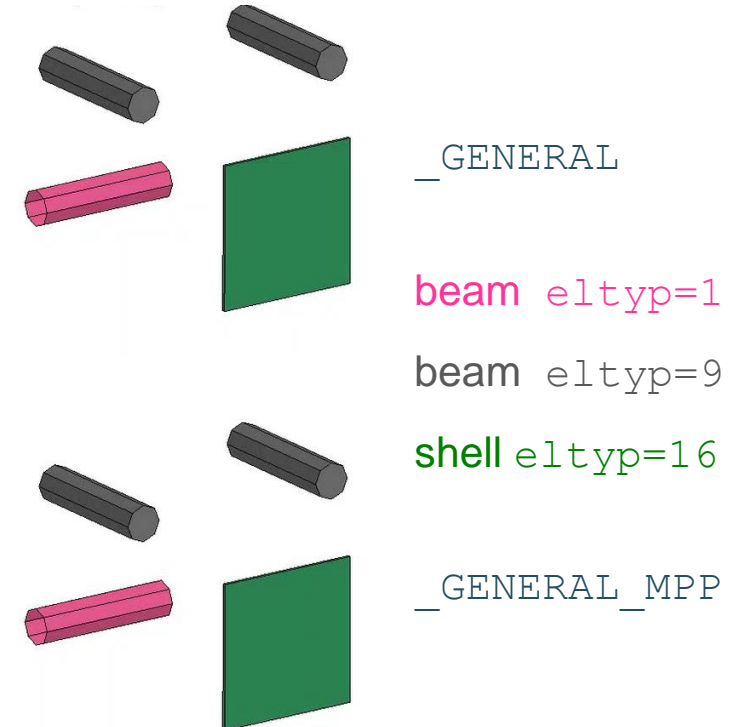
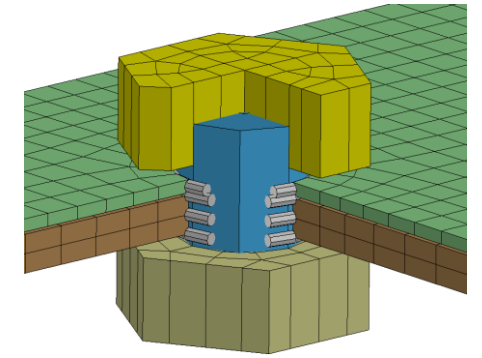

Bolt type b) – cont'd

■ Explicit vs. implicit time integration

- The `_MORTAR` option is typically advised to use in implicit simulations
 - In theory, no contact null beams are needed
 - In practice, contact null beams are still modeled
 - Mortar contact stiffness is smaller on shell edges
 - Mortar contact has no segment extension of shells
 - Without null beams, the bolt hole is bigger and slip may be greater
 - Keep contact null beams to keep comparability to explicit simulations

■ Merits and drawbacks

- Usually also good beyond the service load regime during slip
- Bolt shear failure might be difficult to predict with a single spot weld beam element
- Flat shell element topologies like the head and the nut are not able to connect the shank with torsion
 - Drilling rotation constrained automatically switched on in implicit to avoid unconstrained degrees of freedom
- Shells of the head and the nut have a segment extension which might bother in detailed models

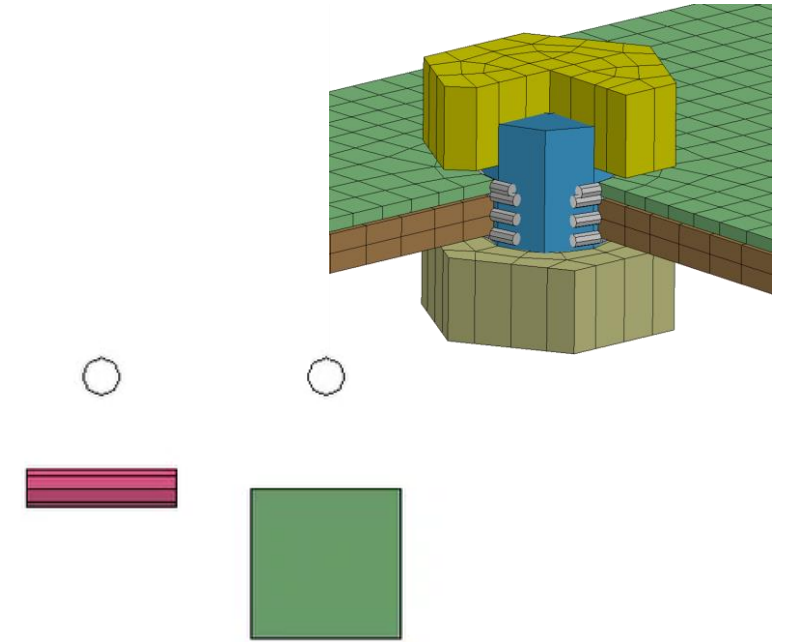

Bolt type c)

■ General remarks

- Shank and bolt hole modeled as in type b)
 - Same special contact treatment to capture hole bearing
- Head and nut modeled with solids instead of shells elements
 - Solids lack rotational degrees of freedom and there is no drilling rotation constraint to connect spot weld beam
 - Head and nut modeled as rigid bodies
 - LS-DYNA takes care of fixing rotations in explicit and implicit simulations
 - Head and nut modeled as deformable bodies
 - Beam spider should be used to connect spot weld beam to the solid elements

■ Explicit vs. implicit time integration

- As in type b), the `_MORTAR` option is advised in implicit simulations together with contact beams
- Use beam spider to connect spot weld beam with deformable head & nut to avoid singular stiffness matrix

■ Merits and drawbacks

- Similar as for type b) → might go the extra mile and model type d)

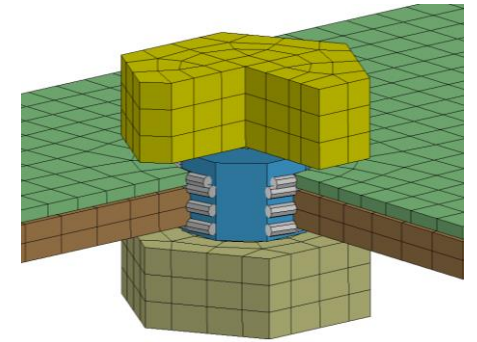

Bolt type d)

■ General remarks

- Shank, head and nut are meshed with solid elements
 - Typical are hexahedron elements only or in combination with some pentahedrons
 - Tetrahedrons should be always avoided
 - Sharing nodes or tied contact between head or nut and shank
- Three common ways to define contact between shaft and bolt hole
 - `*CONTACT_AUTOMATIC_GENERAL` or `*CONTACT_AUTOMATIC_GENERAL_MPP` with `CPARM8=2`
 - Achieve bolt hole sizes consistent with bolt types a) – d), i.e. diameter is enlarged by contact null beam diameter
 - Contact null beams at hole perimeter (not necessary) can be included when converting from bolt types a) – d)
 - `*CONTACT_AUTOMATIC_SINGLE_SURFACE` with `SOFT=2` (segment based contact)
 - Achieve bolt holes with segment extension at shell edge
 - Usually meshed bolt hole size consistent with bolt types a) – d), i.e. diameter is enlarged by shell thickness
 - `*CONTACT_AUTOMATIC_SINGLE_SURFACE` with `SOFT=2` and `SHLEDG=1` in `*CONTROL_CONTACT`
 - Mesh has bolt holes with the diameter they actually have, i.e. no segment extension at shell edge (convenient!)
 - Bolt hole size directly compatible to the `__MORTAR` contact option when using implicit LS-DYNA

used in
this paper

commonly
used

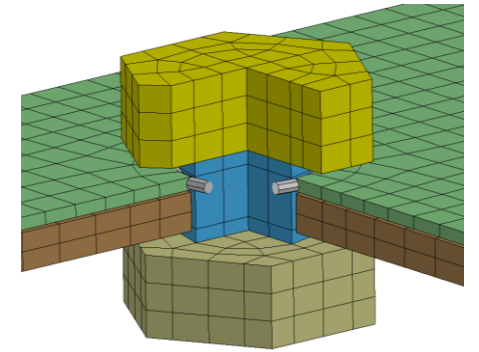

Bolt type d)

■ Explicit vs. implicit time integration

- As in type b), the `_MORTAR` option is advised in implicit simulations
- Contact null beams can be included
 - Keep compatibility to explicit models which have them included
- Works also without contact null beams
 - Keep compatibility to explicit model with `SOFT=2` and `SHLEDG=1`

■ Merits and drawbacks

- Bolt failure can be captured well with fine enough mesh
 - Almost all material models can be used with `MAT_ADD_EROSION`
- Bolt pre-tension is applied as stress versus an applied force in case of the spot weld beam
 - To compare with types a)-c), make sure to convert with the right cross section area

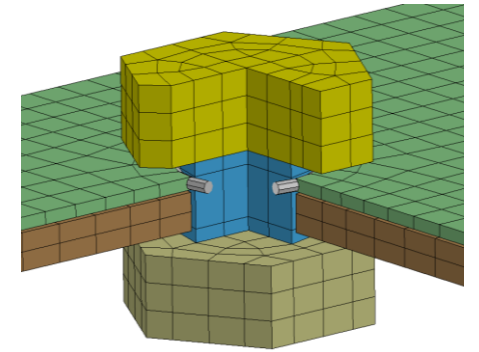

Initializing the Pre-Tension in the Bolt

Shanks modeled with spot weld beam elements

■ Initialization of a normal force as pre-tension in the spot weld beam

```
*INITIAL_AXIAL_FORCE_BEAM
$#   bsid      lcid      scale      kbend
     100      100
*DEFINE_CURVE
$#   lcid      sidr      sfa      sfo      offa      offo      dattyp      lcint
     100          &dtPreStr &BltForce
$#          a1          o1
          0.0          0.0
          1.0          1.0
```

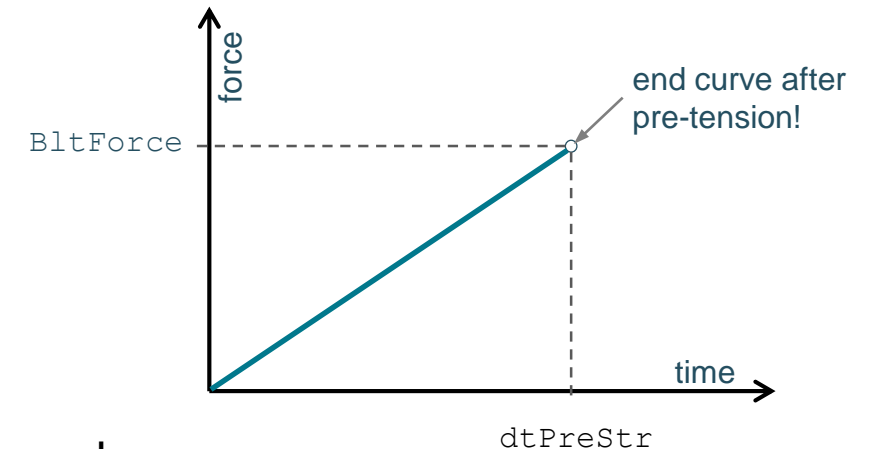

- `bsid`: beam set ID containing the spot weld beams to be pre-tensioned
- `dtPreStr`: parameter defining the initialization time of the pre-tension
- `BltForce`: parameter defining the pre-tension force
- Bending stiffness of bolt during initialization
 - `kbend=0`: no bending stiffness
 - `kbend=1`: beam has bending stiffness (starting with R10)

Shanks modeled with solid elements

■ Initialization of a normal stress in a cross section of the solid elements

```
*INITIAL_STRESS_SECTION
$#  issid    csid    lcid    psid    vid    izshear
    100     100     100     100     100     2
*DEFINE_CURVE
$#  lcid    sidr    sfa    sfo    offa    offo    dattyp    lcint
    100          &dtPreStr &BltStrss
$#          a1          o1
          0.0          0.0
          1.0          1.0
*DATABASE_CROSS_SECTION_PLANE_ID
$#  csid          title
    100 Cross Section Bolt
$#  psid    xct    yct    zct    xch    ych    zch    radius
    100          -1.6          0.6          5.5
$#  xhev    yhev    zhev    lenl    lenm    id    itype
```

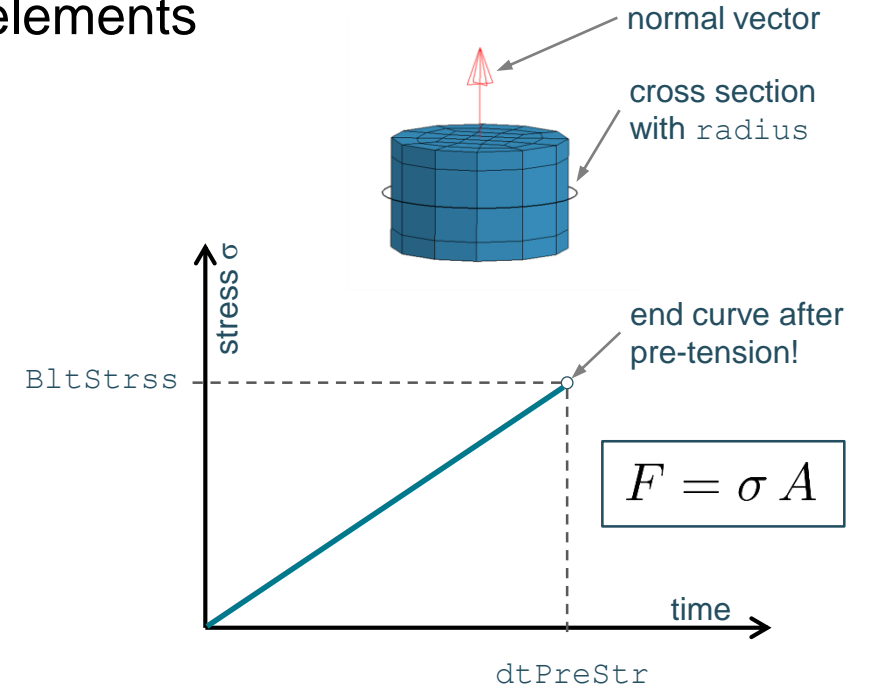

- `psid`: part set ID containing the solid elements to be pre-stressed
- `{x,y,z}ct {x,y,z}ch`: head and tail coordinate of normal vector of the cross section
- `BltForce`: radius of a circular cross section (provide reasonable value!)
- `izshear`: flag to activate shear stiffness during pre-stressing phase (was revised for R11)

Shanks modeled with solid elements – *cont'd*

- `izshear`: Allow shear stresses to develop during the pre-stressing phase
 - Yields more realistic distribution of the normal stresses
 - Normal stress distribution in the bolt at equilibrium using LS-DYNA implicit (R11)
 - `izshear=0`: yields homogeneous normal stress of 0.38 GPa
 - `izshear=2`: yields inhomogeneous normal stresses averaging 0.38 GPa over the cross section

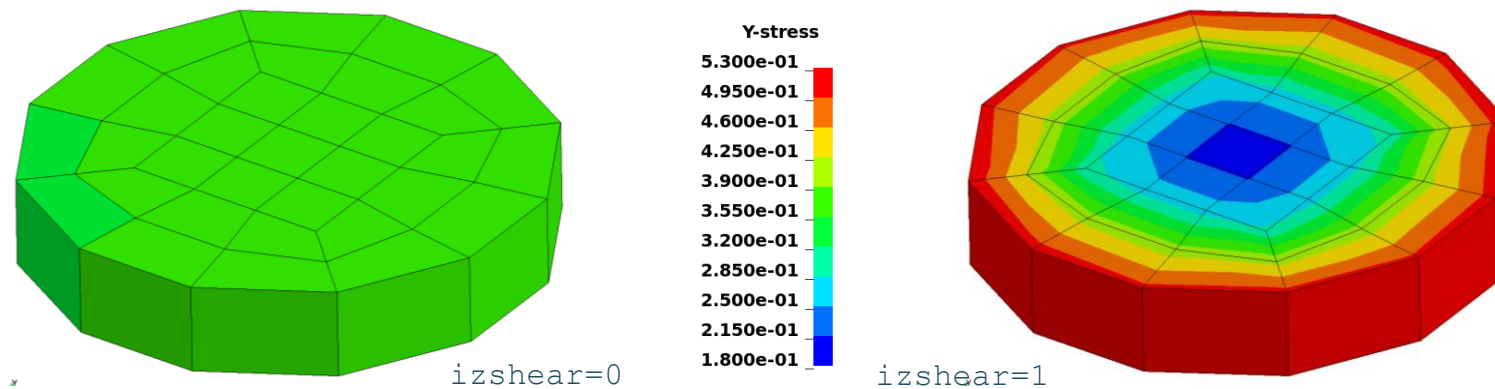

- Revised for implicit in current developer versions (SVN>123041, including R11 branch)
 - For explicit analysis this will be available as `izshear=2` as of R11 (due to backward compatibility reasons)
 - For implicit `izshear=1` and `izshear=2` are synonymous

Shanks modeled with solid elements – *cont'd*

- Avoid pentahedron elements in the shank
 - Normal stress distribution might be disturbed
 - Cause convergence problems during implicit simulations with some LS-DYNA releases (R9.2, R10)

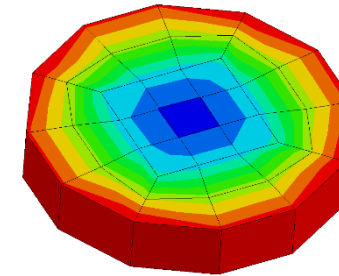

hexahedrons only

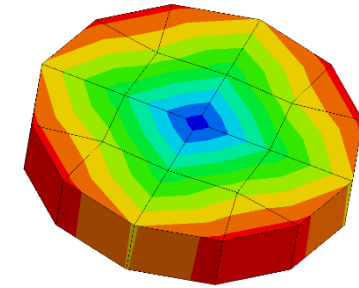

hexas & pentahedrons

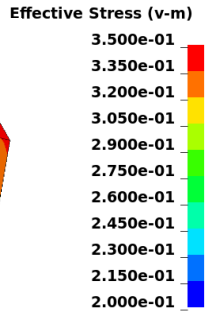

- Allow for large enough elements to account for initial contraction
 - Elements with a pre-stress application “shrink” until equilibrium is reached
 - Head and nut need to travel far enough to be in contact with the sheets
 - Best to account for this such that the deformed configuration leads to a nice mesh

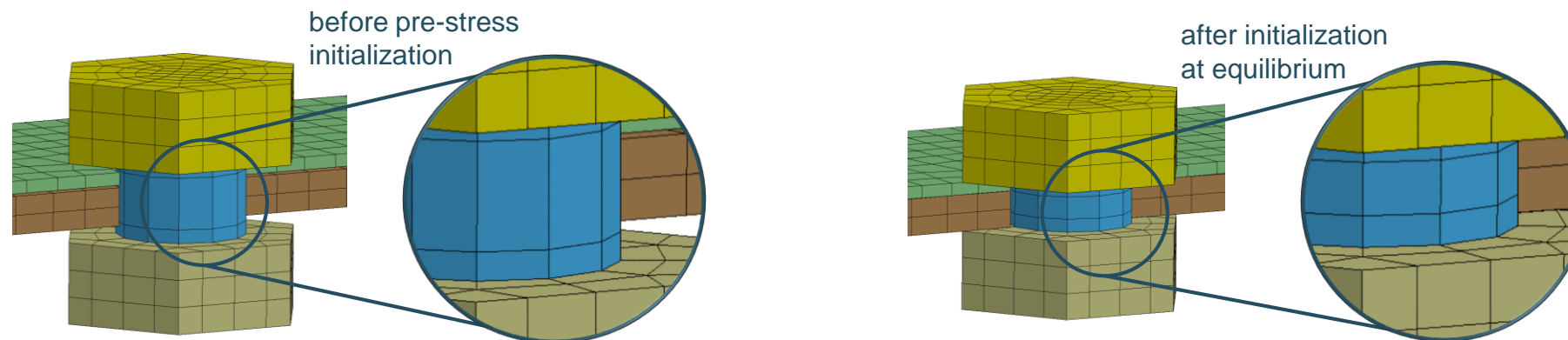

General rules of thumb during pre-stress initialization

- Initial gap size
 - The smaller the gap the better!
 - Head and nut impact causes
 - Stress waves in the rest of the model (noise)
 - Convergence problems in implicit simulations
- Skew bolt shaft
 - Can cause an initial slip of the connection
 - Bolt may end up tilted causing
 - Stress concentration
 - Reduction in clamping force
- Forgot to define the right friction in the contact card?
 - Here: static friction of 0.1

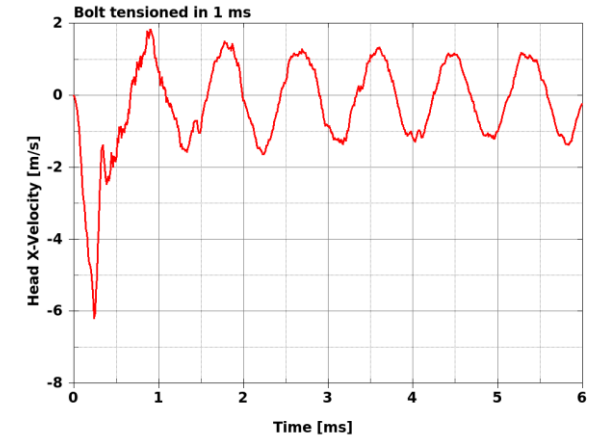
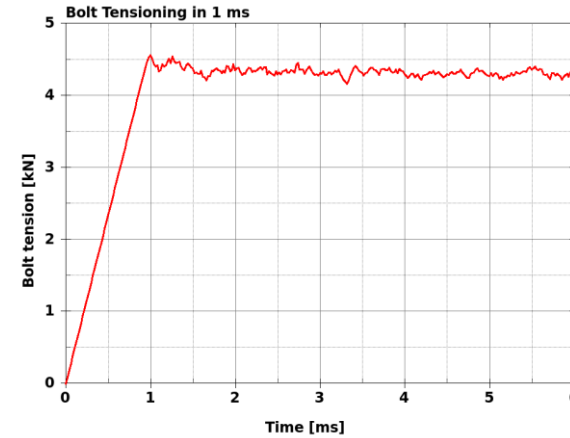

Time = 0

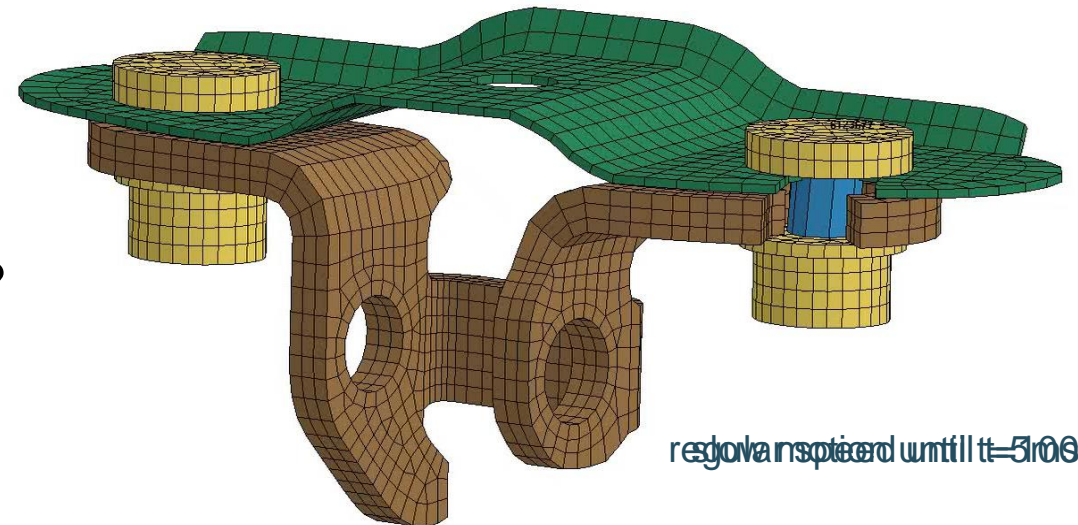

response until t=500ms

General rules of thumb during pre-stress initialization

■ Pre-stress application time

- If the tension initialization ends before equilibrium is reached, the desired bolt force is not reached

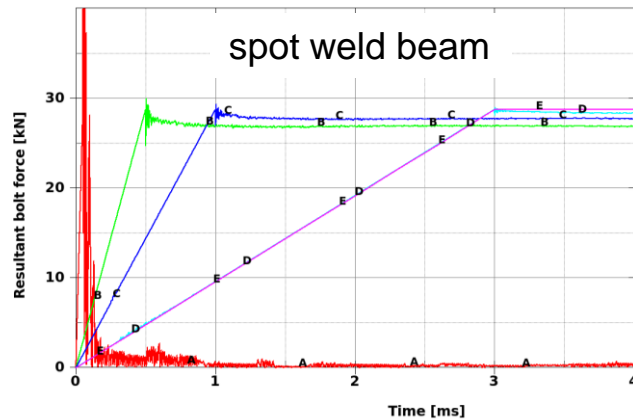

pre-tensioning times

- A Expl. 0.1 ms
- B Expl. 0.5 ms
- C Expl. 1.0 ms
- D Expl. 3 ms
- E Impl. 3 ms

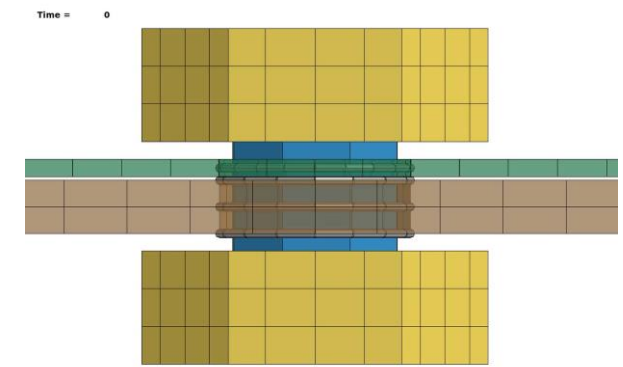
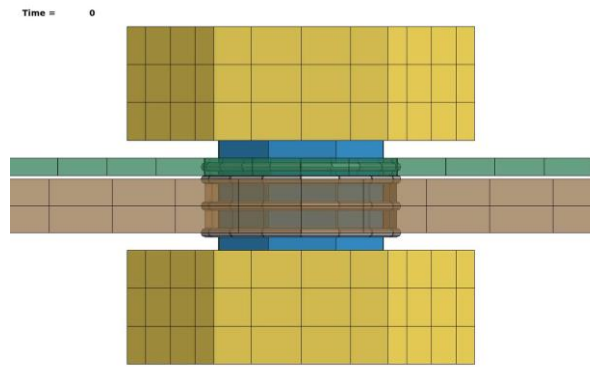
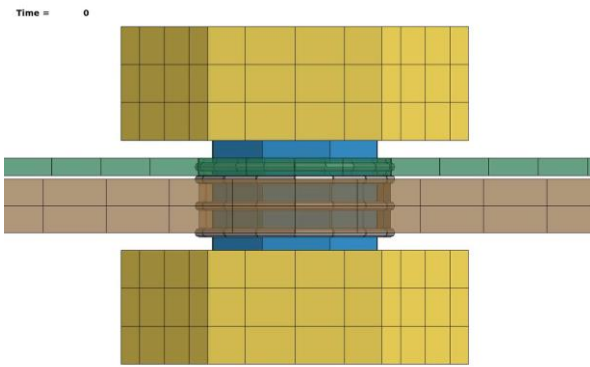
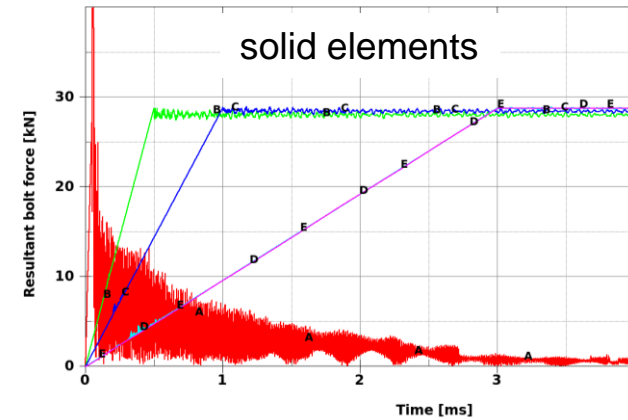

Bolts Modeled with LS-DYNA / Implicit

Perform static or dynamic simulation?

- Start with dynamic simulation to avoid matrix singularities
 - Initially the bolt is loose which leads to unconstrained rigid body modes (bad for convergence)
 - Damped Newmark scheme will help convergence greatly – calms the system during pre-tensioning
- Switch to static simulation after bolt is pre-tensioned
 - Over time, dynamic effects can be removed to fully calm the system
- Dynamic parts may be switched back on, if needed (i.e. slipping with loads beyond service loads)

```
*CONTROL_IMPLICIT_DYNAMICS
$#   imass      gamma      beta      tdybir      tdydth      tdybur      irate      alpha
      -42      0.60      0.38000
*DEFINE_CURVE
$#   lcid      sidr      sfa      sfo      offa      offo      dattyp      lcint
      42
$#           a1           o1
           0.0           1.0
           &dtPreStr       1.0      } dynamic
           2.0*&dtPreStr  0.0      } transition to static
(           &tLoad       1.0) ... optional to switch dynamics back on
```

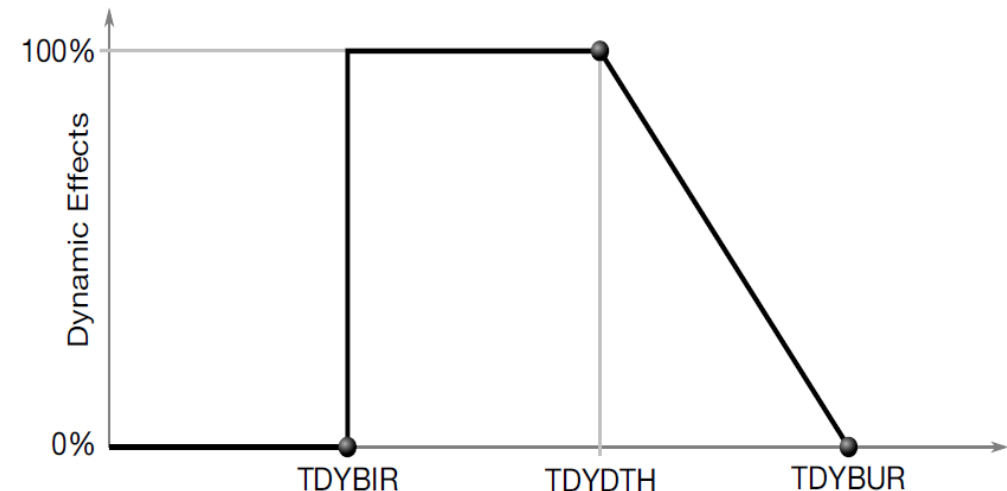

General implicit settings

■ General nonlinear solver settings

```
*CONTROL_IMPLICIT_GENERAL
$#  imflag      dt0      imform      nsbs      igs      cnstn      form      zero_v
      1          &dt0
*CONTROL_IMPLICIT_SOLUTION
$#  nsolvr      ilimit      maxref      dctol      ectol      rctol      lstol      abstol
      12          6          12          1          1          1          1.0e-20
$#  dnorm      diverg      istif      nlprint      nlnorm      d3itctl      cpchk
      1          1          3          4          1
$#  arcctl      arcdir      arclen      arcmtl      arcdmp      arcpsi      arcalf      arctim
$#  lsmtl      lsdir      irad      srad      awgt      sred
```

- imflag: implicit/explicit analysis type
- dt0: initial time step size
- abstol: remove absolute tolerance
- d3itctl: output convergence to d3iter

- nsolvr: recommended nonlinear solver
- ilimit: Iteration limit between automatic stiffness reformations (problem dependent)
- maxref: Stiffness reformation limit per time step (problem dependent)
- dnorm: displacement norm increment for convergence as a function of displacement over current step
- nlnorm=4: consider sum of translational and rotational degrees of freedom

Auto time step size and key points

Automatic time step size control

```

*CONTROL_IMPLICIT_AUTO
$#   iauto   iteopt   itewin   dtmin   dtmax   dtexp   kfail   kcycle
      1      40      10      -24
*DEFINE_CURVE
$#   lcid     sidr     sfa     sfo     offa     offo     dattyp   lcint
      24
$#           a1           o1
      &dtPreStrss       &dtMax
      &tLoad           &dtMax
    
```

- `iauto`: flag to switch on/off automatic time step control
- `itopt`: optimal number of iterations
- `itwin`: optimal iteration bandwidth
- `dtmin`: lower time step boundary (default $dt_0/1000$)
- `dtmax`: upper time step boundary (< 0 it's a curve ID with key points)

Definition of key points

- Important points in time that need to be reached exactly

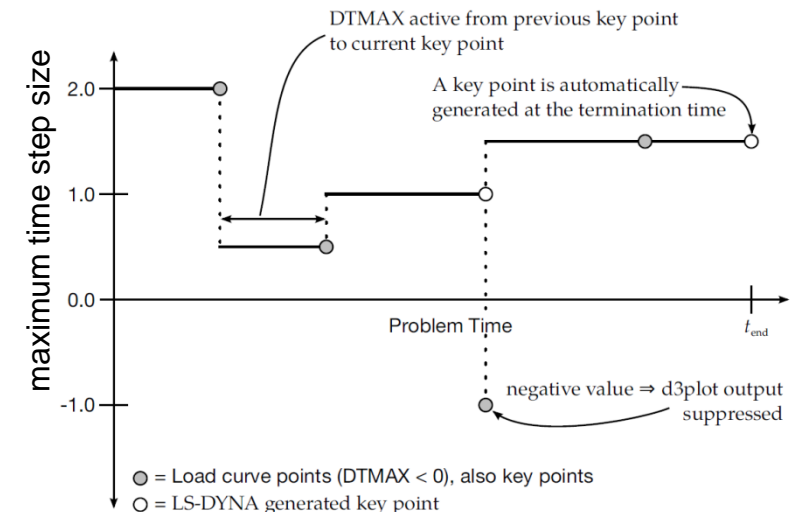
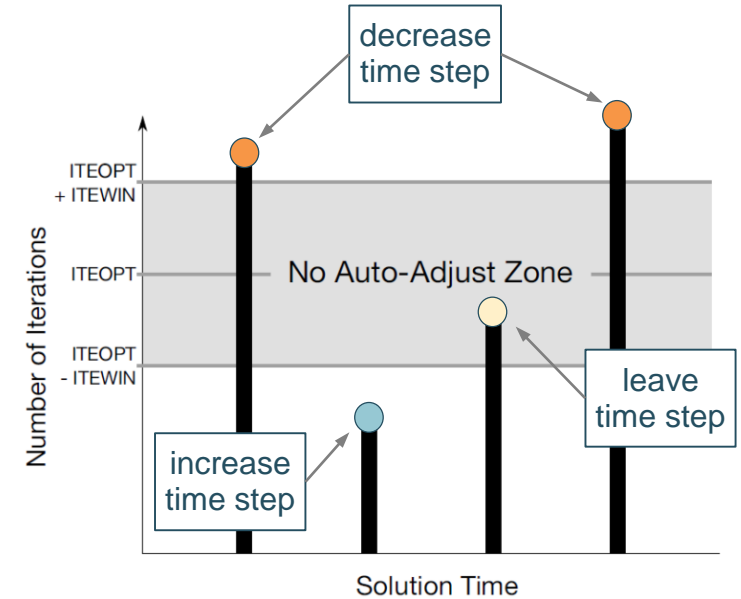

Presented Example for Bolt Types a) to d)

Boundary conditions

■ Boundary conditions

■ Bolt pre-tension

- Spot weld beam: $F = \sigma A = 28.8 \text{ kN}$
- Solids: $\sigma = 0.3841 \text{ GPa}$ $A = 74.9859 \text{ mm}^2$
- Here: solid pre-stress yields equivalent pre-tension

■ Displacement u_x on one side

■ Fixed in space on other side

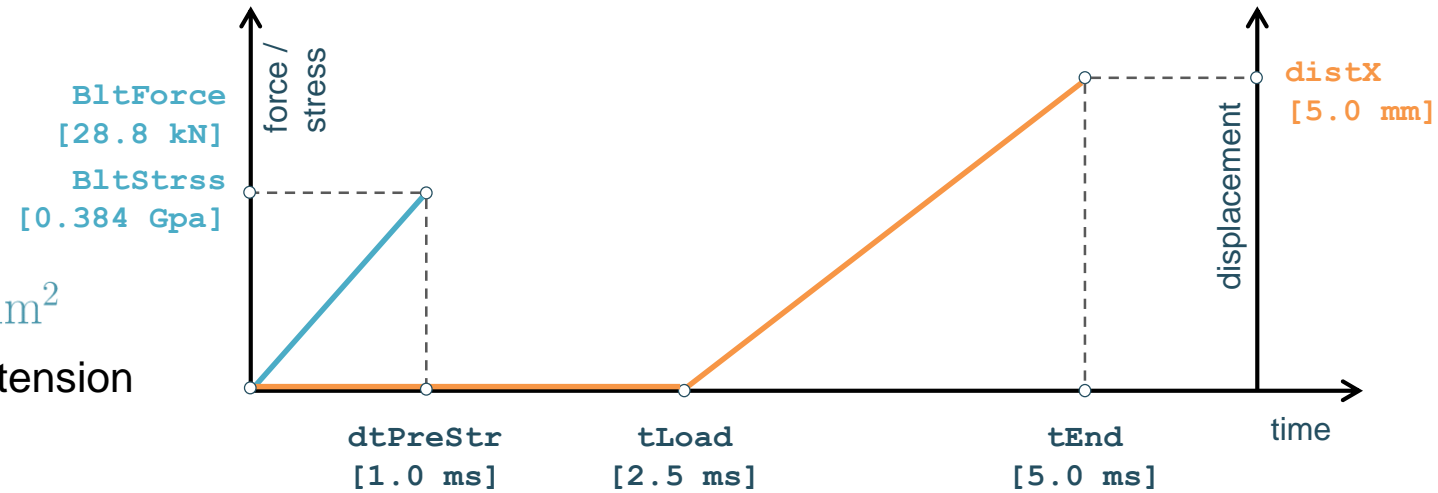
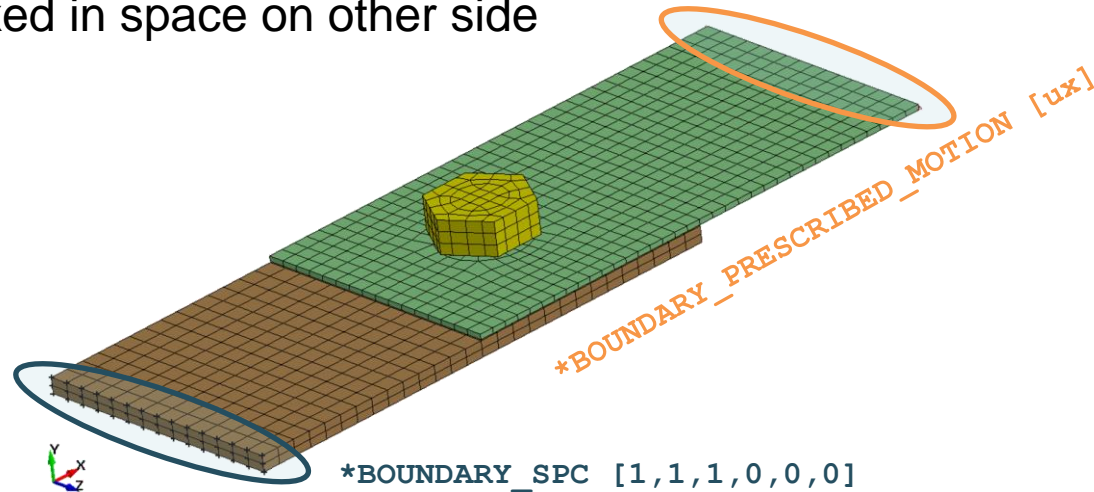

Tightening Torque for Class 4.6 Bolts (METRIC COARSE)					
Bolt Diameter x Pitch	Thread Stress Area mm ²	*when $\mu = 0.10$		*when $\mu = 0.14$	
		Tightening Torque Nm	Pre-load kN	Tightening Torque Nm	Pre-load kN
M5 x 0.8	14.2	5.2	7.4	6.5	7.0
M6 x 1	20.1	9.0	10.4	11.3	9.9
M8 x 1.25	36.6	21.6	19.1	27.3	18.1
M10 x 1.5	58.0	43	30.3	54	28.8
M12 x 1.75	84.3	73	44.1	93	41.9
M14 x 2	115	117	60.6	148	57.5

Material cards for spot weld beams and solids

■ Bolt grades with yield and tensile strength

Compatible Nut	Mild Steel	Grade 5	Grade 8	-	304	316
Common METRIC Steel Bolts						
Identification Mark						
Product Specification	Class 4.6	Class 5.8	Class 8.8	Class 10.9	Class 12.9 Socket Head Cap Screws	
Material	Low/Medium Carbon Steel	Low/Medium Carbon Steel Heat Treated	Medium Carbon Steel Heat Treated	Alloy Steel Heat Treated	Alloy Steel Heat Treated	
Tensile Strength Minimum	400 MPa (58000 psi)	520 MPa (75000 psi)	830 MPa (120000 psi)	1040 MPa (150000 psi)	1220 MPa (176000 psi)	
Yield Strength Minimum	240 MPa	420 MPa	640 MPa	940 MPa	1100 MPa	
Proof Load	220 MPa	380 MPa	600 MPa	830 MPa	970 MPa	
Hardness	Min HRB-67 Max HRB-95	Min HRB-82 Max HRB-95	Min HRC-22 Max HRC-34	Min HRC-32 Max HRC-39	Min HRC-39 Max HRC-44	
Compatible Nut	Class 5	Class 5	Class 8	Class 10	-	
* Approximate Equivalent INCH / METRIC Bolts						

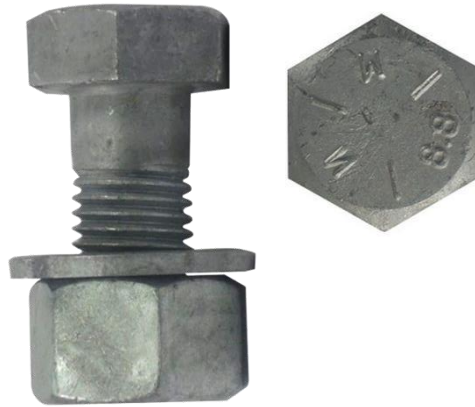

■ Material cards in [kg / mm / ms / kN / Gpa]

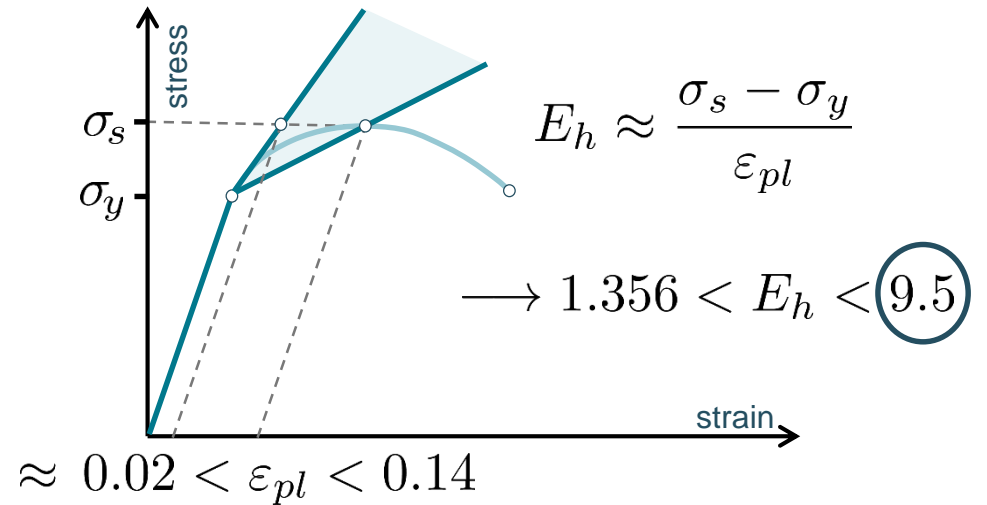

```

*MAT_SPOTWELD
$#      mid      ro      e      pr      sigy      eh      dt      tfail
      100      7.85e-6      210.0      0.3      0.64      9.5
$#      efail      nrr      nrs      nrt      mrr      mss      mtt      nf
    
```

```

*MAT_PLASTIC_KINEMATIC
$#      mid      ro      e      pr      sigy      etan      beta
      100      7.85e-6      210.0      0.3      0.64      9.5
$#      src      srp      fs      vp
                                   1.0
    
```

[images: www.FastenerBlackBook.com]

How to start the examples

■ Parameters to be altered by the user

```
-----  
$  
$ Run file as is. It was tested with LS-DYNA R9.2 with double precision.  
$  
-----  
$# Units: kg / mm / ms / kN / GPa / kN-mm  
-----  
$  
*KEYWORD  
*PARAMETER  
$# prmr1 val1 prmr2 val2 prmr3 val3 prmr4 val4  
$  
$--- Simulation time  
R tEnd 5.0  
$  
$--- Pre-force in beams / Pre-stress in solids (cross sect 74.9859 mm^2)  
R bltForce 28.8  
R bltStrss 0.3841  
$  
$--- Loading of the connection  
R distX 5.0  
R distY 0.0  
$  
$=====  
$ INCLUDE cards  
$=====  
$  
*INCLUDE  
control_explicit.k  
$control_implicit.k  
$  
*INCLUDE  
$bolted_connection_a.k  
$bolted_connection_b.k  
bolted_connection_c.k  
$bolted_connection_d.k
```

set termination time

define pre-tension

define displacement

select if explicit or implicit

select bolt model

■ Parameters that are automatically computed

```
*PARAMETER_EXPRESSION  
$# prmr1 expression1  
$  
$--- Plot intervals  
R dtPlot TEnd/50.0  
R dtAscii TEnd/1000.0  
$  
$--- Load application times  
R dtPreStr TEnd/5.0  
R tLoad TEnd/2.0  
$  
$--- Implicit time integration  
R dt0 dtPreStr/20.  
R dtMin dtPreStr/30.  
R dtMax dtPreStr/10.  
R tDyDth dtPreStr*2./3.  
R tDyBur dtPreStr  
R tDyBir tLoad  
$  
$--- Infinity time  
R tInfty tEnd*1.01
```

automatic plot intervals

load application based on termination time

implicit parameters based on termination time

numerical infinity

Deformation behavior with explicit simulations

- Similar deformation behavior for all bolt types
- Implicit simulations show less vibrations

type a)

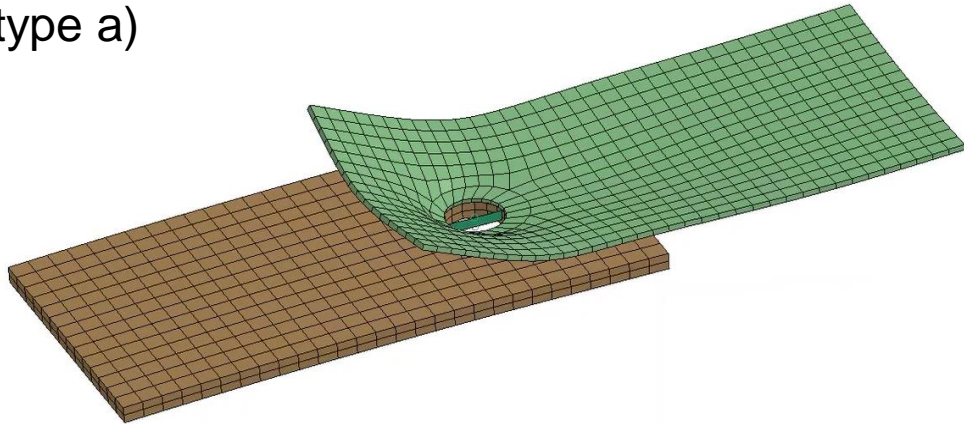

type b)

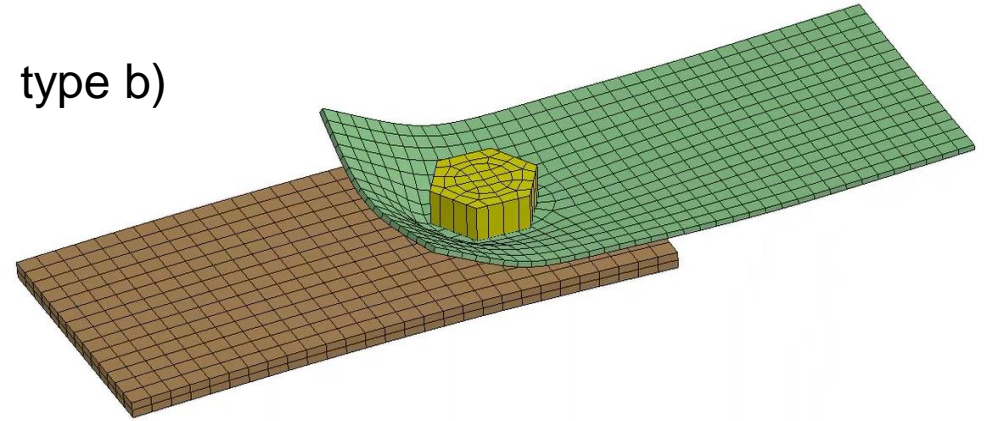

type c)

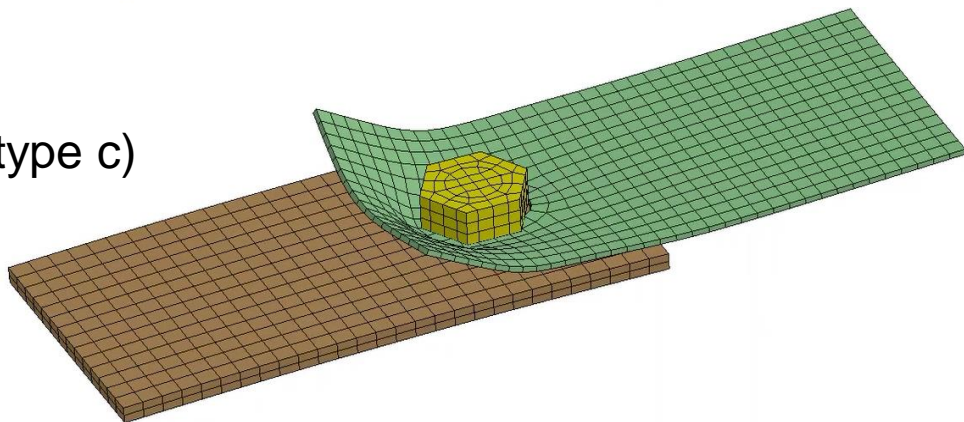

type d)

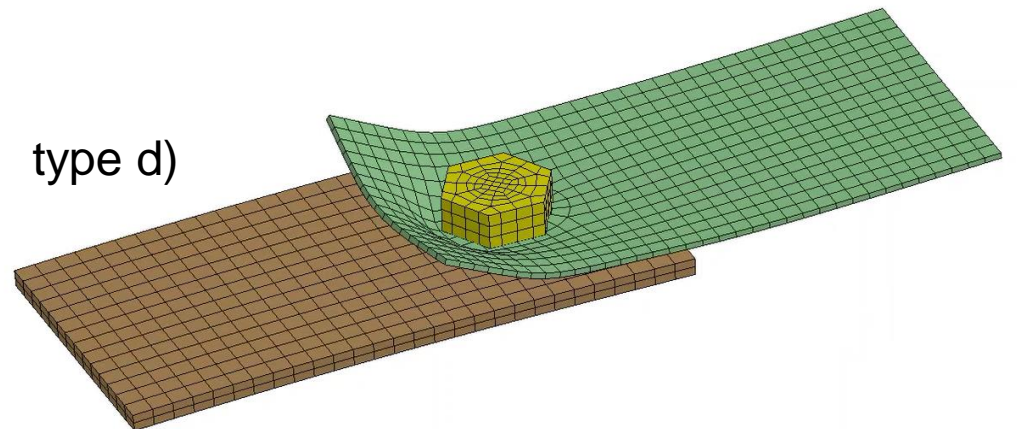

Von-Mises stress with implicit simulations

- Bolt type a) shows no slip and thus no hole bearing

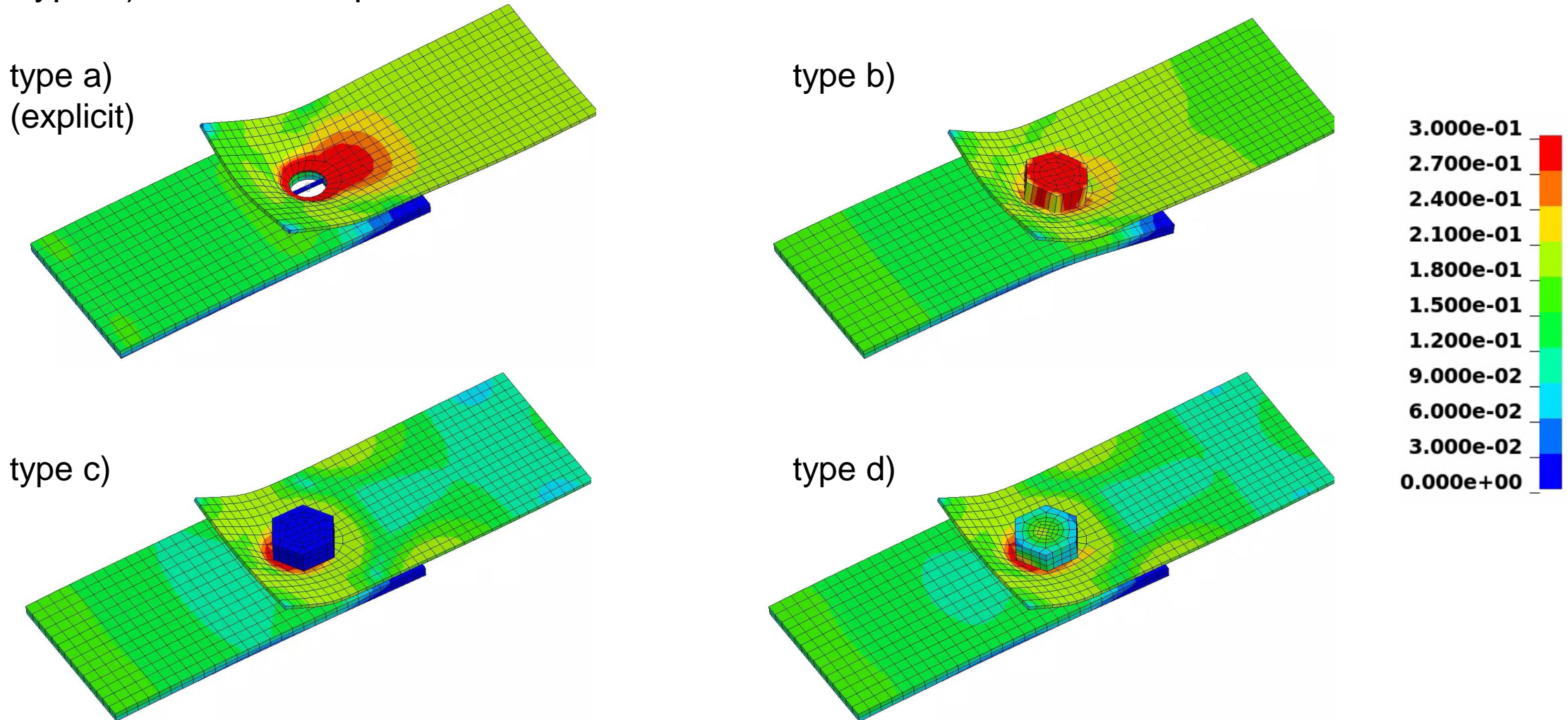

Plastic strains with explicit simulations

- Bolt type a) shows no slip and thus no hole bearing

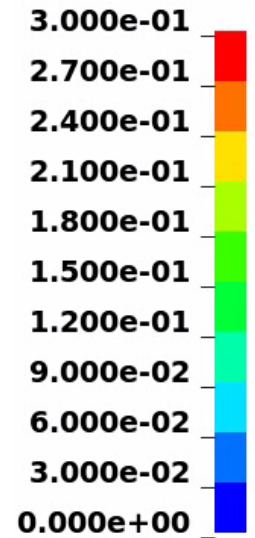
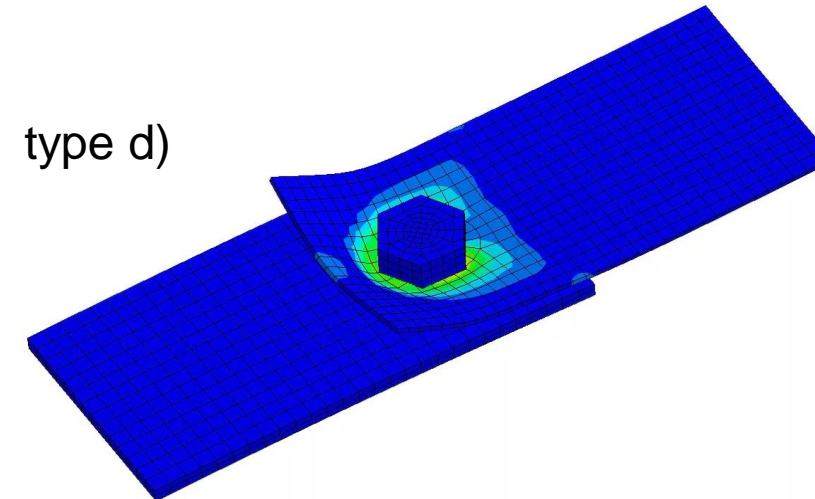
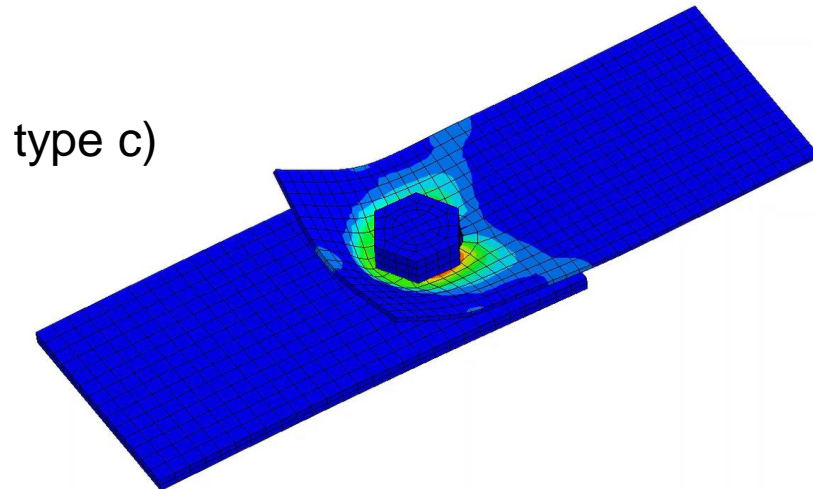
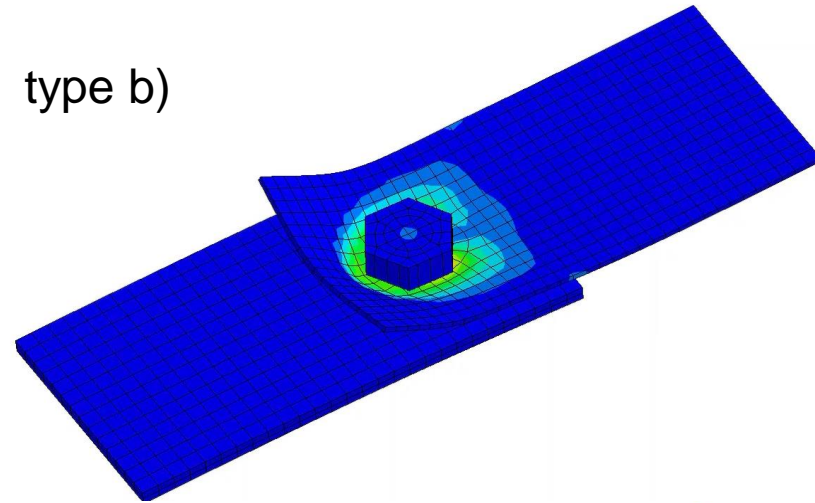
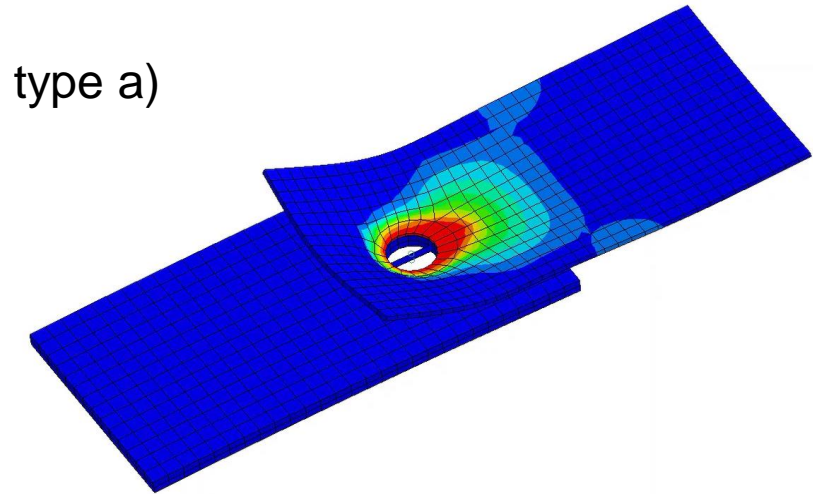

Force displacement curves and bolt forces

- All bolt types play initially in the same ball park
- Implicit sometimes behaves different than explicit
 - Different contact treatment, also in terms of stiffness and thickness
 - Might need further investigation

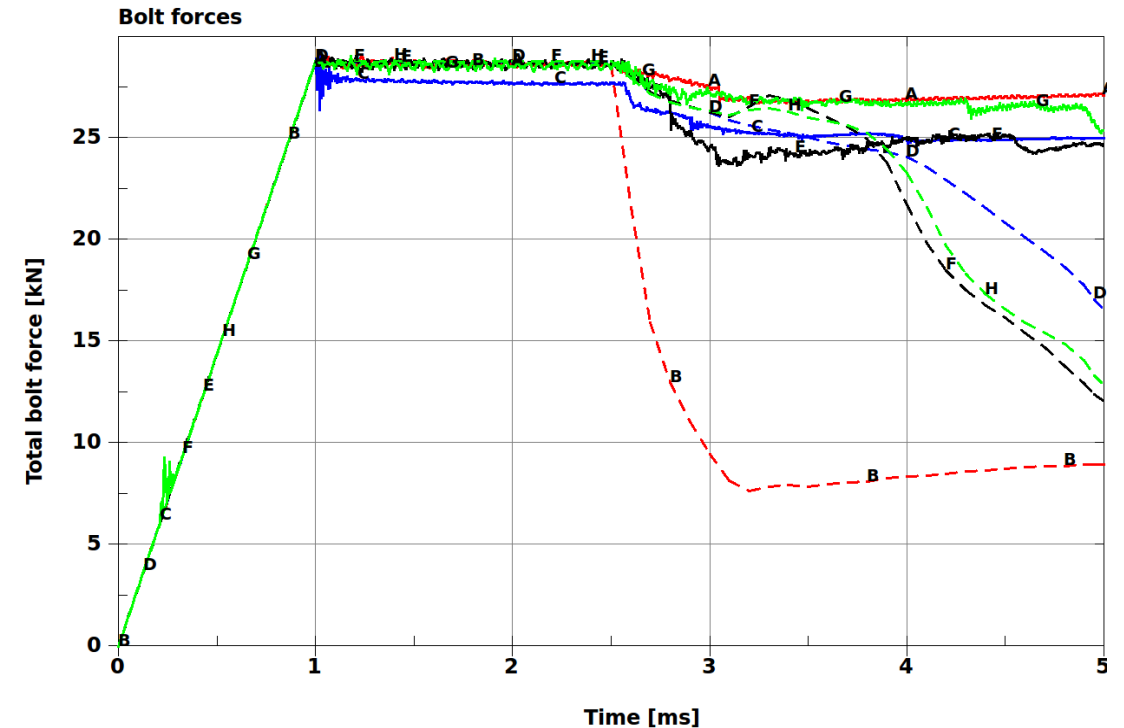
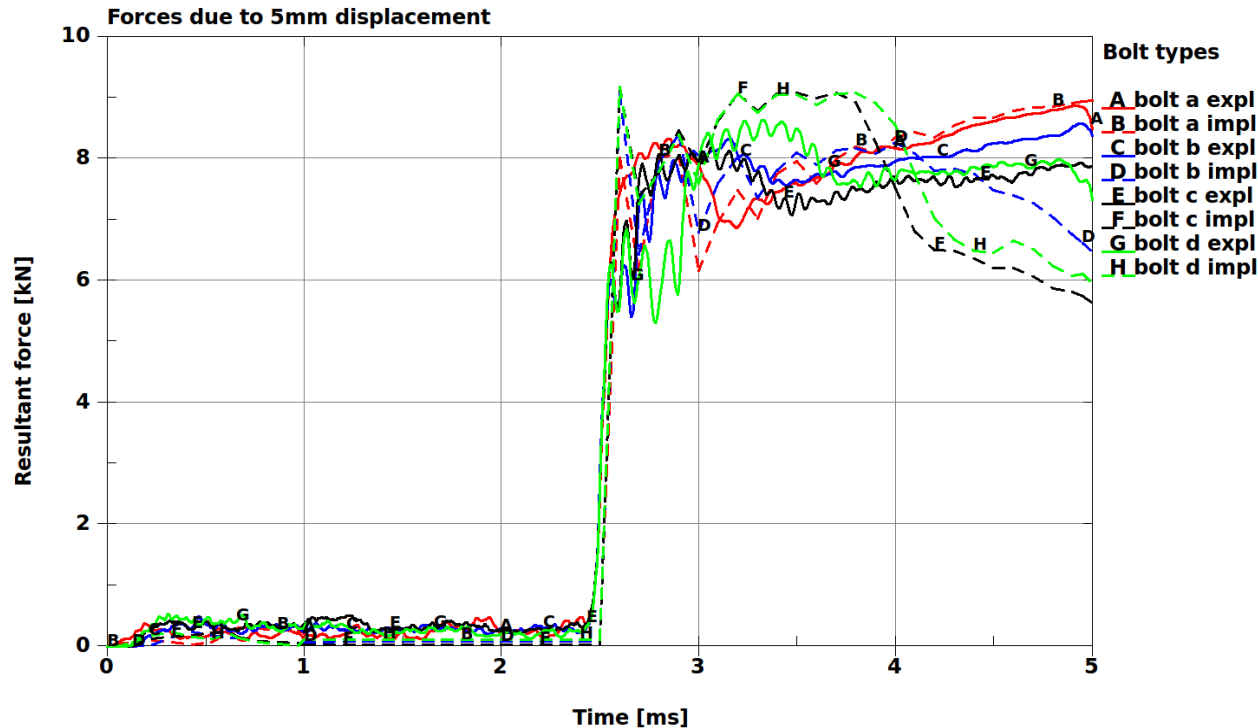

Conclusions

- Many possibilities to model bolts in LS-DYNA
- Many things to keep in mind
 - Keep parts as close together as possible before pre-tensioning
 - Provide reasonable time for pre-tension (≥ 1 ms)
 - Account for extra space in the bolt hole when using contact null beams
 - When using solid elements in the shaft
 - Try to avoid pentahedrons in the shaft
 - Use new `izshear` option in `*INITIAL_STRESS_SECTION`
- Explicit as well implicit works fine
 - Implicit time step independent of element size
 - Might be beneficial for longer time spans
 - Attention is needed when comparing results

Thank you
for your attention!

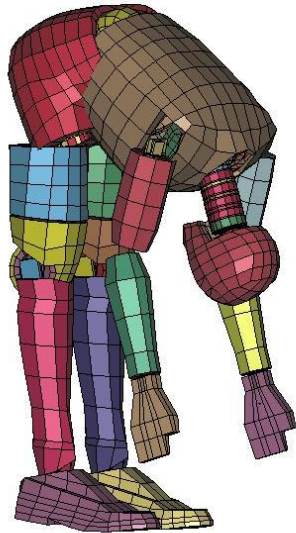

DYNA
MORE

Your LS-DYNA distributor and more



LSTC
Livermore Software
Technology Corp.

Multipurpose simulation tools