

**LS-DYNA<sup>®</sup>**  
**KEYWORD USER'S MANUAL**  
**VOLUME I**

**February 2012**  
**Version 971 R6.0.0**

**LIVERMORE SOFTWARE TECHNOLOGY CORPORATION (LSTC)**

## Corporate Address

Livermore Software Technology Corporation  
P. O. Box 712  
Livermore, California 94551-0712

## Support Addresses

Livermore Software Technology Corporation  
7374 Las Positas Road  
Livermore, California 94551  
Tel: 925-449-2500 ♦ Fax: 925-449-2507

**Email:** [sales@lstc.com](mailto:sales@lstc.com)

**Website:** [www.lstc.com](http://www.lstc.com)

Livermore Software Technology Corporation  
1740 West Big Beaver Road  
Suite 100  
Troy, Michigan 48084  
Tel: 248-649-4728 ♦ Fax: 248-649-6328

## Disclaimer

Copyright © 1992-2012 Livermore Software Technology Corporation. All Rights Reserved.

LS-DYNA<sup>®</sup>, LS-OPT<sup>®</sup> and LS-PrePost<sup>®</sup> are registered trademarks of Livermore Software Technology Corporation in the United States. All other trademarks, product names and brand names belong to their respective owners.

LSTC products are protected under the following US patents: 7953578, 7945432, 7702494, 7702490, 7664623, 7660480, 7657394, 7640146, 7613585, 7590514, 7533577, 7516053, 7499050, 7472602, 7428713, 7415400, 7395128, 7392163, 7386428, 7386425, 7382367, 7308387, 7286972, 7167816, 8050897, 8069017, 7987143, 7996344, and pending patents applications.

LSTC reserves the right to modify the material contained within this manual without prior notice.

The information and examples included herein are for illustrative purposes only and are not intended to be exhaustive or all-inclusive. LSTC assumes no liability or responsibility whatsoever for any direct or indirect damages or inaccuracies of any type or nature that could be deemed to have resulted from the use of this manual.

Any reproduction, in whole or in part, of this manual is prohibited without the prior written approval of LSTC. All requests to reproduce the contents hereof should be sent to [sales@lstc.com](mailto:sales@lstc.com).

---

AES

Copyright © 2001, Dr Brian Gladman <[brg@gladman.uk.net](mailto:brg@gladman.uk.net)>, Worcester, UK. All rights reserved.

## LICENSE TERMS

The free distribution and use of this software in both source and binary form is allowed (with or without changes) provided that:

1. distributions of this source code include the above copyright notice, this list of conditions and the following disclaimer;
2. distributions in binary form include the above copyright notice, this list of conditions and the following disclaimer in the documentation and/or other associated materials;
3. the copyright holder's name is not used to endorse products built using this software without specific written permission.

## DISCLAIMER

This software is provided 'as is' with no explicit or implied warranties in respect of any properties, including, but not limited to, correctness and fitness for purpose.

---

Issue Date: 21/01/2002

This file contains the code for implementing the key schedule for AES (Rijndael) for block and key sizes of 16, 24, and 32 bytes.

# TABLE OF CONTENTS

---

## TABLE OF CONTENTS

TABLE OF CONTENTS .....	0-1
INTRODUCTION .....	1-1
<b>CHRONOLOGICAL HISTORY</b> .....	1-1
<b>MATERIAL MODELS</b> .....	1-1
<b>SPATIAL DISCRETIZATION</b> .....	1-2
<b>CONTACT-IMPACT INTERFACES</b> .....	1-4
<b>MODEL SIZING</b> .....	1-6
<b>PRECISION</b> .....	1-7
GETTING STARTED.....	2-1
<b>DESCRIPTION OF KEYWORD INPUT</b> .....	2-1
<b>EXECUTION SYNTAX</b> .....	2-11
<b>SENSE SWITCH CONTROLS</b> .....	2-13
<b>RESTART ANALYSIS</b> .....	2-17
<b>VDA/IGES DATABASES</b> .....	2-18
<b>LS-PREPOST®</b> .....	2-19
<b>UNITS</b> .....	2-22
<b>GENERAL CARD FORMAT</b> .....	2-22
* <b>AIRBAG</b> .....	3-1
* <b>AIRBAG_OPTION1_{OPTION2}_{OPTION3}_{OPTION4}</b> .....	3-2
<b>SIMPLE_PRESSURE_VOLUME</b> OPTION:.....	3-9
<b>SIMPLE_AIRBAG_MODEL</b> OPTION:.....	3-11
<b>ADIABATIC_GAS_MODEL</b> OPTION:.....	3-14
<b>WANG_NEFSKE</b> OPTIONS:.....	3-16
<b>LOAD_CURVE</b> OPTION: .....	3-32
<b>LINEAR_FLUID</b> OPTION:.....	3-33
<b>HYBRID AND HYBRID_JETTING</b> OPTIONS:.....	3-35
<b>HYBRID_CHEMKIN</b> OPTION:.....	3-43
* <b>AIRBAG_ADVANCED_ALE</b> .....	3-48
* <b>AIRBAG_ALE</b> .....	3-56
* <b>AIRBAG_INTERACTION</b> .....	3-70
* <b>AIRBAG_PARTICLE</b> .....	3-72
* <b>AIRBAG_REFERENCE_GEOMETRY_{OPTION}_{OPTION}</b> .....	3-81
* <b>AIRBAG_SHELL_REFERENCE_GEOMETRY</b> .....	3-83

# TABLE OF CONTENTS

---

<b>*ALE</b> .....	<b>4-1</b>
*ALE_AMBIENT_HYDROSTATIC .....	4-3
*ALE_FAIL_SWITCH_MMG_{OPTION} .....	4-6
*ALE_FSI_PROJECTION.....	4-8
*ALE_FRAGMENTATION.....	4-11
*ALE_FSI_SWITCH_MMG_{OPTION}.....	4-13
*ALE_MULTI-MATERIAL_GROUP .....	4-18
*ALE_REFERENCE_SYSTEM_CURVE.....	4-22
*ALE_REFERENCE_SYSTEM_GROUP.....	4-24
*ALE_REFERENCE_SYSTEM_NODE .....	4-31
*ALE_REFERENCE_SYSTEM_SWITCH.....	4-34
*ALE_REFINE.....	4-36
*ALE_SMOOTHING .....	4-39
*ALE_TANK_TEST .....	4-41
*ALE_UP_SWITCH .....	4-45
<b>*BOUNDARY</b> .....	<b>5-1</b>
*BOUNDARY_ACOUSTIC_COUPLING.....	5-3
*BOUNDARY_ALE_MAPPING.....	5-4
*BOUNDARY_AMBIENT_EOS.....	5-9
*BOUNDARY_CONVECTION_OPTION.....	5-11
*BOUNDARY_COUPLED.....	5-13
*BOUNDARY_CYCLIC_{OPTION} .....	5-15
*BOUNDARY_FLUX_OPTION.....	5-18
*BOUNDARY_MCOL.....	5-22
*BOUNDARY_NON_REFLECTING.....	5-24
*BOUNDARY_NON_REFLECTING_2D.....	5-26
*BOUNDARY_PAP .....	5-28
*BOUNDARY_PORE_FLUID_OPTION.....	5-30
*BOUNDARY_PRECRACK .....	5-32
*BOUNDARY_PRESCRIBED_ACCELEROMETER_RIGID .....	5-33
*BOUNDARY_PRESCRIBED_FINAL_GEOMETRY .....	5-35
*BOUNDARY_PRESCRIBED_MOTION_OPTION1_{OPTION2}.....	5-37
*BOUNDARY_PRESCRIBED_ORIENTATION_RIGID_OPTION .....	5-43
*BOUNDARY_PRESSURE_OUTFLOW_OPTION.....	5-48
*BOUNDARY_PWP_OPTION.....	5-49
*BOUNDARY_RADIATION_OPTION1_{OPTION2} .....	5-52



# TABLE OF CONTENTS

---

*BOUNDARY_RADIATION_SEGMENT.....	5-53
*BOUNDARY_RADIATION_SEGMENT_VF_OPTION.....	5-54
*BOUNDARY_RADIATION_SET.....	5-55
*BOUNDARY_SLIDING_PLANE.....	5-60
*BOUNDARY_SPC_OPTION1_{OPTION2}_{OPTION3}.....	5-61
*BOUNDARY_SPH_FLOW.....	5-64
*BOUNDARY_SPH_SYMMETRY_PLANE.....	5-67
*BOUNDARY_SYMMETRY_FAILURE.....	5-68
*BOUNDARY_TEMPERATURE_OPTION.....	5-69
*BOUNDARY_THERMAL_WELD.....	5-70
*BOUNDARY_USA_SURFACE.....	5-73
<b>*BOUNDARY_ELEMENT_METHOD_OPTION.....</b>	<b>6-1</b>
*BOUNDARY_ELEMENT_METHOD_CONTROL.....	6-2
*BOUNDARY_ELEMENT_METHOD_FLOW.....	6-4
*BOUNDARY_ELEMENT_METHOD_NEIGHBOR.....	6-6
*BOUNDARY_ELEMENT_METHOD_SYMMETRY.....	6-10
*BOUNDARY_ELEMENT_METHOD_WAKE.....	6-11
<b>*CASE.....</b>	<b>7-1</b>
<b>*COMMENT.....</b>	<b>7-1</b>
<b>*COMPONENT.....</b>	<b>8-1</b>
*COMPONENT_GEBOD_OPTION.....	8-2
*COMPONENT_GEBOD_JOINT_OPTION.....	8-4
*COMPONENT_HYBRIDIII.....	8-8
*COMPONENT_HYBRIDIII_JOINT_OPTION.....	8-10
<b>*CONSTRAINED.....</b>	<b>9-1</b>
*CONSTRAINED_ADAPTIVITY.....	9-2
*CONSTRAINED_BUTT_WELD.....	9-3
*CONSTRAINED_COORDINATE_{OPTION}.....	9-6
*CONSTRAINED_EULER_IN_EULER.....	9-9
*CONSTRAINED_EXTRA_NODES_OPTION.....	9-11
*CONSTRAINED_GENERALIZED_WELD_OPTION_{OPTION}.....	9-13
*CONSTRAINED_GLOBAL.....	9-26
*CONSTRAINED_INTERPOLATION_{OPTION}.....	9-28
*CONSTRAINED_INTERPOLATION_SPOTWELD.....	9-33
*CONSTRAINED_JOINT_OPTION_{OPTION}_{OPTION}_{OPTION}.....	9-37

# TABLE OF CONTENTS

---

*CONSTRAINED_JOINT_COOR_OPTION_{OPTION}_{OPTION}_{OPTION} .....	9-49
*CONSTRAINED_JOINT_STIFFNESS_OPTION_{OPTION} .....	9-56
*CONSTRAINED_JOINT_USER_FORCE .....	9-70
*CONSTRAINED_LAGRANGE_IN_SOLID_{OPTION1}_{OPTION2} .....	9-71
*CONSTRAINED_LINEAR_GLOBAL .....	9-89
*CONSTRAINED_LINEAR_LOCAL .....	9-92
*CONSTRAINED_LOCAL .....	9-95
*CONSTRAINED_NODAL_RIGID_BODY_{OPTION}_{OPTION}_{OPTION} .....	9-97
*CONSTRAINED_NODE_INTERPOLATION .....	9-106
*CONSTRAINED_NODE_SET_{OPTION} .....	9-108
*CONSTRAINED_POINTS .....	9-111
*CONSTRAINED_RIGID_BODIES .....	9-113
*CONSTRAINED_RIGID_BODY_STOPPERS .....	9-115
*CONSTRAINED_RIVET_{OPTION} .....	9-118
*CONSTRAINED_SHELL_TO_SOLID .....	9-120
*CONSTRAINED_SPLINE .....	9-123
*CONSTRAINED_SPR2 .....	9-125
*CONSTRAINED_SPOTWELD_{OPTION}_{OPTION} .....	9-130
*CONSTRAINED_TIE-BREAK .....	9-134
*CONSTRAINED_TIED_NODES_FAILURE .....	9-135
<b>*CONTACT .....</b>	<b>10-1</b>
*CONTACT_OPTION1_{OPTION2}_{OPTION3}_{OPTION4}_{OPTION5}_{OPTION6} ..	10-2
<b>CARD 1</b> .....	10-10
<b>CARD 2</b> .....	10-12
<b>CARD 3</b> .....	10-15
<b>CARD 4</b> .....	10-17
*CONTACT_..._THERMAL_FRICTION_... .....	10-36
*CONTACT_..._ORTHO_FRICTION_... .....	10-39
<b>OPTIONAL CARD A</b> .....	10-41
<b>OPTIONAL CARD B</b> .....	10-44
<b>OPTIONAL CARD C</b> .....	10-46
<b>OPTIONAL CARD D</b> .....	10-49
<b>OPTIONAL CARD E</b> .....	10-51
<b>GENERAL REMARKS ON *CONTACT:</b> .....	10-52
*CONTACT_AUTO_MOVE .....	10-62
*CONTACT_COUPLING .....	10-66

# TABLE OF CONTENTS

---

*CONTACT_ENTITY .....	10-68
*CONTACT_GEBOD_OPTION.....	10-76
*CONTACT_GUIDED_CABLE_{OPTION1}_{OPTION2}.....	10-79
*CONTACT_INTERIOR.....	10-81
*CONTACT_RIGID_SURFACE.....	10-83
*CONTACT_1D.....	10-87
*CONTACT_2D_OPTION1_{OPTION2}_{OPTION3}.....	10-89
*CONTACT_2D_AUTOMATIC OPTIONS:.....	10-93
*CONTACT_2D_NODE_TO_SOLID OPTIONS:.....	10-98
REMARKS:.....	10-99
<b>*CONTROL.....</b>	<b>11-1</b>
*CONTROL_ACCURACY.....	11-4
*CONTROL_ADAPSTEP.....	11-6
*CONTROL_ADAPTIVE.....	11-7
*CONTROL_ADAPTIVE_CURVE.....	11-15
*CONTROL_ADAPTIVE_SOLID_TO_SPH.....	11-17
*CONTROL_ALE.....	11-18
*CONTROL_BULK_VISCOSITY.....	11-23
*CONTROL_CHECK_{OPTION}.....	11-25
*CONTROL_COARSEN.....	11-27
*CONTROL_CONTACT.....	11-29
*CONTROL_COUPLING.....	11-39
*CONTROL_CPU.....	11-41
*CONTROL_CPM.....	11-42
*CONTROL_DISCRETE_ELEMENT.....	11-43
*CONTROL_DYNAMIC_RELAXATION.....	11-44
*CONTROL_EFG.....	11-48
*CONTROL_ENERGY.....	11-50
*CONTROL_EXPLOSIVE_SHADOW.....	11-51
*CONTROL_FORMING_AUTO_NET.....	11-52
*CONTROL_FORMING_AUTOPOSITION_PARAMETER_{OPTION}.....	11-56
*CONTROL_FORMING_ONESTEP_OPTION.....	11-61
*CONTROL_FORMING_PARAMETER_READ.....	11-68
*CONTROL_FORMING_POSITION.....	11-71
*CONTROL_FORMING_PRE_BENDING.....	11-72
*CONTROL_FORMING_PROJECTION.....	11-75

# TABLE OF CONTENTS

---

*CONTROL_FORMING_SCRAP_FALL .....	11-76
*CONTROL_FORMING_STONING.....	11-81
*CONTROL_FORMING_TEMPLATE.....	11-87
*CONTROL_FORMING_TIPPING.....	11-93
*CONTROL_FORMING_TRAVEL.....	11-96
*CONTROL_FORMING_USER.....	11-97
*CONTROL_HOURLASS_{OPTION}.....	11-100
*CONTROL_IMPLICIT_AUTO .....	11-103
*CONTROL_IMPLICIT_BUCKLE.....	11-108
*CONTROL_IMPLICIT_CONSISTENT_MASS .....	11-109
*CONTROL_IMPLICIT_DYNAMICS .....	11-110
*CONTROL_IMPLICIT_EIGENVALUE .....	11-113
*CONTROL_IMPLICIT_FORMING .....	11-117
*CONTROL_IMPLICIT_GENERAL .....	11-126
*CONTROL_IMPLICIT_INERTIA_RELIEF .....	11-130
*CONTROL_IMPLICIT_JOINTS.....	11-131
*CONTROL_IMPLICIT_MODES_{OPTION} .....	11-132
*CONTROL_IMPLICIT_SOLUTION.....	11-135
*CONTROL_IMPLICIT_SOLVER.....	11-143
*CONTROL_IMPLICIT_STABILIZATION .....	11-147
*CONTROL_IMPLICIT_STATIC_CONDENSATION_{OPTION}.....	11-149
*CONTROL_IMPLICIT_TERMINATION.....	11-152
*CONTROL_MPP_CONTACT_GROUPABLE .....	11-154
*CONTROL_MPP_DECOMPOSITION_ARRANGE_PARTS.....	11-155
*CONTROL_MPP_DECOMPOSITION_AUTOMATIC .....	11-156
*CONTROL_MPP_DECOMPOSITION_BAGREF .....	11-157
*CONTROL_MPP_DECOMPOSITION_CHECK_SPEED .....	11-158
*CONTROL_MPP_DECOMPOSITION_CONTACT_DISTRIBUTE .....	11-159
*CONTROL_MPP_DECOMPOSITION_CONTACT_ISOLATE .....	11-160
*CONTROL_MPP_DECOMPOSITION_DISTRIBUTE_ALE_ELEMENTS.....	11-161
*CONTROL_MPP_DECOMPOSITION_DISTRIBUTE_SPH_ELEMENTS .....	11-162
*CONTROL_MPP_DECOMPOSITION_ELCOST .....	11-163
*CONTROL_MPP_DECOMPOSITION_FILE .....	11-164
*CONTROL_MPP_DECOMPOSITION_METHOD .....	11-165
*CONTROL_MPP_DECOMPOSITION_NUMPROC.....	11-166
*CONTROL_MPP_DECOMPOSITION_OUTDECOMP .....	11-167

# TABLE OF CONTENTS

---

*CONTROL_MPP_DECOMPOSITION_RCBLOG .....	11-168
*CONTROL_MPP_DECOMPOSITION_PARTS_DISTRIBUTE.....	11-169
*CONTROL_MPP_DECOMPOSITION_PARTSET_DISTRIBUTE.....	11-170
*CONTROL_MPP_DECOMPOSITION_RCBLOG .....	11-171
*CONTROL_MPP_DECOMPOSITION_SCALE_CONTACT_COST .....	11-172
*CONTROL_MPP_DECOMPOSITION_SCALE_FACTOR_SPH.....	11-173
*CONTROL_MPP_DECOMPOSITION_SHOW .....	11-174
*CONTROL_MPP_DECOMPOSITION_TRANSFORMATION.....	11-175
*CONTROL_MPP_IO_LSTC_REDUCE .....	11-177
*CONTROL_MPP_IO_NOBEAMOUT .....	11-178
*CONTROL_MPP_IO_NOD3DUMP.....	11-179
*CONTROL_MPP_IO_NODUMP .....	11-180
*CONTROL_MPP_IO_NOFAIL.....	11-181
*CONTROL_MPP_IO_NOFULL.....	11-182
*CONTROL_MPP_IO_SWAPBYTES.....	11-183
*CONTROL_NONLOCAL.....	11-184
*CONTROL_OUTPUT .....	11-185
*CONTROL_PARALLEL .....	11-189
*CONTROL_PORE_FLUID .....	11-191
*CONTROL_PORE_AIR .....	11-197
*CONTROL_REMESHING.....	11-198
*CONTROL_RIGID.....	11-199
*CONTROL_SHELL .....	11-201
*CONTROL_SOLID .....	11-210
*CONTROL_SOLUTION.....	11-212
*CONTROL_SPH.....	11-213
*CONTROL_SPOTWELD_BEAM .....	11-216
*CONTROL_START .....	11-220
*CONTROL_STAGED_CONSTRUCTION.....	11-221
*CONTROL_STEADY_STATE_ROLLING.....	11-224
*CONTROL_STRUCTURED_{OPTION} .....	11-226
*CONTROL_SUBCYCLE.....	11-227
*CONTROL_TERMINATION .....	11-228
*CONTROL_THERMAL_NONLINEAR.....	11-230
*CONTROL_THERMAL_SOLVER.....	11-231
*CONTROL_THERMAL_TIMESTEP .....	11-235

# TABLE OF CONTENTS

---

*CONTROL_TIMESTEP .....	11-236
*CONTROL_UNITS.....	11-241
<b>*DAMPING.....</b>	<b>11-1</b>
*DAMPING_FREQUENCY_RANGE.....	11-2
*DAMPING_GLOBAL .....	11-4
*DAMPING_PART_MASS_{OPTION}.....	11-6
*DAMPING_PART_STIFFNESS_{OPTION}.....	11-8
*DAMPING_RELATIVE.....	11-10
<b>*DATABASE .....</b>	<b>12-1</b>
*DATABASE_OPTION.....	12-2
*DATABASE_RCFORC_MOMENT.....	12-9
*DATABASE_ADAMS.....	12-10
*DATABASE_BINARY_OPTION .....	12-12
*DATABASE_CPM_SENSOR .....	12-17
*DATABASE_CROSS_SECTION_OPTION1_{OPTION2}.....	12-20
*DATABASE_EXTENT_OPTION.....	12-24
AVS, MPGS, AND MOVIE OPTIONS:.....	12-24
BINARY OPTION: .....	12-28
D3PART OPTION: .....	12-33
INTFOR OPTION: .....	12-36
SSSTAT OPTION: .....	12-37
REMARKS:.....	12-37
*DATABASE_FORMAT.....	12-40
*DATABASE_FREQUENCY_BINARY_OPTION.....	12-41
*DATABASE_FSI.....	12-44
*DATABASE_FSI_SENSOR.....	12-48
*DATABASE_HISTORY_OPTION.....	12-50
*DATABASE_MASSOUT.....	12-54
*DATABASE_NODAL_FORCE_GROUP.....	12-55
*DATABASE_PROFILE.....	12-56
*DATABASE_PWP_FLOW .....	12-58
*DATABASE_PWP_OUTPUT.....	12-59
*DATABASE_PAP_OUTPUT.....	12-60
*DATABASE_SPRING_FORWARD .....	12-61
*DATABASE_SUPERPLASTIC_FORMING .....	12-62
*DATABASE_TRACER .....	12-63

# TABLE OF CONTENTS

---

<b>*DEFINE</b> .....	<b>13-1</b>
*DEFINE_ADAPTIVE_SOLID_TO_SPH_{OPTION}.....	13-3
*DEFINE_ALEBAG_BAG.....	13-6
*DEFINE_ALEBAG_HOLE.....	13-11
*DEFINE_ALEBAG_INFLATOR.....	13-14
*DEFINE_BOX_{OPTION}.....	13-18
*DEFINE_BOX_ADAPTIVE_{OPTION}.....	13-21
*DEFINE_BOX_COARSEN_{OPTION}.....	13-24
*DEFINE_BOX_DRAWBEAD.....	13-27
*DEFINE_BOX_SPH_{OPTION}.....	13-29
*DEFINE_CONNECTION_PROPERTIES_{OPTION}.....	13-32
*DEFINE_CONSTRUCTION_STAGES.....	13-39
*DEFINE_CONTACT_VOLUME.....	13-40
*DEFINE_COORDINATE_NODES.....	13-43
*DEFINE_COORDINATE_SYSTEM_{OPTION}.....	13-45
*DEFINE_COORDINATE_VECTOR.....	13-49
*DEFINE_CPM_BAG_INTERACTION.....	13-51
*DEFINE_CPM_CHAMBER.....	13-52
*DEFINE_CPM_GAS_PROPERTIES.....	13-55
*DEFINE_CPM_VENT.....	13-57
*DEFINE_CURVE_{OPTION}.....	13-59
*DEFINE_CURVE_COMPENSATION.....	13-62
*DEFINE_CURVE_COMPENSATION_CONSTRAINT_{OPTION}.....	13-63
*DEFINE_CURVE_DRAWBEAD.....	13-68
*DEFINE_CURVE_DUPLICATE.....	13-71
*DEFINE_CURVE_ENTITY.....	13-72
*DEFINE_CURVE_FEEDBACK.....	13-74
*DEFINE_CURVE_FLC.....	13-77
*DEFINE_CURVE_FUNCTION.....	13-79
*DEFINE_CURVE_SMOOTH.....	13-92
*DEFINE_CURVE_TRIM_{OPTION}.....	13-94
*DEFINE_DEATH_TIMES_OPTION.....	13-105
*DEFINE_DE_ACTIVE_REGION.....	13-108
*DEFINE_DE_TO_SURFACE_COUPLING.....	13-109
*DEFINE_ELEMENT_DEATH_OPTION.....	13-110
*DEFINE_ELEMENT_GENERALIZED_SHELL.....	13-111

# TABLE OF CONTENTS

---

*DEFINE_ELEMENT_GENERALIZED_SOLID .....	13-115
*DEFINE_FILTER .....	13-118
*DEFINE_FORMING_BLANKMESH .....	13-120
*DEFINE_FRICTION .....	13-125
*DEFINE_FRICTION_ORIENTATION .....	13-127
*DEFINE_FUNCTION.....	13-131
*DEFINE_FUNCTION_TABULATED .....	13-132
*DEFINE_GROUND_MOTION .....	13-134
*DEFINE_HEX_SPOTWELD_ASSEMBLY_{OPTION} .....	13-135
*DEFINE_MULTI_DRAWBEADS_IGES .....	13-137
*DEFINE_SD_ORIENTATION .....	13-139
*DEFINE_SET_ADAPTIVE.....	13-141
*DEFINE_SPH_TO_SPH_COUPLING_{OPTION} .....	13-142
*DEFINE_SPOTWELD_FAILURE_RESULTANTS .....	13-144
*DEFINE_SPOTWELD_MULTISCALE.....	13-146
*DEFINE_SPOTWELD RUPTURE_PARAMETER.....	13-147
*DEFINE_SPOTWELD RUPTURE_STRESS .....	13-150
*DEFINE_STAGED_CONSTRUCTION_PART_{OPTION}.....	13-152
*DEFINE_TABLE .....	13-154
*DEFINE_TABLE_2D.....	13-156
*DEFINE_TABLE_3D.....	13-158
*DEFINE_TRACER_PARTICLES_2D.....	13-160
*DEFINE_TRANSFORMATION .....	13-161
*DEFINE_TRIM_SEED_POINT_COORDINATES.....	13-165
*DEFINE_VECTOR.....	13-167
EXAMPLES.....	13-168
<b>*DEFORMABLE_TO_RIGID .....</b>	<b>14-1</b>
*DEFORMABLE_TO_RIGID.....	14-2
*DEFORMABLE_TO_RIGID_AUTOMATIC.....	14-3
*DEFORMABLE_TO_RIGID_INERTIA.....	14-8
<b>*EF .....</b>	<b>15-1</b>
*EF_CONTROL.....	15-2
*EF_GRID .....	15-4
*EF_MATERIAL.....	15-5
*EF_TOGGLES .....	15-8



# TABLE OF CONTENTS

---

<b>*ELEMENT .....</b>	<b>16-1</b>
*ELEMENT_BLANKING .....	16-3
*ELEMENT_BEAM_{OPTION}_{OPTION} .....	16-4
*ELEMENT_BEAM_PULLEY .....	16-15
*ELEMENT_DIRECT_MATRIX_INPUT_{OPTION} .....	16-17
*ELEMENT_DISCRETE_{OPTION} .....	16-20
*ELEMENT_DISCRETE_SPHERE .....	16-23
*ELEMENT_GENERALIZED_SHELL .....	16-24
*ELEMENT_GENERALIZED_SOLID .....	16-27
*ELEMENT_INERTIA_{OPTION} .....	16-30
*ELEMENT_INTERPOLATION_SHELL .....	16-33
*ELEMENT_INTERPOLATION_SOLID .....	16-36
*ELEMENT_MASS_{OPTION} .....	16-39
*ELEMENT_MASS_MATRIX_{OPTION} .....	16-40
*ELEMENT_MASS_PART_{OPTION} .....	16-42
*ELEMENT_PLOTEL .....	16-43
*ELEMENT_SEATBELT .....	16-44
*ELEMENT_SEATBELT_ACCELEROMETER .....	16-46
*ELEMENT_SEATBELT_PRETENSIONER .....	16-48
*ELEMENT_SEATBELT_RETRACTOR .....	16-53
*ELEMENT_SEATBELT_SENSOR .....	16-59
*ELEMENT_SEATBELT_SLIPRING .....	16-63
*ELEMENT_SHELL_{OPTION} .....	16-69
*ELEMENT_SHELL_NURBS_PATCH .....	16-76
*ELEMENT_SHELL_SOURCE_SINK .....	16-82
*ELEMENT_SOLID_{OPTION} .....	16-83
*ELEMENT_SPH .....	16-89
*ELEMENT_TRIM .....	16-91
*ELEMENT_TSHELL .....	16-92
<b>*EOS .....</b>	<b>17-1</b>
*EOS_LINEAR_POLYNOMIAL .....	17-7
*EOS_JWL .....	17-9
*EOS_SACK_TUESDAY .....	17-10
*EOS_GRUNEISEN .....	17-11
*EOS_RATIO_OF_POLYNOMIALS .....	17-13
*EOS_LINEAR_POLYNOMIAL_WITH_ENERGY_LEAK .....	17-18

# TABLE OF CONTENTS

---

*EOS_IGNITION_AND_GROWTH_OF_REACTION_IN_HE .....	17-20
*EOS_TABULATED_COMPACTION .....	17-24
*EOS_TABULATED .....	17-26
*EOS_PROPELLANT_DEFLAGRATION .....	17-28
*EOS_TENSOR_PORE_COLLAPSE .....	17-33
*EOS_IDEAL_GAS .....	17-36
*EOS_JWLB.....	17-38
*EOS_GASKET .....	17-42
*EOS_MIE_GRUNEISEN .....	17-45
*EOS_USER_DEFINED .....	17-47
<b>*FREQUENCY_DOMAIN.....</b>	<b>18-1</b>
*FREQUENCY_DOMAIN_ACOUSTIC_BEM_{OPTION}.....	18-2
*FREQUENCY_DOMAIN_ACOUSTIC_FEM.....	18-10
*FREQUENCY_DOMAIN_FRF .....	18-15
*FREQUENCY_DOMAIN_RANDOM_VIBRATION.....	18-20
*FREQUENCY_DOMAIN_RESPONSE_SPECTRUM.....	18-28
*FREQUENCY_DOMAIN_SSD .....	18-32
<b>*HOURLASS .....</b>	<b>19-1</b>
<b>*INCLUDE.....</b>	<b>20-1</b>
*INCLUDE_{OPTION} .....	20-2
*INCLUDE_COMPENSATION_{OPTION}.....	20-12
*INCLUDE_MULTISCALE_SPOTWELD .....	20-19
*INCLUDE_TRIM.....	20-22
<b>*INITIAL .....</b>	<b>21-1</b>
*INITIAL_AIRBAG_PARTICLE_POSITION .....	21-3
*INITIAL_ALE_MAPPING .....	21-4
*INITIAL_AXIAL_FORCE_BEAM.....	21-7
*INITIAL_DETONATION .....	21-8
*INITIAL_FIELD_SOLID.....	21-11
*INITIAL_FOAM_REFERENCE_GEOMETRY .....	21-13
*INITIAL_GAS_MIXTURE.....	21-14
*INITIAL_HYDROSTATIC_ALE .....	21-16
*INITIAL_INTERNAL_DOF_SOLID_{OPTION}.....	21-19
*INITIAL_MOMENTUM.....	21-21
*INITIAL_PWP_DEPTH_{OPTION} .....	21-22

# TABLE OF CONTENTS

---

*INITIAL_STRAIN_SHELL_{OPTION}	21-23
*INITIAL_STRAIN_SOLID_{OPTION}	21-25
*INITIAL_STRAIN_TSHELL	21-26
*INITIAL_STRESS_BEAM	21-27
*INITIAL_STRESS_DEPTH_{OPTION}	21-29
*INITIAL_STRESS_SECTION	21-31
*INITIAL_STRESS_SHELL_{OPTION}	21-33
*INITIAL_STRESS_SOLID	21-38
*INITIAL_STRESS_SPH	21-42
*INITIAL_STRESS_TSHELL	21-43
*INITIAL_TEMPERATURE_OPTION	21-46
*INITIAL_VEHICLE_KINEMATICS	21-48
*INITIAL_VELOCITY	21-51
*INITIAL_VELOCITY_NODE	21-54
*INITIAL_VELOCITY_RIGID_BODY	21-55
*INITIAL_VELOCITY_GENERATION	21-56
*INITIAL_VELOCITY_GENERATION_START_TIME	21-59
*INITIAL_VOID_OPTION	21-60
*INITIAL_VOLUME_FRACTION	21-61
*INITIAL_VOLUME_FRACTION_GEOMETRY	21-62
<b>*INTEGRATION</b>	<b>22-1</b>
*INTEGRATION_BEAM	22-2
*INTEGRATION_SHELL	22-18
<b>*INTERFACE</b>	<b>23-1</b>
*INTERFACE_COMPENSATION_NEW_{OPTION}	23-3
*INTERFACE_COMPONENT_FILE	23-16
*INTERFACE_COMPONENT_OPTION1_{OPTION2}	23-18
*INTERFACE_LINKING_DISCRETE_NODE_OPTION	23-20
*INTERFACE_LINKING_EDGE	23-21
*INTERFACE_LINKING_FILE	23-22
*INTERFACE_LINKING_NODE_OPTION	23-23
*INTERFACE_LINKING_SEGMENT	23-24
*INTERFACE_SPRINGBACK_OPTION1_OPTION2	23-25
*INTERFACE_SSI_{OPTION}_ID	23-30
*INTERFACE_SSI_AUX_{OPTION}	23-34
*INTERFACE_SSI_AUX_EMBEDDED_{OPTION1}_{OPTION2}	23-35

# TABLE OF CONTENTS

---

*INTERFACE_SSI_STATIC_{OPTION}_ID.....	23-37
<b>*KEYWORD.....</b>	<b>24-1</b>
<b>*LOAD.....</b>	<b>25-1</b>
*LOAD_ALE_CONVECTION_{OPTION}.....	25-3
*LOAD_BEAM_OPTION.....	25-5
*LOAD_BLAST.....	25-7
*LOAD_BLAST_ENHANCED.....	25-10
*LOAD_BLAST_SEGMENT.....	25-15
*LOAD_BLAST_SEGMENT_SET.....	25-16
*LOAD_BODY_OPTION.....	25-17
*LOAD_BODY_GENERALIZED_OPTION.....	25-22
*LOAD_BODY_POROUS.....	25-25
*LOAD_BRODE.....	25-27
*LOAD_DENSITY_DEPTH.....	25-29
*LOAD_ERODING_PART_SET.....	25-31
*LOAD_GRAVITY_PART_{OPTION}.....	25-33
*LOAD_HEAT_CONTROLLER.....	25-35
*LOAD_HEAT_GENERATION_OPTION.....	25-36
*LOAD_MASK.....	25-38
*LOAD_MOTION_NODE.....	25-40
*LOAD_MOVING_PRESSURE.....	25-42
*LOAD_NODE_OPTION.....	25-44
*LOAD_REMOVE_PART_{OPTION}.....	25-47
*LOAD_RIGID_BODY.....	25-49
*LOAD_SEGMENT_{OPTION}.....	25-52
*LOAD_SEGMENT_NONUNIFORM_{OPTION}.....	25-56
*LOAD_SEGMENT_SET_{OPTION}.....	25-59
*LOAD_SEGMENT_SET_ANGLE.....	25-61
*LOAD_SEGMENT_SET_NONUNIFORM_{OPTION}.....	25-63
*LOAD_SEISMIC_SSI_OPTION1_{OPTION2}.....	25-65
*LOAD_SHELL_OPTION1_{OPTION2}.....	25-69
*LOAD_SPCFORC.....	25-72
*LOAD_SSA.....	25-73
*LOAD_STEADY_STATE_ROLLING.....	25-77
*LOAD_STIFFEN_PART_{OPTION}.....	25-81
*LOAD_SUPERPLASTIC_FORMING.....	25-83

# TABLE OF CONTENTS

---

*LOAD_SURFACE_STRESS_{OPTION} .....	25-89
*LOAD_THERMAL_OPTION .....	25-91
*LOAD_THERMAL_CONSTANT .....	25-92
*LOAD_THERMAL_CONSTANT_ELEMENT_OPTION .....	25-93
*LOAD_THERMAL_CONSTANT_NODE .....	25-94
*LOAD_THERMAL_LOAD_CURVE .....	25-95
*LOAD_THERMAL_TOPAZ .....	25-96
*LOAD_THERMAL_VARIABLE .....	25-97
*LOAD_THERMAL_VARIABLE_BEAM_{OPTION} .....	25-99
*LOAD_THERMAL_VARIABLE_ELEMENT_OPTION .....	25-101
*LOAD_THERMAL_VARIABLE_NODE .....	25-102
*LOAD_THERMAL_VARIABLE_SHELL_{OPTION} .....	25-103
*LOAD_VOLUME_LOSS .....	25-105
<b>*NODE .....</b>	<b>26-1</b>
*NODE_{OPTION} .....	26-2
*NODE_MERGE_SET .....	26-4
*NODE_MERGE_TOLERANCE .....	26-5
*NODE_RIGID_SURFACE .....	26-6
*NODE_SCALAR_{OPTION} .....	26-7
*NODE_TRANSFORM .....	26-8
<b>*PARAMETER .....</b>	<b>27-1</b>
*PARAMETER_{OPTION} .....	27-2
*PARAMETER_DUPLICATION .....	27-4
*PARAMETER_EXPRESSION_{OPTION} .....	27-5
<b>*PART .....</b>	<b>28-1</b>
*PART_{OPTION1}_{OPTION2}_{OPTION3}_{OPTION4}_{OPTION5} .....	28-2
*PART_ADAPTIVE_FAILURE .....	28-12
*PART_ANNEAL .....	28-13
*PART_COMPOSITE_{OPTION} .....	28-14
*PART_DUPLICATE .....	28-20
*PART_MODES .....	28-22
*PART_SENSOR .....	28-26
*PART_MOVE .....	28-27
<b>*PERTURBATION .....</b>	<b>29-1</b>
*PERTURBATION_OPTION .....	29-2

# TABLE OF CONTENTS

---

<b>*RAIL</b> .....	<b>30-1</b>
*RAIL_TRACK .....	30-2
*RAIL_TRAIN .....	30-7
<b>*RIGIDWALL</b> .....	<b>31-1</b>
* <b>RIGIDWALL_GEOMETRIC_OPTION_{OPTION}_{OPTION}}_{OPTION}</b> .....	31-2
* <b>RIGIDWALL_PLANAR_{OPTION}_{OPTION}_{OPTION}}</b> .....	31-11
<b>*SECTION</b> .....	<b>32-1</b>
*SECTION_ALE1D .....	32-2
*SECTION_ALE2D .....	32-4
*SECTION_BEAM_{OPTION} .....	32-5
*SECTION_BEAM_AISC .....	32-20
*SECTION_DISCRETE .....	32-22
*SECTION_POINT_SOURCE .....	32-25
*SECTION_POINT_SOURCE_MIXTURE .....	32-28
*SECTION_SEATBELT .....	32-34
*SECTION_SHELL_{OPTION} .....	32-35
*SECTION_SOLID_{OPTION} .....	32-50
*SECTION_SPH_{OPTION} .....	32-60
*SECTION_TSHELL .....	32-63
<b>*SENSOR</b> .....	<b>33-1</b>
*SENSOR_CONTROL .....	33-3
*SENSOR_DEFINE_CALC-MATH .....	33-5
*SENSOR_DEFINE_ELEMENT_{OPTION} .....	33-7
*SENSOR_DEFINE_FORCE .....	33-9
*SENSOR_DEFINE_NODE_{OPTION} .....	33-11
*SENSOR_SWITCH .....	33-13
*SENSOR_SWITCH_CALC-LOGIC .....	33-14
<b>*SET</b> .....	<b>34-1</b>
*SET_BEAM_{OPTION} .....	34-3
*SET_BEAM_ADD .....	34-6
*SET_BEAM_INTERSECT .....	34-7
*SET_DISCRETE_{OPTION} .....	34-8
*SET_DISCRETE_ADD .....	34-11
*SET_MULTI-MATERIAL_GROUP_LIST .....	34-12
*SET_NODE_{OPTION} .....	34-14

# TABLE OF CONTENTS

---

*SET_NODE_ADD_{OPTION} .....	34-18
*SET_NODE_INTERSECT .....	34-20
*SET_PART_{OPTION} .....	34-21
*SET_PART_ADD .....	34-24
*SET_SEGMENT_{OPTION} .....	34-25
*SET_SEGMENT_ADD .....	34-30
*SET_SEGMENT_INTERSECT .....	34-31
*SET_2D_SEGMENT_{OPTION} .....	34-32
*SET_SHELL_{OPTION} .....	34-34
*SET_SHELL_ADD .....	34-38
*SET_SHELL_INTERSECT .....	34-39
*SET_SOLID_{OPTION} .....	34-40
*SET_SOLID_ADD .....	34-43
*SET_SOLID_INTERSECT .....	34-44
*SET_TSHELL_{OPTION} .....	34-45
<b>*TERMINATION .....</b>	<b>35-1</b>
*TERMINATION_BODY .....	35-2
*TERMINATION_CONTACT .....	35-3
*TERMINATION_CURVE .....	35-4
*TERMINATION_DELETED_SHELLS_{OPTION} .....	35-5
*TERMINATION_DELETED_SOLIDS_{OPTION} .....	35-6
*TERMINATION_NODE .....	35-7
*TERMINATION_SENSOR .....	35-8
<b>*TITLE .....</b>	<b>36-1</b>
<b>*USER .....</b>	<b>37-1</b>
*USER_INTERFACE_OPTION .....	37-1
*USER_LOADING .....	37-3
*USER_LOADING_SET .....	37-4
<b>RESTART INPUT DATA .....</b>	<b>38-1</b>
*CHANGE_OPTION .....	38-3
*CONTROL_DYNAMIC_RELAXATION .....	38-14
*CONTROL_SHELL .....	38-16
*CONTROL_TERMINATION .....	38-18
*CONTROL_TIMESTEP .....	38-19
*DAMPING_GLOBAL .....	38-20

# TABLE OF CONTENTS

---

*DATABASE_OPTION.....	38-21
*DATABASE_BINARY_OPTION .....	38-23
*DELETE_OPTION .....	38-24
*INTERFACE_SPRINGBACK_LSDYNA .....	38-26
*RIGID_DEFORMABLE_OPTION .....	38-28
*RIGID_DEFORMABLE_CONTROL .....	38-29
*RIGID_DEFORMABLE_D2R.....	38-30
*RIGID_DEFORMABLE_R2D.....	38-31
*STRESS_INITIALIZATION_{OPTION} .....	38-32
*TERMINATION_OPTION .....	38-34
*TITLE.....	38-36
<b>REFERENCES .....</b>	<b>39-1</b>
<b>APPENDIX A: USER DEFINED MATERIALS.....</b>	<b>40-1</b>
<b>APPENDIX B: USER DEFINED EQUATION OF STATE .....</b>	<b>41-1</b>
<b>APPENDIX C: USER DEFINED ELEMENT INTERFACE FOR SOLIDS AND SHELLS.....</b>	<b>42-1</b>
<b>APPENDIX D: USER DEFINED AIRBAG SENSOR .....</b>	<b>43-1</b>
<b>APPENDIX E: USER DEFINED SOLUTION CONTROL .....</b>	<b>44-1</b>
<b>APPENDIX F: USER DEFINED INTERFACE CONTROL.....</b>	<b>45-1</b>
<b>APPENDIX G: USER DEFINED INTERFACE FRICTION AND CONDUCTIVITY .....</b>	<b>46-1</b>
<b>APPENDIX H: USER DEFINED THERMAL MATERIAL MODEL.....</b>	<b>47-1</b>
<b>APPENDIX I: OCCUPANT SIMULATION INCLUDING THE COUPLING TO PROGRAMS CAL3D AND MADYMO .....</b>	<b>48-1</b>
<b>INTRODUCTION .....</b>	<b>48-1</b>
<b>THE LS-DYNA/OCCUPANT SIMULATION PROGRAM LINK .....</b>	<b>48-1</b>
<b>DUMMY MODELING .....</b>	<b>48-3</b>
<b>AIRBAG MODELING .....</b>	<b>48-4</b>
<b>KNEE BOLSTER.....</b>	<b>48-5</b>
<b>COMMON ERRORS.....</b>	<b>48-5</b>
<b>APPENDIX J: INTERACTIVE GRAPHICS COMMANDS .....</b>	<b>49-1</b>
<b>APPENDIX K: INTERACTIVE MATERIAL MODEL DRIVER.....</b>	<b>50-1</b>
<b>INTRODUCTION .....</b>	<b>50-1</b>
<b>INPUT DEFINITION .....</b>	<b>50-1</b>



# TABLE OF CONTENTS

---

INTERACTIVE DRIVER COMMANDS.....	50-2
APPENDIX L: VDA DATABASE .....	51-1
APPENDIX M: COMMANDS FOR TWO-DIMENSIONAL REZONING .....	52-1
REZONING COMMANDS BY FUNCTION .....	52-2
APPENDIX N: RIGID BODY DUMMIES .....	53-1
APPENDIX O: LS-DYNA MPP USER GUIDE .....	54-1
SUPPORTED FEATURES .....	54-1
CONTACT INTERFACES .....	54-1
OUTPUT FILES AND POST-PROCESSING .....	54-2
PARALLEL SPECIFIC OPTIONS.....	54-3
PFILE.....	54-3
SPECIAL DECOMPOSITIONS.....	54-7
EXECUTION OF MPP/LS-DYNA.....	54-11
APPENDIX P: IMPLICIT SOLVER .....	55-1
INTRODUCTION.....	55-1
SETTING UP AN IMPLICIT SIMULATION.....	55-1
LINEAR EQUATION SOLVER .....	55-2
NONLINEAR EQUATION SOLVER .....	55-3
ELEMENT FORMULATIONS FOR IMPLICIT ANALYSIS .....	55-4
APPLYING LOADS DURING IMPLICIT ANALYSIS .....	55-4
AUTOMATIC TIME STEP SIZE CONTROL.....	55-5
IMPLICIT STRESS INITIALIZATION.....	55-6
TROUBLESHOOTING CONVERGENCE PROBLEMS.....	55-6
APPENDIX Q: USER DEFINED WELD FAILURE.....	56-1
APPENDIX R: USER DEFINED COHESIVE MODEL.....	57-1
APPENDIX S: USER DEFINED BOUNDARY FLUX.....	58-1



## LS-DYNA USER'S MANUAL

### INTRODUCTION

#### CHRONOLOGICAL HISTORY

DYNA3D originated at the Lawrence Livermore National Laboratory [Hallquist 1976]. The early applications were primarily for the stress analysis of structures subjected to a variety of impact loading. These applications required what was then significant computer resources, and the need for a much faster version was immediately obvious. Part of the speed problem was related to the inefficient implementation of the element technology which was further aggravated by the fact that supercomputers in 1976 were much slower than today's PC. Furthermore, the primitive sliding interface treatment could only treat logically regular interfaces that are uncommon in most finite element discretizations of complicated three-dimensional geometries; consequently, defining a suitable mesh for handling contact was often very difficult. The first version contained trusses, membranes, and a choice of solid elements. The solid elements ranged from a one-point quadrature eight-noded element with hourglass control to a twenty-noded element with eight integration points. Due to the high cost of the twenty node solid, the zero energy modes related to the reduced 8-point integration, and the high frequency content which drove the time step size down, higher order elements were all but abandoned in later versions of DYNA3D. A two-dimensional version, DYNA2D, was developed concurrently.

A new version of DYNA3D was released in 1979 that was programmed to provide near optimal speed on the CRAY-1 supercomputers, contained an improved sliding interface treatment that permitted triangular segments and was an order of magnitude faster than the previous contact treatment. The 1979 version eliminated structural and higher order solid elements and some of the material models of the first version. This version also included an optional element-wise implementation of the integral difference method developed by Wilkins et al. [1974].

The 1981 version [Hallquist 1981a] evolved from the 1979 version. Nine additional material models were added to allow a much broader range of problems to be modeled including explosive-structure and soil-structure interactions. Body force loads were implemented for angular velocities and base accelerations. A link was also established from the 3D Eulerian code, JOY [Couch, et. al., 1983] for studying the structural response to impacts by penetrating projectiles. An option was provided for storing element data on disk thereby doubling the capacity of DYNA3D.

The 1982 version of DYNA3D [Hallquist 1982] accepted DYNA2D [Hallquist 1980] material input directly. The new organization was such that equations of state and constitutive models of any complexity could be easily added. Complete vectorization of the material models had been nearly achieved with about a 10 percent increase in execution speed over the 1981 version.

# INTRODUCTION

---

In the 1986 version of DYNA3D [Hallquist and Benson 1986], many new features were added, including beams, shells, rigid bodies, single surface contact, interface friction, discrete springs and dampers, optional hourglass treatments, optional exact volume integration, and VAX/ VMS, IBM, UNIX, COS operating systems compatibility, that greatly expanded its range of applications. DYNA3D thus became the first code to have a general single surface contact algorithm.

In the 1987 version of DYNA3D [Hallquist and Benson 1987] metal forming simulations and composite analysis became a reality. This version included shell thickness changes, the Belytschko-Tsay shell element [Belytschko and Tsay, 1981], and dynamic relaxation. Also included were non-reflecting boundaries, user specified integration rules for shell and beam elements, a layered composite damage model, and single point constraints.

New capabilities added in the 1988 DYNA3D [Hallquist 1988] version included a cost effective resultant beam element, a truss element, a  $C^0$  triangular shell, the BCIZ triangular shell [Bazeley et al. 1965], mixing of element formulations in calculations, composite failure modeling for solids, noniterative plane stress plasticity, contact surfaces with spot welds, tie break sliding surfaces, beam surface contact, finite stonewalls, stonewall reaction forces, energy calculations for all elements, a crushable foam constitutive model, comment cards in the input, and one-dimensional slidelines.

By the end of 1988 it was obvious that a much more concentrated effort would be required in the development of this software if problems in crashworthiness were to be properly solved; therefore, Livermore Software Technology Corporation was founded to continue the development of DYNA3D as a commercial version called LS-DYNA3D which was later shortened to LS-DYNA. The 1989 release introduced many enhanced capabilities including a one-way treatment of slide surfaces with voids and friction; cross-sectional forces for structural elements; an optional user specified minimum time step size for shell elements using elastic and elastoplastic material models; nodal accelerations in the time history database; a compressible Mooney-Rivlin material model; a closed-form update shell plasticity model; a general rubber material model; unique penalty specifications for each slide surface; external work tracking; optional time step criterion for 4-node shell elements; and internal element sorting to allow full vectorization of right-hand-side force assembly.

During the last ten years, considerable progress has been made as may be seen in the chronology of the developments which follows.

Capabilities added in 1989-1990:

- arbitrary node and element numbers,
- fabric model for seat belts and airbags,
- composite glass model,
- vectorized type 3 contact and single surface contact,
- many more I/O options,
- all shell materials available for 8 node thick shell,
- strain rate dependent plasticity for beams,
- fully vectorized iterative plasticity,
- interactive graphics on some computers,

- nodal damping,
- shell thickness taken into account in shell type 3 contact,
- shell thinning accounted for in type 3 and type 4 contact,
- soft stonewalls,
- print suppression option for node and element data,
- massless truss elements, rivets – based on equations of rigid body dynamics,
- massless beam elements, spot welds – based on equations of rigid body dynamics,
- expanded databases with more history variables and integration points,
- force limited resultant beam,
- rotational spring and dampers, local coordinate systems for discrete elements,
- resultant plasticity for  $C^0$  triangular element,
- energy dissipation calculations for stonewalls,
- hourglass energy calculations for solid and shell elements,
- viscous and Coulomb friction with arbitrary variation over surface,
- distributed loads on beam elements,
- Cowper and Symonds strain rate model,
- segmented stonewalls,
- stonewall Coulomb friction,
- stonewall energy dissipation,
- airbags (1990),
- nodal rigid bodies,
- automatic sorting of triangular shells into  $C^0$  groups,
- mass scaling for quasi static analyses,
- user defined subroutines,
- warpage checks on shell elements,
- thickness consideration in all contact types,
- automatic orientation of contact segments,
- sliding interface energy dissipation calculations,
- nodal force and energy database for applied boundary conditions,
- defined stonewall velocity with input energy calculations,

## Capabilities added in 1991-1992:

- rigid/deformable material switching,
- rigid bodies impacting rigid walls,
- strain-rate effects in metallic honeycomb model 26,
- shells and beams interfaces included for subsequent component analyses,
- external work computed for prescribed displacement/velocity/accelerations,
- linear constraint equations,
- MPGS database,
- MOVIE database,
- Slideline interface file,
- automated contact input for all input types,
- automatic single surface contact without element orientation,
- constraint technique for contact,
- cut planes for resultant forces,
- crushable cellular foams,
- urethane foam model with hysteresis,
- subcycling,
- friction in the contact entities,
- strains computed and written for the 8 node thick shells,
- “good” 4 node tetrahedron solid element with nodal rotations,
- 8 node solid element with nodal rotations,

# INTRODUCTION

---

- 2x2 integration for the membrane element,
- Belytschko-Schwer integrated beam,
- thin-walled Belytschko-Schwer integrated beam,
- improved TAURUS database control,
- null material for beams to display springs and seatbelts in TAURUS,
- parallel implementation on Crays and SGI computers,
- coupling to rigid body codes,
- seat belt capability.

Capabilities added in 1993-1994:

- Arbitrary Lagrangian Eulerian brick elements,
- Belytschko-Wong-Chiang quadrilateral shell element,
- Warping stiffness in the Belytschko-Tsay shell element,
- Fast Hughes-Liu shell element,
- Fully integrated thick shell element,
- Discrete 3D beam element,
- Generalized dampers,
- Cable modeling,
- Airbag reference geometry,
- Multiple jet model,
- Generalized joint stiffnesses,
- Enhanced rigid body to rigid body contact,
- Orthotropic rigid walls,
- Time zero mass scaling,
- Coupling with USA (Underwater Shock Analysis),
- Layered spot welds with failure based on resultants or plastic strain,
- Fillet welds with failure,
- Butt welds with failure,
- Automatic eroding contact,
- Edge-to-edge contact,
- Automatic mesh generation with contact entities,
- Drawbead modeling,
- Shells constrained inside brick elements,
- NIKE3D coupling for springback,
- Barlat's anisotropic plasticity,
- Superplastic forming option,
- Rigid body stoppers,
- Keyword input,
- Adaptivity,
- First MPP (Massively Parallel) version with limited capabilities.
- Built in least squares fit for rubber model constitutive constants,
- Large hysteresis in hyperelastic foam,
- Bilhku/Dubois foam model,
- Generalized rubber model,

Capabilities added in 1995:

- Belytschko - Leviathan Shell
- Automatic switching between rigid and deformable bodies.
- Accuracy on SMP machines to give identical answers on one, two or more processors.
- Local coordinate systems for cross-section output can be specified.
- Null material for shell elements.

# INTRODUCTION

---

- Global body force loads now may be applied to a subset of materials.
- User defined loading subroutine.
- Improved interactive graphics.
- New initial velocity options for specifying rotational velocities.
- Geometry changes after dynamic relaxation can be considered for initial velocities..
- Velocities may also be specified by using material or part ID's.
- Improved speed of brick element hourglass force and energy calculations.
- Pressure outflow boundary conditions have been added for the ALE options.
- More user control for hourglass control constants for shell elements.
- Full vectorization in constitutive models for foam, models 57 and 63.
- Damage mechanics plasticity model, material 81,
- General linear viscoelasticity with 6 term prony series.
- Least squares fit for viscoelastic material constants.
- Table definitions for strain rate effects in material type 24.
- Improved treatment of free flying nodes after element failure.
- Automatic projection of nodes in CONTACT\_TIED to eliminate gaps in the surface.
- More user control over contact defaults.
- Improved interpenetration warnings printed in automatic contact.
- Flag for using actual shell thickness in single surface contact logic rather than the default.
- Definition by exempted part ID's.
- Airbag to Airbag venting/segmented airbags are now supported.
- Airbag reference geometry speed improvements by using the reference geometry for the time step size calculation.
- Isotropic airbag material may now be directly for cost efficiency.
- Airbag fabric material damping is specified as the ratio of critical damping.
- Ability to attach jets to the structure so the airbag, jets, and structure to move together.
- PVM 5.1 Madymo coupling is available.
- Meshes are generated within LS-DYNA3D for all standard contact entities.
- Joint damping for translational motion.
- Angular displacements, rates of displacements, damping forces, etc. in JNTFORC file.
- Link between LS-NIKE3D to LS-DYNA3D via \*INITIAL\_STRESS keywords.
- Trim curves for metal forming springback.
- Sparse equation solver for springback.
- Improved mesh generation for IGES and VDA provides a mesh that can directly be used to model tooling in metal stamping analyses.
- Capabilities added in 1996-1997 in Version 940:
- Part/Material ID's may be specified with 8 digits.
- Rigid body motion can be prescribed in a local system fixed to the rigid body.
- Nonlinear least squares fit available for the Ogden rubber model.
- Least squares fit to the relaxation curves for the viscoelasticity in rubber.
- Fu-Chang rate sensitive foam.
- 6 term Prony series expansion for rate effects in model 57-now 73
- Viscoelastic material model 76 implemented for shell elements.
- Mechanical threshold stress (MTS) plasticity model for rate effects.
- Thermoelastic-plastic material model for Hughes-Liu beam element.
- Ramberg-Osgood soil model
- Invariant local coordinate systems for shell elements are optional.
- Second order accurate stress updates.
- Four noded, linear, tetrahedron element.
- Co-rotational solid element for foam that can invert without stability problems.
- Improved speed in rigid body to rigid body contacts.
- Improved searching for the a\_3, a\_5 and a10 contact types.
- Invariant results on shared memory parallel machines with the a\_n contact types.
- Thickness offsets in type 8 and 9 tie break contact algorithms.

# INTRODUCTION

---

- Bucket sort frequency can be controlled by a load curve for airbag applications.
- In automatic contact each part ID in the definition may have unique:
  - Static coefficient of friction
  - Dynamic coefficient of friction
  - Exponential decay coefficient
  - Viscous friction coefficient
  - Optional contact thickness
  - Optional thickness scale factor
  - Local penalty scale factor
- Automatic beam-to-beam, shell edge-to-beam, shell edge-to-shell edge and single surface contact algorithm.
- Release criteria may be a multiple of the shell thickness in types a\_3, a\_5, a10, 13, and 26 contact.
- Force transducers to obtain reaction forces in automatic contact definitions. Defined manually via segments, or automatically via part ID's.
- Searching depth can be defined as a function of time.
- Bucket sort frequency can be defined as a function of time.
- Interior contact for solid (foam) elements to prevent "negative volumes."
- Locking joint
- Temperature dependent heat capacity added to Wang-Nefske inflator models.
- Wang Hybrid inflator model [Wang, 1996] with jetting options and bag-to-bag venting.
- Aspiration included in Wang's hybrid model [Nusholtz, Wang, Wylie, 1996].
- Extended Wang's hybrid inflator with a quadratic temperature variation for heat capacities [Nusholtz, 1996].
- Fabric porosity added as part of the airbag constitutive model .
- Blockage of vent holes and fabric in contact with structure or itself considered in venting with leakage of gas.
- Option to delay airbag liner with using the reference geometry until the reference area is reached.
- Birth time for the reference geometry.
- Multi-material Euler/ALE fluids,
  - 2nd order accurate formulations.
  - Automatic coupling to shell, brick, or beam elements
  - Coupling using LS-DYNA contact options.
  - Element with fluid + void and void material
  - Element with multi-materials and pressure equilibrium
- Nodal inertia tensors.
- 2D plane stress, plane strain, rigid, and axisymmetric elements
- 2D plane strain shell element
- 2D axisymmetric shell element.
- Full contact support in 2D, tied, sliding only, penalty and constraint techniques.
- Most material types supported for 2D elements.
- Interactive remeshing and graphics options available for 2D.
- Subsystem definitions for energy and momentum output.
- Boundary element method for incompressible fluid dynamics and fluid-structure interaction problems.

Capabilities added during 1997-1998 in Version 950:

- Adaptive refinement can be based on tooling curvature with FORMING contact.
- The display of drawbeads is now possible since the drawbead data is output into the D3PLOT database.



# INTRODUCTION

---

- An adaptive box option, \*DEFINE\_BOX\_ADAPTIVE, allows control over the refinement level and location of elements to be adapted.
- A root identification file, ADAPT.RID, gives the parent element ID for adapted elements.
- Draw bead box option, \*DEFINE\_BOX\_DRAWBEAD, simplifies drawbead input.
- The new control option, CONTROL\_IMPLICIT, activates an implicit solution scheme.
- 2D Arbitrary-Lagrangian-Eulerian elements are available.
- 2D automatic contact is defined by listing part ID's.
- 2D r-adaptivity for plane strain and axisymmetric forging simulations is available.
- 2D automatic non-interactive rezoning as in LS-DYNA2D.
- 2D plane strain and axisymmetric element with 2x2 selective-reduced integration are implemented.
- Implicit 2D solid and plane strain elements are available.
- Implicit 2D contact is available.
- The new keyword, \*DELETE\_CONTACT\_2DAUTO, allows the deletion of 2D automatic contact definitions.
- The keyword, \*LOAD\_BEAM is added for pressure boundary conditions on 2D elements.
- A viscoplastic strain rate option is available for materials:
  - \*MAT\_PLASTIC\_KINEMATIC
  - \*MAT\_JOHNSON\_COOK
  - \*MAT\_POWER\_LAW\_PLASTICITY
  - \*MAT\_STRAIN\_RATE\_DEPENDENT\_PLASTICITY
  - \*MAT\_PIECEWISE\_LINEAR\_PLASTICITY
  - \*MAT\_RATE\_SENSITIVE\_POWERLAW\_PLASTICITY
  - \*MAT\_ZERILLI-ARMSTRONG
  - \*MAT\_PLASTICITY\_WITH\_DAMAGE
  - \*MAT\_PLASTICITY\_COMPRESSION\_TENSION
- Material model, \*MAT\_Plasticity\_with\_DAMAGE, has a piecewise linear damage curve given by a load curve ID.
- The Arruda-Boyce hyper-viscoelastic rubber model is available, see \*MAT\_ARRUDA\_BOYCE.
- Transverse-anisotropic-viscoelastic material for heart tissue, see \*MAT\_HEART\_TISSUE.
- Lung hyper-viscoelastic material, see \*MAT\_LUNG\_TISSUE.
- Compression/tension plasticity model, see \*MAT\_Plasticity\_COMPRESSION\_TENSION.
- The Lund strain rate model, \*MAT\_STEINBERG\_LUND, is added to Steinberg-Guinan plasticity model.
- Rate sensitive foam model, \*MAT\_FU\_CHANG\_FOAM, has been extended to include engineering strain rates, etc.
- Model, \*MAT\_MODIFIED\_Piecewise\_Linear\_Plasticity, is added for modeling the failure of aluminum.
- Material model, \*MAT\_SPECIAL\_ORTHOTROPIC, added for television shadow mask problems.
- Erosion strain is implemented for material type, \*MAT\_bamman\_damage.
- The equation of state, \*EOS\_JWLB, is available for modeling the expansion of explosive gases.
- The reference geometry option is extended for foam and rubber materials and can be used for stress initialization, see \*INITIAL\_FOAM\_REFERENCE\_GEOMETRY.
- A vehicle positioning option is available for setting the initial orientation and velocities, see \*INITIAL\_VEHICLE\_KINEMATICS.
- A boundary element method is available for incompressible fluid dynamics problems.
- The thermal materials work with instantaneous coefficients of thermal expansion:
  - \*MAT\_ELASTIC\_PLASTIC\_THERMAL

# INTRODUCTION

---

- \*MAT\_ORTHOTROPIC\_THERMAL
- \*MAT\_TEMPERATURE\_DEPENDENT\_ORTHOTROPIC
- \*MAT\_ELASTIC\_WITH\_VISCOSITY
- Airbag interaction flow rate versus pressure differences.
- Contact segment search option, [bricks first optional]
- A through thickness Gauss integration rule with 1-10 points is available for shell elements. Previously, 5 were available.
- Shell element formulations can be changed in a full deck restart.
- The tied interface which is based on constraint equations, TIED\_SURFACE\_TO\_SURFACE, can now fail if \_FAILURE, is appended.
- A general failure criteria for solid elements is independent of the material type, see \*MAT\_ADD\_EROSION
- Load curve control can be based on thinning and a flow limit diagram, see \*DEFINE\_CURVE\_FEEDBACK.
- An option to filter the spotweld resultant forces prior to checking for failure has been added the the option, \*CONSTRAINED\_SPOTWELD, by appending, \_FILTERED\_FORCE, to the keyword.
- Bulk viscosity is available for shell types 1, 2, 10, and 16.
- When defining the local coordinate system for the rigid body inertia tensor a local coordinate system ID can be used. This simplifies dummy positioning.
- Prescribing displacements, velocities, and accelerations is now possible for rigid body nodes.
- One way flow is optional for segmented airbag interactions.
- Pressure time history input for airbag type, LINEAR\_FLUID, can be used.
- An option is available to independently scale system damping by part ID in each of the global directions.
- An option is available to independently scale global system damping in each of the global directions.
- Added option to constrain global DOF along lines parallel with the global axes. The keyword is \*CONSTRAINED\_GLOBAL. This option is useful for adaptive remeshing.
- Beam end code releases are available, see \*ELEMENT\_BEAM.
- An initial force can be directly defined for the cable material, \*MAT\_CABLE\_DISCRETE\_BEAM. The specification of slack is not required if this option is used.
- Airbag pop pressure can be activated by accelerometers.
- Termination may now be controlled by contact, via \*TERMINATION\_CONTACT.
- Modified shell elements types 8, 10 and the warping stiffness option in the Belytschko-Tsay shell to ensure orthogonality with rigid body motions in the event that the shell is badly warped. This is optional in the Belytschko-Tsay shell and the type 10 shell.
- A one point quadrature brick element with an exact hourglass stiffness matrix has been implemented for implicit and explicit calculations.
- Automatic file length determination for D3PLOT binary database is now implemented. This insures that at least a single state is contained in each D3PLOT file and eliminates the problem with the states being split between files.
- The dump files, which can be very large, can be placed in another directory by specifying d=/home/user /test/d3dump on the execution line.
- A print flag controls the output of data into the MATSUM and RBDOUT files by part ID's. The option, PRINT, has been added as an option to the \*PART keyword.
- Flag has been added to delete material data from the D3THDT file. See \*DATABASE\_EXTENT\_BINARY and column 25 of the 19th control card in the structured input.
- After dynamic relaxation completes, a file is written giving the displaced state which can be used for stress initialization in later runs.

# INTRODUCTION

---

Capabilities added during 1998-2000 in Version 960. Most new capabilities work on both the MPP and SMP versions; however, the capabilities that are implemented for the SMP version only, which were not considered critical for this release, are flagged below. These SMP unique capabilities are being extended for MPP calculations and will be available in the near future. The implicit capabilities for MPP require the development of a scalable eigenvalue solver, which is under development for a later release of LS-DYNA.

- Incompressible flow solver is available. Structural coupling is not yet implemented.
- Adaptive mesh coarsening can be done before the implicit springback calculation in metal forming applications.
- Two-dimensional adaptivity can be activated in both implicit and explicit calculations. (SMP version only)
- An internally generated smooth load curve for metal forming tool motion can be activated with the keyword: \*DEFINE\_CURVE\_SMOOTH.
- Torsional forces can be carried through the deformable spot welds by using the contact type: \*CONTACT\_SPOTWELD\_WITH\_TORSION (SMP version only with a high priority for the MPP version if this option proves to be stable.)
- Tie break automatic contact is now available via the \*CONTACT\_AUTOMATIC\_...\_TIEBREAK options. This option can be used for glued panels. (SMP only)
- \*CONTACT\_RIGID\_SURFACE option is now available for modeling road surfaces (SMP version only).
- Fixed rigid walls PLANAR and PLANAR\_FINITE are represented in the binary output file by a single shell element.
- Interference fits can be modeled with the INTERFERENCE option in contact.
- A layered shell theory is implemented for several constitutive models including the composite models to more accurately represent the shear stiffness of laminated shells.
- Damage mechanics is available to smooth the post-failure reduction of the resultant forces in the constitutive model \*MAT\_SPOTWELD\_DAMAGE.
- Finite elastic strain isotropic plasticity model is available for solid elements. \*MAT\_FINITE\_ELASTIC\_STRAIN\_PLASTICITY.
- A shape memory alloy material is available: \*MAT\_SHAPE\_MEMORY.
- Reference geometry for material, \*MAT\_MODIFIED\_HONEYCOMB, can be set at arbitrary relative volumes or when the time step size reaches a limiting value. This option is now available for all element types including the fully integrated solid element.
- Non orthogonal material axes are available in the airbag fabric model. See \*MAT\_FABRIC.
- Other new constitutive models include for the beam elements:
  - \*MAT\_MODIFIED\_FORCE\_LIMITED
  - \*MAT\_SEISMIC\_BEAM
  - \*MAT\_CONCRETE\_BEAM
- for shell and solid elements:
  - \*MAT\_ELASTIC\_VISCOPLASTIC\_THERMAL
- for the shell elements:
  - \*MAT\_GURSON
  - \*MAT\_GEPLASTIC\_SRATE2000
  - \*MAT\_ELASTIC\_VISCOPLASTIC\_THERMAL
  - \*MAT\_COMPOSITE\_LAYUP
  - \*MAT\_COMPOSITE\_LAYUP
  - \*MAT\_COMPOSITE\_DIRECT
- for the solid elements:
  - \*MAT\_JOHNSON\_HOLMQUIST\_CERAMICS
  - \*MAT\_JOHNSON\_HOLMQUIST\_CONCRETE
  - \*MAT\_INV\_HYPERBOLIC\_SIN

# INTRODUCTION

---

- \*MAT\_UNIFIED\_CREEP
- \*MAT\_SOIL\_BRICK
- \*MAT\_DRUCKER\_PRAGER
- \*MAT\_RC\_SHEAR\_WALL
- and for all element options a very fast and efficient version of the Johnson-Cook plasticity model is available:
- \*MAT\_SIMPLIFIED\_JOHNSON\_COOK
- A fully integrated version of the type 16 shell element is available for the resultant constitutive models.
- A nonlocal failure theory is implemented for predicting failure in metallic materials. The keyword \*MAT\_NONLOCAL activates this option for a subset of elastoplastic constitutive models.
- A discrete Kirchhoff triangular shell element (DKT) for explicit analysis with three in plane integration points is flagged as a type 17 shell element. This element has much better bending behavior than the C0 triangular element.
- A discrete Kirchhoff linear triangular and quadrilateral shell element is available as a type 18 shell. This shell is for extracting normal modes and static analysis.
- A C0 linear 4-node quadrilateral shell element is implemented as element type 20 with drilling stiffness for normal modes and static analysis.
- An assumed strain linear brick element is available for normal modes and statics.
- The fully integrated thick shell element has been extended for use in implicit calculations.
- A fully integrated thick shell element based on an assumed strain formulation is now available. This element uses a full 3D constitutive model which includes the normal stress component and, therefore, does not use the plane stress assumption.
- The 4-node constant strain tetrahedron element has been extended for use in implicit calculations.
- Relative damping between parts is available, see \*DAMPING\_RELATIVE (SMP only).
- Preload forces can be input for the discrete beam elements.
- Objective stress updates are implemented for the fully integrated brick shell element.
- Acceleration time histories can be prescribed for rigid bodies.
- Prescribed motion for nodal rigid bodies is now possible.
- Generalized set definitions, i.e., SET\_SHELL\_GENERAL etc. provide much flexibility in the set definitions.
- The command "sw4." will write a state into the dynamic relaxation file, D3DRLF, during the dynamic relaxation phase if the D3DRLF file is requested in the input.
- Added mass by PART ID is written into the MATSUM file when mass scaling is used to maintain the time step size, (SMP version only).
- Upon termination due to a large mass increase during a mass scaled calculation a print summary of 20 nodes with the maximum added mass is printed.
- Eigenvalue analysis of models containing rigid bodies is now available using BCSLIB-EXT solvers from Boeing. (SMP version only).
- Second order stress updates can be activated by part ID instead of globally on the \*CONTROL\_ACCURACY input.
- Interface frictional energy is optionally computed for heat generation and is output into the interface force file (SMP version only).
- The interface force binary database now includes the distance from the contact surface for the FORMING contact options. This distance is given after the nodes are detected as possible contact candidates. (SMP version only).
- Type 14 acoustic brick element is implemented. This element is a fully integrated version of type 8, the acoustic element (SMP version only).
- A flooded surface option for acoustic applications is available (SMP version only).
- Attachment nodes can be defined for rigid bodies. This option is useful for NVH applications.

# INTRODUCTION

---

- `CONSTRAINED_POINTS` tie any two points together. These points must lie on a shell elements.
- Soft constraint is available for edge to edge contact in type 26 contact.
- `CONSTAINED_INTERPOLATION` option for beam to solid interfaces and for spreading the mass and loads. (SMP version only).
- A database option has been added that allows the output of added mass for shell elements instead of the time step size.
- A new contact option allows the inclusion of all internal shell edges in contact type `*CONTACT_GENERAL`, type 26. This option is activated by adding `_INTERIOR` after the `GENERAL` keyword.
- A new option allows the use deviatoric strain rates rather than total rates in material model 24 for the Cowper-Symonds rate model.
- The CADFEM option for ASCII databases is now the default. Their option includes more significant figures in the output files.
- When using deformable spot welds, the added mass for spot welds is now printed for the case where global mass scaling is activated. This output is in the log file, D3HSP file, and the MESSAG file.
- Initial penetration warnings for edge-to-edge contact are now written into the MESSAG file and the D3HSP file.
- Each compilation of LS-DYNA is given a unique version number.
- Finite length discrete beams with various local axes options are now available for material types 66, 67, 68, 93, and 95. In this implementation the absolute value of `SCOOR` must be set to 2 or 3 in the `*SECTION_BEAM` input.
- New discrete element constitutive models are available:
  - `*MAT_ELASTIC_SPRING_DISCRETE_BEAM`
  - `*MAT_INELASTIC_SPRING_DISCRETE_BEAM`
  - `*MAT_ELASTIC_6DOF_SPRING_DISCRETE_BEAM`
  - `*MAT_INELASTIC_6DOF_SPRING_DISCRETE_BEAM`
- The latter two can be used as finite length beams with local coordinate systems.
- Moving SPC's are optional in that the constraints are applied in a local system that rotates with the 3 defining nodes.
- A moving local coordinate system, `CID`, can be used to determine orientation of discrete beam elements.
- Modal superposition analysis can be performed after an eigenvalue analysis. Stress recovery is based on type 18 shell and brick (SMP only).
- Rayleigh damping input factor is now input as a fraction of critical damping, i.e. 0.10. The old method required the frequency of interest and could be highly unstable for large input values.
- Airbag option "`SIMPLE_PRESSURE_VOLUME`" allows for the constant `CN` to be replaced by a load curve for initialization. Also, another load curve can be defined which allows `CN` to vary as a function of time during dynamic relaxation. After dynamic relaxation `CN` can be used as a fixed constant or load curve.
- Hybrid inflator model utilizing `CHEMKIN` and `NIST` databases is now available. Up to ten gases can be mixed.
- Option to track initial penetrations has been added in the automatic SMP contact types rather than moving the nodes back to the surface. This option has been available in the MPP contact for some time. This input can be defined on the fourth card of the `*CONTROL_CONTACT` input and on each contact definition on the third optional card in the `*CONTACT` definitions.
- If the average acceleration flag is active, the average acceleration for rigid body nodes is now written into the `D3THDT` and `NODOUT` files. In previous versions of LS-DYNA, the accelerations on rigid nodes were not averaged.
- A capability to initialize the thickness and plastic strain in the crash model is available through the option `*INCLUDE_STAMPED_PART`, which takes the results from the LS-

# INTRODUCTION

---

DYNA stamping simulation and maps the thickness and strain distribution onto the same part with a different mesh pattern.

- A capability to include finite element data from other models is available through the option, \*INCLUDE\_TRANSFORM. This option will take the model defined in an INCLUDE file: offset all ID's; translate, rotate, and scale the coordinates; and transform the constitutive constants to another set of units.

Many new capabilities were added during 2001-2002 to create version 970 of LS-DYNA. Some of the new features, which are also listed below, were also added to later releases of version 960. Most new explicit capabilities work for both the MPP and SMP versions; however, the implicit capabilities for MPP require the development of a scalable eigenvalue solver and a parallel implementation of the constraint equations into the global matrices. This work is underway. A later release of version 970 is planned in 2003 that will be scalable for implicit solutions.

Below is list of new capabilities and features:

- MPP decomposition can be controlled using \*CONTROL\_MPP\_DECOMPOSITION commands in the input deck.
- The MPP arbitrary Lagrangian-Eulerian fluid capability now works for airbag deployment in both SMP and MPP calculations.
- Euler-to-Euler coupling is now available through the keyword \*CONSTRAINED\_EULER\_TO\_EULER.
- Up to ten ALE multi-material groups may now be defined. The previous limit was three groups.
- Volume fractions can be automatically assigned during initialization of multi-material cells. See the GEOMETRY option of \*INITIAL\_VOLUME\_FRACTION.
- A new ALE smoothing option is available to accurately predict shock fronts.
- DATABASE\_FSI activates output of fluid-structure interaction data to ASCII file DBFSI.
- Point sources for airbag inflators are available. The origin and mass flow vector of these inflators are permitted to vary with time.
- A majority of the material models for solid materials are available for calculations using the SPH (Smooth Particle Hydrodynamics) option.
- The Element Free Galerkin method (EFG or meshfree) is available for two-dimensional and three-dimensional solids. This new capability is not yet implemented for MPP applications.
- A binary option for the ASCII files is now available. This option applies to all ASCII files and results in one binary file that contains all the information normally spread between a large number of separate ASCII files.
- Material models can now be defined by numbers rather than long names in the keyword input. For example the keyword \*MAT\_PIECEWISE\_LINEAR\_PLASTICITY can be replaced by the keyword: \*MAT\_024.
- An embedded NASTRAN reader for direct reading of NASTRAN input files is available. This option allows a typical input file for NASTRAN to be read directly and used without additional input. See the \*INCLUDE\_NASTRAN keyword.
- Names in the keyword input can represent numbers if the \*PARAMETER option is used to relate the names and the corresponding numbers.
- Model documentation for the major ASCII output files is now optional. This option allows descriptors to be included within the ASCII files that document the contents of the file.
- ID's have been added to the following keywords:
  - \*BOUNDARY\_PRESCRIBED\_MOTION

- \*BOUNDARY\_PRESCRIBED\_SPC
- \*CONSTRAINED\_GENERALIZED\_WELD
- \*CONSTRAINED\_JOINT
- \*CONSTRAINED\_NODE\_SET
- \*CONSTRAINED\_RIVET
- \*CONSTRAINED\_SPOTWELD
- \*DATABASE\_CROSS\_SECTION
- \*ELEMENT\_MASS
- The \*DATABASE\_ADAMS keyword is available to output a modal neutral file d3mnf. This will be available upon customer request since it requires linking to an ADAMS library file.
- Penetration warnings for the contact option, ignore initial penetration,  $\hat{i}$  are added as an option. Previously, no penetration warnings were written when this contact option was activated.
- Penetration warnings for nodes in-plane with shell mid-surface are printed for the AUTOMATIC contact options. Previously, these nodes were ignored since it was assumed that they belonged to a tied interface where an offset was not used; consequently, they should not be treated in contact.
- For the arbitrary spot weld option, the spot welded nodes and their contact segments are optionally written into the D3HSP file. See \*CONTROL\_CONTACT.
- For the arbitrary spot weld option, if a segment cannot be found for the spot welded node, an option now exists to error terminate. See \*CONTROL\_CONTACT.
- Spot weld resultant forces are written into the SWFORC file for solid elements used as spot welds.
- Solid materials have now been added to the failed element report.
- A new option for terminating a calculation is available, \*TERMINATION\_CURVE.
- A 10-noded tetrahedron solid element is available with either a 4 or 5 point integration rule. This element can also be used for implicit solutions.
- A new 4 node linear shell element is available that is based on Wilson's plate element combined with a Pian-Sumihara membrane element. This is shell type 21.
- A shear panel element has been added for linear applications. This is shell type 22. This element can also be used for implicit solutions.
- A null beam element for visualization is available. The keyword to define this null beam is \*ELEMENT\_PLOTEL. This element is necessary for compatibility with NASTRAN.
- A scalar node can be defined for spring-mass systems. The keyword to define this node is \*NODE\_SCALAR. This node can have from 1 to 6 scalar degrees-of-freedom.
- A thermal shell has been added for through-thickness heat conduction. Internally, 8 additional nodes are created, four above and four below the mid-surface of the shell element. A quadratic temperature field is modeled through the shell thickness. Internally, the thermal shell is a 12 node solid element.
- A beam OFFSET option is available for the \*ELEMENT\_BEAM definition to permit the beam to be offset from its defining nodal points. This has the advantage that all beam formulations can now be used as shell stiffeners.
- A beam ORIENTATION option for orienting the beams by a vector instead of the third node is available in the \*ELEMENT\_BEAM definition for NASTRAN compatibility.
- Non-structural mass has been added to beam elements for modeling trim mass and for NASTRAN compatibility.
- An optional checking of shell elements to avoid abnormal terminations is available. See \*CONTROL\_SHELL. If this option is active, every shell is checked each time step to see if the distortion is so large that the element will invert, which will result in an abnormal termination. If a bad shell is detected, either the shell will be deleted or the calculation will terminate. The latter is controlled by the input.

# INTRODUCTION

---

- An offset option is added to the inertia definition. See \*ELEMENT\_INERTIA\_OFFSET keyword. This allows the inertia tensor to be offset from the nodal point.
- Plastic strain and thickness initialization is added to the draw bead contact option. See \*CONTACT\_DRAWBEAD\_INITIALIZE.
- Tied contact with offsets based on both constraint equations and beam elements for solid elements and shell elements that have 3 and 6 degrees-of-freedom per node, respectively. See BEAM\_OFFSET and CONSTRAINED\_OFFSET contact options. These options will not cause problems for rigid body motions.
- The segment-based (SOFT=2) contact is implemented for MPP calculations. This enables airbags to be easily deployed on the MPP version.
- Improvements are made to segment-based contact for edge-to-edge and sliding conditions, and for contact conditions involving warped segments.
- An improved interior contact has been implemented to handle large shear deformations in the solid elements. A special interior contact algorithm is available for tetrahedron elements.
- Coupling with MADYMO 6.0 uses an extended coupling that allows users to link most MADYMO geometric entities with LS-DYNA FEM simulations. In this coupling MADYMO contact algorithms are used to calculate interface forces between the two models.
- Release flags for degrees-of-freedom for nodal points within nodal rigid bodies are available. This makes the nodal rigid body option nearly compatible with the RBE2 option in NASTRAN.
- Fast updates of rigid bodies for metalforming applications can now be accomplished by ignoring the rotational degrees-of-freedom in the rigid bodies that are typically inactive during sheet metal stamping simulations. See the keyword: \*CONTROL\_RIGID.
- Center of mass constraints can be imposed on nodal rigid bodies with the SPC option in either a local or a global coordinate system.
- Joint failure based on resultant forces and moments can now be used to simulate the failure of joints.
- CONSTRAINED\_JOINT\_STIFFNESS now has a TRANSLATIONAL option for the translational and cylindrical joints.
- Joint friction has been added using table look-up so that the frictional moment can now be a function of the resultant translational force.
- The nodal constraint options \*CONSTRAINED\_INTERPOLATION and \*CONSTRAINED\_LINEAR now have a local option to allow these constraints to be applied in a local coordinate system.
- Mesh coarsening can now be applied to automotive crash models at the beginning of an analysis to reduce computation times. See the new keyword: \*CONTROL\_COARSEN.
- Force versus time seatbelt pretensioner option has been added.
- Both static and dynamic coefficients of friction are available for seat belt slip rings. Previously, only one friction constant could be defined.
- \*MAT\_SPOTWELD now includes a new failure model with rate effects as well as additional failure options.
- Constitutive models added for the discrete beam elements:
  - \*MAT\_1DOF\_GENERALIZED\_SPRING
  - \*MAT\_GENERAL\_NONLINEAR\_6dof\_DISCRETE\_BEAM
  - \*MAT\_GENERAL\_NONLINEAR\_1dof\_DISCRETE\_BEAM
  - \*MAT\_GENERAL\_SPRING\_DISCRETE\_BEAM
  - \*MAT\_GENERAL\_JOINT\_DISCRETE\_BEAM
  - \*MAT\_SEISMIC\_ISOLATOR
- for shell and solid elements:
  - \*MAT\_plasticity\_with\_damage\_ortho
  - \*MAT\_simplified\_johnson\_cook\_orthotropic\_damage



- \*MAT\_HILL\_3R
  - \*MAT\_GURSON\_RCDC
- for the solid elements:
  - \*MAT\_SPOTWELD
  - \*MAT\_HILL\_FOAM
  - \*MAT\_WOOD
  - \*MAT\_VISCOELASTIC\_HILL\_FOAM
  - \*MAT\_LOW\_DENSITY\_SYNTHETIC\_FOAM
  - \*MAT\_RATE\_SENSITIVE\_POLYMER
  - \*MAT\_QUASILINEAR\_VISCOELASTIC
  - \*MAT\_TRANSVERSELY\_ANISOTROPIC\_CRUSHABLE\_FOAM
  - \*MAT\_VACUUM
  - \*MAT\_MODIFIED\_CRUSHABLE\_FOAM
  - \*MAT\_PITZER\_CRUSHABLE\_FOAM
  - \*MAT\_JOINTED\_ROCK
  - \*MAT\_SIMPLIFIED\_RUBBER
  - \*MAT\_FHWA\_SOIL
  - \*MAT\_SCHWER\_MURRAY\_CAP\_MODEL
- Failure time added to MAT\_EROSION for solid elements.
- Damping in the material models \*MAT\_LOW\_DENSITY\_FOAM and \*MAT\_LOW\_DENSITY\_VISCOUS\_FOAM can now be a tabulated function of the smallest stretch ratio.
- The material model \*MAT\_PLASTICITY\_WITH\_DAMAGE allows the table definitions for strain rate.
- Improvements in the option \*INCLUDE\_STAMPED\_PART now allow all history data to be mapped to the crash part from the stamped part. Also, symmetry planes can be used to allow the use of a single stamping to initialize symmetric parts.
- Extensive improvements in trimming result in much better elements after the trimming is completed. Also, trimming can be defined in either a local or global coordinate system. This is a new option in \*DEFINE\_CURVE\_TRIM.
- An option to move parts close before solving the contact problem is available, see \*CONTACT\_AUTO\_MOVE.
- An option to add or remove discrete beams during a calculation is available with the new keyword: \*PART\_SENSOR.
- Multiple jetting is now available for the Hybrid and Chemkin airbag inflator models.
- Nearly all constraint types are now handled for implicit solutions.
- Calculation of constraint and attachment modes can be easily done by using the option: \*CONTROL\_IMPLICIT\_MODES.
- Penalty option, see \*CONTROL\_CONTACT, now applies to all \*RIGIDWALL options and is always used when solving implicit problems.
- Solid elements types 3 and 4, the 4 and 8 node elements with 6 degrees-of-freedom per node are available for implicit solutions.
- The warping stiffness option for the Belytschko-Tsay shell is implemented for implicit solutions. The Belytschko-Wong-Chang shell element is now available for implicit applications. The full projection method is implemented due to its accuracy over the drill projection.
- Rigid to deformable switching is implemented for implicit solutions.
- Automatic switching can be used to switch between implicit and explicit calculations. See the keyword: \*CONTROL\_IMPLICIT\_GENERAL.
- Implicit dynamics rigid bodies are now implemented. See the keyword \*CONTROL\_IMPLICIT\_DYNAMIC.
- Eigenvalue solutions can be intermittently calculated during a transient analysis.
- A linear buckling option is implemented. See the new control input: \*CONTROL\_IMPLICIT\_BUCKLE

# INTRODUCTION

---

- Implicit initialization can be used instead of dynamic relaxation. See the keyword \*CONTROL\_DYNAMIC\_RELAXATION where the parameter, IDFLG, is set to 5.
- Superelements, i.e., \*ELEMENT\_DIRECT\_MATRIX\_INPUT, are now available for implicit applications.
- There is an extension of the option, \*BOUNDARY\_CYCLIC, to symmetry planes in the global Cartesian system. Also, automatic sorting of nodes on symmetry planes is now done by LS-DYNA.
- Modeling of wheel-rail contact for railway applications is now available, see \*RAIL\_TRACK and \*RAIL\_TRAIN.
- A new, reduced CPU, element formulation is available for vibration studies when elements are aligned with the global coordinate system. See \*SECTION\_SOLID and \*SECTION\_SHELL formulation 98.
- An option to provide approximately constant damping over a range of frequencies is implemented, see \*DAMPING\_FREQUENCY\_RANGE.

Many new capabilities were added during 2003-2005 to create version 971 of LS-DYNA. Initially, the intent was to quickly release version 971 after 970 with the implicit capabilities fully functional for distributed memory processing using MPI. Unfortunately, the effort required for parallel implicit was grossly underestimated, and, as a result, the release has been delayed. Because of the delay, version 971 has turned into a major release. Some of the new features, listed below, were also added to later releases of version 970. The new explicit capabilities are implemented in the MPP version and except for one case, in the SMP version as well.

Below is list of new capabilities and features:

- A simplified method for using the ALE capability with airbags is now available with the keyword \*AIRBAG\_ALE.
- Case control using the \*CASE keyword, which provides a way of running multiple load cases sequentially within a single run
- New option to forming contact: \*CONTACT\_FORMING\_ONE\_WAY\_SURFACE\_TO\_SURFACE\_SMOOTH, which use fitted surface in contact calculation.
- Butt weld definition by using the \*CONSTRAINED\_BUTT\_WELD option which makes the definition of butt welds simple relative to the option: \*CONSTRAINED\_GENERALIZED\_WELD\_BUTT.
- H-adaptive fusion is now possible as an option with the control input, \*CONTROL\_ADAPTIVE.
- Added a parameter on, \*CONTROL\_ADAPTIVE, to specify the number of elements generated around a 90 degree radius. A new option to better calculate the curvature was also implemented.
- Added a new keyword: \*CONTROL\_ADAPTIVE\_CURVE, to refine the element along trimming curves
- Birth and death times for implicit dynamics on the keyword \*CONTROL\_IMPLICIT\_DYNAMICS.
- Added an option to scale the spot weld failure resultants to account for the location of the weld on the segment surface, see \*CONTROL\_SPOTWELD\_BEAM.
- Added an option which automatically replaces a single beam spot weld by an assembly of solid elements using the same ID as the beam that was replaced, see \*CONTROL\_SPOTWELD\_BEAM.
- Boundary constraint in a local coordinate system using \*CONSTRAINED\_LOCAL keyword.
- A cubic spline interpolation element is now available, \*CONSTRAINED\_SPLINE.

# INTRODUCTION

---

- Static implicit analyses in of a structure with rigid body modes is possible using the option, \*CONTROL\_IMPLICIT\_INERTIA\_RELIEF.
- Shell element thickness updates can now be limited to part ID's within a specified set ID, see the \*CONTROL\_SHELL keyword. The thickness update for shells can now be optionally limited to the plastic part of the strain tensor for better stability in crash analysis.
- Solid element stresses in spot welds are optionally output in the local system using the SWLOCL parameter on the \*CONTROL\_SOLID keyword.
- SPOTHIN option on the \*CONTROL\_CONTACT keyword cards locally thins the spot welded parts to prevent premature breakage of the weld by the contact treatments.
- New function: \*CONTROL\_FORMING\_PROJECT, which can initial move the penetrating slave nodes to the master surface
- New function \*CONTROL\_FORMING\_TEMPLATE, which allows user to easily set up input deck. Its function includes auto-position, define travel curve, termination time, and most of the forming parameters for most of the typical forming process.
- New function \*CONTROL\_FORMING\_USER, \*CONTROL\_FORMING\_POSITION, and \*CONTROL\_FORMING\_TRAVEL, when used together, can allow the user to define atypical forming process.
- Added new contact type \*CONTACT\_GUIDED\_CABLE.
- Circular cut planes are available for \*DATABASE\_CROSS\_SECTION definitions.
- New binary database FSIFOR for fluid structure coupling.
- Added \*DATABASE\_BINARY\_D3PROP for writing the material and property data to the first D3PLOT file or to a new database D3PROP.
- DATABASE\_EXTENT\_BINARY has new flags to output peak pressure, surface energy density, nodal mass increase from mass scaling, thermal fluxes, and temperatures at the outer surfaces of the thermal shell.
- Eight-character alphanumeric labels can now be used for the parameters SECID, MID, EOSID, HGID, and TMID on the \*PART keyword.
- Two NODOUT files are now written: one for high frequency output and a second for low frequency output.
- Nodal mass scaling information can now be optionally written to the D3PLOT file.
- Added option, MASS\_PROPERTIES, to include the mass and inertial properties in the GLSTAT and SSSTAT files.
- Added option in \*CONTROL\_CPU to output the cpu and elapsed time into the GLSTAT file.
- Added an option, IERODE, on the \*CONTROL\_OUTPUT keyword to include eroded energies by part ID into the MATSUM file. Lumped mass kinetic energy is also in the MATSUM file as part ID 0.
- Added an option, TET10, on the \*CONTROL\_OUTPUT keyword to output ten connectivity nodes into D3PLOT database rather than 4.
- New keyword, \*ELEMENT\_SOLID\_T4TOT10 to convert 4 node tetrahedron elements to 10 node tetrahedron elements.
- New keyword, \*ELEMENT\_MASS\_PART defines the total additional non-structural mass to be distributed by an area weighted distribution to all nodes of a given part ID.
- New keyword option, SET, for \*INITIAL\_STRESS\_SHELL\_SET allows a set of shells to be initialized with the state of stress.
- New option allows the number of cpu's to be specified on the \*KEYWORD input.
- Tubular drawbead box option for defining the elements that are included in the drawbead contact, see \*DEFINE\_BOX\_DRAWBEAD.
- New function: \*DEFINE\_CURVE\_DRAWBEAD, allow user to conveniently define drawbead by using curves (in x, y format or iges format)
- New function: \*DEFINE\_DRAWBEAD\_BEAM, which allows user to conveniently define drawbead by using beam part ID, and specify the drawbead force.

# INTRODUCTION

---

- Analytic function can be used in place of load curves with the option \*DEFINE\_CURVE\_FUNCTION.
- Friction can now be defined between part pair using the \*DEFINE\_FRICTION input.
- New keyword: \*DEFINE\_CURVE\_TRIM\_3D, to allow trimming happens based on blank element normal, rather than use pre-defined direction
- A new trimming algorithm was added: \*DEFINE\_CURVE\_TRIM\_NEW, which allow seed node to be input and is much faster then the original algorithm.
- A new keyword, \*DEFINE\_HEX\_SPOTWELD\_ASSEMBLY, is available to define a cluster of solid elements that comprise a single spot weld.
- The definition of a vector, see \*DEFINE\_VECTOR, can be done by defining coordinates in a local coordinate system.
- The definition of a failure criteria between part pairs is possible with a table defined using the keyword, \*DEFINE\_SPOTWELD\_FAILURE\_RESULTANTS.
- A new keyword, \*DEFINE\_CONNECTION\_PROPERTIES is available for defining failure properties of spot welds.
- Added \*DEFINE\_SET\_ADAPTIVE to allow the adaptive level and element size to be specified by part ID or element set ID.
- Static rupture stresses for beam type spot welds can be defined in the keyword input, \*DEFINE\_SPOTWELD RUPTURE\_STRESS.
- Section properties can be define in the \*ELEMENT\_BEAM definitions for resultant beam elements using the SECTION option.
- Physical offsets of the shell reference surface can be specified on the shell element cards, see the OFFSET option on \*ELEMENT\_SHELL.
- File names can be located in remote directories and accessed through the \*INCLUDE\_PART keyword.
- New features to \*INCLUDE\_STAMPED\_PART: two different mirror options, user-defined searching radius.
- \*INITIAL\_STRESS\_SECTION allows for stress initialization across a cross-section, which consists of solid elements.
- An option, IVATN, is available for setting the velocities of slaved nodes and parts for keyword, \*INITIAL\_VELOCITY\_GENERATION.
- Twenty-two built-in cross-section are now available in the definition of beam integration rules, see \*INTEGRATION\_BEAM.
- The possibility of changing material types is now available for shells using the user defined integration rule, see \*INTEGRATION\_SHELL.
- The interface springback file created by using the keyword, \*INTERFACE\_SPRINGBACK is now optionally written as a binary file.
- An optional input line for \*KEYWORD allows the definition of a prefix for all file names created during a simulation. This allows multiple jobs to be executed in the same directory.
- Body force loads can now be applied in a local coordinate system for \*LOAD\_BODY.
- A pressure loading feature allows moving pressures to be applied to a surface to simulate spraying a surface with stream of fluid through a nozzle. See keyword \*LOAD\_MOVING\_PRESSURE.
- Thermal expansion can be added to any material by the keyword, \*MAT\_ADD\_THERMAL\_EXPANSION.
- Curves can now be used instead of eight digitized data points in the material model \*MAT\_ELASTIC\_WITH\_VISCOSITY\_CURVE
- New options for spot weld failure in \*MAT\_SPOTWELD, which apply to beam and solid elements.
- Failure criteria based on plastic strain to failure is added to material \*MAT\_ANISOTROPIC\_VISCOPLASTIC.
- Strain rate failure criterion is added to material \*MAT\_MODIFIED\_PIECEWISE\_LINEAR\_PLASTICITY.

# INTRODUCTION

---

- Strain rate scaling of the yield stress can now be done differently in tension and compression in material with separate pressure cut-offs in tension and compression in material model \*MAT\_PLASTICITY\_TENSION\_COMPRESSION.
- The RCDC model is now available to predict failure in material \*MAT\_PLASTICITY\_WITH\_DAMAGE.
- Two additional yield surfaces have been added to material \*MAT\_MODIFIED\_HONEYCOMB to provide more accurate predictions of the behavior of honeycomb barrier models.
- Unique coordinate systems can be assigned to the two nodal points of material \*MAT\_1DOF\_GENERALIZED\_SPRING.
- Poisson's ratio effects are available in foam defined by load curves in the material \*MAT\_SIMPLIFIED\_RUBBER/FOAM
- Failure effects are available in the rubber/foam material defined by load curves in the \*MAT\_SIMPLIFIED\_RUBBER/FOAM\_WITH\_FAILURE.
- The material option \*MAT\_ADD\_EROSION now allows the maximum pressure at failure and the minimum principal strain at failure to be specified.
- Strains rather than displacements can now be used with the material model for discrete beams, \*MAT\_GENERAL\_NONLINEAR\_6DOF\_DISCRETE\_BEAM.
- New option for MAT\_TRANSVERSELY\_ANISOTROPIC\_ELASTIC\_PLASTIC\_(ECHANGE), which allow two ways to change the Young's modulus during forming simulation.
- New Material model: \*MAT\_HILL\_3R: includes the shear term in the yield surface calculation by using Hill's 1948 an-isotropic material model.
- New Material model: \*MAT\_KINEMATIC\_HARDENING\_TRANSVERSELY\_ANISOTROPIC: which integrates Mat #37 with Yoshida's two-surface kinematic hardening model.
- Improved formulation for the fabric material, \*MAT\_FABRIC for formulations 2, 3, and 4. The improved formulations are types 12, 13, and 14.
- Constitutive models added for truss elements:
  - \*MAT\_MUSCLE
- For beam elements
  - \*MAT\_MOMENT\_CURVATURE
- For shell elements
  - \*MAT\_RESULTANT\_ANISOTROPIC
  - \*MAT\_RATE\_SENSITIVE\_COMPOSITE\_FABRIC.
  - \*MAT\_SAMP-1
  - \*MAT\_SHAPE\_MEMORY is now implemented for shells.
- for shell and solid elements:
  - \*MAT\_BARLAT\_YLD2000 for anisotropic aluminum alloys.
  - \*MAT\_SIMPLIFIED\_RUBBER\_WITH\_DAMAGE
  - \*MAT\_VISCOELASTIC\_THERMAL
  - \*MAT\_THERMO\_ELASTO\_VISCOPLASTIC\_CREEP
- for the solid elements:
  - \*MAT\_ARUP\_ADHESIVE
  - \*MAT\_BRAIN\_LINEAR\_VISCOELASTIC.
  - \*MAT\_CSCM for modeling concrete.
  - \*MAT\_PLASTICITY\_COMPRESSION\_TENSION\_EOS for modeling ice.
  - \*MAT\_COHESIVE\_ELASTIC
  - \*MAT\_COHESIVE\_TH
  - \*MAT\_COHESIVE\_GENERAL
  - \*MAT\_EOS\_GASKET
  - \*MAT\_SIMPLIFIED\_JOHNSON\_COOK is now implemented for solids.
  - \*MAT\_PLASTICITY\_WITH\_DAMAGE is now implemented for solids.
  - \*MAT\_SPOTWELD\_DAIMLERCHRYSLER

# INTRODUCTION

---

- User defined equations-of-state are now available.
- There is now an interface with the MOLDFLOW code.
- Damping defined in \*DAMPING\_PART\_STIFFNESS now works for the Belytschko – Schwer beam element.
- The option \*NODE\_TRANSFORMATION allows a node set to be transformed based on a transformation defined in \*DEFINE\_TRANSFORMATION.
- Parameters can be defined in FORTRAN like expressions using \*PARAMETER\_EXPRESSION.
- A part can be moved in a local coordinate system in \*PART\_MOVE.
- A simplified method for defining composite layups is available with \*PART\_COMPOSITE
- The rigid body inertia can be changed in restart via \*CHANGE\_RIGID\_BODY\_INERTIA.
- A part set can now be defined by combining other part sets in \*SET\_PART\_ADD.
- Termination of the calculation is now possible if a specified number of shell elements are deleted in a give part ID. See \*TERMINATION\_DELETED\_SHELLS.
- Added hourglass control type 7 for solid elements for use when modeling hyperelastic materials.
- Shell formulations 4, 11, 16, and 17 can now model rubber materials.
- Added a new seatbelt pretensioner type 7 in which the pretensioner and retractor forces are calculated independently and added.
- A new composite tetrahedron element made up from 12 tetrahedron is now available as solid element type 17.
- Shell thickness offsets for \*SECTION\_SHELL now works for most shell elements, not just the Hughes-Liu shell.
- The Hughes-Liu beam has been extended to include warpage for open cross-sections.
- A resultant beam formulation with warpage is available as beam type 12.
- Two nonlinear shell elements are available with 8 degrees-of-freedom per node to include thickness stretch.
- Tetrahedron type 13, which uses nodal pressures, is now implemented for implicit applications.
- Cohesive solid elements are now available for treating failure.
- Seatbelt shell elements are available for use with the all seatbelt capabilities.
- Superelements can now share degrees-of-freedom and are implemented for implicit applications under MPI.
- A user defined element interface is available for solid and shell elements.
- Thermal shells are available for treating heat flow through shell elements.
- EFG shell formulations 41 and 42 are implemented for explicit analysis.
- EFGPACK is implemented in addition to BCSLIB-EXT solver on the keyword \*CONTROL\_EFG.
- EFG MPP version is available for explicit analysis.
- EFG fast transformation method is implemented in the EFG solid formulation.
- EFG Semi-Lagrangian kernel and Eulerian kernel options are added for the foam materials.
- EFG 3D adaptivity is implemented for the metal materials.
- EFG E.O.S. and \*MAT\_ELASTIC\_FLUID materials are included in the 4-noded background element formulation.
- Airbag simulations by using ALE method can be switched to control volume method by \*ALE\_CV\_SWITCH.
- \*MAT\_ALE\_VISCOUS now supports Non-Newtonian viscosity by power law or load curve.
- \*DATABASE\_BINARY\_FSIFOR outputs fluid-structure interaction data to binary file.
- \*DATABASE\_FSI\_SENSOR outputs ALE element pressure to ASCII file dbsor.
- \*MAT\_GAS\_MIXTURE supports nonlinear heat capacities.

# INTRODUCTION

---

- \*INITIAL\_VOLUME\_FRACTION\_GEOMETRY uses an enhanced algorithm to handle both concave and convex geometries and substantially reduce run time.
- A new keyword \*DELETE\_FSI allows the deletion of coupling definitions.
- Convection heat transfer activates by \*LOAD\_ALE\_CONVECTION in ALE FSI analysis.
- \*ALE\_FSI\_SWITCH\_MMG is implemented to switch between ALE multi-material groups to treat immersed FSI problems.
- Type 9 option is added in \*ALE\_REFERENCE\_SYSTEM\_GROUP to deal complex ALE mesh motions including translation, rotation, expansion and contraction, etc.
  - New options in \*CONSTRAINED\_LAGRANGE\_IN\_SOLID
  - Shell thickness option for coupling type 4.
  - Bulk modulus based coupling stiffness.
  - Shell erosion treatment.
  - Enable/disable interface force file.
- New coupling method for fluid flowing through porous media are implemented as type 11 (shell) and type 12 (solid) in \*CONSTRAINED\_LAGRANGE\_IN\_SOLID.
- \*ALE\_MODIFIED\_STRAIN allows multiple strain fields in certain ALE elements to solve sticking behavior in FSI. (MPP underdevelopment)
- \*ALE\_FSI\_PROJECTION is added as a new constraint coupling method to solve small pressure variation problem. (MPP underdevelopment)
- \*BOUNDARY\_PRESCRIBED\_ORIENTATION\_RIGID is added as a means to prescribe as a function of time the general orientation of a rigid body using a variety of methods. This feature is available in release R3 and higher of Version 971.
- \*BOUNDARY\_PRESCRIBED\_ACCELEROMETER\_RIGID is added as a means to prescribe the motion of a rigid body based on experimental data gathered from accelerometers affixed to the rigid body. This feature is available in release R3 and higher of Version 971.

Many new capabilities were added during 2008-2011 to create Version 971, Release 6, of LS-DYNA. During the last four years the implicit capabilities are now scalable to a large number of cores; therefore, LS-DYNA has achieved a major goal over 15 years of embedding a scalable implicit solver. Also, in addition to the progress made for implicit solutions many other new and useful capabilities are now available.

Below is list of new capabilities and features:

- The keyword \*ALE\_AMBIENT\_HYDROSTATIC initializes the hydrostatic pressure field in the ambient ALE domain due to an acceleration like gravity.
- The keyword \*ALE\_FAIL\_SWITCH\_MMG allows switching an ALE multi-material-group ID (AMMGID) if the material failure criteria occurs.
- The keyword \*ALE\_FRAGMENTATION allow switching from the ALE multi-material-group ID, AMMGID, (FR\_MMG) of this failed material to another AMMGID (TO\_MMG). This feature may typically be used in simulating fragmentation of materials.
- The keyword \*ALE\_REFINE refines ALE hexahedral solid elements automatically.
- The keyword \*BOUNDARY\_ALE\_MAPPING maps ALE data histories from a previous run to a region of elements. Data are read from or written to a mapping file with a file name given by the prompt “map=” on the command line starting the execution.
- The keyword \*BOUNDARY\_PORE\_FLUID is used to define parts that contain pore fluid where defaults are given on \*CONTROL\_PORE\_FLUID input.

# INTRODUCTION

---

- With the keyword, `*BOUNDARY_PRESCRIBED_FINAL_GEOMETRY`, the final displaced geometry for a subset of nodal points is defined. The nodes of this subset are displaced from their initial positions specified in the `*NODE` input to the final geometry along a straight line trajectory. A load curve defines a scale factor as a function of time that is bounded between zero and unity corresponding to the initial and final geometry, respectively. A unique load curve can be specified for each node, or a default load curve can apply to all nodes.
- The keyword, `*BOUNDARY_PWP`, defines pressure boundary conditions for pore water at the surface of the software.
- The keyword, `*CONSTRAINED_JOINT_COOR`, defines a joint between two rigid bodies. The connection coordinates are given instead of the nodal point IDs used in `*CONSTRAINED_JOINT`.
- The keyword, `*CONSTRAINED_SPR2`, defines a self-piercing rivet with failure. This model for a self-piercing rivet (SPR2) includes a plastic-like damage model that reduces the force and moment resultants to zero as the rivet fails. The domain of influence is specified by a diameter, which should be approximately equal to the rivet's diameter. The location of the rivet is defined by a single node at the center of two riveted sheets.
- Through the keyword, `*CONTROL_BULK_VISCOSITY`, bulk viscosity is optional for the Hughes-Liu beam and beam type 11 with warpage. This option often provides better stability, especially in elastic response problems.
- The keyword, `*CONTROL_IMPLICIT_LINEAR_PARTS`, provides an extension to the implicit solution option of the explicit `*PART_MODES` capability
- The display of nodal rigid bodies is activated by the parameter, `PLOTEL`, on the `*CONTROL_RIGID` keyword.
- The mortar contact, invoked by appending the suffix `MORTAR` to either `FORMING_SURFACE_TO_SURFACE`, `AUTOMATIC_SURFACE_TO_SURFACE` or `AUTOMATIC_SINGLE_SURFACE`, is a segment to segment penalty based contact. For two segments on each side of the contact interface that are overlapping and penetrating, a consistent nodal force assembly taking into account the individual shape functions of the segments is performed. In this respect the results with this contact may be more accurate, especially when considering contact with elements of higher order. By appending the suffix `TIED` to the `CONTACT_AUTOMATIC_SURFACE_TO_SURFACE_MORTAR` keyword, this is treated as a tied contact interface. This contact is intended for implicit analysis in particular but is nevertheless supported for explicit analysis as well.
- In the database, `ELOUT`, the number of history variables can be specified for output each integration point in the solid, shell, thick shell, and beam elements. The number of variables is given on the `*DATABASE_ELOUT` keyword definition.
- A new option is available in `*DATABASE_EXTENT_BINARY`. Until now only one set of integration points were output through the shell thickness. The lamina stresses and history variables were averaged for fully integrated shell elements, which results in less disk space for the `D3PLOT` family of files, but makes it difficult to verify the accuracy of the stress calculation after averaging. An option is now available to output all integration point stresses in fully integrated shell elements: 4 x # of through thickness integration points in shell types 6, 7, 16, 18-21, and 3 x # of through thickness integration points in triangular shell types 3, and 17.
- The keyword `*DATABASE_PROFILE` allows plotting the distribution or profile of data along x, y, or z-direction.
- The purpose of the keyword, `*DEFINE_ADAPTIVE_SOLID_TO_SPH`, is to adaptively transform a Lagrangian solid Part or Part Set to SPH particles when the Lagrange solid elements comprising those parts fail. One or more SPH particles (elements) will be generated for each failed element to. The SPH particles replacing the failed element inherit all of the properties of failed solid element, e.g. mass, kinematic variables, and constitutive properties.



# INTRODUCTION

---

- With the keywords beginning with, `*DEFINE_BOX`, a `LOCAL` option is now available. With this option the diagonal corner coordinates are given in a local coordinate system defined by an origin and vector pair.
- The keyword, `*DEFINE_CURVE_DUPLICATE`, defines a curve by optionally scaling and offsetting the abscissa and ordinates of another curve defined by the `*DEFINE_CURVE` keyword.
- The keyword, `*DEFINE_ELEMENT_DEATH`, is available to delete a single element or an element set at a specified time during the calculation.
- The purpose of the keyword, `*DEFINE_FRICTION_ORIENTATION`, is to allow for the definition of different coefficients of friction (COF) in specific directions, specified using a vector and angles in degrees. In addition, COF can be scaled according to the amount of pressure generated in the contact interface.
- With the new keyword, `*DEFINE_FUNCTION`, an arithmetic expression involving a combination of independent variables and other functions, i.e.,  $f(a,b,c) = a^2 + b*c + \sqrt{a*c}$  is defined where  $a$ ,  $b$ , and  $c$  are the independent variables. This option is implemented for a subset of keywords
  - `*ELEMENT_SEATBELT_SLIPRING`
  - `*LOAD_BEAM`
  - `*LOAD_MOTION_NODE`
  - `*LOAD_MOVING_PRESSURE`
  - `*LOAD_NODE`
  - `*LOAD_SEGMENT`
  - `*LOAD_SEGMENT_NONUNIFORM`
  - `*LOAD_SETMENT_SET_NONUNIFORM`
  - `*BOUNDARY_PRESCRIBED_MOTION`If a curve ID is not found, then the function ID's are checked.
- The keyword, `*DEFINE_SPH_TO_SPH_COUPLING`, defines a penalty based contact to be used for the node to node contacts between SPH parts.
- The keyword, `*DEFINE_TABLE_2D`, permits the same curve ID to be referenced by multiple tables, and the curves may be defined anywhere in the input.
- The keyword, `*DEFINE_TABLE_3D`, provides a way of defining a three-dimensional table. A 2D table ID is specified for each abscissa value defined for the 3D table.
- The keyword, `*ELEMENT_BEAM_PULLEY`, allows the definition of a pulley for truss beam elements (see `*SECTION_BEAM`, `ELFORM=3`). Currently, the beam pulley is implemented for `*MAT_001` and `*MAT_156`. Pulleys allow continuous sliding of a string of truss beam element through a sharp change of angle.
- The purpose of the keyword, `*ELEMENT_MASS_MATRIX`, is to define a 6x6 symmetric nodal mass matrix assigned to a nodal point or each node within a node set.
- The keyword, `*ELEMENT_DISCRETE_SPHERE`, allows the definition of a discrete spherical element for discrete element calculations. Each particle consists of a single node with its mass, mass moment of inertia, and radius. Initial coordinates and velocities are specified via the nodal data.
- The two keywords, `*ELEMENT_SHELL_COMPOSITE` and `*ELEMENT_TSHELL_COMPOSITE`, are used to define elements for a general composite shell part where the shells within the part can have an arbitrary number of layers. The material ID, thickness, and material angle are specified for the thickness integration points for each shell in the part
- The keyword, `*EOS_USER_DEFINED`, allows a user to supply their own equation-of-state subroutine.
- The new keyword `*FREQUENCY_DOMAIN` provides a way of defining and solving frequency domain vibration and acoustic problems. The related keyword cards given in alphabetical order are:
  - `*FREQUENCY_DOMAIN_ACOUSTIC_BEM_{OPTION}`
  - `*FREQUENCY_DOMAIN_ACOUSTIC_FEM`

# INTRODUCTION

---

\*FREQUENCY\_DOMAIN\_FRF  
\*FREQUENCY\_DOMAIN\_RANDOM\_VIBRATION  
\*FREQUENCY\_DOMAIN\_RESPONSE\_SPECTRUM  
\*FREQUENCY\_DOMAIN\_SSD

- The keyword, \*INITIAL\_AIRBAG\_PARTICLE, initializes pressure in a closed airbag volume, door cavities for pressure sensing studies, and tires.
- The keyword \*INITIAL\_ALE\_HYDROSTATIC initializes the hydrostatic pressure field in an ALE domain due to an acceleration like gravity.
- The keyword \*INITIAL\_ALE\_MAPPING maps ALE data histories from a previous run. Data are read from a mapping file with a file name given by the prompt “map=” on the command line starting the execution.
- The keyword, \*INITIAL\_AXIAL\_FORCE\_BEAM, provides a simplified method to model initial tensile forces in bolts.
- is a simplified version of the \*INITIAL\_STRESS\_SOLID keyword which can be used with hyperelastic materials. This keyword is used for history variable input. Data is usually in the form of the eigenvalues of diffusion tensor data. These are expressed in the global coordinate system.
- The keyword, \*INITIAL\_FIELD\_SOLID, is a simplified version of the \*INITIAL\_STRESS\_SOLID keyword which can be used with hyperelastic materials. This keyword is used for history variable input. Data is usually in the form of the eigenvalues of diffusion tensor data. These are expressed in the global coordinate system.
- **The equation-of-state, \*EOS\_MIE\_GRUNEISEN**, type 16, is a Mie-Gruneisen form with a  $p$ - $\alpha$  compaction model.
- The keyword, \*LOAD\_BLAST\_ENHANCED, defines an air blast function for the application of pressure loads due the explosion of conventional charge. While similar to \*LOAD\_BLAST this feature includes enhancements for treating reflected waves, moving warheads and multiple blast sources. The loads are applied to facets defined with the keyword \*LOAD\_BLAST\_SEGMENT. A database containing blast pressure history is also available (see \*DATABASE\_BINARY\_BLASTFOR).
- The keyword, \*LOAD\_ERODING\_PART\_SET, creates pressure loads on the exposed surface composed of solid elements that erode, i.e., pressure loads are added to newly exposed surface segments as solid elements erode.
- The keyword, \*LOAD\_SEGMENT\_SET\_ANGLE, applies traction loads over a segment set that is dependent on the orientation of a vector. An example application is applying a pressure to a cylinder as a function of the crank angle in an automobile engine
- The keyword, \*LOAD\_STEADY\_STATE\_ROLLING, is a generalization of \*LOAD\_BODY, allowing the user to apply body loads to part sets due to translational and rotational accelerations in a manner that is more general than the \*LOAD\_BODY capability. The \*LOAD\_STEADY\_STATE\_ROLLING keyword may be invoked an arbitrary number of times in the problem as long as no part has the option applied more than once and they can be applied to arbitrary meshes. This option is frequently used to initialize stresses in tire.
- The keywords INTERFACE\_SSI, INTERFACE\_SSI\_AUX, INTERFACE\_SSI\_AUX\_EMBEDDED and INTERFACE\_SSI\_STATIC are used to define the soil-structure interface appropriately in various stages of soil-structure interaction analysis under earthquake ground motion.
- The keyword, \*LOAD\_SEISMIC\_SSI, is used to apply earthquake loads due to free-field earthquake ground motion at certain locations — defined by either nodes or coordinates — on a soil-structure interface. This loading is used in earthquake soil-structure interaction analysis. The specified motions are used to compute a set of effective forces in the soil elements adjacent to the soil-structure interface, according to the effective seismic input-domain reduction method.
- The keyword \*DEFINE\_GROUND\_MOTION is used to specify a ground motion to be used in conjunction with \*LOAD\_SEISMIC\_SSI.

# INTRODUCTION

---

- Material types \*MAT\_005 and \*MAT\_057 now accept table input to allow the stress quantity versus the strain measure to be defined as a function of temperature.
- The material option \*MAT\_ADD\_EROSION, can now be applied to all nonlinear shell, thick shell, fully integrated solids, and 2D solids. New failure criteria are available.
- The GISSMO damage model, now available as an option in \*MAT\_ADD\_EROSION, is a phenomenological formulation that allows for an incremental description of damage accumulation, including softening and failure. It is intended to provide a maximum in variability for the description of damage for a variety of metallic materials (e.g. \*MAT\_024, \*MAT\_036, ...). The input of parameters is based on tabulated data, allowing the user to directly convert test data to numerical input.
- The keyword, \*MAT\_RIGID\_DISCRETE or MAT\_220, eliminates the need to define a unique rigid body for each particle when modeling a large number of rigid particles. This gives a large reduction in memory and wall clock time over separate rigid bodies. A single rigid material is defined which contains multiple disjoint pieces. Input is simple and unchanged, since all disjoint rigid pieces are identified automatically during initialization.
- The keyword, \*NODE\_MERGE, causes nodes with identical coordinates to be replaced during the input phase by the node encountered that has the smallest ID, which shares the coordinate.
- The keyword, \*PART\_ANNEAL, is used to initialize the stress states at integration points within a specified part to zero at a given time during the calculation. This option is valid for parts that use constitutive models where the stress is incrementally updated. This option also applies to the Hughes-Liu beam elements, the integrated shell elements, thick shell elements, and solid elements.
- The keyword, \*PART\_DUPLICATE, provides a method of duplicating parts or part sets without the need to use the \*INCLUDE\_TRANSFORM option.
- To automatically generate elements to visualize rigid walls the DISPLAY option is now available for \*RIGIDWALL\_PLANAR and \*RIGIDWALL\_GEOMETRIC.
- A one point integrated pentahedron solid element with hourglass control is implemented as element type 115 and can be referenced in \*SECTION\_SOLID. Also, the 2 point pentahedron solid, type 15, no longer has a singular mode.
- The keyword \*SECTION\_ALE1D defines section properties for 1D ALE elements.
- The keyword \*SECTION\_ALE2D defines section properties for 2D ALE elements.
- The keywords \*SET\_BEAM\_INTERSECT, \*SET\_SHELL\_INTERSECT, \*SET\_SOLID\_INTERSECT, \*SET\_NODE\_INTERSECT, and \*SET\_SEGMENT\_INTERSECT, allows the definition of a set as the intersection,  $\cap$ , of a series of sets. The new set, SID, contains all common members.
- The keyword, \*SET\_SEGMENT\_ADD, is now available for defining a new segment set by combining other segment sets.
- The two keywords, \*DEFINE\_ELEMENT\_GENERALIZED\_SHELL and \*DEFINE\_ELEMENT\_GENERALIZED\_SOLID, are used to define general shell and solid element formulations to allow the rapid prototyping of new element formulations. They are used in combination with the new keywords \*ELEMENT\_GENERALIZED\_SHELL and \*ELEMENT\_GENERALIZED\_SOLID.
- The two keywords, \*ELEMENT\_INTERPOLATION\_SHELL and \*ELEMENT\_INTERPOLATION\_SOLID, are used to interpolate stresses and other solution variables from the generalized shell and solid element formulations for visualization. They are used together with the new keyword \*CONSTRAINED\_NODE\_INTERPOLATION.
- The keyword, \*ELEMENT\_SHELL\_NURBS\_PATCH, is used to define 3D shell elements based on NURBS (Non-Uniform Ration B-Spline) basis functions. Currently four different element formulations, with and without rotational degrees of freedom are available.

# INTRODUCTION

---

- The keyword `LOAD_SPCFORC` is used to apply equivalent SPC loads, read in from the `d3dump` file during a full-deck restart, in place of the original constraints in order to facilitate the classical non-reflecting boundary on an outside surface.

## MATERIAL MODELS

Some of the material models presently implemented are:

- elastic,
- orthotropic elastic,
- kinematic/isotropic plasticity [Krieg and Key 1976],
- thermoelastoplastic [Hallquist 1979],
- soil and crushable/non-crushable foam [Key 1974],
- linear viscoelastic [Key 1974],
- Blatz-Ko rubber [Key 1974],
- high explosive burn,
- hydrodynamic without deviatoric stresses,
- elastoplastic hydrodynamic,
- temperature dependent elastoplastic [Steinberg and Guinan 1978],
- isotropic elastoplastic,
- isotropic elastoplastic with failure,
- soil and crushable foam with failure,
- Johnson/Cook plasticity model [Johnson and Cook 1983],
- pseudo TENSOR geological model [Sackett 1987],
- elastoplastic with fracture,
- power law isotropic plasticity,
- strain rate dependent plasticity,
- rigid,
- thermal orthotropic,
- composite damage model [Chang and Chang 1987a 1987b],
- thermal orthotropic with 12 curves,
- piecewise linear isotropic plasticity,
- inviscid, two invariant geologic cap [Sandler and Rubin 1979, Simo et al, 1988a 1988b],
- orthotropic crushable model,
- Mooney-Rivlin rubber,
- resultant plasticity,
- force limited resultant formulation,
- closed form update shell plasticity,
- Frazer-Nash rubber model,
- laminated glass model,
- fabric,
- unified creep plasticity,
- temperature and rate dependent plasticity,
- elastic with viscosity,
- anisotropic plasticity,
- user defined,
- crushable cellular foams [Nielsen, Morgan, and Krieg 1987],
- urethane foam model with hysteresis,

and some more foam and rubber models, as well as many materials models for springs and dampers. The hydrodynamic material models determine only the deviatoric stresses. Pressure is determined by one of ten equations of state including:

# \*INTRODUCTION

---

- linear polynomial [Woodruff 1973],
- JWL high explosive [Dobratz 1981],
- Sack “Tuesday” high explosive [Woodruff 1973],
- Gruneisen [Woodruff 1973],
- ratio of polynomials [Woodruff 1973],
- linear polynomial with energy deposition,
- ignition and growth of reaction in HE [Lee and Tarver 1980, Cochran and Chan 1979],
- tabulated compaction,
- tabulated,
- TENSOR pore collapse [Burton et al. 1982].

The ignition and growth EOS was adapted from KOVEC [Woodruff 1973]; the other subroutines, programmed by the authors, are based in part on the cited references and are nearly 100 percent vectorized. The forms of the first five equations of state are also given in the KOVEC user’s manual and are retained in this manual. The high explosive programmed burn model is described by Giroux [Simo et al. 1988].

The orthotropic elastic and the rubber material subroutines use Green-St. Venant strains to compute second Piola-Kirchhoff stresses, which transform to Cauchy stresses. The Jaumann stress rate formulation is used with all other materials with the exception of one plasticity model which uses the Green-Naghdi rate.

## SPATIAL DISCRETIZATION

The elements shown in Figure 1.1 are presently available. Currently springs, dampers, beams, membranes, shells, bricks, thick shells and seatbelt elements are included.

The first shell element in DYNA3D was that of Hughes and Liu [Hughes and Liu 1981a, 1981b, 1981c], implemented as described in [Hallquist et al. 1985, Hallquist and Benson 1986]. This element [designated as HL] was selected from among a substantial body of shell element literature because the element formulation has several desirable qualities:

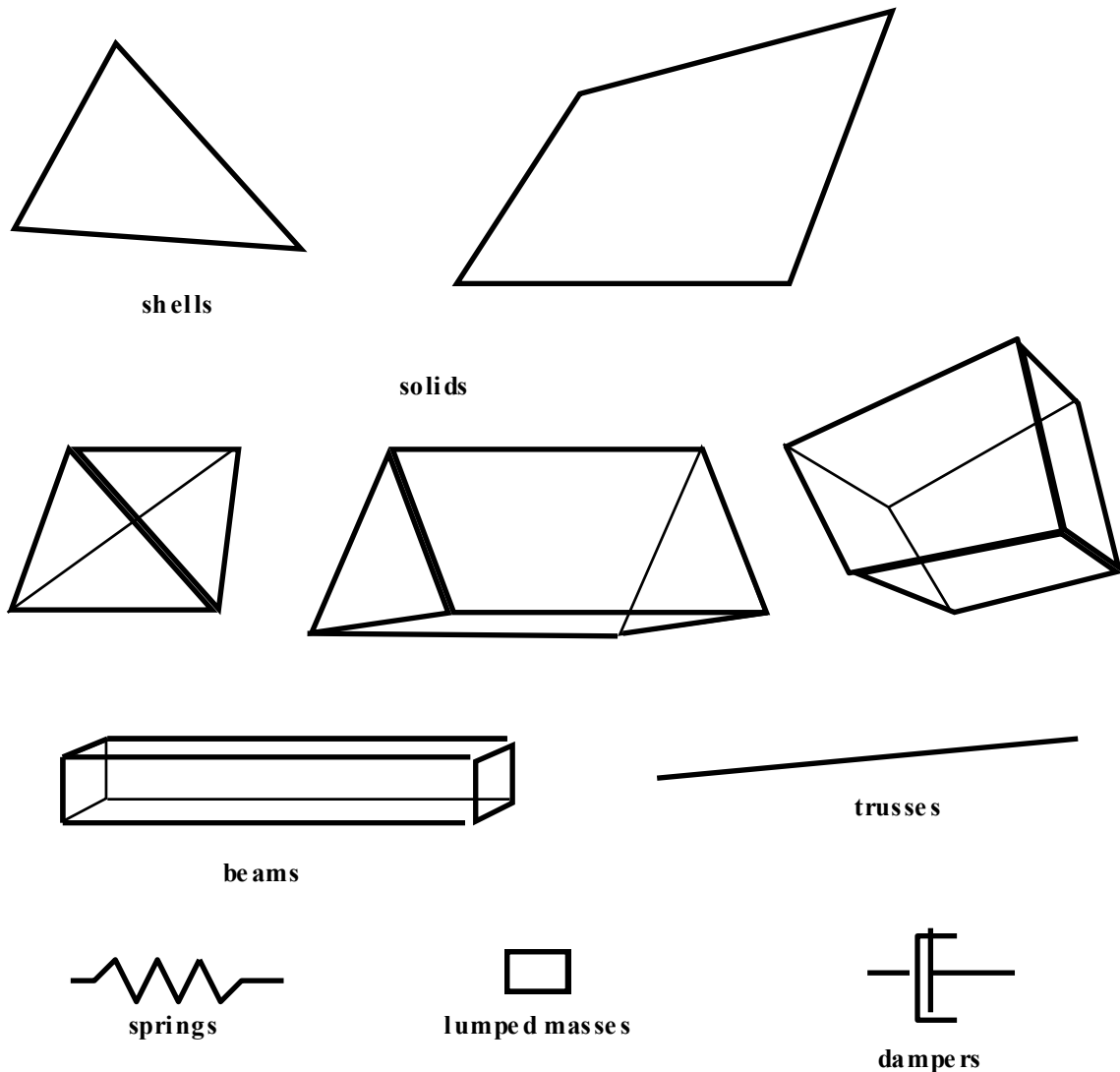
- It is incrementally objective (rigid body rotations do not generate strains), allowing for the treatment of finite strains that occur in many practical applications.
- It is compatible with brick elements, because the element is based on a degenerated brick element formulation. This compatibility allows many of the efficient and effective techniques developed for the DYNA3D brick elements to be used with this shell element;
- It includes finite transverse shear strains;
- A through-the-thickness thinning option (see [Hughes and Carnoy 1981]) is also available.

All shells in our current LS-DYNA code must satisfy these desirable traits to at least some extent to be useful in metalforming and crash simulations.

The major disadvantage of the HL element turned out to be cost related and, for this reason, within a year of its implementation we looked at the Belytschko-Tsay [BT] shell [Belytschko and Tsay 1981, 1983, 1984] as a more cost effective, but possibly less accurate alternative. In the BT shell the geometry of the shell is assumed to be perfectly flat, the local coordinate system originates at the first node of the connectivity, and the co-rotational stress update does not use the costly Jaumann stress rotation. With these and other simplifications, a very cost effective

# \*INTRODUCTION

shell was derived which today has become perhaps the most widely used shell elements in both metalforming and crash applications. Results generated by the BT shell usually compare favorably with those of the more costly HL shell. Triangular shell elements are implemented, based on work by Belytschko and co-workers [Belytschko and Marchertas 1974, Bazeley et al. 1965, Belytschko et al. 1984], and are frequently used since collapsed quadrilateral shell elements tend to lock and give very bad results. LS-DYNA automatically treats collapsed quadrilateral shell elements as  $C^0$  triangular elements.



**Figure 1.1.** Elements in LS-DYNA.

Three-dimensional plane stress constitutive subroutines are implemented for the shell elements which iteratively update the stress tensor such that the stress component normal to the shell midsurface is zero. An iterative update is necessary to accurately determine the normal strain component which is necessary to predict thinning. One constitutive evaluation is made for each integration point through the shell thickness.

# **\*INTRODUCTION**

---

## **CONTACT-IMPACT INTERFACES**

sliding only for fluid/structure or gas/structure interfaces,  
tied,  
sliding, impact, friction,  
single surface contact,  
discrete nodes impacting surface,  
discrete nodes tied to surface,  
shell edge tied to shell surface,  
nodes spot welded to surface,  
tiebreak interface,  
one way treatment of sliding, impact, friction,  
box/material limited automatic contact for shells,  
automatic contact for shells (no additional input required),  
automatic single surface with beams and arbitrary orientations,  
surface to surface eroding contact,  
node to surface eroding contact,  
single surface eroding contact,  
surface to surface symmetric constraint method [Taylor and Flanagan 1989],  
node to surface constraint method [Taylor and Flanagan 1989],  
rigid body to rigid body contact with arbitrary force/deflection curve,  
rigid nodes to rigid body contact with arbitrary force/deflection curve,  
edge-to-edge,  
draw beads.

## **INTERFACE DEFINITIONS FOR COMPONENT ANALYSIS**

Since the Belytschko-Tsay element is based on a perfectly flat geometry, warpage is not considered. Although this generally poses no major difficulties and provides for an efficient element, incorrect results in the twisted beam problem and similar situations are obtained where the nodal points of the elements used in the discretization are not coplanar. The Hughes-Liu shell element considers non-planar geometries and gives good results on the twisted beam. The effect of neglecting warpage in a typical application cannot be predicted beforehand and may lead to less than accurate results, but the latter is only speculation and is difficult to verify in practice. Obviously, it would be better to use shells that consider warpage if the added costs are reasonable and if this unknown effect is eliminated. Another shell published by Belytschko, Wong, and Chiang [Belytschko, Wong, and Chiang 1989, 1992] proposes inexpensive modifications to include the warping stiffness in the Belytschko-Tsay shell. An improved transverse shear treatment also allows the element to pass the Kirchhoff patch test. This element is now available in LS-DYNA. Also, two fully integrated shell elements, based on the Hughes and Liu formulation, are available in LS-DYNA, but are rather expensive. A much faster fully integrated element which is essentially a fully integrated version of the Belytschko, Wong, and Chiang element, type 16, is a more recent addition and is recommended if fully integrated elements are needed due to its cost effectiveness.

Zero energy modes in the shell and solid elements are controlled by either an hourglass viscosity or stiffness. Eight node thick shell elements are implemented and have been found to perform



## \*INTRODUCTION

---

well in many applications. All elements are nearly 100% vectorized. All element classes can be included as parts of a rigid body. The rigid body formulation is documented in [Benson and Hallquist 1986]. Rigid body point nodes, as well as concentrated masses, springs and dashpots can be added to this rigid body.

Membrane elements can be either defined directly as shell elements with a membrane formulation option or as shell elements with only one point for through thickness integration. The latter choice includes transverse shear stiffness and may be inappropriate. For airbag material a special fully integrated three and four node membrane element is available.

Two different beam types are available: a stress resultant beam and a beam with cross section integration at one point along the axis. The cross section integration allows for a more general definition of arbitrarily shaped cross sections taking into account material nonlinearities.

Spring and damper elements can be translational or rotational. Many behavior options can be defined, e.g., arbitrary nonlinear behavior including locking and separation.

Solid elements in LS-DYNA may be defined using from 4 to 8 nodes. The standard elements are based on linear shape functions and use one point integration and hourglass control. A selective-reduced integrated (called fully integrated) 8 node solid element is available for situations when the hourglass control fails. Also, two additional solid elements, a 4 noded tetrahedron and an 8 noded hexahedron, with nodal rotational degrees of freedom, are implemented based on the idea of Allman [1984] to replace the nodal midside translational degrees of freedom of the elements with quadratic shape functions by corresponding nodal rotations at the corner nodes. The latter elements, which do not need hourglass control, require many numerical operations compared to the hourglass controlled elements and should be used at places where the hourglass elements fail. However, it is well known that the elements using more than one point integration are more sensitive to large distortions than one point integrated elements.

The thick shell element is a shell element with only nodal translations for the eight nodes. The assumptions of shell theory are included in a non-standard fashion. It also uses hourglass control or selective-reduced integration. This element can be used in place of any four node shell element. It is favorably used for shell-brick transitions, as no additional constraint conditions are necessary. However, care has to be taken to know in which direction the shell assumptions are made; therefore, the numbering of the element is important.

Seatbelt elements can be separately defined to model seatbelt actions combined with dummy models. Separate definitions of seatbelts, which are one-dimensional elements, with accelerometers, sensors, pretensioners, retractors, and slippers are possible. The actions of the various seatbelt definitions can also be arbitrarily combined.

The three-dimensional contact-impact algorithm was originally an extension of the NIKE2D [Hallquist 1979] two-dimensional algorithm. As currently implemented, one surface of the interface is identified as a master surface and the other as a slave. Each surface is defined by a set of three or four node quadrilateral segments, called master and slave segments, on which the nodes of the slave and master surfaces, respectively, must slide. In general, an input for the contact-impact algorithm requires that a list of master and slave segments be defined. For the single surface algorithm only the slave surface is defined and each node in the surface is checked each time step to ensure that it does not penetrate through the surface. Internal logic [Hallquist

## **\*INTRODUCTION**

---

1977, Hallquist et al. 1985] identifies a master segment for each slave node and a slave segment for each master node and updates this information every time step as the slave and master nodes slide along their respective surfaces. It must be noted that for general automatic definitions only parts/materials or three-dimensional boxes have to be given. Then the possible contacting outer surfaces are identified by the internal logic in LS-DYNA. More than 20 types of interfaces can presently be defined including:

Interface friction can be used with most interface types. The tied and sliding only interface options are similar to the two-dimensional algorithm used in LS-DYNA2D [Hallquist 1976, 1978, 1980]. Unlike the general option, the tied treatments are not symmetric; therefore, the surface which is more coarsely zoned should be chosen as the master surface. When using the one-way slide surface with rigid materials, the rigid material should be chosen as the master surface.

For geometric contact entities, contact has to be separately defined. It must be noted that for the contact of a rigid body with a flexible body, either the sliding interface definitions as explained above or the geometric contact entity contact can be used. Currently, the geometric contact entity definition is recommended for metalforming problems due to high accuracy and computational efficiency.

Interface definitions for component analyses are used to define surfaces, nodal lines, or nodal points (\*INTERFACE\_COMPONENTS) for which the displacement and velocity time histories are saved at some user specified frequency (\*CONTROL\_OUTPUT). This data may then used to drive interfaces (\*INTERFACE\_LINKING) in subsequent analyses. This capability is especially useful for studying the detailed response of a small member in a large structure. For the first analysis, the member of interest need only be discretized sufficiently that the displacements and velocities on its boundaries are reasonably accurate. After the first analysis is completed, the member can be finely discretized and interfaces defined to correspond with the first analysis. Finally, the second analysis is performed to obtain highly detailed information in the local region of interest.

When starting the analysis, specify a name for the interface segment file using the Z = parameter on the LS-DYNA command line. When starting the second analysis, the name of the interface segment file (created in the first run) should be specified using the L = parameter on the LS-DYNA command line.

Following the above procedure, multiple levels of sub-modeling are easily accommodated. The interface file may contain a multitude of interface definitions so that a single run of a full model can provide enough interface data for many component analyses. The interface feature represents a powerful extension of LS-DYNA's analysis capability.

## **MODEL SIZING**

Storage allocation is dynamic. The only limit that exists on the number of boundary condition cards, number of material cards, number of pressure cards, etc., is the capacity of the computer. Typical LS-DYNA calculations may have 10,000 to 500,000 elements. Memory allocation is dynamic and can be controlled during execution.

## PRECISION

The explicit time integration algorithms used in LS-DYNA are in general much less sensitive to machine precision than other finite element solution methods. Consequently, double precision is not used. The benefits of this are greatly improved utilization of memory and disk. When problems have been found we have usually been able to overcome them by reorganizing the algorithm or by converting to double precision locally in the subroutine where the problem occurs. A few of the known problems include: **(32-bit computers only!)**:

- Round-off errors can cause difficulties with extremely small deflection problems. (Maximum vibration amplitudes are  $<10^{-6}$  times nodal coordinates).
- Workaround: Increase the load.
- Buckling problems, which are very sensitive to small imperfections.

However, the users of LS-DYNA have to be aware of potential problems.

A major reorganization of LS-DYNA has led to a version using double precision throughout the full program. As memory and disk space of the computer is less of a problem, we prefer to provide this version for all machines. It also allows LS-DYNA to take advantage of the 64-bit technology offered by many computer manufacturers.



# GETTING STARTED

## DESCRIPTION OF KEYWORD INPUT

The keyword input provides a flexible and logically organized database that is simple to understand. Similar functions are grouped together under the same keyword. For example, under the keyword \*ELEMENT are included solid, beam, shell elements, spring elements, discrete dampers, seat belts, and lumped masses. Many keywords have options that are identified as follows: "OPTIONS" and "{OPTIONS}". The difference is that "OPTIONS" requires that one of the options must be selected to complete the keyword command. The option <BLANK> is included when {} are used to further indicate that these particular options are not necessary to complete the keyword.

LS-DYNA User's Manual is alphabetically organized in logical sections of input data. Each logical section relates to a particular input. There is a control section for resetting LS-DYNA defaults, a material section for defining constitutive constants, an equation-of-state section, an element section where element part identifiers and nodal connectivities are defined, a section for defining parts, and so on. Nearly all model data can be input in block form. For example, consider the following where two nodal points with their respective coordinates and shell elements with their part identity and nodal connectivities are defined:

```
$      DEFINE TWO NODES
$
*NODE
    10101      x      y      z
    10201      x      y      z
$      DEFINE TWO SHELL ELEMENTS
$
*ELEMENT_SHELL
    10201      pid    n1    n2    n3    n4
    10301      pid    n1    n2    n3    n4
```

Alternatively, acceptable input could also be of the form:

```
$      DEFINE ONE NODE
$
*NODE
    10101      x      y      z
$      DEFINE ONE SHELL ELEMENT
$
*ELEMENT_SHELL
    10201      pid    n1    n2    n3    n4

$      DEFINE ONE MORE NODE
$
*NODE
    10201      x      y      z
```

# GETTING STARTED

---

```
$      DEFINE ONE MORE SHELL ELEMENT
$
*ELEMENT_SHELL
      10301      pid      n1      n2      n3      n4
```

A data block begins with a keyword followed by the data pertaining to the keyword. The next keyword encountered during the reading of the block data defines the end of the block and the beginning of a new block. A keyword must be left justified with the “\*” contained in column one. A dollar sign “\$” in column one precedes a comment and causes the input line to be ignored. Data blocks are not a requirement for LS-DYNA but they can be used to group nodes and elements for user convenience. Multiple blocks can be defined with each keyword if desired as shown above. It would be possible to put all nodal points definitions under one keyword \*NODE, or to define one \*NODE keyword prior to each node definition. The entire LS-DYNA input is order independent with the exception of the optional keyword, \*END, which defines the end of input stream. Without the \*END termination is assumed to occur when an end-of-file is encountered during the reading.

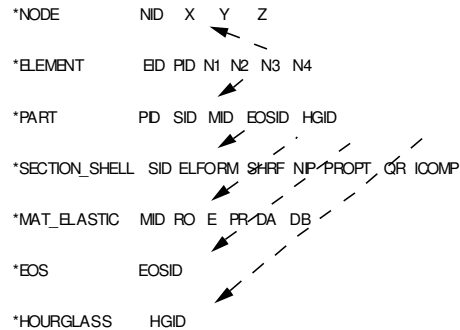
Figure 2.1 attempts to show the general philosophy of the input organization and how various entities relate to each other. In this figure the data included for the keyword, \*ELEMENT, is the element identifier, EID, the part identifier, PID, and the nodal points identifiers, the NID’s, defining the element connectivity: N1, N2, N3, and N4. The nodal point identifiers are defined in the \*NODE section where each NID should be defined just once. A part defined with the \*PART keyword has a unique part identifier, PID, a section identifier, SID, a material or constitutive model identifier, MID, an equation of state identifier, EOSID, and the hourglass control identifier, HGID. The \*SECTION keyword defines the section identifier, SID, where a section has an element formulation specified, a shear factor, SHRF, a numerical integration rule, NIP, and so on. The constitutive constants are defined in the \*MAT section where constitutive data is defined for all element types including solids, beams, shells, thick shells, seat belts, springs, and dampers. Equations of state, which are used only with certain \*MAT materials for solid elements, are defined in the \*EOS section. Since many elements in LS-DYNA use uniformly reduced numerical integration, zero energy deformation modes may develop. These modes are controlled numerically by either an artificial stiffness or viscosity which resists the formation of these undesirable modes. The hourglass control can optionally be user specified using the input in the \*HOURGLASS section.

During the keyword input phase where data is read, only limited checking is performed on the data since the data must first be counted for the array allocations and then reordered. Considerably more checking is done during the second phase where the input data is printed out. Since LS-DYNA has retained the option of reading older non-keyword input files, we print out the data into the output file D3HSP (default name) as in previous versions of LS-DYNA. An attempt is made to complete the input phase before error terminating if errors are encountered in the input. Unfortunately, this is not always possible and the code may terminate with an error message. The user should always check either output file, D3HSP or MESSAG, for the word “Error”.

The input data following each keyword can be input in free format. In the case of free format input the data is separated by commas, i.e.,

```
*NODE
10101,x ,y ,z
10201,x ,y ,z
```

```
*ELEMENT_SHELL
10201,pid,n1,n2,n3,n4
10301,pid,n1,n2,n3,n4
```



**Figure 2.1.** Organization of the keyword input.

When using commas, the formats **must not** be violated. An I8 integer is limited to a maximum positive value of 99999999, and larger numbers having more than eight characters are unacceptable. The format of the input can change from free to fixed anywhere in the input file. The input is case insensitive and keywords can be given in either upper or lower case. THE ASTERISKS “\*” PRECEDING EACH KEYWORD MUST BE IN COLUMN ONE.

To provide a better understanding behind the keyword philosophy and how the options work, a brief review the keywords is given below.

## **\*AIRBAG**

The geometric definition of airbags and the thermodynamic properties for the airbag inflator models can be made in this section. This capability is not necessarily limited to the modeling of automotive airbags, but it can also be used for many other applications such as tires and pneumatic dampers.

## **\*ALE**

This keyword provides a way of defining input data pertaining to the Arbitrary-Lagrangian-Eulerian capability.

## **\*BOUNDARY**

This section applies to various methods of specifying either fixed or prescribed boundary conditions. For compatibility with older versions of LS-DYNA it is still possible to specify some nodal boundary conditions in the \*NODE card section.

## **\*CASE**

This keyword option provides a way of running multiple load cases sequentially. Within each case, the input parameters, which include loads, boundary conditions, control cards, contact definitions, initial conditions, etc., can change. If desired, the results from a previous case can be

# GETTING STARTED

---

used during initialization. Each case creates unique file names for all output results files by appending “CIDn.” to the default file name.

## **\*COMPONENT**

This section contains analytical rigid body dummies that can be placed within vehicle and integrated implicitly.

## **\*CONSTRAINED**

This section applies constraints within the structure between structural parts. For example, nodal rigid bodies, rivets, spot welds, linear constraints, tying a shell edge to a shell edge with failure, merging rigid bodies, adding extra nodes to rigid bodies and defining rigid body joints are all options in this section.

## **\*CONTACT**

This section is divided in to three main sections. The \*CONTACT section allows the user to define many different contact types. These contact options are primarily for treating contact of deformable to deformable bodies, single surface contact in deformable bodies, deformable body to rigid body contact, and tying deformable structures with an option to release the tie based on plastic strain. The surface definition for contact is made up of segments on the shell or solid element surfaces. The keyword options and the corresponding numbers in previous code versions are:

<u>STRUCTURED INPUT TYPE ID</u>	<u>KEYWORD NAME</u>
1	SLIDING_ONLY
p 1	SLIDING_ONLY_PENALTY
2	TIED_SURFACE_TO_SURFACE
3	SURFACE_TO_SURFACE
a 3	AUTOMATIC_SURFACE_TO_SURFACE
4	SINGLE_SURFACE
5	NODES_TO_SURFACE
a 5	AUTOMATIC_NODES_TO_SURFACE
6	TIED_NODES_TO_SURFACE
7	TIED_SHELL_EDGE_TO_SURFACE
8	TIEBREAK_NODES_TO_SURFACE
9	TIEBREAK_SURFACE_TO_SURFACE
10	ONE_WAY_SURFACE_TO_SURFACE
a 10	AUTOMATIC_ONE_WAY_SURFACE_TO_SURFACE
13	AUTOMATIC_SINGLE_SURFACE
a 13	AIRBAG_SINGLE_SURFACE
14	ERODING_SURFACE_TO_SURFACE
15	ERODING_SINGLE_SURFACE
16	ERODING_NODES_TO_SURFACE
17	CONSTRAINT_SURFACE_TO_SURFACE



# GETTING STARTED

---

<u>STRUCTURED INPUT TYPE ID</u>	<u>KEYWORD NAME</u>
18	CONSTRAINT_NODES_TO_SURFACE
19	RIGID_BODY_TWO_WAY_TO_RIGID_BODY
20	RIGID_NODES_TO_RIGID_BODY
21	RIGID_BODY_ONE_WAY_TO_RIGID_BODY
22	SINGLE_EDGE
23	DRAWBEAD

The \*CONTACT\_ENTITY section treats contact between a rigid surface, usually defined as an analytical surface, and a deformable structure. Applications of this type of contact exist in the metal forming area where the punch and die surface geometries can be input as VDA surfaces which are treated as rigid. Another application is treating contact between rigid body occupant dummy hyper-ellipsoids and deformable structures such as airbags and instrument panels. This option is particularly valuable in coupling with the rigid body occupant modeling codes MADYMO and CAL3D. The \*CONTACT\_1D is for modeling rebars in concrete structure.

## **\*CONTROL**

Options available in the \*CONTROL section allow the resetting of default global parameters such as the hourglass type, the contact penalty scale factor, shell element formulation, numerical damping, and termination time.

## **\*DAMPING**

Defines damping either globally or by part identifier.

## **\*DATABASE**

This keyword with a combination of options can be used for controlling the output of ASCII databases and binary files output by LS-DYNA. With this keyword the frequency of writing the various databases can be determined.

## **\*DEFINE**

This section allows the user to define curves for loading, constitutive behaviors, etc.; boxes to limit the geometric extent of certain inputs; local coordinate systems; vectors; and orientation vectors specific to spring and damper elements. Items defined in this section are referenced by their identifiers throughout the input. For example, a coordinate system identifier is sometimes used on the \*BOUNDARY cards, and load curves are used on the \*AIRBAG cards.

## **\*DEFORMABLE\_TO\_RIGID**

This section allows the user to switch parts that are defined as deformable to rigid at the start of the analysis. This capability provides a cost efficient method for simulating events such as rollover events. While the vehicle is rotating the computation cost can be reduced significantly by switching deformable parts that are not expected to deform to rigid parts. Just before the vehicle comes in contact with ground, the analysis can be stopped and restarted with the part switched back to deformable.

# GETTING STARTED

---

## **\*EF**

Exchange factors characterize radiative heat transfer between collections of flat surfaces, the union of which is a closed surface (an enclosure). LS-DYNA can calculate exchange factors and then use them as boundary conditions for thermal runs. The  $(i,j)^{\text{th}}$  element of an exchange factor matrix,  $E_{ij}$ , is the fraction of the Stefan-Boltzman surface energy radiated from surface  $i$  that is absorbed by surface  $j$ . LS-DYNA employs a Monte Carlo algorithm to calculate these exchange factors. For each surface, LS-DYNA simulates photon emission one photon at a time. For each photon, LS-DYNA generates a random initial position on the emitting surfaces as well as a random initial direction that points into the enclosure. LS-DYNA ray traces each photon until it is absorbed. The path of a simulated photon can be complex involving multiple diffuse and specular reflections as well as multiple diffuse and specular transmissions. The results of this Monte Carlo algorithm are used to assemble a matrix that is related to the exchange factor matrix, for which, the  $(i,j)^{\text{th}}$  entry contains the number of photons emitted from surface  $i$  that are absorbed by surface  $j$ . From this matrix LS-DYNA then assembles the exchange factor matrix.

## **\*ELEMENT**

Define identifiers and connectivities for all elements which include shells, beams, solids, thick shells, springs, dampers, seat belts, and concentrated masses in LS-DYNA.

## **\*EOS**

This section reads the equations of state parameters. The equation of state identifier, EOSID, points to the equation of state identifier on the \*PART card.

## **\*HOURLASS**

Defines hourglass and bulk viscosity properties. The identifier, HGID, on the \*HOURLASS card refers to HGID on \*PART card.

## **\*INCLUDE**

To make the input file easy to maintain, this keyword allows the input file to be split into subfiles. Each subfile can again be split into sub-subfiles and so on. This option is beneficial when the input data deck is very large.

## **\*INITIAL**

Initial velocity and initial momentum for the structure can be specified in this section. The initial velocity specification can be made by \*INITIAL\_VELOCITY\_NODE card or \*INITIAL\_VELOCITY cards. In the case of \*INITIAL\_VELOCITY\_NODE nodal identifiers are used to specify the velocity components for the node. Since all the nodes in the system are initialized to zero, only the nodes with non-zero velocities need to be specified. The \*INITIAL\_VELOCITY card provides the capability of being able to specify velocities using the set concept or boxes.

## **\*INTEGRATION**

In this section the user defined integration rules for beam and shell elements are specified. IRID refers to integration rule number IRID on \*SECTION\_BEAM and \*SECTION\_SHELL cards respectively. Quadrature rules in the \*SECTION\_SHELL and \*SECTION\_BEAM cards need to be specified as a negative number. The absolute value of the negative number refers to user defined integration rule number. Positive rule numbers refer to the built in quadrature rules within LS-DYNA.

## **\*INTERFACE**

Interface definitions are used to define surfaces, nodal lines, and nodal points for which the displacement and velocity time histories are saved at some user specified frequency. This data may then be used in subsequent analyses as an interface ID in the \*INTERFACE\_LINKING\_DISCRETE\_NODE as master nodes, in \*INTERFACE\_LINKING\_SEGMENT as master segments and in \*INTERFACE\_LINKING\_EDGE as the master edge for a series of nodes. This capability is especially useful for studying the detailed response of a small member in a large structure. For the first analysis, the member of interest need only be discretized sufficiently that the displacements and velocities on its boundaries are reasonably accurate. After the first analysis is completed, the member can be finely discretized in the region bounded by the interfaces. Finally, the second analysis is performed to obtain highly detailed information in the local region of interest. When beginning the first analysis, specify a name for the interface segment file using the Z=parameter on the LS-DYNA execution line. When starting the second analysis, the name of the interface segment file created in the first run should be specified using the L=parameter on the LS-DYNA command line. Following the above procedure, multiple levels of sub-modeling are easily accommodated. The interface file may contain a multitude of interface definitions so that a single run of a full model can provide enough interface data for many component analyses. The interface feature represents a powerful extension of LS-DYNA's analysis capabilities. A similar capability using \*INTERFACE\_SSI may be used for soil-structure interaction analysis under earthquake excitation.

## **\*KEYWORD**

Flags LS-DYNA that the input deck is a keyword deck. To have an effect this must be the very first card in the input deck. Alternatively, by typing "keyword" on the execute line, keyword input formats are assumed and the "\*KEYWORD" is not required. If a number is specified on this card after the word KEYWORD it defines the memory size to be used in words. The memory size can also be set on the command line. NOTE THAT THE MEMORY SPECIFIED ON THE EXECUTION LINE OVERRIDES MEMORY SPECIFIED ON THE \*KEYWORD CARD.

## **\*LOAD**

This section provides various methods of loading the structure with concentrated point loads, distributed pressures, body force loads, and a variety of thermal loadings.

## **\*MAT**

This section allows the definition of constitutive constants for all material models available in LS-DYNA including springs, dampers, and seat belts. The material identifier, MID, points to the MID on the \*PART card.

## **\*NODE**

Define nodal point identifiers and their coordinates.

## **\*PARAMETER**

This option provides a way of specifying numerical values of parameter names that are referenced throughout the input file. The parameter definitions, if used, should be placed at the beginning of the input file following \*KEYWORD. \*PARAMETER\_EXPRESSION permits general algebraic expressions to be used to set the values.

# GETTING STARTED

---

## **\*PART**

This keyword serves two purposes.

1. Relates part ID to \*SECTION, \*MATERIAL, \*EOS and \*HOURLASS sections.
2. Optionally, in the case of a rigid material, rigid body inertia properties and initial conditions can be specified. Deformable material repositioning data can also be specified in this section if the reposition option is invoked on the \*PART card, i.e., \*PART\_REPOSITION.

## **\*PERTURBATION**

This keyword provides a way of defining deviations from the designed structure such as, buckling imperfections.

## **\*RAIL**

This keyword provides a way of defining a wheel-rail contact algorithm intended for railway applications but can also be used for other purposes. The wheel nodes (defined on \*RAIL\_TRAIN) represent the contact patch between wheel and rail.

## **\*RIGIDWALL**

Rigid wall definitions have been divided into two separate sections, \_PLANAR and \_GEOMETRIC. Planar walls can be either stationary or moving in translational motion with mass and initial velocity. The planar wall can be either finite or infinite. Geometric walls can be planar as well as have the geometric shapes such as rectangular prism, cylindrical prism and sphere. By default, these walls are stationary unless the option MOTION is invoked for either prescribed translational velocity or displacement. Unlike the planar walls, the motion of the geometric wall is governed by a load curve. Multiple geometric walls can be defined to model combinations of geometric shapes available. For example, a wall defined with the \_CYLINDER option can be combined with two walls defined with the \_SPHERICAL option to model hemispherical surface caps on the two ends of a cylinder. Contact entities are also analytical surfaces but have the significant advantage that the motion can be influenced by the contact to other bodies, or prescribed with six full degrees-of-freedom.

## **\*SECTION**

In this section, the element formulation, integration rule, nodal thicknesses, and cross sectional properties are defined. All section identifiers (SECID's) defined in this section must be unique, i.e., if a number is used as a section ID for a beam element then this number cannot be used again as a section ID for a solid element.

## **\*SENSOR**

This keyword provides a convenient way of activating and deactivating boundary conditions, airbags, discrete elements, joints, contact, rigid walls, single point constraints, and constrained nodes. The sensor capability is new in the second release of version 971 and will evolve in later releases to encompass many more LS-DYNA capabilities and replace some of the existing capabilities such as the airbag sensor logic.

## **\*SET**

A concept of grouping nodes, elements, materials, etc., in sets is employed throughout the LS-DYNA input deck. Sets of data entities can be used for output. So-called slave nodes used in contact definitions, slaves segment sets, master segment sets, pressure segment sets and so on can also be defined. The keyword, \*SET, can be defined in two ways:

1. Option `_LIST` requires a list of entities, eight entities per card, and define as many cards as needed to define all the entities.
2. Option `_COLUMN`, where applicable, requires an input of one entity per line along with up to four attribute values which are needed to specify, for example, failure criterion input that is needed for `*CONTACT_CONSTRAINT_NODES_TO_SURFACE` .

## **\*TERMINATION**

This keyword provides an alternative way of stopping the calculation before the termination time is reached. The termination time is specified on the `*CONTROL_TERMINATION` input and will terminate the calculation whether or not the options available in this section are active.

## **\*TITLE**

In this section a title for the analysis is defined.

## **\*USER\_INTERFACE**

This section provides a method to provide user control of some aspects of the contact algorithms including friction coefficients via user defined subroutines.

## **RESTART**

This section of the input is intended to allow the user to restart the simulation by providing a restart file and optionally a restart input defining changes to the model such as deleting contacts, materials, elements, switching materials from rigid to deformable, deformable to rigid, etc.

## **\*RIGID\_TO\_DEFORMABLE**

This section switches rigid parts back to deformable in a restart to continue the event of a vehicle impacting the ground which may have been modeled with a rigid wall.

## **\*STRESS\_INITIALIZATION**

This is an option available for restart runs. In some cases there may be a need for the user to add contacts, elements, etc., which are not available options for standard restart runs. A full input containing the additions is needed if this option is invoked upon restart.

# GETTING STARTED

## SUMMARY OF COMMONLY USED OPTIONS

The following table gives a list of the commonly used keywords related by topic.

Topic	Component	Keyword	
Geometry	Nodes	*NODE	
	Elements	*ELEMENT_BEAM	
		*ELEMENT_SHELL	
		*ELEMENT_SOLID	
		*ELEMENT_TSHELL	
	Discrete Elements	*ELEMENT_DISCRETE *ELEMENT_MASS *ELEMENT_SEATBELT_Option	
Materials	Part (which is composed of Material and Section, equation of state and hourglass data)	*PART	
	Material Sections	*MAT_Option *SECTION_BEAM *SECTION_SHELL *SECTION_SOLID *SECTION_TSHELL	
		Discrete sections	*SECTION_DISCRETE *SECTION_SEATBELT
		Equation of state	*EOS_Option
		Hourglass	*CONTROL_HOURLASS *HOURLASS
	Contacts and Rigid walls	Defaults for contacts	*CONTROL_CONTACT
		Definition of contacts	*CONTACT_Option
		Definition of rigid walls	*RIGIDWALL_Option
Boundary Conditions & Loadings	Restraints	*NODE *BOUNDARY_SPC_Option	
	Gravity (body) load	*LOAD_BODY_Option	
		Point load	*LOAD_NODE_Option
		Pressure load	*LOAD_SEGMENT_Option *LOAD_SHELL_Option
	Thermal load	*LOAD_THERMAL_Option	
	Load curves	*DEFINE_CURVE	
Constraints and spot welds	Constrained nodes	*CONSTRAINED_NODE_SET	
	Welds	*CONSTRAINED_GENERALIZED_WELD_Option *CONSTRAINED_SPOT_WELD	
		Rivet	*CONSTRAINED_RIVET

# GETTING STARTED

Topic	Component	Keyword
Output Control	Defaults	*CONTROL_OUTPUT
	ASCII time history files	*DATABASE_Option
	Binary plot, time history and restart files	*DATABASE_BINARY_Option
	Items in time history blocks	*DATABASE_HISTORY_Option
	Nodes for nodal reaction output	*DATABASE_NODAL_FORCE_GROUP
Termination	Termination time	*CONTROL_TERMINATION
	Termination cycle	*CONTROL_TERMINATION
	CPU termination	*CONTROL_CPU
	Degree of freedom	*TERMINATION_NODE

**Table GS.1.** Keywords for the most commonly used options.

## EXECUTION SYNTAX

The interactive execution line for LS-DYNA is as follows:

```
LS-DYNA I=inf O=otf G=ptf D=dpf F=thf U=xtf T=tpf A=rrd M=sif J=jif S=iff Z=isf1  
L=isf2 B=rlf W=root E=efl X=scl C=cpu K=kill V=vda Y=c3d BEM=bof {KEYWORD}  
{THERMAL} {COUPLE} {INIT} MEMORY=nwds NCPU=ncpu PARA=para  
ENDTIME=time NCYCLE=ncycle JOBID=jobid D3PROP=d3prop GMINP=gminp  
GMOUT=gmout
```

where

- inf** = input file (user specified)
- otf** = high speed printer file (default=D3HSP)
- ptf** = binary plot file for graphics (default=D3PLOT)
- dpf** = dump file for restarting (default=D3DUMP). This file is written at the end of every run and during the run as requested in the input. To stop the generation of this file set the file name to NODUMP.
- thf** = binary plot file for time histories of selected data (default=D3THDT)
- xtf** = binary plot file for time extra data (default-XTFIL)
- tpf** = optional temperature file
- rrd** = running restart dump file (default=RUNRSF)
- sif** = stress initialization file (user specified)
- jif** = optional JOY interface file
- iff** = interface force file (user specified)
- isf1** = interface segment save file to be created (user specified)
- isf2** = existing interface segment save file to be used (user specified)
- rlf** = binary plot file for dynamic relaxation (default=D3DRFL)
- efl** = echo file containing optional input echo with or without node/element data

# GETTING STARTED

---

- root** = root file name for general print option
- scl** = scale factor for binary file sizes (default=7)
- cpu** = cumulative cpu time limit in seconds for the entire simulation, including all restarts, if **cpu** is positive. If **cpu** is negative, the absolute value of **cpu** is the cpu time limit in seconds for the first run and for each subsequent restart run.
- kill** = if LS-DYNA encounters this file name it will terminate with a restart file (default=D3KIL)
- vda** = VDA/IGES database for geometrical surfaces
- c3d** = CAL3D input file
- bof** = \*BOUNDARY\_ELEMENT\_METHOD\_ACOUSTIC output file
- nwds** = Number of words to be allocated. On engineering workstations a word is usually 32bits. **This number overwrites the memory size specified on the \*KEYWORD card at the beginning of the input deck.**
- ncpu** = Overrides **NCPU** and **CONST** defined in \*CONTROL\_PARALLEL. A positive value sets CONST=2 and a negative values sets CONST=1. See the \*CONTROL\_PARALLEL command for an explanation of these parameters. The \*KEYWORD command provides an alternative way to set the number of CPUs.
- para** = Overrides **PARA** defined in \*CONTROL\_PARALLEL.
- time** = Overrides **ENDTIM** defined in \*CONTROL\_TERMINATION.
- ncycle** = Overrides **ENDCYC** defined in \*CONTROL\_TERMINATION.
- jobid** = Character string which acts as a prefix for all output files. Maximum length is 72 characters. **Do not** include the following characters: ) (\* / ? \.
- d3prop** = See \*DATABASE\_BINARY\_D3PROP input parameter IFILE for options.
- gminp** = Input file for reading recorded motions in \*INTERFACE\_SSI (default=GMBIN).
- gmout** = Output file for writing recorded motions in \*INTERFACE\_SSI\_AUX (default=GMBIN).

In order to avoid undesirable or confusing results, each LS-DYNA run should be performed in a separate directory, unless using the command line parameter “jobid” described above. If rerunning a job in the same directory, old files should first be removed or renamed to avoid confusion since the possibility exists that the binary database may contain results from both the old and new run.

By including **KEYWORD** anywhere on the execute line or instead if **\*KEYWORD** is the first card in the input file, the keyword formats are expected; otherwise, the older structured input file will be expected.

To run a coupled thermal analysis the command **COUPLE** must be in the execute line. A thermal only analysis may be run by including the word **THERMAL** in the execution line.

The **INIT** (or **sw1**. can be used instead) command on the execution line causes the calculation to run just one cycle followed by termination with a full restart file. No editing of the input deck is required. The calculation can then be restarted with or without any additional input. Sometimes this option can be used to reduce the memory on restart if the required memory is given on the execution line and is specified too large in the beginning when the amount of required memory is unknown. Generally, this option would be used at the beginning of a new calculation.



# GETTING STARTED

---

If the word **MEMORY** is found anywhere on the execution line and if it is not set via (**=nwds**) LS-DYNA will give the default size of memory, request, and then read in the desired memory size. This option is necessary if the default value is insufficient memory and termination occurs as a result. Occasionally, the default value is too large for execution and this option can be used to lower the default size. Memory can also be specified on the **\*KEYWORD** card.

## SENSE SWITCH CONTROLS

The status of an in-progress LS-DYNA simulation can be determined by using the sense switch. On UNIX versions, this is accomplished by first typing a “^C” (Control-C). This sends an interrupt to LS-DYNA which is trapped and the user is prompted to input the sense switch code. LS-DYNA has nine terminal sense switch controls that are tabulated below:

<u>Type</u>	<u>Response</u>
<b>SW1.</b>	A restart file is written and LS-DYNA terminates.
<b>SW2.</b>	LS-DYNA responds with time and cycle numbers.
<b>SW3.</b>	A restart file is written and LS-DYNA continues.
<b>SW4.</b>	A plot state is written and LS-DYNA continues.
<b>SW5.</b>	Enter interactive graphics phase and real time visualization.
<b>SW7.</b>	Turn off real time visualization.
<b>SW8.</b>	Interactive 2D rezoner for solid elements and real time visualization.
<b>SW9.</b>	Turn off real time visualization (for option SW8).
<b>SWA.</b>	Flush ASCII file buffers.
<b>lprint</b>	Enable/Disable printing of equation solver memory, cpu requirements.
<b>nlprint</b>	Enable/Disable printing of nonlinear equilibrium iteration information.
<b>iter</b>	Enable/Disable output of binary plot database "d3iter" showing mesh after each equilibrium iteration. Useful for debugging convergence problems.
<b>conv</b>	Temporarily override nonlinear convergence tolerances.
<b>stop</b>	Halt execution immediately, closing open files.

On UNIX/LINUX systems the sense switches can still be used if the job is running in the background or in batch mode. To interrupt LS-DYNA simply create a file called D3KIL containing the desired sense switch, e.g., "sw1." LS-DYNA periodically looks for this file and if found, the sense switch contained therein is invoked and the D3KIL file is deleted. A null D3KIL file is equivalent to a "sw1."

When LS-DYNA terminates, all scratch files are destroyed: the restart file, plot files, and high-speed printer files remain on disk. Of these, only the restart file is needed to continue the interrupted analysis.

## Procedure for LS-DYNA/MPP

As described above the serial/SMP code supports the use of the SIGINT signal (usually Ctrl-C) to interrupt the execution and prompt the user for a "sense switch." The MPP code also supports

## GETTING STARTED

---

this capability. However, on many systems a shell script or front end program (generally "mpirun") is required to start MPI applications. Pressing Ctrl-C on some systems will kill this process, and thus kill the running MPP-DYNA executable. As a workaround, when the MPP code begins execution it creates a file named "bg\_switch" in the current working directory. This file contains the following single line:

```
rsh <machine name> kill -INT <PID>
```

where <machine name> is the hostname of the machine on which the root MPP-DYNA process is running, and <PID> is its process id. (on HP systems, "rsh" is replaced by "remsh"). Thus, simply executing this file will send the appropriate signal.

For more information about running the LS-DYNA/MPP Version see Appendix O.

## Files: Input and Output

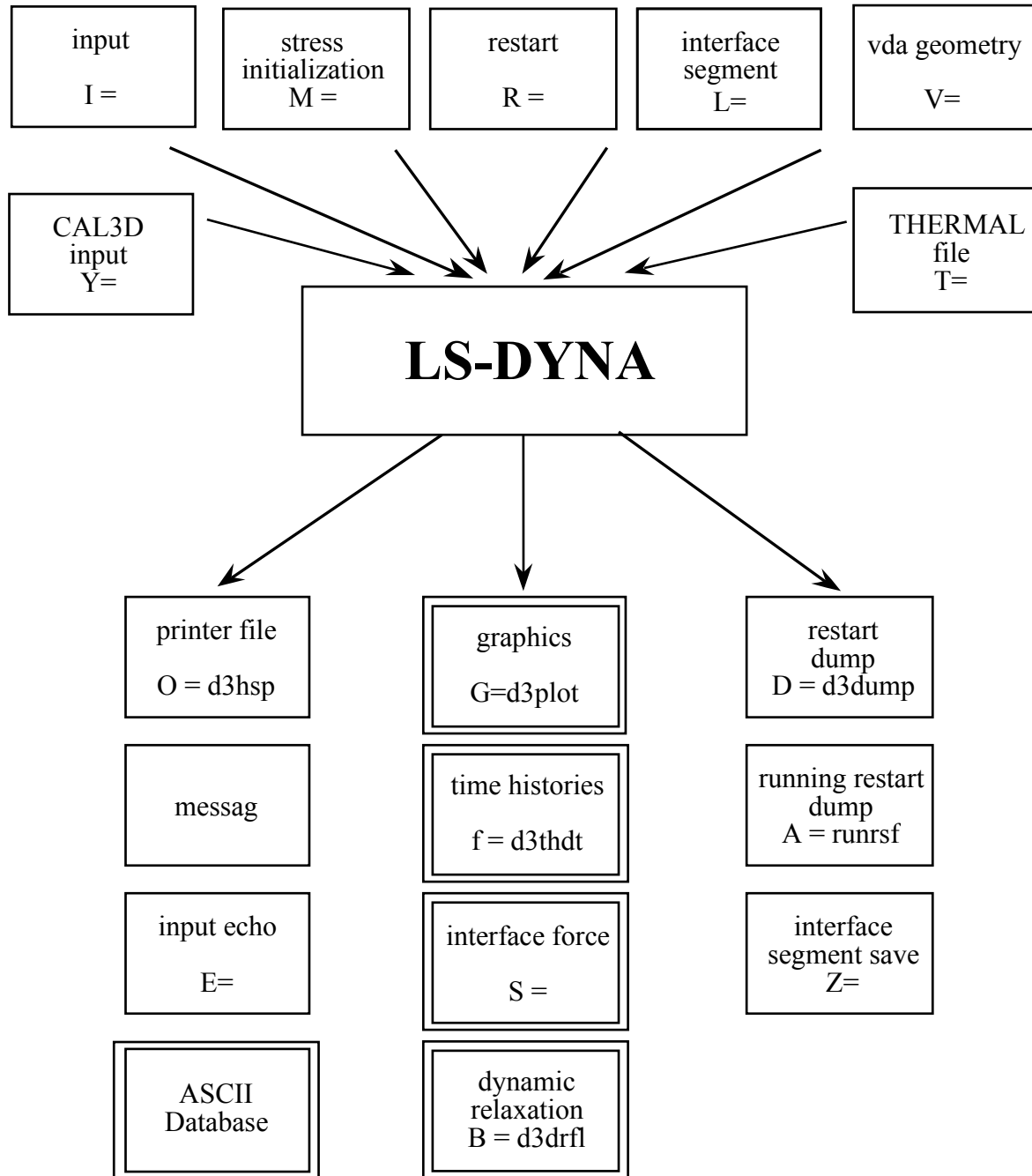


Figure 2.2

File names must be unique. The interface force file is created only if it is specified on the execution line ( $S=iff$ ). On large problems the default file sizes may not be large enough for a single file to hold either a restart dump or a plot state. Then the file size may be increased by specifying the file size on the execute line using  $X=scl$ . The default file size holds seven times

# GETTING STARTED

---

one-million octal word (262144) or 1835008 words. If the core required by LS-DYNA requires more space, it is recommended that the **scl** be increased appropriately. Using **C=cpu** defines the maximum cpu usage allowed that if exceeded will cause LS-DYNA to terminate with a restart file. During a restart, **cpu** should be set to the total cpu used up to the current restart plus whatever amount of additional time is wanted.

When **restarting from a dump file**, the execution line becomes

```
LS-DYNA I=inf O=otf G=ptf D=dpr R=rtf F=thf U=xtf T=tpf A=rrd J=jif S=iff Z=isf1 L=isf2  
B=rlf W=root E=efl X=scl C=cpu K=kill Q=option KEYWORD MEMORY=nwds
```

where

**rtf** = restart filename.

The adaptive dump files contain all information required to successfully restart so that no other files are needed except when CAD surface data is used. When restarting a problem that uses VDA/IGES surface data, the vda input file must be specified, e.g.:

```
LS-DYNA R=d3dump01 V=vda .....
```

If the data from the last run is to be remapped onto a new mesh, then specify: **Q=remap**. The remap file is the dump file from which the remapping data is taken. The remap option is available for brick elements only. File name dropouts are permitted; for example, the following execution lines are acceptable.

```
LS-DYNA I=inf  
LS-DYNA R=rtf
```

Default names for the output file, binary plot files, and the dump file are D3HSP, D3PLOT, D3THDT, and D3DUMP, respectively.

For an analysis using interface segments the execution line in the first analysis is given by:

```
LS-DYNA I=inf Z=isf1
```

and in the second by:

```
LS-DYNA I=inf L=isf1
```

**Batch execution** in some installations (e.g., GM) is controlled by file NAMES on unit 88. NAMES is a 2 line file in which the second line is blank. The first line of NAMES contains the execution line:

```
I=inf
```

if this is the initial run. For a restart the execution line becomes:

```
I=inf R=rtf
```

Remark: No stress initialization is possible at restart. Also the VDA files and the CAL3D files cannot be changed.

## RESTART ANALYSIS

The LS-DYNA restart capability allows analyses to be broken down into stages. After the completion of each stage in the calculation a “restart dump” is written that contains all information necessary to continue the analysis. The size of this “dump” file is roughly the same size as the memory required for the calculation. Results can be checked at each stage by post-processing the output databases in the normal way, so the chance of wasting computer time on incorrect analyses is reduced. The restart capability is frequently used to modify models by deleting excessively distorted elements, materials that are no longer important, and contact surfaces that are no longer needed. Output frequencies of the various databases can also be altered. Often, these simple modifications permit the calculation to continue on to a successful completion. Restarting can also help to diagnose why a model is giving problems. By restarting from a dump that is written before the occurrence of a numerical problem and obtaining output at more frequent intervals, it is often possible to identify where the first symptoms appear and what aspect of the model is causing them.

The format of the restart input file is described in this manual. If, for example, the user wishes to restart the analysis from dump state nn, contained in file D3DUMPnn, then the following procedure is followed:

1. Create the restart input deck, if required, as described in the Restart Section of this manual. Call this file restartinput.
2. By invoking the execution line:

LS-DYNA I=restartinput R=D3DUMPnn

execution begins. If no alterations to the model are made, then the execution line:

LS-DYNA R=D3DUMPnn

will suffice. Of course, the other output files should be assigned names if the defaults have been changed in the original run.

The R=D3DUMPnn on the status line informs the program that this is a restart analysis.

The full deck restart option allows the user to begin a new analysis, with deformed shapes and stresses carried forward from a previous analysis for selected materials. The new analysis can be different from the original, e.g., more contact surfaces, different geometry (of parts which are not carried forward), etc. Examples of applications include:

- Crash analysis continued with extra contact surfaces;
- Sheet metalforming continued with different tools for modeling a multi-stage forming process.

Assume an analysis is run using the input file, job1.inf, and a restart dump named d3dump01 is created. A new input file job2.inf is generated and submitted as a restart with R=d3dump01 as the dump file. The input file job2.inf contains the entire model in its original undeformed state but with more contact surfaces, new output databases, and so on. Since this is a restart job,

# GETTING STARTED

---

information must be given to tell LS-DYNA which parts of the model should be initialized in the full deck restart. When the calculation begins the restart database contained in the file d3dump01 is read, and a new database is created to initialize the model in the input file, job2.inf. The data in file job2.inf is read and the LS-DYNA proceeds through the entire input deck and initialization. At the end of the initialization process, all the parts selected are initialized from the data saved from d3dump01. This means that the deformed position and velocities of the nodes on the elements of each part, and the stresses and strains in the elements (and, if the material of the part is rigid, the rigid body properties) will be assigned.

It is assumed during this process that any initialized part has the same elements, in the same order, with the same topology, in job1 and job2. If this is not the case, the parts cannot be initialized. However, the parts may have different identifying numbers.

For discrete elements and seat belts, the choice is all or nothing. All discrete and belt elements, retractors, slings, pretensioners and sensors must exist in both files and will be initialized.

Materials which are not initialized will have no initial deformations or stresses. However, if initialized and non-initialized materials have nodes in common, the nodes will be moved by the initialized material causing a sudden strain in the non-initialized material. This effect could give rise to sudden spikes in loading.

Points to note are:

- Time and output intervals are continuous with job1, i.e., the time is not reset to zero.
- Don't try to use the restart part of the input to change anything since this will be overwritten by the new input file.
- Usually, the complete input file part of job2.in1 will be copied from job1.inf, with the required alterations. We again mention that there is no need to update the nodal coordinates since the deformed shapes of the initialized materials will be carried forward from job1.
- Completely new databases will be generated with the time offset.

## VDA/IGES DATABASES

VDA surfaces are surfaces of geometric entities which are given in the form of polynomials. The format of these surfaces is as defined by the German automobile and supplier industry in the VDA guidelines, [VDA 1987].

The advantage of using VDA surfaces is twofold. First, the problem of meshing the surface of the geometric entities is avoided and, second, smooth surfaces can be achieved which are very important in metalforming. With smooth surfaces, artificial friction introduced by standard faceted meshes with corners and edges can be avoided. This is a big advantage in springback calculations.

# GETTING STARTED

---

A very simple and general handling of VDA surfaces is possible allowing arbitrary motion and generation of surfaces. For a detailed description, see Appendix L.

## LS-PrePost®

LS-DYNA is designed to operate with a variety of commercial pre- and post-processing packages. Currently, direct support is available from TRUEGRID, PATRAN, eta/VPG, HYPERMESH, EASi-CRASH DYNA and FEMAP. Several third-party translation programs are available for PATRAN and IDEAS.

Alternately, the pre- and post-processor LS-PrePost is available from LSTC and is specialized for LS-DYNA. LS-PrePost is an advanced pre- and post-processor that is delivered free with LS-DYNA. The user interface is designed to be both efficient and intuitive. LS-PrePost runs on Windows, Linux, and Unix, utilizing OpenGL graphics to achieve fast model rendering and XY plotting.

Some of the capabilities available in LS-PrePost are:

- Complete support for all LS-DYNA keyword data.
- Importing and combining multiple models from many sources (LS-DYNA keyword, IDEAS neutral file, NASTRAN bulk data, STL ascii, and STL binary formats).
- Improved renumbering of model entities.
- Model Manipulation: Translate, Rotate, Scale, Project, Offset, Reflect
- LS-DYNA Entity Creation: Coordinate Systems, Sets, Parts, Masses, CNRBs, Boxes, Spot welds, SPCs, Rigidwalls, Rivets, Initial Velocity, Accelerometers, Cross Sections, etc.
- Mesh Generation: 2Dmesh Sketchboard, nLine Meshing, Line sweep into shell, Shell sweep into solid, Tet-Meshing, Automatic surface meshing of IGES and VDA data, Meshing of simple geometric objects (Plate, Sphere, Cylinder)
- Special Applications: Airbag folding, Dummy positioning, Seatbelt fitting, Initial penetration check, Spot weld generation using MAT\_100
- Complete support of LS-DYNA results data file: d3plot file, d3thdt file, All ascii time history data file, Interface force file

LS-PrePost processes output from LS-DYNA. LS-PrePost reads the binary plot-files generated by LS-DYNA and plots contours, fringes, time histories, and deformed shapes. Color contours and fringes of a large number of quantities may be interactively plotted on meshes consisting of plate, shell, and solid type elements. LS-PrePost can compute a variety of strain measures, reaction forces along constrained boundaries.

# GETTING STARTED

LS-DYNA generates three binary databases. One contains information for complete states at infrequent intervals; 50 to 100 states of this sort is typical in a LS-DYNA calculation. The second contains information for a subset of nodes and elements at frequent intervals; 1000 to 10,000 states is typical. The third contains interface data for contact surfaces.

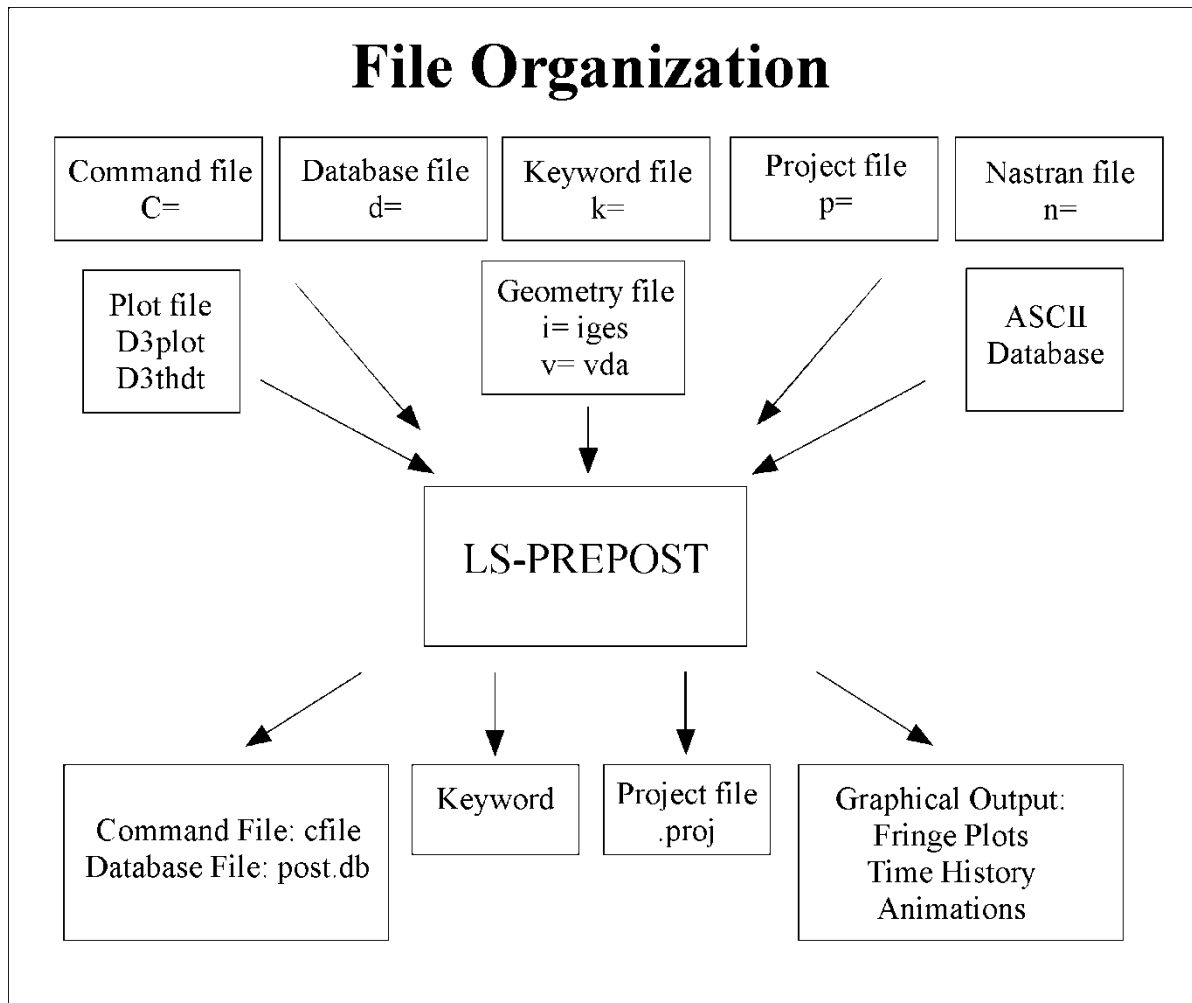


Figure 2.3

## EXECUTION SPEEDS

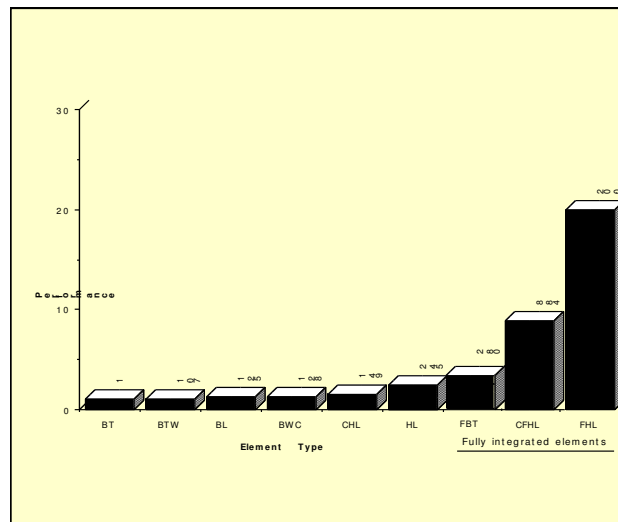
The relative execution speeds for various elements in LS-DYNA are tabulated below:

Element Type	Relative Cost
8 node solid with 1 point integration and default hourglass control	4
as above but with Flanagan-Belytschko hourglass control	5



Element Type	Relative Cost
constant stress and Flanagan-Belytschko hourglass control, i.e., the Flanagan-Belytschko element	7
4 node Belytschko-Tsay shell with four thickness integration points	4
4 node Belytschko-Tsay shell with resultant plasticity	3
BCIZ triangular shell with four thickness integration points	7
C <sup>0</sup> triangular shell with four thickness integration points	4
2 node Hughes-Liu beam with four integration points	9
2 node Belytschko-Schwer beam	2
2 node simple truss elements	1
8 node solid-shell with four thickness integration points	11

These relative timings are very approximate. Each interface node of the sliding interfaces is roughly equivalent to one-half zone cycle in cost. Figure 2.4 illustrates the relative cost of the various shell formulations in LS-DYNA.



**Figure 2.4** Relative cost of the four noded shells available in LS-DYNA where BT is the Belytschko-Tsay shell, BTW is the Belytschko-Tsay shell with the warping stiffness taken from the Belytschko-Wong-Chiang, BWC, shell. The BL shell is the Belytschko-Leviathan shell. CHL denotes the Hughes-Liu shell, HL, with one point quadrature and a co-rotational formulation. FBT is a Belytschko-Tsay like shell with full integration, FHL is the fully integrated Hughes-Liu shell, and the CFHL shell is its co-rotational version.

# GETTING STARTED

---

## UNITS

The units in LS-DYNA must be consistent. One way of testing whether a set of units is consistent is to check that:

$$1 \text{ (force unit)} = 1 \text{ (mass unit)} \times 1 \text{ (acceleration unit)}$$

$$\text{and that } 1 \text{ (acceleration unit)} = \frac{1 \text{ (lengthunit)}}{[1 \text{ (timeunit)}]^2}$$

Examples of sets of consistent units are:

	(a)	(b)	(c)
Length unit	meter	millimeter	millimeter
Time unit	second	second	millisecond
Mass unit	kilogram	tonne	kilogram
Force unit	Newton	Newton	kiloNewton
Young's Modulus of Steel	210.0E+09	210.0E+03	210.0
Density of Steel	7.85E+03	7.85E-09	7.85E-06
Yield stress of Mild Steel	200.0E+06	200.0	0.200
Acceleration due to gravity	9.81	9.81E+03	9.81E-03
Velocity equivalent to 30 mph	13.4	13.4E+03	13.4

## GENERAL CARD FORMAT

The following sections specify for each keyword the cards that must be defined and those cards that are optional. Each card is described in its fixed format form and is shown as a number of fields in an 80 character string. With the exception of "long format" input as described below, most cards are 8 fields with a length of 10 and a sample card is shown below. The card format is clearly stated if it is other than eight fields of 10.

As an alternative to fixed format, a card may be free format with the values of the variables separated by commas. When using comma-delimited values on a card, the number of characters used to specify a value must not exceed the field length for fixed format. For example, an I8 number is limited to a number of 99999999 and larger numbers with more than eight characters are unacceptable. Fixed and free formats can be mixed throughout the deck and even within different cards of a single command but not within a card.

# GETTING STARTED

## Card Format

	1	2	3	4	5	6	7	8
Variable	NSID	PSID	A1	A2	A3	KAT		
Type	I	I	F	F	F	I		
Default	none	none	1.0	1.0	0	1		
Remarks	1			2		3		

In the example shown above, the row labeled “Type” gives the variable type and is either F, for floating point or I, for an integer. The row labeled “Default” reveals the default value set for a variable if zero is specified, the field is left blank, or the card is not defined. The “Remarks” row refers to enumerated remarks at the end of the section.

### Long Format Input:

To accommodate larger or more precise values for input variables than are allowed by the standard format input as described above, a “long format” input option is available. One way of invoking long format keyword input is by adding “long=y” to the execution line. A second way is to add “long=y” to the \*KEYWORD command in the input deck.

long=y: read long keyword input deck; write long structured input deck.  
long=s: read standard keyword input deck; write long structured input deck.  
long=k: read long keyword input deck; write standard structured input deck.

The “long=s” option may be helpful in the rare event that the keyword input is of standard format but LS-DYNA reports an input error and the dyna.str file (see \*CONTROL\_STRUCTURED) reveals that one of more variables is incorrectly written to dyna.str as a series of asterisks due to inadequate field length(s) in dyna.str.

The “long=k” option really serves no practical purpose.

When long format is invoked for keyword input, input fields for each variable become 20 characters long with a maximum of four fields per line. In long format, only four variables can be defined per line, i.e., a “card” that requires eight variables and normally would fit on a single line must be spread over two lines of input.

You can mix long and standard format within one input deck by use of “+” or “-” signs within the deck. If the execution line indicates standard format, you can add “+” at the end of any keywords to invoke long format just for those keywords. For example, “\*NODE +” in place of

## GETTING STARTED

---

“\*NODE” invokes a read format of two lines per node (I20,3E20.0 on the first line and 2F20.0 on the second line).

Similarly, if the execution line indicates long format, you can add "-" at the end of any keywords to invoke standard format for those keywords. For example, “\*NODE -” in place of “\*NODE” invokes the standard read format of one line per node ( I8,3E16.0,2F8.0).

# **\*AIRBAG**

Purpose: Define an airbag or control volume.

The keyword \*AIRBAG provides a way of defining thermodynamic behavior of the gas flow into the airbag as well as a reference configuration for the fully inflated bag. The keyword cards in this section are defined in alphabetical order:

- \*AIRBAG\_OPTION1\_{OPTION2}\_{OPTION3}\_{OPTION4}**
- \*AIRBAG\_ADVANCED\_ALE**
- \*AIRBAG\_ALE**
- \*AIRBAG\_INTERACTION**
- \*AIRBAG\_PARTICLE**
- \*AIRBAG\_REFERENCE\_GEOMETRY\_OPTION\_OPTION**
- \*AIRBAG\_SHELL\_REFERENCE\_GEOMETRY**

**\*AIRBAG\_OPTION1\_{OPTION2}\_{OPTION3}\_{OPTION4}**

OPTION1 specifies one of the following thermodynamic relationships:

**SIMPLE\_PRESSURE\_VOLUME**  
**SIMPLE\_AIRBAG\_MODEL**  
**ADIABATIC\_GAS\_MODEL**  
**WANG\_NEFSKE**  
**WANG\_NEFSKE\_JETTING**  
**WANG\_NEFSKE\_MULTIPLE\_JETTING**  
**LOAD\_CURVE**  
**LINEAR\_FLUID**  
**HYBRID**  
**HYBRID\_JETTING**  
**HYBRID\_CHEMKIN**

OPTION2 specifies that an additional line of data is read for the WANG\_NEFSKE type thermodynamic relationships. The additional data controls the initiation of exit flow from the airbag. OPTION2 takes the single option:

**POP**

OPTION3 specifies that a constant momentum formulation is used to calculate the jetting load on the airbag an additional line of data is read in: OPTION3 takes the single option:

**CM**

OPTION4 given by:

**ID**

Specifies that an airbag ID and heading information will be the first card of the airbag definition. This ID is a unique number that is necessary for the identification of the airbags in the definition of airbag interaction via **\*AIRBAG\_INTERACTION** keyword. The numeric ID's and heading are written into the ABSTAT and D3HSP files.

**The following card is read if and only if the ID option is specified.**



<b>VARIABLE</b>	<b>DESCRIPTION</b>
PSCA	Pressure scale factor, $P_{sca}$ (default=1.0)
VINI	Initial filled volume, $V_{ini}$
MWD	Mass weighted damping factor, $D$
SPSF	Stagnation pressure scale factor, $0 \leq \gamma \leq 1$

**Remarks:**

The first card is necessary for all airbag options. The sequence for the following cards which is different for each option is explained on the next pages.

Lumped parameter control volumes are a mechanism for determining volumes of closed surfaces and applying a pressure based on some thermodynamic relationships. The volume is specified by a list of polygons similar to the pressure boundary condition cards or by specifying a material subset which represents shell elements which form the closed boundary. All polygon normals must be oriented to face outwards from the control volume. If holes are detected, they are assumed to be covered by planar surfaces.

$V_{sca}$  and  $P_{sca}$  allow for unit system changes from the inflator to the finite element model. There are two sets of volume and pressure used for each control volume. First, the finite element model computes a volume ( $V_{femod\ell}$ ) and applies a pressure ( $P_{femod\ell}$ ). The thermodynamics of a control volume may be computed in a different unit system; thus, there is a separate volume ( $V_{cvol\text{ume}}$ ) and pressure ( $P_{cvol\text{ume}}$ ) which are used for integrating the differential equations for the control volume. The conversion is as follows:

$$V_{cvol\text{ume}} = (V_{sca} V_{femod\ell}) - V$$

$$P_{femod\ell} = P_{sca} P_{cvol\text{ume}}$$

Damping can be applied to the structure enclosing a control volume by using a mass weighted damping formula:

$$F_i^d = m_i D (v_i - v_{cg})$$

where  $F_i^d$  is the damping force,  $m_i$  is the nodal mass,  $v_i$  is the velocity for a node,  $v_{cg}$  is the mass weighted average velocity of the structure enclosing the control volume, and  $D$  is the damping factor.

An alternative, separate damping is based on the stagnation pressure concept. The stagnation pressure is roughly the maximum pressure on a flat plate oriented normal to a steady state flow



field. The stagnation pressure is defined as  $p = \gamma\rho V^2$  where V is the normal velocity of the control volume relative to the ambient velocity,  $\rho$  is the ambient air density, and  $\gamma$  is a factor which varies from 0 to 1 and has to be chosen by the user. Small values are recommended to avoid excessive damping.

**Sensor Input to Activate Inflator**  
**Define if and only if RBID nonzero.**

Skip this input if RBID=0. If the rigid body ID is non-zero then define either the input for the user defined sensor subroutine (A) or define the data for the default sensor (B).

The sensor is mounted on a rigid body which is attached to the structure. The motion of the sensor is provided in the local coordinate system defined for the rigid body in the definition of the rigid material, see \*MAT RIGID. This is important since the default local system is taken as the principal axes of the inertia tensor. The local system rotates and translates with the rigid material. When the user defined criterion is met for the deployment of the airbag, a flag is set and the deployment begins. All load curves relating to the mass flow rate versus time are then shifted by the initiation time.

**A. Sensor Input for User Subroutine (RBID>0)**  
**See Appendix D. A user supplied subroutine must be provided.**

Define the following card sets which provide the input parameters for the user defined subroutine. Up to 25 parameters may be used with each control volume.

Card	1	2	3	4	5	6	7	8
Variable	N							
Type	I							
Default	none							

**Card Format (Define up to 25 constants for the user subroutine. Input only the number of cards necessary, i.e. for nine constants use 2 cards)**

Card	1	2	3	4	5	6	7	8
Variable	C1	C2	C3	C4	C5			
Type	F	F	F	F	F			
Default	0.	0.	0.	0.	0.			

<u>VARIABLE</u>	<u>DESCRIPTION</u>
N	Number of input parameters (not to exceed 25).
C1,...CN	Up to 25 constants for the user subroutine.

**B. LS-DYNA Sensor Input (RBID<0)**

Define three cards which provide the input parameters for the built in sensor subroutine.

**Acceleration/Velocity/Displacement Activation**

Card	1	2	3	4	5	6	7	8
Variable	AX	AY	AZ	AMAG	TDUR			
Type	F	F	F	F	F			
Default	0.	0.	0.	0.	0.			

Card            1            2            3            4            5            6            7            8

Variable	DVX	DVY	DVZ	DVMAG				
Type	F	F	F	F				
Default	0.	0.	0.	0.				

Card            1            2            3            4            5            6            7            8

Variable	UX	UY	UZ	UMAG				
Type	F	F	F	F				
Default	0.	0.	0.	0.				

<u>VARIABLE</u>	<u>DESCRIPTION</u>
AX	Acceleration level in local x-direction to activate inflator. The absolute value of the x-acceleration is used. EQ.0: inactive.
AY	Acceleration level in local y-direction to activate inflator. The absolute value of the y-acceleration is used. EQ.0: inactive.
AZ	Acceleration level in local z-direction to activate inflator. The absolute value of the z-acceleration is used. EQ.0: inactive.
AMAG	Acceleration magnitude required to activate inflator. EQ.0: inactive.
TDUR	Time duration acceleration must be exceeded before the inflator activates. This is the cumulative time from the beginning of the calculation, i.e., it is not continuous.
DVX	Velocity change in local x-direction to activate the inflator. (The absolute value of the velocity change is used.)

---

<b>VARIABLE</b>	<b>DESCRIPTION</b>
	EQ.0: inactive.
DVY	Velocity change in local y-direction to activate the inflator. (The absolute value of the velocity change is used.) EQ.0: inactive.
DVZ	Velocity change in local z-direction to activate the inflator. (The absolute value of the velocity change is used.) EQ.0: inactive.
DVMAG	Velocity change magnitude required to activate the inflator. EQ.0: inactive.
UX	Displacement increment in local x-direction to activate the inflator. (The absolute value of the x-displacement is used.) EQ.0: inactive.
UY	Displacement increment in local y-direction to activate the inflator. (The absolute value of the y-displacement is used.) EQ.0: inactive.
UZ	Displacement increment in local z-direction to activate the inflator. (The absolute value of the z-displacement is used.) EQ.0: inactive.
UMAG	Displacement magnitude required to activate the inflator. EQ.0: inactive.

**SIMPLE\_PRESSURE\_VOLUME** option:

**Additional card required for SIMPLE\_PRESSURE\_VOLUME option**

Card            1            2            3            4            5            6            7            8

Variable	CN	BETA	LCID	LCIDDR				
Type	F	F	I	I				
Default	none	none	none	0				

**VARIABLE**

**DESCRIPTION**

CN	Coefficient. Define if the load curve ID, LCID, is unspecified. LT.0.0:  CN  is the load curve ID, which defines the coefficient as a function of time.
BETA	Scale factor, $\beta$ . Define if a load curve ID is not specified.
LCID	Optional load curve ID defining pressure versus relative volume.
LCIDDR	Optional load curve ID defining the coefficient, CN, as a function of time during the dynamic relaxation phase.

**Remarks:**

The relationship is the following:

$$\text{Pressure} = \beta \frac{\text{CN}}{\text{Relative Volume}}$$

$$\text{Relative Volume} = \frac{\text{Current Volume}}{\text{Initial Volume}}$$

The pressure is then a function of the ratio of current volume to the initial volume. The constant, CN, is used to establish a relationship known from the literature. The scale factor  $\beta$  is simply used to scale the given values. This simple model can be used when an initial pressure is given and no leakage, no temperature, and no input mass flow is assumed. A typical application is the modeling of air in automobile tires.

The load curve, LCIDDR, can be used to ramp up the pressure during the dynamic relaxation phase in order to avoid oscillations after the desired gas pressure is reached. In the DEFINE\_CURVE section this load curve must be flagged for dynamic relaxation. After initialization either the constant or load curve ID, |CN| is used to determine the pressure.

**SIMPLE\_AIRBAG\_MODEL** option:

**Additional cards required for SIMPLE\_AIRBAG\_MODEL option**

Card 1            1            2            3            4            5            6            7            8

Variable	CV	CP	T	LCID	MU	A	PE	RO
Type	F	F	F	I	F	F	F	F
Default	none	none	none	none	none	none	none	none

Card 2            1            2            3            4            5            6            7            8

Variable	LOU	TEXT	A	B	MW	GASC		
Type	I	F	F	F	F	F		
Default	0	0.	0.	0.	0.	0.		
Remarks	0	optional	optional	optional	optional	optional		

<u>VARIABLE</u>	<u>DESCRIPTION</u>
CV	Heat capacity at constant volume
CP	Heat capacity at constant pressure
T	Temperature of input gas
LCID	Load curve ID specifying input mass flow rate. See *DEFINE_CURVE.
MU	Shape factor for exit hole, $\mu$ : LT.0.0: $ \mu $ is the load curve number defining the shape factor as a function of absolute pressure.
A	Exit area, A: GE.0.0: A is the exit area and is constant in time, LT.0.0: $ A $ is the load curve number defining the exit area as a

<u>VARIABLE</u>	<u>DESCRIPTION</u>
	function of absolute pressure.
PE	Ambient pressure, $p_e$
RO	Ambient density, $\rho$
LOU	<b>Optional</b> load curve ID giving mass flow out versus gauge pressure in bag. See *DEFINE_CURVE.
TEXT	Ambient temperature. (Define if and only if CV=0.)
A	First heat capacity coefficient of inflator gas (e.g., Joules/mole/°K). (Define if and only if CV=0.)
B	Second heat capacity coefficient of inflator gas, (e.g., Joules/mole/°K <sup>2</sup> ). (Define if and only if CV=0.)
MW	Molecular weight of inflator gas (e.g., Kg/mole). (Define if and only if CV=0.)
GASC	Universal gas constant of inflator gas (e.g., 8.314 Joules/mole/°K). (Define if and only if CV=0.)

**Remarks:**

The gamma law equation of state used to determine the pressure in the airbag:

$$p = (\gamma - 1) \rho e$$

where  $p$  is the pressure,  $\rho$  is the density,  $e$  is the specific internal energy of the gas, and  $\gamma$  is the ratio of the specific heats:

$$\gamma = \frac{c_p}{c_v}$$

From conservation of mass, the time rate of change of mass flowing into the bag is given as:

$$\frac{dM}{dt} = \frac{dM_{in}}{dt} - \frac{dM_{out}}{dt}$$

The inflow mass flow rate is given by the load curve ID, LCID. Leakage, the mass flow rate out of the bag, can be modeled in two alternative ways. One is to give an exit area with the corresponding shape factor, then the load curve ID, LOU, must be set to zero. The other is to define a mass flow out by a load curve, then  $\mu$  and A have to both be set to zero.

If CV=0. then the constant-pressure specific heat is given by:



$$c_p = \frac{(a + bT)}{MW}$$

and the constant-volume specific heat is then found from:

$$c_v = c_p - \frac{R}{MW}$$

**ADIABATIC\_GAS\_MODEL** option:

**Additional card required for ADIABATIC\_GAS\_MODEL option**

Card	1	2	3	4	5	6	7	8
Variable	PSF	LCID	GAMMA	P0	PE	RO		
Type	F	I	F	F	F	F		
Default	1.0	none	none	none	none	none		

<u>VARIABLE</u>	<u>DESCRIPTION</u>
PSF	Pressure scale factor
LCID	Optional load curve for preload flag. See *DEFINE_CURVE.
GAMMA	Ratio of specific heats
P0	Initial pressure (gauge)
PE	Ambient pressure
RO	Initial density of gas

**Remarks:**

The optional load curve ID, LCID, defines a preload flag. During the preload phase the function value of the load curve versus time is zero, and the pressure in the control volume is given as:

$$p = PSF p_0$$

When the **first nonzero** function value is encountered, the preload phase stops and the ideal gas law applies for the rest of the analysis. If LCID is zero, no preload is performed.

The gamma law equation of state for the adiabatic expansion of an ideal gas is used to determine the pressure after preload:

$$p = (\gamma - 1)\rho e$$

where p is the pressure,  $\rho$  is the density, e is the specific internal energy of the gas, and  $\gamma$  is the ratio of the specific heats:

$$\gamma = \frac{c_p}{c_v}$$

The pressure above is the absolute pressure, the resultant pressure acting on the control volume is:

$$p_s = PSF (p - p_e)$$

where PSF is the pressure scale factor. Starting from the initial pressure  $p_0$  an initial internal energy is calculated:

$$e_0 = \frac{p_0 + p_e}{\rho (\gamma - 1)}$$

WANG\_NEFSKE options:

**Additional 4 cards are required for all WANG\_NEFSKE models**

Card 1            1            2            3            4            5            6            7            8

Variable	CV	CP	T	LCT	LCMT	TVOL	LCDT	IABT
Type	F	F	F	I	I	F	I	F
Default	none	none	0.	0	none	0.	0.	not used

Card 2            1            2            3            4            5            6            7            8

Variable	C23	LCC23	A23	LCA23	CP23	LCCP23	AP23	LCAP23
Type	F	I	F	I	F	I	F	I
Default	none	0	none	0	none	0	0.0	0

Card 3            1            2            3            4            5            6            7            8

Variable	PE	RO	GC	LCEFR	POVER	PPOP	OPT	KNKDN
Type	F	F	F	I	F	F	F	I
Default	none	none	none	0	0.0	0.0	0.0	0

If the inflator is modeled, LCMT=0, define, the following card. If not, define but leave blank.

Card 4            1            2            3            4            5            6            7            8

Variable	IOC	IOA	IVOL	IRO	IT	LCBF		
Type	F	F	F	F	F	I		
Default	none	none	none	none	none	none		

Define the following card if and only if CV=0. This option allows temperature dependent heat capacities to be defined. See below.

Card 5            1            2            3            4            5            6            7            8

Variable	TEXT	A	B	MW	GASC	HCONV		
Type	F	F	F	F	F	F		
Default	none	none	none	none	none	none		

Define the following card if and only if the POP option is specified. Use this option to specify additional criteria for initiating exit flow from the airbag.

Card 5            1            2            3            4            5            6            7            8

Variable	TDP	AXP	AYP	AZP	AMAGP	TDURP	TDA	RBIDP
Type	F	F	F	F	F	F	F	I
Default	0.0	0.0	0.0	0.0	0.0	0.0	0.0	none

**VARIABLE****DESCRIPTION**

CV            Heat capacity at constant volume  
 CP            Heat capacity at constant pressure

<b>VARIABLE</b>	<b>DESCRIPTION</b>
T	Temperature of input gas. For temperature variations a load curve, LCT, may be defined.
LCT	Optional load curve number defining temperature of input gas versus time. This overrides columns T.
LCMT	Load curve specifying input mass flow rate or tank pressure versus time. If the tank volume, TVOL, is nonzero the curve ID is assumed to be tank pressure versus time. If LCMT=0, then the inflator has to be modeled, see Card 4. During the dynamic relaxation phase the airbag is ignored unless the curve is flagged to act during dynamic relaxation.
TVOL	Tank volume which is required only for the tank pressure versus time curve, LCMT.
LCDT	Load curve for time rate of change of temperature (dT/dt) versus time.
IABT	Initial airbag temperature. (Optional, generally not defined.)
C23	Vent orifice coefficient which applies to exit hole. Set to zero if LCC23 is defined below.
LCC23	The absolute value,  LCC23 , is a load curve ID. If the ID is positive, the load curve defines the vent orifice coefficient which applies to exit hole as a function of time. If the ID is negative, the vent orifice coefficient is defined as a function of relative pressure, $P_{air} / P_{bag}$ , see [Anagonye and Wang 1999]. In addition, LCC23 can be defined through DEFINE_CURVE_FUNCTION. A nonzero value for C23 overrides LCC23.
A23	If defined as a positive number, A23 is the vent orifice area which applies to exit hole. If defined as a negative number, the absolute value  A23  is a part ID, see [Anagonye and Wang, 1999]. The area of this part becomes the vent orifice area. Airbag pressure will not be applied to part  A23  representing venting holes if part  A23  is not included in SID, the part set representing the airbag. Set A23 to zero if LCA23 is defined below.
LCA23	Load curve number defining the vent orifice area which applies to exit hole as a function of <u>absolute</u> pressure, or LCA23 can be defined through DEFINE_CURVE_FUNCTION. A nonzero value for A23 overrides LCA23.
CP23	Orifice coefficient for leakage (fabric porosity). Set to zero if LCCP23 is defined below.

---

<u>VARIABLE</u>	<u>DESCRIPTION</u>
LCCP23	Load curve number defining the orifice coefficient for leakage (fabric porosity) as a function of time, or LCCP23 can be defined through DEFINE_CURVE_FUNCTION. A nonzero value for CP23 overrides LCCP23.
AP23	Area for leakage (fabric porosity)
LCAP23	Load curve number defining the area for leakage (fabric porosity) as a function of (absolute) pressure, or LCAP23 can be defined through DEFINE_CURVE_FUNCTION. A nonzero value for AP23 overrides LCAP23.
PE	Ambient pressure
RO	Ambient density
GC	Gravitational conversion constant (mandatory - no default). If consistent units are being used for all parameters in the airbag definition then unity should be input.
LCEFR	Optional curve for exit flow rate (mass/time) versus (gauge) pressure
POVER	Initial relative overpressure (gauge), $P_{over}$ in control volume
PPOP	Pop Pressure: relative pressure (gauge) for initiating exit flow, $P_{pop}$

<b>VARIABLE</b>	<b>DESCRIPTION</b>
OPT	<p>Fabric venting option, if nonzero CP23, LCCP23, AP23, and LCAP23 are set to zero.</p> <p>EQ. 1: Wang-Nefske formulas for venting through an orifice are used. Blockage is not considered.</p> <p>EQ. 2: Wang-Nefske formulas for venting through an orifice are used. Blockage of venting area due to contact is considered.</p> <p>EQ. 3: Leakage formulas of Graefe, Krummheuer, and Siejak [1990] are used. Blockage is not considered.</p> <p>EQ. 4: Leakage formulas of Graefe, Krummheuer, and Siejak [1990] are used. Blockage of venting area due to contact is considered.</p> <p>EQ. 5: Leakage formulas based on flow through a porous media are used. Blockage is not considered.</p> <p>EQ. 6: Leakage formulas based on flow through a porous media are used. Blockage of venting area due to contact is considered.</p> <p>EQ. 7: Leakage is based on gas volume outflow versus pressure load curve. Blockage of flow area due to contact is <u>not</u> considered. Absolute pressure is used in the porous-velocity-versus-pressure load curve, given as FAC(P) in the *MAT_FABRIC card.</p> <p>EQ. 8: Leakage is based on gas volume outflow versus pressure load curve. Blockage of flow area due to contact is considered. Absolute pressure is used in the porous-velocity-versus-pressure load curve, given as FAC(P) in the *MAT_FABRIC card.</p>
KNKDN	<p><u>Optional</u> load curve ID defining the knock down pressure scale factor versus time. This option only applies to jetting. The scale factor defined by this load curve scales the pressure applied to airbag segments which do not have a clear line-of-sight to the jet. Typically, at very early times this scale factor will be less than unity and equal to unity at later times. The full pressure is always applied to segments which can see the jets.</p>
IOC	Inflator orifice coefficient
IOA	Inflator orifice area
IVOL	Inflator volume
IRO	Inflator density
IT	Inflator temperature
LCBF	Load curve defining burn fraction versus time
TEXT	Ambient temperature.
A	First heat capacity coefficient of inflator gas (e.g., Joules/mole/°K)



<u>VARIABLE</u>	<u>DESCRIPTION</u>
B	Second heat capacity coefficient of inflator gas, (e.g., Joules/mole/°K <sup>2</sup> )
MW	Molecular weight of inflator gas (e.g., Kg/mole).
GASC	Universal gas constant of inflator gas (e.g., 8.314 Joules/mole/°K)
HCONV	Effective heat transfer coefficient between the gas in the air bag and the environment at temperature TEXT. If HCONV<0, then HCONV defines a load curve of data pairs (time, hconv).
TDP	Time delay before initiating exit flow after pop pressure is reached.
AXP	Pop acceleration magnitude in local x-direction. EQ.0.0: Inactive.
AYP	Pop acceleration magnitude in local y-direction. EQ.0.0: Inactive.
AZP	Pop acceleration magnitude in local z-direction. EQ.0.0: Inactive.
AMAGP	Pop acceleration magnitude. EQ.0.0: Inactive.
TDURP	Time duration pop acceleration must be exceeded to initiate exit flow. This is a cumulative time from the beginning of the calculation, i.e., it is not continuous.
TDA	Time delay before initiating exit flow after pop acceleration is exceeded for the prescribed time duration.
RBIDP	Part ID of the rigid body for checking accelerations against pop accelerations.

**Remarks:**

The gamma law equation of state for the adiabatic expansion of an ideal gas is used to determine the pressure after preload:

$$p = (\gamma - 1) \rho e$$

where p is the pressure,  $\rho$  is the density, e is the specific internal energy of the gas, and  $\gamma$  is the ratio of the specific heats:

$$\gamma = \frac{c_p}{c_v}$$

where  $c_v$  is the specific heat at constant volume, and  $c_p$  is the specific heat at constant pressure. A pressure relation is defined:

$$Q = \frac{p_e}{p}$$

where  $p_e$  is the external pressure and  $p$  is the internal pressure in the bag. A critical pressure relationship is defined as:

$$Q_{\text{crit}} = \left( \frac{2}{\gamma + 1} \right)^{\frac{\gamma}{\gamma - 1}}$$

where  $\gamma$  is the ratio of specific heats:

$$\gamma = \frac{c_p}{c_v}$$

If

$$Q \leq Q_{\text{crit}} \quad \text{then} \quad Q = Q_{\text{crit}}$$

Wang and Nefske define the mass flow through the vents and leakage by

$$\dot{m}_{23} = C_{23} A_{23} \frac{p}{R \sqrt{T_2}} Q^{\frac{1}{\gamma}} \sqrt{2 g_c \left( \frac{\gamma R}{\gamma - 1} \right) \left( 1 - Q^{\frac{\gamma - 1}{\gamma}} \right)}$$

and

$$\dot{m}'_{23} = C'_{23} A'_{23} \frac{p}{R \sqrt{T_2}} Q^{\frac{1}{\gamma}} \sqrt{2 g_c \left( \frac{\gamma R}{\gamma - 1} \right) \left( 1 - Q^{\frac{\gamma - 1}{\gamma}} \right)}$$

It must be noted that the gravitational conversion constant has to be given in consistent units. As an alternative to computing the mass flow out of the bag by the Wang-Nefske model, a curve for the exit flow rate depending on the internal pressure can be taken. Then, no definitions for C23, LCC23, A23, LCA23, CP23, LCCP23, AP23, and LCAP23 are necessary.

The airbag inflator assumes that the control volume of the inflator is constant and that the amount of propellant reacted can be defined by the user as a tabulated curve of fraction reacted versus time. A pressure relation is defined:

$$Q_{\text{crit}} = \frac{p_e}{p_i} = \left( \frac{2}{\gamma + 1} \right)^{\frac{\gamma}{\gamma - 1}}$$

where  $p_c$  is a critical pressure at which sonic flow occurs,  $p_i$ , is the inflator pressure. The exhaust pressure is given by

$$p_e = p_a \quad \text{if} \quad p_a \geq p_c$$

$$p_e = p_c \quad \text{if} \quad p_a < p_c$$

where  $p_a$  is the pressure in the control volume. The mass flow into the control volume is governed by the equation:

$$\dot{m}_{in} = C_o A_o \sqrt{2 p_i \rho_i} \sqrt{\frac{g_c \gamma \left( Q^{\frac{2}{\gamma}} - Q^{\frac{\gamma+1}{\gamma}} \right)}{\gamma - 1}}$$

where  $C_o$ ,  $A_o$ , and  $\rho_i$  are the inflator orifice coefficient, area, and gas density, respectively.

If OPT is defined, then for OPT set to 1 or 2 the mass flow rate out of the bag,  $\dot{m}_{out}$  is given by:

$$\dot{m}_{out} = \sqrt{g_c} \cdot \left[ \sum_{n=1}^{nairmats} (\text{FLC}(t)_n \cdot \text{FAC}(p)_n \cdot \text{Area}_n) \right] \cdot \sqrt{2 p \rho} \sqrt{\frac{\gamma \left( Q^{\frac{2}{\gamma}} - Q^{\frac{\gamma+1}{\gamma}} \right)}{\gamma - 1}}$$

where,  $\rho$  is the density of airbag gas, nairmats is the number of fabrics used in the airbag, and  $\text{Area}_n$  is the current unblocked area of fabric number n.

If OPT set to 3 or 4 then:

$$\dot{m}_{out} = \left[ \sum_{n=1}^{nairmats} (\text{FLC}(t)_n \cdot \text{FAC}(p)_n \cdot \text{Area}_n) \right] \cdot \sqrt{2 (p - p_{ext}) \rho}$$

and for OPT set to 5 or 6:

$$\dot{m}_{out} = \left[ \sum_{n=1}^{nairmats} (\text{FLC}(t)_n \cdot \text{FAC}(p)_n \cdot \text{Area}_n) \right] \cdot (p - p_{ext})$$

and for OPT set to 7 or 8 (may be comparable to an equivalent model ALE model):

$$\dot{m}_{out} = \sum_{n=1}^{nairmats} \text{FLC}(t)_n \cdot \text{FAC}(p)_n \cdot \text{Area}_n \cdot \rho_n$$

Note that for different OPT settings,  $\text{FAC}(p)_n$  has different meanings (all units shown just as demonstrations):

- For OPT of 1, 2, 3 and 4,  $\text{FAC}(P)$  is unit-less.

- For OPT of 5 and 6, FAC(P) has a unit of (s/m).
- For OPT of 7 or 8, FAC(P) is the gas volume outflow through a unit area per unit time thus has the unit of speed, i.e.  $\text{vol} \approx \text{m}^3 / (\text{m}^2 \cdot \text{s}) \approx \text{m}/\text{s} \approx \text{vel}(P)$ .

Multiple airbags may share the same part ID since the area summation is over the airbag segments whose corresponding part ID's are known. Currently, we assume that no more than ten materials are used per bag for purposes of the output. This constraint can be eliminated if necessary.

The total mass flow out will include the portion due to venting, i.e., constants C23 and A23 or their load curves above.

If CV=0, then the constant-pressure specific heat is given by:

$$c_p = \frac{(a + bT)}{MW}$$

and the constant-volume specific heat is then found from:

$$c_v = c_p - \frac{R}{MW}$$

### **Further additional 2 cards are required for JETTING models**

The following additional cards are defined for the WANG\_NEFSKE\_JETTING and WANG\_NEFSKE\_MULTIPLE\_JETTING options, two further cards are defined for each option. The jet may be defined by specifying either the coordinates of the jet focal point, jet vector head and secondary jet focal point, or by specifying three nodes located at these positions. The nodal point option is recommended when the location of the airbag changes as a function of time.

Define either card below but not both:

**1st additional card of 2 required for WANG\_NEFSKE\_JETTING option**

Card 1            1            2            3            4            5            6            7            8

Variable	XJFP	YJFP	ZJFP	XJVH	YJVH	ZJVH	CA	BETA
Type	F	F	F	F	F	F	F	F
Default	none	none	none	none	none	none	none	1.0
Remark	1	1	1	1	1	1		

**1st additional card of 2 required for WANG\_NEFSKE\_MULTIPLE\_JETTING option**

Card 1            1            2            3            4            5            6            7            8

Variable	XJFP	YJFP	ZJFP	XJVH	YJVH	ZJVH	LCJRV	BETA
Type	F	F	F	F	F	F	F	F
Default	none	none	none	none	none	none	none	1.0
Remark	1	1	1	1	1	1		

**2nd additional card of 2 required for WANG\_NEFSKE\_JETTING and WANG\_NEFSKE\_MULTIPLE\_JETTING option**

Card 2            1            2            3            4            5            6            7            8

Variable	XSJFP	YSJFP	ZSJFP	PSID	ANGLE	NODE1	NODE2	NODE3
Type	F	F	F	I	F	I	I	I
Default	none	none	none	none	none	0	0	0
Remark						1	1	1

<u>VARIABLE</u>	<u>DESCRIPTION</u>
XJFP	x-coordinate of jet focal point, i.e., the virtual origin in Figure 3.1. See Remark 1 below.
YJFP	y-coordinate of jet focal point, i.e., the virtual origin in Figure 3.1.
ZJFP	z-coordinate of jet focal point, i.e., the virtual origin in Figure 3.1.
XJVH	x-coordinate of jet vector head to defined code centerline
YJVH	y-coordinate of jet vector head to defined code centerline
ZJVH	z-coordinate of jet vector head to defined code centerline
CA	Cone angle, $\alpha$ , defined in radians. LT.0.0: $ \alpha $ is the load curve ID defining cone angle as a function of time
LCJRV	Load curve ID giving the spatial jet relative velocity distribution, see Figures 3.2 and 3.3. The jet velocity is determined from the inflow mass rate and scaled by the load curve function value corresponding to the value of the angle $\psi$ . Typically, the values on the load curve vary between 0 and unity. See *DEFINE_CURVE.
BETA	Efficiency factor, $\beta$ , which scales the final value of pressure obtained from Bernoulli's equation. LT.0.0: $ \beta $ is the load curve ID defining the efficiency factor as a function of time

<u>VARIABLE</u>	<u>DESCRIPTION</u>
XSJFP	x-coordinate of secondary jet focal point, passenger side bag. If the coordinates of the secondary point are (0,0,0) then a conical jet (driver's side airbag) is assumed.
YSJFP	y-coordinate of secondary jet focal point
ZSJFP	z-coordinate of secondary jet focal point
PSID	Optional part set ID, see *SET_PART. If zero all elements are included in the airbag.
ANGLE	Cutoff angle in degrees. The relative jet velocity is set to zero for angles greater than the cutoff. See Figure 3.3. This option applies to the MULTIPLE jet only.
NODE1	Node ID located at the jet focal point, i.e., the virtual origin in Figure 3.1. See Remark 1 below.
NODE2	Node ID for node along the axis of the jet.
NODE3	Optional node ID located at secondary jet focal point.

### **Remarks:**

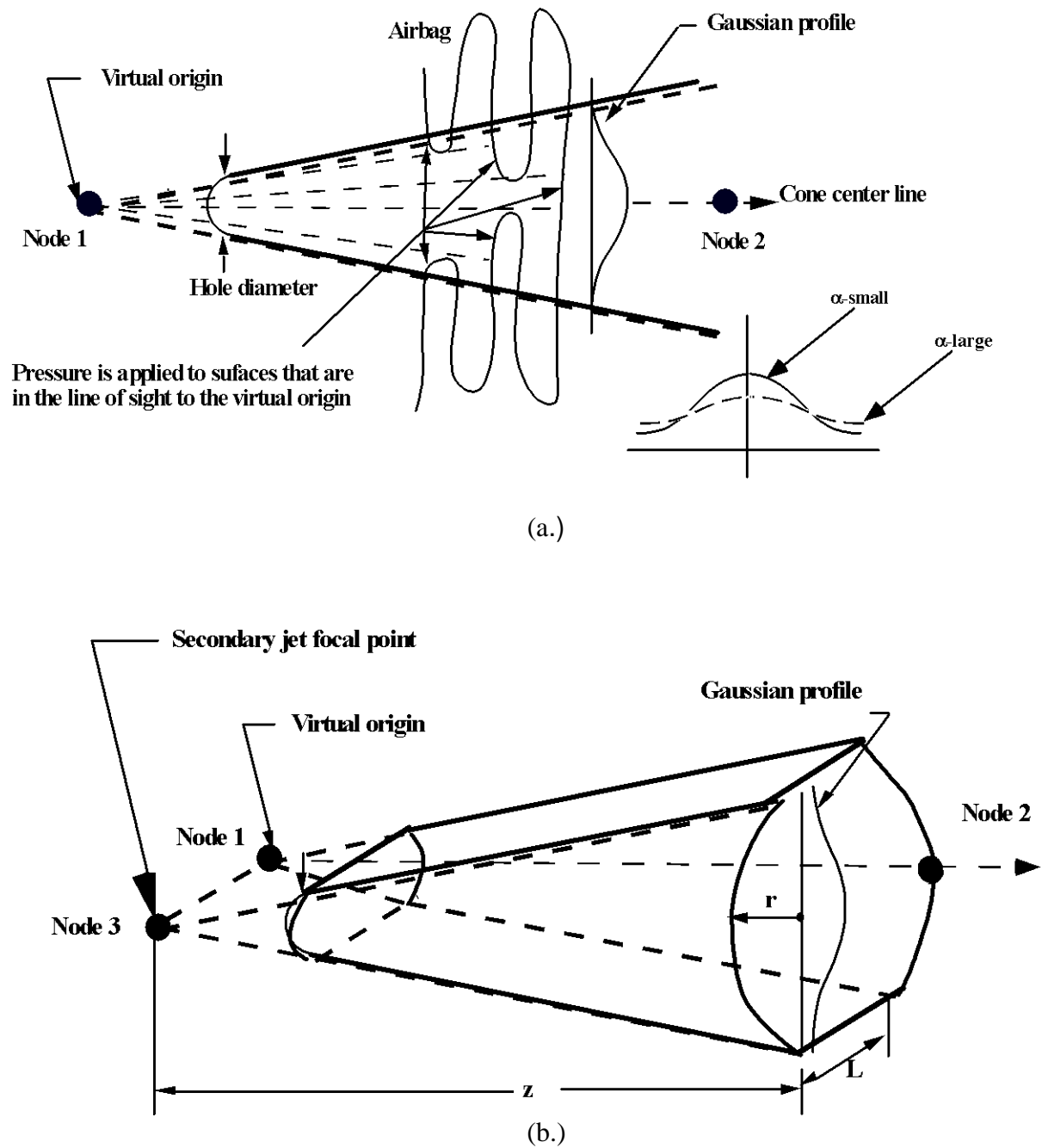
1. It is assumed that the jet direction is defined by the coordinate method (XJFP, YJFP, ZJFP) and (XJVH, YJVH, ZJVH) unless both NODE1 and NODE2 are defined. In which case the coordinates of the nodes give by NODE1, NODE2 and NODE3 will override (XJFP, YJFP, ZJFP) and (XJVH, YJVH, ZJVH). The use of nodes is recommended if the airbag system is undergoing rigid body motion. The nodes should be attached to the vehicle to allow for the coordinates of the jet to be continuously updated with the motion of the vehicle.

The jetting option provides a simple model to simulate the real pressure distribution in the airbag during the breakout and early unfolding phase. Only the surfaces that are in the line of sight to the virtual origin have an increased pressure applied. With the optional load curve LCRJV, the pressure distribution with the code can be scaled according to the so-called relative jet velocity distribution.

For passenger side airbags the cone is replaced by a wedge type shape. The first and secondary jet focal points define the corners of the wedge and the angle  $\alpha$  then defines the wedge angle.

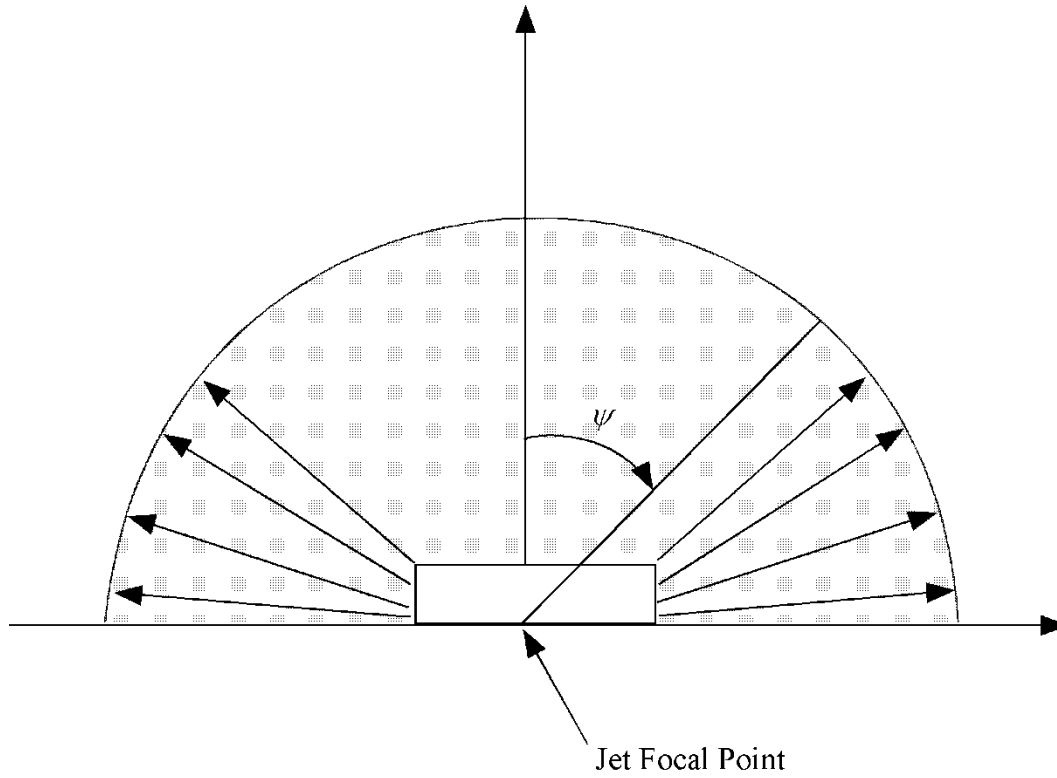
Instead of applying pressure to all surfaces in the line of sight of the virtual origin(s), a part set can be defined to which the pressure is applied.

- Care must be used to place the jet focal point within the bag. If the focal point is outside the bag, inside surfaces will not be visible so jetting pressure will not be applied correctly.

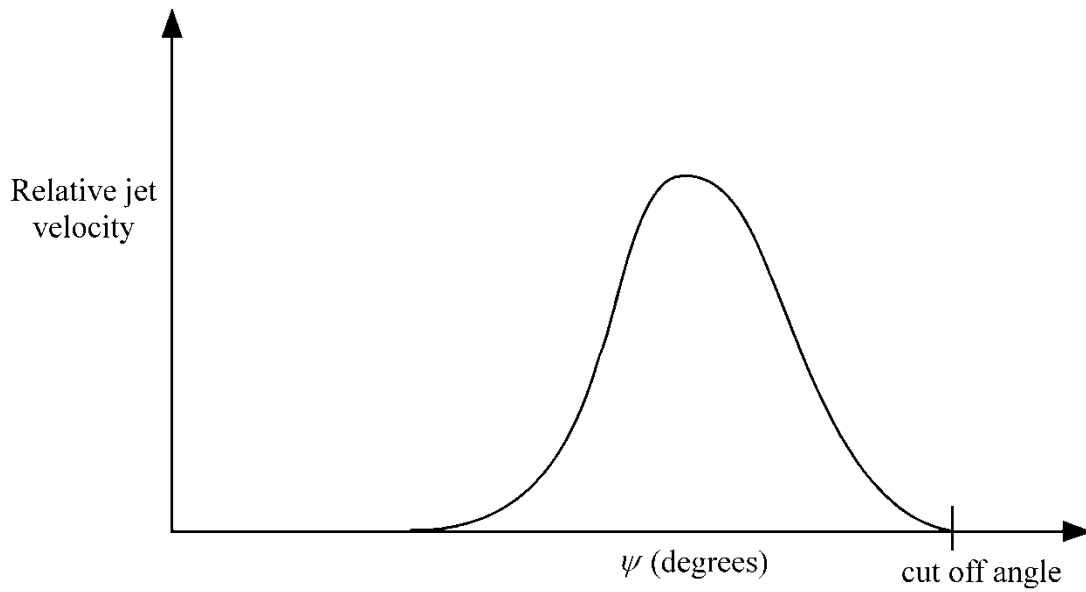


**Figure 3.1** Jetting configuration for (a.) driver's side airbag (pressure applied only if centroid of surface is in line-of-sight) and (b.) the passenger's side bag.





**Figure 3.2** Multiple jet model for driver's side airbag.



**Figure 3.3** Normalized jet velocity versus angle for multiple jet driver's side airbag.

**Further additional required for CM option.**

The following additional card is defined for the WANG\_NEFSKE\_JETTING\_CM and WANG\_NEFSKE\_MULTIPLE\_JETTING\_CM options.

**Additional card required for \_CM option**

Card 1            1            2            3            4            5            6            7            8

Variable	NREACT								
Type	I								
Default	None								
Remark									

<u>VARIABLE</u>	<u>DESCRIPTION</u>
NREACT	Node for reacting jet force. If zero the jet force will not be applied.

**Remarks:**

Compared with the standard LS-DYNA jetting formulation, the Constant Momentum option has several differences. Overall, the jetting usually has a more significant effect on airbag deployment than the standard LS-DYNA jetting: the total force is often greater, and does not reduce with distance from the jet.

The velocity at the jet outlet is assumed to be a choked (sonic) adiabatic flow of a perfect gas. Therefore the velocity at the outlet is given by:

$$v_{outlet} = \sqrt{\gamma RT} = \sqrt{\left( \frac{(c_p - c_v) T c_p}{c_v} \right)}$$

The density in the nozzle is then calculated from conservation of mass flow.

$$\rho_0 v_{outlet} A_{outlet} = \dot{m}$$

This is different from the standard LS-DYNA jetting formulation, which assumes that the density of the gas in the jet is the same as atmospheric air, and then calculates the jet velocity from conservation of mass flow.

The velocity distribution at any radius,  $r$ , from the jet centerline and distance,  $z$ , from the focus,  $v_{r,z}$ , relates to the velocity of the jet centerline,  $v_{r=0,z}$ , in the same way as the standard LS-DYNA jetting options:

$$v_{r,z} = v_{r=0,z} e^{-\left(\frac{r}{\alpha z}\right)^2}$$

The velocity at the jet centerline,  $v_{r=0}$ , at the distance,  $z$ , from the focus of the jet is calculated such that the momentum in the jet is conserved.

Momentum at nozzle = Momentum at  $z$

$$\begin{aligned} \rho_0 v_{\text{outlet}}^2 A_{\text{outlet}} &= \rho_0 \int v_{\text{jet}}^2 dA_{\text{jet}} \\ &= \rho_0 v_{r=0,z}^2 \left\{ b + F \sqrt{b} \right\} \end{aligned}$$

where

$$b = \frac{\pi (\alpha z)^2}{2}$$

$F$  = distance between jet focii for a passenger jet

Finally, the pressure exerted on an airbag element in view of the jet is given as:

$$p_{r,z} = \beta \rho_0 v_{r,z}^2$$

By combining the equations above

$$p_{r,z} = \frac{\beta \dot{m} v_{\text{outlet}} \left[ e^{-\left(\frac{r}{\alpha z}\right)^2} \right]^2}{\left\{ \frac{\pi (\alpha z)^2}{2} + F \sqrt{\frac{\pi (\alpha z)^2}{2}} \right\}}$$

The total force exerted by the jet is given by:

$$F_{\text{jet}} = \dot{m} v_{\text{outlet}} \quad (\text{independent of distance from the nozzle})$$

Mass flow in the jet is not necessarily conserved, because gas is entrained into the jet from the surrounding volume. By contrast, the standard LS-DYNA jetting formulation conserves mass flow but not momentum. This has the effect of making the jet force reduce with distance from the nozzle.

The jetting forces can be reacted onto a node (NREACT), to allow the reaction force through the steering column or the support brackets to be modeled. The jetting force is written to the ASCII ABSTAT file and the binary XTF file.

LOAD\_CURVE option:

**Additional card required for LOAD\_CURVE option**

Card	1	2	3	4	5	6	7	8
Variable	STIME	LCID	RO	PE	P0	T	T0	
Type	F	I	F	F	F	F	F	
Default	0.0	none	none	none	none	none	none	

<u>VARIABLE</u>	<u>DESCRIPTION</u>
STIME	Time at which pressure is applied. The load curve is offset by this amount.
LCID	Load curve ID defining pressure versus time, see *DEFINE_CURVE.
RO	Initial density of gas (ignored if LCID > 0)
PE	Ambient pressure (ignored if LCID > 0)
P0	Initial gauge pressure (ignored if LCID > 0)
T	Gas Temperature (ignored if LCID > 0)
T0	Absolute zero on temperature scale (ignored if LCID > 0)

**Remarks:**

Within this simple model the control volume is inflated with a pressure defined as a function of time or calculated using the following equation if LCID = 0.

$$P_{\text{total}} = C \rho (T - T_0)$$

$$P_{\text{gauge}} = P_{\text{total}} - P_{\text{ambient}}$$

The pressure is uniform throughout the control volume.

**LINEAR\_FLUID** option:

**Additional card required for LINEAR\_FLUID option**

Card            1            2            3            4            5            6            7            8

Variable	BULK	RO	LCINT	LCOUTT	LCOUTP	LCFIT	LCBULK	LCID
Type	F	F	I	I	I	I	I	I
Default	none	none	none	optional	optional	optional	optional	none

**If the next card is a “\*” keyword card, the following card is not read.**

Card            1            2            3            4            5            6            7            8

Variable	P_LIMIT	P_LIMLC						
Type	F	I						
Default	optional	optional						

**VARIABLE**

**DESCRIPTION**

BULK	K, bulk modulus of the fluid in the control volume. Constant as a function of time. Define if LCBULK=0.
RO	$\rho$ , density of the fluid
LCINT	F(t) input flow curve defining mass per unit time as a function of time, see *DEFINE_CURVE.
LCOUTT	G(t), output flow curve defining mass per unit time as a function of time. This load curve is optional.
LCOUTP	H(p), output flow curve defining mass per unit time as a function of pressure. This load curve is optional.
LCFIT	L(t), added pressure as a function of time. This load curve is optional.
LCBULK	Curve defining the bulk modulus as a function of time. This load curve

<u>VARIABLE</u>	<u>DESCRIPTION</u>
	is optional, but if defined, the constant, BULK, is not used.
LCID	Load curve ID defining pressure versus time, see *DEFINE_CURVE.
P_LIMIT	Limiting value on total pressure (optional).
P_LIMLC	Curve defining the limiting pressure value as a function of time. If nonzero, P_LIMIT is ignored.

**Remarks:**

If LCID = 0 then the pressure is determined from:

$$P(t) = K(t) \ln \left( \frac{V_0(t)}{V(t)} \right) + L(t)$$

where

$P(t)$  Pressure,

$V(t)$  Volume of fluid in compressed state,

$V_0(t) = V_0(t) = \frac{M(t)}{\rho}$  Volume of fluid in uncompressed state,

$M(t) = M(0) + \int F(t)dt - \int G(t)dt - \int H(p)dt$  Current fluid mass,

$M(0) = V(0)\rho$  Mass of fluid at time zero  $P(0) = 0$ .

By setting LCID  $\neq 0$  a pressure time history may be specified for the control volume and the mass of fluid within the volume is then calculated from the volume and density.

This model is for the simulation of hydroforming processes or similar problems. The pressure is controlled by the mass flowing into the volume and by the current volume. The pressure is uniformly applied to the control volume.

Note the signs used in the equation for  $M(t)$ . The mass flow should always be defined as positive since the output flow is subtracted.

**HYBRID and HYBRID\_JETTING options:**

**Additional cards required for HYBRID and HYBRID\_JETTING options**

Card            1            2            3            4            5            6            7            8

Variable	ATMOST	ATMOSP	ATMOSD	GC	CC	HCONV		
Type	F	F	F	F	F	F		
Default	none	none	none	none	1.0	none		

Card            1            2            3            4            5            6            7            8

Variable	C23	LCC23	A23	LCA23	CP23	LCP23	AP23	LCAP23
Type	F	I	F	I	F	I	F	I
Default	none	0	none	0	none	0	none	0

Card            1            2            3            4            5            6            7            8

Variable	OPT	PVENT	NGAS	LCEFR	LCIDM0			
Type	I	F	I	I	I			
Default	none	none	none	0	0			

Define 2\*NGAS cards below, two for each gas type.

Card            1            2            3            4            5            6            7            8

Variable	LCIDM	LCIDT		MW	INITM	A	B	C
Type	I	I	F	F	F	F	F	F
Default	none	none	not used	none	none	none	none	none

Card            1            2            3            4            5            6            7            8

Variable	FMASS							
Type	F							
Default	none							

<u>VARIABLE</u>	<u>DESCRIPTION</u>
ATMOST	Atmospheric temperature
ATMOSP	Atmospheric pressure
ATMOSD	Atmospheric density
GC	Universal molar gas constant
CC	Conversion constant EQ: .0 Set to 1.0.
HCONV	Effective heat transfer coefficient between the gas in the air bag and the environment at temperature at ATMOST. If HCONV<0, then HCONV defines a load curve of data pairs (time, hconv).
C23	Vent orifice coefficient which applies to exit hole. Set to zero if LCC23 is defined below.
LCC23	The absolute value,  LCC23 , is a load curve ID. If the ID is positive, the load curve defines the vent orifice coefficient which applies to exit hole as a function of time. If the ID is negative, the vent orifice



VARIABLE	DESCRIPTION
	coefficient is defined as a function of relative pressure, $P_{air} / P_{bag}$ , see [Anagonye and Wang 1999]. In addition, LCC23 can be defined through DEFINE_CURVE_FUNCTION. A nonzero value for C23 overrides LCC23.
A23	If defined as a positive number, A23 is the vent orifice area which applies to exit hole. If defined as a negative number, the absolute value  A23  is a part ID, see [Anagonye and Wang 1999]. The area of this part becomes the vent orifice area. Airbag pressure will not be applied to part  A23  representing venting holes if part  A23  is not included in SID, the part set representing the airbag. Set A23 to zero if LCA23 is defined below.
LCA23	Load curve number defining the vent orifice area which applies to exit hole as a function of <u>absolute</u> pressure, or LCA23 can be defined through DEFINE_CURVE_FUNCTION. A nonzero value for A23 overrides LCA23.
CP23	Orifice coefficient for leakage (fabric porosity). Set to zero if LCCP23 is defined below.
LCCP23	Load curve number defining the orifice coefficient for leakage (fabric porosity) as a function of time, or LCCP23 can be defined through DEFINE_CURVE_FUNCTION. A nonzero value for CP23 overrides LCCP23.
AP23	Area for leakage (fabric porosity)
LCAP23	Load curve number defining the area for leakage (fabric porosity) as a function of (absolute) pressure, or LCAP23 can be defined through DEFINE_CURVE_FUNCTION. A nonzero value for AP23 overrides LCAP23.
OPT	Fabric venting option, if nonzero CP23, LCCP23, AP23, and LCAP23 are set to zero. EQ. 1: Wang-Nefske formulas for venting through an orifice are used. Blockage is not considered. EQ. 2: Wang-Nefske formulas for venting through an orifice are used. Blockage of venting area due to contact is considered. EQ. 3: Leakage formulas of Graefe, Krummheuer, and Siejak [1990] are used. Blockage is not considered. EQ. 4: Leakage formulas of Graefe, Krummheuer, and Siejak [1990] are used. Blockage of venting area due to contact is considered. EQ. 5: Leakage formulas based on flow through a porous media are

<b>VARIABLE</b>	<b>DESCRIPTION</b>
	used. Blockage due to contact is not considered. EQ. 6: Leakage formulas based on flow through a porous media are used. Blockage due to contact is considered. EQ. 7: Leakage is based on gas volume outflow versus pressure load curve. Blockage of flow area due to contact is not considered. Absolute pressure is used in the porous-velocity-versus-pressure load curve, given as FAC(P) in the *MAT_FABRIC card. EQ. 8: Leakage is based on gas volume outflow versus pressure load curve. Blockage of flow area due to contact is considered.
PVENT	Gauge pressure when venting begins
NGAS	Number of gas inputs to be defined below (Including initial air). The maximum number of gases is 17.
LCEFR	Optional curve for exit flow rate (mass/time) versus (gauge) pressure
LCIDM0	Optional curve representing inflator's total mass inflow rate. When defined, LCIDM in the following 2xNGAS cards defines the molar fraction of each gas component as a function of time and INITM defines the initial molar ratio of each gas component .
LCIDM	Load curve ID for inflator mass flow rate (eq. 0 for gas in the bag at time=0) GT.0: piece wise linear interpolation LT.0: cubic spline interpolation
LCIDT	Load curve ID for inflator gas temperature (eq.0 for gas in the bag at time 0) GT.0: piece wise linear interpolation LT.0: cubic spline interpolation
BLANK	(not used)
MW	Molecular weight
INITM	Initial mass fraction of gas component
A	Coefficient for molar heat capacity of inflator gas at constant pressure, (e.g., Joules/mole/°K)
B	Coefficient for molar heat capacity of inflator gas at constant pressure, (e.g., Joules/mole/°K <sup>2</sup> )
C	Coefficient for molar heat capacity of inflator gas at constant pressure,

VARIABLEDESCRIPTION(e.g., Joules/mole/°K<sup>3</sup>)

FMASS          Fraction of additional aspirated mass.

**Further additional cards are required for HYBRID\_JETTING and ...\_CM models**

The following two additional cards are defined for the HYBRID\_JETTING options. The jet may be defined by specifying either the coordinates of the jet focal point, jet vector head and secondary jet focal point, or by specifying three nodes located at these positions. The nodal point option is recommended when the location of the airbag changes as a function of time.

Card 1            1            2            3            4            5            6            7            8

Variable	XJFP	YJFP	ZJFP	XJVH	YJVH	ZJVH	CA	BETA
Type	F	F	F	F	F	F	F	F
Default	none	none	none	none	none	none	none	none
Remark	1	1	1	1	1	1		

Card 2            1            2            3            4            5            6            7            8

Variable	XSJFP	YSJFP	ZSJFP	PSID	IDUM	NODE1	NODE2	NODE3
Type	F	F	F	I	F	I	I	I
Default	none	none	none	none	none	0	0	0
Remark					2	1	1	1

**Additional card required for HYBRID\_JETTING\_CM option**

Card 1            1            2            3            4            5            6            7            8

Variable	NREACT								
Type	I								
Default	None								
Remark	4								

<u>VARIABLE</u>	<u>DESCRIPTION</u>
XJFP	x-coordinate of jet focal point, i.e., the virtual origin in Figure 3.1. See Remark 1 below.
YJFP	y-coordinate of jet focal point, i.e., the virtual origin in Figure 3.1.
ZJFP	z-coordinate of jet focal point, i.e., the virtual origin in Figure 3.1.
XJVH	x-coordinate of jet vector head to defined code centerline
YJVH	y-coordinate of jet vector head to defined code centerline
ZJVH	z-coordinate of jet vector head to defined code centerline
CA	Cone angle, $\alpha$ , defined in radians. LT.0.0: $ \alpha $ is the load curve ID defining cone angle as a function of time
BETA	Efficiency factor, $\beta$ , which scales the final value of pressure obtained from Bernoulli's equation. LT.0.0: $ \beta $ is the load curve ID defining the efficiency factor as a function of time
XSJFP	x-coordinate of secondary jet focal point, passenger side bag. If the coordinate of the secondary point is (0,0,0) then a conical jet (driver's side airbag) is assumed.
YSJFP	y-coordinate of secondary jet focal point
ZSJFP	z-coordinate of secondary jet focal point

---

<u>VARIABLE</u>	<u>DESCRIPTION</u>
PSID	Optional part set ID, see *SET_PART. If zero all elements are included in the airbag.
IDUM	Dummy field (Variable not used)
NODE1	Node ID located at the jet focal point, i.e., the virtual origin in Figure 3.1. See Remark 1 below.
NODE2	Node ID for node along the axis of the jet.
NODE3	Optional node ID located at secondary jet focal point.
NREACT	Node for reacting jet force. If zero the jet force will not be applied.

**Remarks:**

1. It is assumed that the jet direction is defined by the coordinate method (XJFP, YJFP, ZJFP) and (XJVH, YJVH, ZJVH) unless both NODE1 and NODE2 are defined. In which case the coordinates of the nodes given by NODE1, NODE2 and NODE3 will override (XJFP, YJFP, ZJFP) and (XJVH, YJVH, ZJVH). The use of nodes is recommended if the airbag system is undergoing rigid body motion. The nodes should be attached to the vehicle to allow for the coordinates of the jet to be continuously updated with the motion of the vehicle.

The jetting option provides a simple model to simulate the real pressure distribution in the airbag during the breakout and early unfolding phase. Only the surfaces that are in the line of sight to the virtual origin have an increased pressure applied. With the optional load curve LCRJV, the pressure distribution with the code can be scaled according to the so-called relative jet velocity distribution.

For passenger side airbags the cone is replaced by a wedge type shape. The first and secondary jet focal points define the corners of the wedge and the angle  $\alpha$  then defines the wedge angle.

Instead of applying pressure to all surfaces in the line of sight of the virtual origin(s), a part set can be defined to which the pressure is applied.

2. This variable is not used and has been included to maintain the same format as the WANG\_NEFSKE\_JETTING options.
3. Care must be used to place the jet focal point within the bag. If the focal point is outside the bag, inside surfaces will not be visible so jetting pressure will not be applied correctly.

4. See the description related to the WANG\_NEFSKE\_JETTING\_CM option. For the hybrid inflator model the heat capacities are compute from the combination of gases which inflate the bag.

**HYBRID\_CHEMKN** option:

**Additional cards required for HYBRID\_CHEMKN model**

The HYBRID\_CHEMKN model includes 3 control cards. For each gas species an additional set of cards must follow consisting of a control card and several thermodynamic property data cards.

Card 1            1            2            3            4            5            6            7            8

Variable	LCIDM	LCIDT	NGAS	DATA	ATMT	ATMP	RG	
Type	I	I	I	I	F	F	F	
Default	none	none	none	none	none	none	none	

Card 2            1            2            3            4            5            6            7            8

Variable	HCONV							
Type	F							
Default	0.							

Card 3            1            2            3            4            5            6            7            8

Variable	C23	A23						
Type	F	F						
Default	0.	0.						

**VARIABLE**

**DESCRIPTION**

LCIDM

Load curve specifying input mass flow rate versus time.

---

<u>VARIABLE</u>	<u>DESCRIPTION</u>
	GT.0: piece wise linear interpolation LT.0: cubic spline interpolation
LCIDT	Load curve specifying input gas temperature versus time. GT.0: piece wise linear interpolation LT.0: cubic spline interpolation
NGAS	Number of gas inputs to be defined below. (Including initial air)
DATA	Thermodynamic database EQ.1. NIST database (3 additional property cards are required below) EQ.2. CHEMKIN database (no additional property cards are required) EQ.3. Polynomial data (1 additional property card is required below)
ATMT	Atmospheric temperature.
ATMP	Atmospheric pressure
RG	Universal gas constant
HCONV	Effective heat transfer coefficient between the gas in the air bag and the environment at temperature ATMT. If HCONV<0, then HCONV defines a load curve of data pairs (time, hconv).
C23	Vent orifice coefficient
A23	Vent orifice area

For each gas species include a set of cards consisting of a control card followed by several thermo-dynamic property data cards. The next "\*" card terminates the reading of this data.



**Control Card**

Card 1            1            2            3            4            5            6            7            8

Variable	CHNAME	MW	LCIDN	FMOLE	FMOLET			
Type	A	F	I	F	F			
Default	none	none	0	none	0.			

**VARIABLE****DESCRIPTION**

CHNAME	Chemical symbol for this gas species (e.g., N2 for nitrogen, AR for argon). Required for DATA=2 (CHEMKIN), optional for DATA=1 or DATA=3.
MW	Molecular weight of this gas species.
LCIDN	Load curve specifying the input mole fraction versus time for this gas species. If >0, FMOLE is not used.
FMOLE	Mole fraction of this gas species in the inlet stream.
FMOLET	Initial mole fraction of this gas species in the tank.

Additional thermodynamic data cards for each gas species. No additional cards are needed if using the CHEMKIN database (DATA=2).

**If DATA=1, include the following 3 cards for the NIST database.** The required data can be found on the NIST web site at <http://webbook.nist.gov/chemistry/>

Card 1            1            2            3            4            5            6            7            8

Variable	TLOW	TMID	THIGH					
Type	F	A8	F					
Default	none	none	none					

Card 2            1            2            3            4            5            6            7            8

Variable	alow	blow	clow	dlow	elow	flow	hlow	
Type	F	F	F	F	F	F	F	
Default	none	none	none	none	none	none	none	

Card 3            1            2            3            4            5            6            7            8

Variable	ahigh	bhigh	chigh	dhigh	ehigh	fhigh	hhigh	
Type	F	F	F	F	F	F	F	
Default	none	none	none	none	none	none	none	

**VARIABLE****DESCRIPTION**

TLOW	Curve fit low temperature limit.
TMID	Curve fit low-to-high transition temperature.
THIGH	Curve fit high temperature limit.
alow, . . . , hlow	Low temperature range NIST polynomial curve fit coefficients (see below).
ahigh, . . . , hhigh	High temperature range NIST polynomial curve fit coefficients (see below).

If DATA=3, include the following card for the polynomial curve fit.

Card 1            1            2            3            4            5            6            7            8

Variable	a	b	c	d	e			
Type	F	F	F	F	F			
Default	none	0.	0.	0.	0.			

**VARIABLE****DESCRIPTION**

a	Coefficient, see below.
b	Coefficient, see below.
c	Coefficient, see below.
d	Coefficient, see below.
e	Coefficient, see below.

Heat capacity curve fits:

NIST 
$$c_p = \frac{1}{M} \left( a + bT + cT^2 + dT^3 + \frac{e}{T^2} \right)$$

CHEMKIN 
$$c_p = \frac{\bar{R}}{M} \left( a + bT + cT^2 + dT^3 + eT^4 \right)$$

$\bar{R}$  = universal gas constant (8.314 Nm / mole K)  
M = gas molecular weight

Polynomial 
$$c_p = \frac{1}{M} \left( a + bT + cT^2 + dT^3 + eT^4 \right)$$

## \*AIRBAG\_ADVANCED\_ALE

Purpose: This \*AIRBAG\_ADVANCED\_ALE (AAA) card provides an alternate, simplified approach to simulating airbag deployment with ALE capabilities. Its input is translated into ALE keywords internally inside LS-DYNA (please review an output file called “advalebak.kw” which contains all the translated ALE commands). It has an option to start the simulation with the ALE method then switch to the control volume (CV) method at a chosen switch time. The CV input data may be used directly. A basic Lagrangian airbag shell structure may consist of an inflator compartment, an airbag, and possibly vent holes. The Lagrangian airbag interacts with the ALE inflator gas. The AAA card requires, at the minimum, one or more \*DEFINE\_ALEBAG\_INFLATOR cards (one for each inflator), and one or more \*DEFINE\_ALEBAG\_BAG cards (one for each bag structure). In addition, one optional card, \*DEFINE\_ALEBAG\_HOLE, may be used to define each physical vent hole on the airbag. Multiple fluid-to-structure interactions may be simulated using multiple AAA definitions. However, more complex couplings most likely must be modeled via the traditional ALE approach (remark 1)..

Card 1            1            2            3            4            5            6            7            8

Variable	BAGID1	BAGID2	BAGID3	BAGID4	BAGID5	BAGID6	BAGID7	BAGID8
Type	I	I	I	I	I	I	I	I
Default	none	none	none	none	none	none	none	none
Remarks								

Card 2            1            2            3            4            5            6            7            8

Variable	HOLEID1	HOLEID2	HOLEID3	HOLEID4	HOLEID5	HOLEID6	HOLEID7	HOLEID8
Type	I	I	I	I	I	I	I	I
Default	none	none	none	none	none	none	none	none
Remarks								

Card 3            1            2            3            4            5            6            7            8

Variable	INFLID1	INFLID2	INFLID3	INFLID4	INFLID5	INFLID6	INFLID7	INFLID8
Type	I	I	I	I	I	I	I	I
Default	none	none	none	none	none	none	none	none
Remarks	8							

**Define information related to the automatic ALE mesh generation**

Card 4            1            2            3            4            5            6            7            8

Variable	NX/IDA	NY	NZ	unused	ARSNID	IDCENT	EXSID	
Type	I	I	I		I	I	I	
Default	none	none	none		none	none	none	
Remarks	4	4	4					

**Optional, only define if NX & NY & NZ are nonzero, for automatic ALE mesh generation)**

Card 4            1            2            3            4            5            6            7            8

Variable	LX	LY	LZ	ITRANS	UIDAIR			
Type	F	F	F	I	I			
Default	none	none	none					
Remarks								

**Parameters for defining ambient environment CV \*AIRBAG\_PARAMETERS**

Card 5            1            2            3            4            5            6            7            8

Variable	ATMOST	ATMOSP	unused	GC	CC	unused	MWD	SPSF
Type	F	F		F	F		F	F
Default	0.	0.		none	1.0		0.0	0.0
Remarks	5	5						

**Parameters for defining ambient environment CV \*AIRBAG\_PARAMETERS**

Card 6            1            2            3            4            5            6            7            8

Variable	SWTIME	unused	HG	NAIR				
Type	F		F	I				
Default	0.		0.	0				
Remarks	6							

**Define air: repeat this card "NAIR" times. NAIR is defined in Card 6**

Card            1            2            3            4            5            6            7            8

Variable	unused	unused	unused	MWAIR	INITM	AIRA	AIRB	AIRC
Type				F	F	F	F	F
Default				0	0	0	0.	0.
Remarks						2		

---

<u>VARIABLE</u>	<u>DESCRIPTION</u>
BAGID#	Each BAGID refers to an airbag definition defined via a corresponding *DEFINE_ALEBAG_BAG (DAB) card. Each DAB card defines (a) one Lagrangian shell structure representing an airbag (or part of one), (b) its venting characteristics, and (c) its coupling behavior..
HOLEID#	Each HOLEID refers to a vent hole definition defined via a corresponding *DEFINE_ALEBAG_HOLE (DAH) card. Each DAH defines the information required for modeling a physical venting hole including the switching of the ALE multi-material group (AMMG) ID when a gas passes through this vent hole. The information in DAH is translated into a simplified form of the *ALE_FSI_SWITCH_MMG_ID (AFSM) card.
INFLID#	Each INFLID refers to one inflator definition defined via a corresponding *DEFINE_ALEBAG_INFLATOR (DAI) card. Each DAI defines the information required for the modeling of a physical inflator (which pumps a gas mixture in to inflate the airbag).
NX/IDA	Option 1: NX is defined as the number of ALE elements to be generated by LS-DYNA automatically in the x direction. If option 1 is chosen, option 1 must also be used for NY and NZ, and card 4B must also be defined. Option 2: IDA is the Part ID of the initial background air mesh (remarks 4 and 9). If IDA is a negative integer, the PID of the air mesh is the same as the one used in a previous AAA card. This approach is only used in the cases of (a) bag-in-bag or (b) bag-to-bag model where there may be more than one AAA card defined.
NY	Option 1: NY is defined as the number of ALE elements to be generated by LS-DYNA automatically in the y direction. If option 1 is chosen, option 1 must also be used for NX and NZ, and card 4B must also be defined. Option 2: Leave blank or 0 (remark 4).
NZ	Option 1: NZ is defined as the number of ALE elements to be generated by LS-DYNA automatically in the z direction. If option 1 is chosen, option 1 must also be used for NX and NY, and card 4B must also be defined Option 2: Leave blank or 0 (remark 4).

---

<b>VARIABLE</b>	<b>DESCRIPTION</b>
ARSNID	An ID associated with an *ALE_REFERENCE_SYSTEM_NODE card defining 3 nodes making up a local coordinate system. The ALE mesh system will automatically follow this local coordinate system. If there is mesh expansion, and if IDCENT > 0, the expansion will occur along these local axes. Else if IDCENT is not defined (0), the expansion will occur along the global coordinate axes.
IDCENT	A Lagrangian node ID defines the center of expansion for the ALE mesh system. For example, this node may be located on a rigid section of a steering wheel, near the inflator region. The ALE mesh can then move with the steering wheel as it expands. This provides a similar expansion mechanism the *ALE_REFERENCE_SYSTEM_GROUP command (PRTYPE=9).
EXSID	A part ID which makes up a portion of the overall the ALE mesh system to be excluded from expansion. This part can still move with the rest of the ALE system, but will not expand with the rest. This may be used to exclude the inner ALE mesh region surrounding the inflator (which is typically finer resolution to better resolve the inflator gas inflow at the orifices).
LX	Absolute length in the global X-coordinate of the ALE mesh
LY	Absolute length in the global Y-coordinate of the ALE mesh
LZ	Absolute length in the global Z-coordinate of the ALE mesh
ITRANS	An integer ID pointing an ID of a *DEFINE_TRANSFORMATION card which may be used to position the automatically generated ALE mesh at its chosen location and orientation. The mesh is first generated with respect to the origin of the global coordinate system. Then it is moved to the t=0 position via this *DEFINE_TRANSFORMATION card.
UIDAIR	User-defined PID number for the background ALE air mesh. If this is left blank, LS-DYNA will assign a PID for this automatically generated ALE mesh. This may be used to actively define the PID number for the ALE mesh
ATMOST	Atmospheric ambient temperature (See Remark 5).
ATMOSP	Atmospheric ambient pressure (See Remark 5).
GC	Universal molar gas constant.



VARIABLE	DESCRIPTION
CC	Conversion constant. EQ: 0.0 Set to 1.0.
MWD	Mass weighted damping factor, D
SPSF	Stagnation pressure scale factor.
SWTIME	Time to switch from ALE method to control volume (CV) method. Once switched, the airbag inflation is simulated by a control volume method similar to that used by the *AIRBAG_HYBRID card (See Remark 6). EQ.0.0: switch to CV method at time = 0.0. EQ.blank: switch time is set at 1.0E16 (ALE method is used). EQ.t: switch from ALE to CV method at time = t.
HG	Hourglass coefficient for ALE fluid mesh(es). A typical value on the order of 1.0E-5 or 1.0E-6 may be used for gases and liquids.
NAIR	Number of species for air. If air is defined as 1 single gas then NAIR=1. Card 7 is repeated "NAIR" number of times, one for each species. For example, NAIR=2 for a 2-component air model containing 80% of N2 and 20% of O2. Then card 7 is defined twice.
MWAIR	Molecular weight of this air component
INITMFA	Initial Mass Fraction of this air component
AIRA	First Coefficient of molar heat capacity at constant pressure (e.g., J/mole/K, See Remark 2).
AIRB	Second Coefficient of molar heat capacity at constant pressure (e.g., J/mole/K <sup>2</sup> ).
AIRC	Third Coefficient of molar heat capacity at constant pressure (e.g., J/mole/K <sup>3</sup> ).

**Remarks:**

- This card defines information for simulating an airbag deployment. It defines:
  - The IDs of the bags, vent holes, and inflators;
  - Information about the ALE background (air) mesh;
  - Basic ambient condition (similar to that from \*AIRBAG\_HYBRID);
  - Switch time (time for switching from ALE to CV method);
  - Material properties of air and some other miscellaneous information.

As the input to this command, \*AIRBAG\_ADVANCED\_ALE, is simply translated into the traditional ALE keywords, this command will not have all the flexibilities that the general ALE method allows. It does not provide a grammatical framework for understanding the modeling of fluid structure interaction. It is recommended that the users familiarize themselves with the traditional method of modeling airbag deployment using the ALE method. This is critical in understanding the interactions between the ALE inflator gas and the Lagrangian airbag structure.

2. The per-mass-unit, temperature-dependent, constant-pressure heat capacity is

$$C_p(T) = \frac{[A + B * T + C * T^2]}{MW} \sim \frac{J}{kg * K}$$

$$A = \tilde{C}_{p0} \sim J / (\text{mole} * K)$$

$$B \sim J / (\text{mole} * K^2)$$

$$C \sim J / (\text{mole} * K^3)$$

The units shown are only for demonstration of the equation.

3. In general, it is best to locate a point source near the center of an ALE element. Associated with each point source is an area and a vector indicating flow direction. Each point source should occupy 1 ALE element by itself, and there should be at least 2 empty ALE elements between any 2 point sources. A point source should be located at least 3 elements away from the free surface of an ALE mesh for stability (see **\*SECTION\_POINT\_SOURCE\_MIXTURE** card)
4. There are 2 options for defining the ALE mesh for an airbag deployment simulation. Option 1 lets LS-DYNA generate the background ALE mesh. NX, NY and NZ must be defined. Card 4b must also be defined. Option 2 uses an existing ALE mesh for the background air. The PID of this ALE mesh is defined via IDA (same as the NX field). In this case, the background ALE air mesh should envelope the airbag deployment space. There is no need to define card 4b. If IDA is a negative integer, the PID for the air mesh is the same as the one used in another AAA card (multiple AAA cards implied).
5. Atmospheric density for the ambient gas (air) can be computed from  $\rho_{amb} = P_{amb} / (R * T_{amb})$ . This card is similar to the 1<sup>st</sup> additional card for the \*AIRBAG\_HYBRID command with 2 additional parameters (MWD & SPSF) from the 1<sup>st</sup> card of the \*AIRBAG\_ command.
6. Since ALL ALE related activities will be turned off after the switch from ALE method to control-volume method, no other ALE coupling will exist beyond t=SWTIME. Using the traditional ALE modeling method, this switching can also be modeled via the command \*ALE\_UP\_SWITCH. The user should review its usage as it can provide extensively more coupling controls for general airbag modeling.

7. The \*AIRBAG\_ADVANCED\_ALE (AAA) card may be considered an alternate approach for inputting the information required by the traditional ALE card:

**\*AIRBAG\_ADVANCED\_ALE**

<b>Air</b>	→	<b>*PART (AMMG2) *SECTION_SOLID *MAT_GAS_MIXTURE</b>
<b>Gas</b>	→	<b>*PART (AMMG1) *SECTION_POINT_SOURCE_MIXTURE *MAT_GAS_MIXTURE</b>
<b>Multiple Couplings</b>	→	<b>*CONSTRAINED_LAGRANGE_IN_SOLID</b>
<b>CV</b>	→	<b>*AIRBAG_HYBRID</b>
<b>Multiple Vents</b>	→	<b>Venting definitions as in *CONSTRAINED_LAGRANGE_IN_SOLID</b>
<b>Multiple airbags structure</b>	→	<b>Defined separately in *DEFINE_ALEBAG_BAG</b>
<b>Multiple inflators</b>	→	<b>Defined separately in *DEFINE_ALEBAG_INFLATOR</b>

**\*AIRBAG\_ALE**

Purpose: The input in this section provides a simplified approach to defining the deployment of the airbag using the ALE capabilities with an option to switch from the initial ALE method to control volume (CV) method (\*AIRBAG\_HYBRID) at a chosen time. An enclosed airbag (and possibly the airbag canister/compartments and/or a simple representation of the inflator) shell structure interacts with the inflator gas(es). This definition provides a single fluid to structure coupling for the airbag-gas interaction during deployment in which the CV input data may be used directly.

Card 1            1            2            3            4            5            6            7            8

Variable	SID	SIDTYP					MWD	SPSF
Type	I	I					F	F
Default	none	none					0	0
Remarks	1							

**VARIABLE****DESCRIPTION**

SID	Set ID as defined on *AIRBAG card. This set ID contains the Lagrangian elements (segments) which make up the airbag and possibly the airbag canister/compartments and/or a simple representation of the inflator. See Remark 1.
SIDTYP	Set type: EQ.0: Segment set. EQ.1: Part set.
MWD	Mass weighted damping factor, D. This is used during the CV phase for *AIRBAG_HYBRID.
SPSF	Stagnation pressure scale factor, $0 \leq \gamma \leq 1$ . This is used during the CV phase for *AIRBAG_HYBRID.

**Parameters for defining ambient environment.**

Card 2            1            2            3            4            5            6            7            8

Variable	ATMOST	ATMOSP		GC	CC	TNKVOL	TNKFINP	
Type	F	F		F	F	F	F	
Default	0.	0.		none	1.0	0.0	0.0	
Remarks	2	2				10	10	

**VARIABLE****DESCRIPTION**

ATMOST	Atmospheric ambient temperature. See Remark 2.
ATMOSP	Atmospheric ambient pressure. See Remark 2.
GC	Universal molar gas constant.
CC	Conversion constant. If EQ: .0 Set to 1.0.
TNKVOL	Tank volume from the inflator tank test – or – Inflator canister volume. See remark 10. Option 1: (LCVEL = 0) This is defined as Tank volume (must also define TNKFINP). Inlet gas velocity is estimated by LS-DYNA method (testing). Option 2: (LCVEL = 0) This is defined as estimated inflator canister volume (must NOT define TNKFINP). Inlet gas velocity is estimated automatically by the Lian-Bhalsod-Olovsson method. Option 3: (LCVEL .NE. 0) This must be left blank.
TNKFINP	Tank final pressure from the inflator tank test data. Only define this parameter for option 1 of TNKVOL definition above. See Remark 10.

Parameters for coupling, see keyword **\*CONSTRAINED\_LAGRANGE\_IN\_SOLID**.

Card 3            1            2            3            4            5            6            7            8

Variable	NQUAD	CTYPE	PFAC	FRIC	FRCMIN	NORMTYP	ILEAK	PLEAK
Type	I	I	F	F	F	I	I	F
Default	4	4	0.1	0.0	0.3	0	2	0.1
Remarks	13	13	14					

**VARIABLE****DESCRIPTION**

NQUAD	Number of (quadrature) coupling points for coupling Lagrangian slave parts to ALE master solid parts. If NQUAD=n, then nXn coupling points will be parametrically distributed over the surface of each Lagrangian slave segment (default=4). See Remark 13.
CTYPE	Coupling type (default=4, see Remark 13): EQ.4: (default) penalty coupling with DIREC=2 implied. EQ.6: penalty coupling in which DIREC is automatically set to DIREC=1 for the unfolded region and DIREC=2 for folded region.
PFAC	Penalty factor. PFAC is a scale factor for scaling the estimated stiffness of the interacting (coupling) system. It is used to compute the coupling forces to be distributed on the slave and master parts. If positive real:            Fraction of estimated critical stiffness (default=0.1). If negative integer, -n: Refers to load curve ID n. The curve defines the relative coupling pressure (y-axis) as a function of the tolerable fluid penetration distance (x-axis).
FRIC	Coupling coefficient of friction.
FRCMIN	Minimum fluid volume fraction in an ALE element to activate coupling (default is 0.3).
NORMTYP	Penalty coupling spring direction (DIREC 1 and 2): EQ.0: normal vectors are interpolated from nodal normals (default) EQ.1: normal vectors are interpolated from segment normals.
ILEAK	Leakage control flag. Default=2 (with energy compensation).

**VARIABLE**

**DESCRIPTION**

PLEAK                      Leakage control penalty factor (default=0.1)

**Parameters for airbag venting hole**

Card 4                      1                      2                      3                      4                      5                      6                      7                      8

Variable	IVSETID	IVTYPE	IBLOCK	VNTCOF				
Type	I	I	I	F				
Default	0	0	0	0.0				
Remarks	4		5	6				

**VARIABLE**

**DESCRIPTION**

IVSETID                      Set ID defining the venting hole surface(s). See Remark 4.

IVTYPE                      Set type of IVSETID:  
EQ.0: Part Set (default).  
EQ.1: Part ID.  
EQ.2: Segment Set.

IBLOCK                      Flag for considering blockage effects for porosity and vents (see Remark 5):  
EQ.0: no (blockage is NOT considered, default).  
EQ.1: yes (blockage is considered).

VNTCOF                      Vent Coefficient for scaling the flow. See Remark 6.

**Parameters for ALE mesh automatic definition and its transformation.**

Card 5            1            2            3            4            5            6            7            8

Variable	NX/IDA	NY/IDG	NZ	MOVERN	ZOOM			
Type	I	I	I	I	I			
Default	None	None	None	0	0			
Remarks	7	7	7	8	9			

<u>VARIABLE</u>	<u>DESCRIPTION</u>
NX/IDAIR	Option 1: NX is defined (as the number of ALE elements to be generated in the x direction). This must goes together with option 1 for NY and NZ. Option 2: IDAIR is defined as Part ID of the initial air mesh. See remark 7.
NY/IDGAS	Option 1: NY is defined (as the number of ALE elements to be generated in the y direction). This must goes together with option 1 for NX and NZ. Option 2: IDGAS is defined as Part ID of the initial gas mesh. See remark 7.
NZ	Option 1: NZ is defined (as the number of ALE elements to be generated in the z direction). This must goes together with option 1 for NX and NY. Option 2: Leave blank. See remark 7.
MOVERN	ALE mesh automatic motion option (see Remark 8): EQ.0: ALE mesh is fixed in space. GT.0: Node group id. See *ALE_REFERENCE_SYSTEM_NODE ALE mesh can be moved with PRTYP=5, mesh motion follows a coordinate system defined by 3 reference nodes.
ZOOM	ALE mesh automatic expansion option (see Remark 9): EQ.0: do not expand ALE mesh EQ.1: Expand/contract ALE mesh by keeping all airbag parts contained within the ALE mesh (equivalent to PRTYP=9).



**Define card 5a and 5b if NZ > 0**

Card 5a            1            2            3            4            5            6            7            8

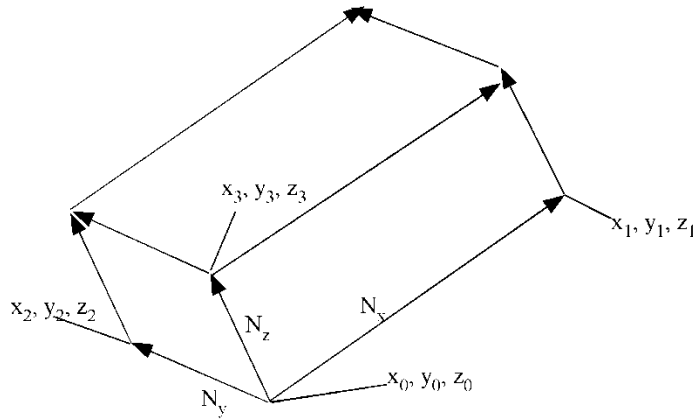
Variable	X0	Y0	Z0	X1	Y1	Z1	IPAIR	IPGAS
Type	F	F	F	F	F	F	I	I
Default	None	None	None	None	None	None	None	None

Card 5b            1            2            3            4            5            6            7            8

Variable	X2	Y2	Z2	Z3	Y3	Z3		
Type	F	F	F	F	F	F		
Default	None	None	None	None	None	None		

**VARIABLE****DESCRIPTION**

X0, Y0, Z0	Coordinates of origin for ALE mesh generation (node0).
X1, Y1, Z1	Coordinates of point 1 for ALE mesh generation (node1). node0=>node1 = x
X2, Y2, Z2	Coordinates of point 2 for ALE mesh generation (node2). node0=>node2 = y
X3, Y3, Z3	Coordinates of point 3 for ALE mesh generation (node3). node0=>node3 = z



**Figure 3.4.**

Card 6            1            2            3            4            5            6            7            8

Variable	SWTIME		HG	NAIR	NGAS	NORIF	LCVEL	LCT
Type	F		F	I	I	I	I	I
Default	0.		0.	0	0	0	0	0
Remarks	3						10	11

**VARIABLE**

**DESCRIPTION**

SWTIME            Time to switch from ALE method to control volume (CV) method. Once switched, a method similar to that used by the \*AIRBAG\_HYBRID card is used.  
                          EQ.0.0: switch to CV method at time=0.0.  
                          EQ.blank: switch time is set at 1.0E16 (ALE method is used).  
                          EQ.t: switch from ALE to CV method at time=t.

HG                   Hourglass control for ALE fluid mesh(es).

NAIR                Number of Air components. For example, this equals 2 in case air contains 80% of N2 and 20% of O2. If air is defined as 1 single gas then NAIR=1.

NGAS                Number of inflator Gas components.

<u>VARIABLE</u>	<u>DESCRIPTION</u>
NORIF	Number of point sources or orifices (defined below) EQ.n: will require n lines of card 9 definitions below, one for each point source.
LCVEL	Load curve ID for inlet velocity (see also TNKVOL & TNKFINP of card 2 above). This is the same estimated velocity curve used in *SECTION_POINT_SOURCE_MIXTURE card.
LCT	Load curve ID for inlet gas temperature (see *AIRBAG_HYBRID).

**Define NAIR cards below for air component**

Card 7            1            2            3            4            5            6            7            8

Variable				MWAIR	INITM	AIRA	AIRB	AIRC
Type				F	F	F	F	F
Default				0	0	0	0.	0.
Remarks						12	12	12

<u>VARIABLE</u>	<u>DESCRIPTION</u>
MWAIR	Molecular weight of air component
INITA	Initial Mass Fraction of Air component(s)
AIRA	First Coefficient of molar heat capacity at constant pressure (e.g., J/mole/K, remark 12).
AIRB	Second Coefficient of molar heat capacity at constant pressure (e.g., J/mole/K <sup>2</sup> , remark 12).
AIRC	Third Coefficient of molar heat capacity at constant pressure (e.g., J/mole/K <sup>3</sup> , remark 12).

**Define NGAS cards below for the GAS components**

Cards 8...      1            2            3            4            5            6            7            8

Variable	LCMF			MWGAS		GASA	GASB	GASC
Type	I			F		F	F	F
Default	none			0		0	0.	0.
Remarks	11					12	12	12

<u>VARIABLE</u>	<u>DESCRIPTION</u>
LCMF	Load curve ID for mass flow rate (see *AIRBAG_HYBRID, e.g., kg/s).
MWGAS	Molecular weight of inflator gas components.
GASA	First Coefficient of molar heat capacity at constant pressure (e.g., J/mole/K, remark 12).
GASB	Second Coefficient of molar heat capacity at constant pressure (e.g., J/mole/K <sup>2</sup> , remark 12).
GASC	Third Coefficient of molar heat capacity at constant pressure (e.g., J/mole/K <sup>3</sup> , remark 12).

**Define NORIF cards below for each point source**

Cards 9...      1            2            3            4            5            6            7            8

Variable	NODEID	VECID	ORIFARE					
Type	I	I	I					
Default	0	0	0					

<u>VARIABLE</u>	<u>DESCRIPTION</u>
NODEID	The node ID defining the point source.

---

<u>VARIABLE</u>	<u>DESCRIPTION</u>
VECID	The vector ID defining the direction of flow at the point source.
ORIFARE	The orifice area at the point source.

**Remarks:**

1. This set ID typically contains the Lagrangian segments of the 3 parts that are coupled to the inflator gas: airbag, airbag canister (compartment), inflator. As in all control-volume, orientation of elements representing bag and canister should point outward. During the ALE phase the segment normal will be reversed automatically for fluid-structure coupling. However, the orientation of inflator element normal vectors should point to its center. See Figure 3.5.
2. Atmospheric density for the ambient gas (air) can be computed from  $\rho_{amb} = P_{amb} / (R * T_{amb})$
3. Since ALL ALE related activities will be turned off after the switch from ALE method to control-volume method, no other ALE coupling will exist beyond t=SWTIME.
4. Vent definition will be used for ALE venting. Upon switching area of the segments will be used for venting as a23 in \*AIRBAG\_HYBRID.
5. Fabric porosity for ALE and \*AIRBAG\_HYBRID can be defined on MAT\_FABRIC. Define FLC and FAC on \*MAT\_FABRIC. FVOPT 7 and 8 will be used for both ALE and \*AIRBAG\_HYBRID. IBLOCK=0 will use FVOPT=7 and IBLOCK=1 will use FVOPT=8.
6. VCOF will be used to scale the vent area for ALE venting and this coefficient will be used as vent coefficient c23 for \*AIRBAG\_HYBRID upon switching.
7. If Nz, Ny and Nz are defined (option 1), card 5a and card 5b should be defined to let LS-DYNA generate the mesh for ALE. Alternatively if Nz is 0 (option 2), then Nx=IDAIR and Ny=IDGAS. In the later case the user need to supply the ALE mesh whose PID=IDAIR.
8. If the airbag moves with the vehicle, set MOVERN=GROUPID, this GROUPID is defined using \*ALE\_REFERENCE\_SYSTEM\_NODE. The 3 nodes defined in ALE\_REFERENCE\_SYSTEM\_NODE will be used to transform the ALE mesh. The point sources will also follow this motion. This simulates PRTYP=5 in the \*ALE\_REFERENCE\_SYSTEM\_GROUP card.
9. Automatic expansion/contraction of the ALE mesh to follow the airbag expansion can be turned on by setting zoom=1. This feature is particularly useful for fully folded airbags requiring very fine ale mesh initially. As the airbag inflates the ale mesh will be

automatically scaled such that the airbag will be contained within the ALE mesh. This simulates PRTYP=9 in the \*ALE\_REFERENCE\_SYSTEM\_GROUP card.

10. There are 3 methods for defining the inlet gas velocity:  
**Option 1:** define LCVEL = 0 → TNKVOL = Tank volume, and TNKFINP = Tank final pressure from tank test data. Inlet gas velocity is estimated by LSDYNA method (testing).  
**Option 2:** define LCVEL = 0 → TNKVOL = inflator can volume, and TNKFINP = blank. Inlet gas velocity is estimated automatically by Lian-Bhalsod-Olovsson method.  
**Option 3:** define LCVEL = n → TNKVOL = 0, and TNKFINP = 0. Inlet gas velocity is defined by user via a load curve ID = n.
11. LCT and LCIDM should have the same number of sampling points.
12. The per-mass-unit, temperature-dependent, constant-pressure heat capacity is

$$C_p(T) = \frac{[A + B * T + C * T^2]}{MW} \sim \frac{J}{kg * K}$$

$$A = \tilde{C}_{p0} \sim J / (\text{mole} * K)$$

$$B \sim J / (\text{mole} * K^2)$$

$$C \sim J / (\text{mole} * K^3)$$

The units shown are only for demonstration of the equation.

13. Sometimes CTYPE=6 may be used for complex folded airbag. NQUAD=2 may be used as a starting value and increase as necessary depending on the relative mesh resolutions of the Lagrangian and ALE meshes.
14. Use a load curve for PFAC whenever possible. It tends to be more robust.

```

*AIRBAG_ALE → {
    AIR → {
        *PART (AMMG2)
        *SECTION_SOLID
        *MAT_GAS_MIXTURE
    }
    GAS → {
        *PART (AMMG1)
        *SECTION_POINT_SOURCE_MIXTURE
        *MAT_GAS_MIXTURE
    }
    Couplings → *CONSTRAINED_LAGRANGE_IN_SOLID
    ALE Mesh motion → *ALE_REFERENCE_SYSTEM_GROUP
    CV → *AIRBAG_HYBRID
    VENT → Venting Definitions
}
    
```

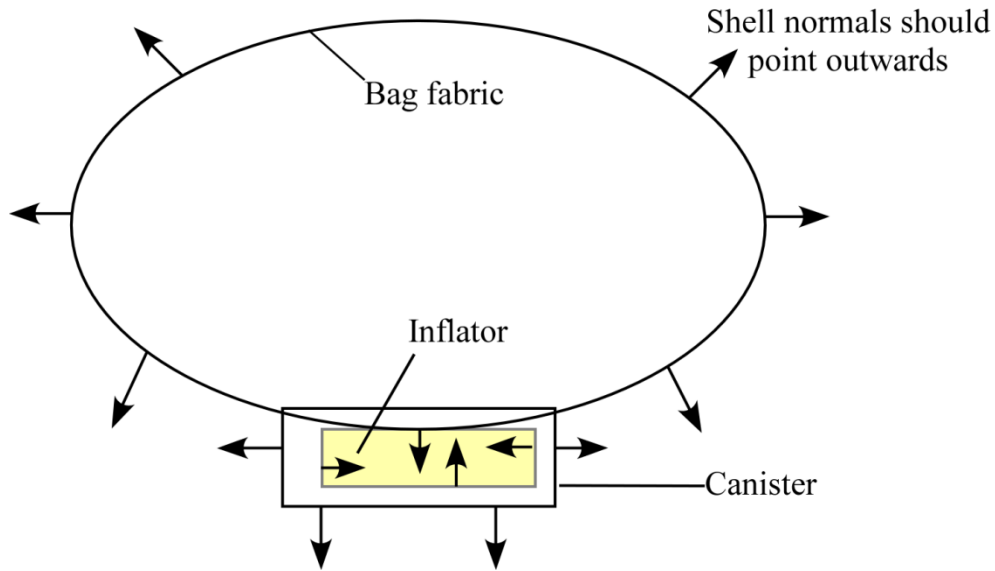


Figure 3.5.

**Example 1:**

```

$. . . | . . . 1 . . . | . . . 2 . . . | . . . 3 . . . | . . . 4 . . . | . . . 5 . . . | . . . 6 . . . | . . . 7 . . . | . . . 8
*AIRBAG_ALE
$#1  SID  SIDTYPE  NONE  NONE  NONE  NONE  MWD  SPSF
     123    1         0      0      0      0      0.0  0.0
$#2  ATMOST  ATMOSP  NONE  GC    CC    TNKVOL  TNKFP
     298.15 1.0132E-4  0      8.314  0.0  0.0      0.0
$#3  NQUAD  CTYPE   PFAC  FRIC  FRCMIN  NORMTYPE  ILEAK  PLEAK
     4      4       -1000  0.0  0.3    0         2      0.1
$#4  VSETID  IVSETTYP  IBLOCK  VENTCOEF
     1      2         0        1.00
$#5  NXIDAIR  NYIDGAS  NZ  MOVERN  ZOOM
     50000    50003    0    0        0
$#6  SWTIME   NONE     HG  NAIR  NGAS  NORIF  LCVEL  LCT
     1000.00  0.000   1.e-4  1    1    8     2002  2001
    
```

# \*AIRBAG

# \*AIRBAG\_ALE

```

$#7 AIR      NONE      NONE      MWAIR      INITM      AIRA      AIRB      AIRC
      0          0          0      0.02897    1.00     29.100    0.00000    0.00000
$#8 GASLCM   NONE      NONE      MWGAS      NONE      GASA      GASB      GASC
      2003       0          0      0.0235     0        28.000    0.00000    0.00000
$#9 NODEID   VECTID   ORIFAREA
      100019     1 13.500000
      100020     2 13.500000
      100021     3 13.500000
      100022     4 13.500000
      100023     5 13.500000
      100024     6 13.500000
      100017     7 13.500000
      100018     8 13.500000
$ PFAC CURVE = penalty factor curve.
*DEFINE_CURVE
$      lcid      sidr      sfa      sfo      offa      offo      dattyp
      1000       0          0.0      2.0      0.0      0.0
$
      a1          o1
      0.0          0.00000000
      1.0000000    4.013000e-04
*SET_SEGMENT_TITLE
vent segments (defined in IVSETID)
      1          0.0      0.0      0.0      0.0
      1735      1736      661      1697      0.0      0.0      0.0      0.0
      1735      2337      1993      1736      0.0      0.0      0.0      0.0
      1735      1969      1988      2337      0.0      0.0      0.0      0.0
      1735      1697      656      1969      0.0      0.0      0.0      0.0
*DEFINE_VECTOR
$#      vid      xt      yt      zt      xh      yh      zh
      1          0.0      0.0-16.250000 21.213200 21.213200-16.250000
      2          0.0      0.0-16.250000 30.000000-1.000e-06-16.250000
      3          0.0      0.0-16.250000 21.213200-21.213200-16.250000
      4          0.0      0.0-16.250000-1.000e-06-30.000000-16.250000
      5          0.0      0.0-16.250000-21.213200-21.213200-16.250000
      6          0.0      0.0-16.250000-30.0000001.000e-06-16.250000
      7          0.0      0.0-16.250000-21.213200 21.213200-16.250000
      8          0.0      0.0-16.2500001.000e-06 30.000000-16.250000
$...|...1...|...2...|...3...|...4...|...5...|...6...|...7...|...8

```

In this example, pre-existing background air mesh with part ID 50000 and gas mesh with part ID 50003 are used. Thus NZ = 0. There is no mesh motion nor expansion allowed. An inlet gas velocity curve is provided.

## Example 2:

```

$...|...1...|...2...|...3...|...4...|...5...|...6...|...7...|...8
$ SIDTYP: 0=SGSID; 1=PSID
*AIRBAG_ALE
$#1      SID      SIDTYPE      NONE      NONE      NONE      NONE      MWD      SPSF
      1          1          0          0.      0.      0.      0.      0.
$#2 ATMOST   ATMOSP      NONE      GC      CC      TNKVOL      TNKFP
      298.      101325.      0.0      8.314    1.      6.0E-5    0
$#3 NQUAD    CTYP      PFAC      FRIC      FRCMIN   NORMTYPE      ILEAK      PLEAK
      2          6          -321      0.0      0.3      1          2          0.1
$#4 VSETID   IVSETTYP   IBLOCK   VENTCOEF
      0          0          0          0
$#5NXIDAIR   NYIDGAS   NZ      MOVERN      ZOOM
      11         11         9
$5b      x0          y0          z0          x1          y1          z1      NOT-USED  NOT-USED
      -0.3       -0.3       -0.135     0.3        -0.3       -0.135

```



```

$5c      x2          y2          z2          x3          y3          z3  NOT-USED  NOT-USED
        -0.3         0.3        -0.135       -0.3         -0.3         0.39
$#6 SWTIME  NONE      HG        NAIR        NGAS        NORIF        LCVEL        LCT
        0.04000      0.005      1.e-4        2            1            1            0            2
$#7 AIR      NONE      NONE      MWAIR      INITM      AIRA        AIRB        AIRC
                                0.028       0.80       27.296     0.00523
                                0.032       0.20       25.723     0.01298
$#8 GASLCM  NONE      NONE      MWGAS      NONE      GASA        GASB        GASC
        1                                0.0249     29.680     0.00880
$#9 NODEID  VECTID  ORIFAREA
        9272      1      1.00e-4
$ Lagrangian shell structure to be coupled to the inflator gas
*SET_PART_LIST
        1          0.0          0.0          0.0          0.0
        1          2          3
*DEFINE VECTOR
$0.100000E+01, 10.000000000
$      vid      xt      yt      zt      xh      yh      zh
        1          0.0      0.0      0.0      0.0      0.0  0.100000
$ bag penetration ~ 1 mm <====> P_coup ~ 500000 pascal ==> ~ 5 atm
*DEFINE_CURVE
$      lcid      sidr      sfa      sfo      offa      offo      dattyp
        321          0          0.0      0.0      0.0      0.0
$
          a1          o1
          0.0          0.0
          0.00100000      5.0000000e+05
$...|...1...|...2...|...3...|...4...|...5...|...6...|...7...|...8

```

In this example, LS-DYNA automatically creates the background ALE mesh with:  
 NX = 11 elements in the x direction.  
 NY = 11 elements in the y direction.  
 NZ = 9 elements in the z direction.

**\*AIRBAG\_INTERACTION**

Purpose: To define two connected airbags which vent into each other.

**Define one card for each airbag interaction definition**

Card            1            2            3            4            5            6            7            8

Variable	AB1	AB2	AREA	SF	PID	LCID	IFLOW	
Type	I	I	F	F	I	I	I	
Default	none	none	none	none	0	0	0	

**VARIABLE****DESCRIPTION**

AB1	First airbag ID, as defined on *AIRBAG card.
AB2	Second airbag ID, as defined on *AIRBAG card.
AREA	Orifice area between connected bags. LT.0.0:  AREA  is the load curve ID defining the orifice area as a function of absolute pressure. EQ.0.0: AREA is taken as the surface area of the part ID defined below.
SF	Shape factor. LT.0.0:  SF  is the load curve ID defining vent orifice coefficient as a function of relative time.
PID	Optional part ID of the partition between the interacting control volumes. AREA is based on this part ID.
LCID	Load curve ID defining mass flow rate versus pressure difference, see *DEFINE_CURVE. If LCID is defined AREA, SF and PID are ignored.
IFLOW	Flow direction LT.0: One way flow from AB1 to AB2 only. EQ.0: Two way flow between AB1 and AB2. GT.0: One way flow from AB2 to AB1 only.

**Remarks:**

Mass flow rate and temperature load curves for the secondary chambers must be defined as null curves, for example, in the DEFINE\_CURVE definitions give two points (0.0,0.0) and (10000.,0.0).

All input options are valid for the following airbag types:

- \*AIRBAG\_SIMPLE\_AIRBAG\_MODEL
- \*AIRBAG\_WANG\_NEFSKE
- \*AIRBAG\_WANG\_NEFSKE\_JETTING
- \*AIRBAG\_WANG\_NEFSKE\_MULTIPLE\_JETTING
- \*AIRBAG\_HYBRID
- \*AIRBAG\_HYBRID\_JETTING

The LCID defining mass flow rate vs. pressure difference may additionally be used with:

- \*AIRBAG\_LOAD\_CURVE
- \*AIRBAG\_LINEAR\_FLUID

If the AREA, SF, and PID defined method is used to define the interaction then the airbags must contain the same gas, i.e.  $C_p$ ,  $C_v$  and  $g$  must be the same. The flow between bags is governed by formulas which are similar to those of Wang-Nefske.



Card 2            1            2            3            4            5            6            7            8

Variable	NP	UNIT	VISFLG	TATM	PATM	NVENT	TEND	TSW
Type	F	I	I	F	F	I	F	F
Default	200,000	0	0	293K	1 atm	0	1.0E+10	1.0E+10

Card 3            1            2            3            4            5            6            7            8

Variable	IAIR	NGAS	NORIF	NID1	NID2	NID3	CHM	CD_EXT
Type	I	I	I	I	I	I	I	F
Default	0	none	none	0	0	0	none	0.

**Optional Cards if STYPE2=2 – Define SID2 cards, one for each internal part or part set.**

Optional        1            2            3            4            5            6            7            8

Variable	SIDUP	STYUP	PFRAC	LINKING				
Type	I	I	F	I				
Default	none	none	0.	none				

**Optional Cards if NPDATA>0 – Define NPDATA cards, one for each heat convection part or part set.**

Optional      1            2            3            4            5            6            7            8

Variable	SIDH	STYPEH	H	PFRIC	SDFBLK			
Type	I	I	F	F	F			
Default	none	none	none	none	1.0			

**Optional Cards if NVENT>0 – Define NVENT cards, one for vent hole.**

Optional      1            2            3            4            5            6            7            8

Variable	SID3	STYPE3	C23	LCTC23	LCPC23	ENH_V	PPOP	
Type	I	I	I	I	I	I	F	
Default	0	none	none	0	0	0	0.0	

**Optional Cards if IAIR > 0**

Optional	1	2	3	4	5	6	7	8
Variable	PAIR	TAIR	XMAIR	AAIR	BAIR	CAIR	NP_AIR	NP_REL AX
Type	F	F	F	F	F	F	I	I
Default	PATM	TATM	none	none	0.0	0.0	0	0

**NGAS Cards (i=1,2,...,n)**

Optional      1            2            3            4            5            6            7            8

Variable	LCMi	LCTi	XMi	Ai	Bi	Ci	INFGi	
Type	I	I	F	F	F	F	I	
Default	none	none	none	none	0.0	0.0	1	

**NORIF Cards (i=1,2,...,n)**

Optional      1            2            3            4            5            6            7            8

Variable	NIDi	ANi	VDi	CAi	INFOi	IMOM	IANG	CHM_ID
Type	I	F	I	F	I	I	I	I
Default	none	none	none	30 Deg	1	0	0	0

**VARIABLE****DESCRIPTION**

SID1	Part or part set ID defining the complete airbag.
STYPE1	Set type: EQ.0: Part EQ.1: Part set
SID2	Part or part set ID defining the internal parts of the airbag.
STYPE2	Set type: EQ.0: Part EQ.1: Part set EQ.2: Number of parts to read (Not recommended for general use)
BLOCK	Blocking. (See remark 4) EQ.0: Off EQ.1: On EQ.10: Off, allow particle escape from exterior holes EQ.11: On, allow particle escape from exterior holes
NPDATA	Number of parts or part sets data.

---

<b>VARIABLE</b>	<b>DESCRIPTION</b>
FRIC	Friction factor. (Default =0.0, see remark 3)
IRDP	Dynamic scaling of particle radius (Development source only) EQ.0: Off EQ.1: On
NP	Number of particles. (Default =200,000)
UNIT	Unit system: EQ.0: kg-mm-ms-K EQ.1: SI EQ.2: tonne-mm-s-K
VISFLG	Visible particles. (only support CPM database, see remark 6) EQ.0: Default to 1 EQ.1: Output particle's coordinates, velocities, mass, radius, spin energy, translational energy EQ.2: Output reduce data set with coordinates only EQ.3: Suppress CPM database
TATM	Atmospheric temperature. (Default =293K)
PATM	Atmospheric pressure. (Default=1 ATM)
NVENT	Number of vent hole parts or part sets
TEND	Time when all (NP) particles have entered bag. (Default=1.0E+10)
TSW	Time for switch to control volume calculation. (Default=1.0E+10)
IAIR	Initial gas inside bag considered: EQ.0: No EQ.1: Yes (using control volume method) EQ.2: Yes (using particle method)
NGAS	Number of gas components
NORIF	Number of orifices
NID1-NID3	Three nodes defining a moving coordinate system for the direction of flow through the gas inlet nozzles (Default=fixed system)
CHM	Chamber ID used in *DEFINE_CPM_CHAMBER. (See remark 8)



---

<u>VARIABLE</u>	<u>DESCRIPTION</u>
CD_EXT	Drag coefficient for external air. If the value is not zero, the inertial effect from external air will be considered and forces will be applied in the normal direction on the exterior airbag surface.
SIDUP	Part or part set ID defining the internal parts that pressure will be applied to. This internal structure acts as a valve to control the external vent hole area. Pressure will be applied only after switch to UP (uniform pressure) using TSW.
STYUP	Set type: EQ.0: Part EQ.1: Part set
PFRAC	Fraction of pressure to be applied to the set (0.0 to 1.0). If PFRAC=0, no pressure is applied to internal parts.
LINKING	Part ID of an internal part that is coupled to the external vent definition. The minimum area of this part or the vent hole will be used for actual venting area.
SIDH	Part or part set ID defining part data.
STYPEH	Set type: EQ.0: Part EQ.1: Part set
H	Heat convection coefficient used to calculate heat loss from the airbag external surface to ambient (W//Km2). See *AIRBAG_HYBRID developments (Resp. P.O. Marklund).
PFRIC	Friction factor.(Default is FRIC from 1 <sup>st</sup> card 7 <sup>th</sup> field).
SDFBLK	Scale down factor for blockage factor (Default=1, no scale down). The valid factor will be (0,1]. If 0, it will set to 1.
SID3	Part or part set ID defining vent holes.
STYPE3	Set type: EQ.0: Part EQ.1: Part set
C23	Vent hole coefficient, a parameter of Wang-Nefske leakage. (Default=1.0, see remark 1)
LCTC23	Load curve defining vent hole coefficient as a function of time. (See remarks 1 and 2)

---

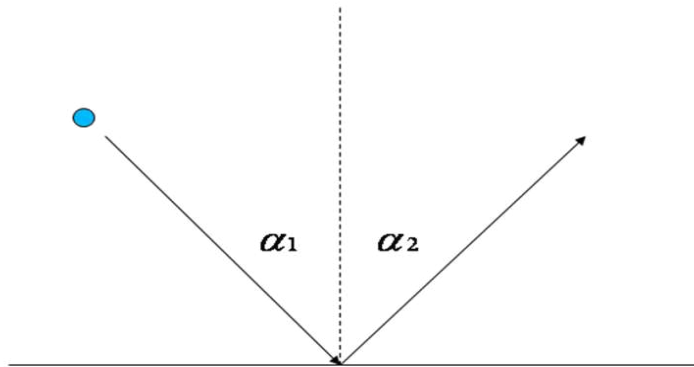
<b>VARIABLE</b>	<b>DESCRIPTION</b>
LCPC23	Load curve defining vent hole coefficient as a function of pressure. (See remarks 1 and 2)
ENH_V	Enhanced venting option. (See remark 10) EQ.0: Off (default) EQ.1: On
PPOP	Pressure difference between interior and ambient pressure (PATM) to open the vent holes. Once the vents are open, they will stay open.
PAIR	Initial pressure inside bag. (Default PAIR=PATM)
TAIR	Initial temperature inside bag. (Default, TAIR=TATM)
XMAIR	Molar mass of gas initially inside bag.
AAIR-CAIR	Constant, linear, and quadratic heat capacity parameters.
NP_AIR	Number of particle for air. (See remark 7)
NP_RELAX	Number of cycles to reach thermal equilibrium. (See remark 7) LT.0: If more than 50% of the collision to fabric is from initial air particle, the contact force will not apply to the fabric segment in order to keep its original shape.
LCMi	Mass flow rate curve for gas component i.
LCTi	Temperature curve for gas component i.
XMi	Molar mass of gas component i.
Ai-Ci	Constant, linear, and quadratic heat capacity parameters for gas component i.
INFGi	Inflator ID for this gas component. (Default=1)
NIDi	Node ID defining the location of nozzle i.
ANi	Area of nozzle i. (Default: all nozzles are assigned the same area)
VDi	Vector ID. (Initial direction of gas inflow at nozzle i)
CAi	Cone angle in degrees. (Default=30 degrees) This option is obsolete in the R4 release.
INFOi	Inflator ID for this orifice. (Default=1)

VARIABLE	DESCRIPTION
IMOM	Inflator reaction force (R5.1.1 release and later). EQ.0: Off EQ.1: On
IANG	Activation for cone angle to use for friction calibration (not normally used; eliminates thermal energy of particles from inflator). EQ.0: Off (Default) EQ.1: On
CHM_ID	Chamber ID where the inflator node resides. (See remark 9)

### Remarks

1. Total vent hole coefficient =  $C23 \cdot LCTC23 \cdot LCPC23$ .
2. If not specified, a constant value of 1.0 is assumed.
3. Friction factor to simulate the surface roughness

Frictionless  $\alpha_1 = \alpha_2$



Friction :

$0 \leq F_r \leq 1$  : Surface Roughness Factor, Rebounding angle

$$F_r = 0; \alpha = \alpha_1 + \alpha_2$$

$$F_r = 1; \alpha = 0$$

$$-1 \leq F_r < 0; \alpha = 2[\alpha_1 - F_r(\frac{\pi}{4} - \frac{\alpha_1}{2})]$$

4. Total fabric porosity coefficient.  
BLOCK=0: coefficient =  $FLC \cdot FAC$   
BLOCK=1: coefficient =  $FLC \cdot FAC \cdot [(1 - \text{blockage}) + ELA(\text{blockage})]$

5.  $dE/dt = A \cdot H \cdot (T_{bag} - T_{atm})$   
A is part area  
H is user defined heat convection coefficient  
T<sub>bag</sub> is weighted average temperature of the particles impacting the part  
T<sub>atm</sub> is ambient temperature
6. Particle time history data is always output to d3plot database now. Lsprepost 2.3 and above can display and fringe those data. In order to reduce runtime memory requirement, option VISFLG should set to 0 (disable).
7. Total number of particles used in each card is NP + NP\_AIR. Since the initial air particles are placed at the surface of the airbag segments with correct velocity distribution initially, particles are not randomly distributed in space. It requires a finite number of relaxation cycles, NP\_RELAX, to allow particles to move and produce better spatial distribution.
8. By default initial air particles will be evenly placed on airbag segments which cannot sense the local volume. This will create incorrect pressure field if the bag has several distinct pockets. \*DEFINE\_CPM\_CHAMBER allows the user to initialize air particles by volume ratios of regions of airbag. The particles will be distributed proportional to the defined chamber volume to achieve better pressure distribution.
9. Chambers and chamber IDs are defined using \*DEFINE\_CPM\_CHAMBER.
10. When enhanced venting is on, the vent hole's equivalent radius (R\_eq) will be calculated. Particles within R\_eq on the high pressure side from the vent hole geometry center will be moved toward the hole. This will increase the collision frequency near the vent for particles to detect small structural features and produce better flow through the vent hole.

**\*AIRBAG\_REFERENCE\_GEOMETRY\_{OPTION}\_{OPTION}**

Available options include:

**<BLANK>****BIRTH****RDT**

The reference geometry becomes active at time BIRTH. Until this time the input geometry is used to inflate the airbag. Until the birth time is reached the actual geometry is used to determine the time step size even if RDT is active.

If RDT is active the time step size will be based on the reference geometry once the solution time exceeds the birth time. This option is useful for shrunken bags where the bag does not carry compressive loads and the elements can freely expand before stresses develop. If this option is not specified, the time step size will be based on the current configuration and will increase as the area of the elements increase. The default may be much more expensive but possibly more stable.

Purpose: If the reference configuration of the airbag is taken as the folded configuration, the geometrical accuracy of the deployed bag will be affected by both the stretching and the compression of elements during the folding process. Such element distortions are very difficult to avoid in a folded bag. By reading in a reference configuration such as the final unstretched configuration of a deployed bag, any distortions in the initial geometry of the folded bag will have no effect on the final geometry of the inflated bag. This is because the stresses depend only on the deformation gradient matrix:

$$F_{ij} = \frac{\partial x_i}{\partial X_j}$$

where the choice of  $X_j$  may coincide with the folded or unfold configurations. It is this unfolded configuration which may be specified here.

Note that a reference geometry which is smaller than the initial airbag geometry will not induce initial tensile stresses.

If a liner is included and the parameter LNRC set to 1 in \*MAT\_FABRIC, compression is disabled in the liner until the reference geometry is reached, i.e., the fabric element becomes tensile.

**Define the follow card if and only if the option BIRTH is specified in the keyword.**

Card            1            2            3            4            5            6            7            8

Variable	BIRTH								
Type	F								
Default	0.0								

**Card Format (I8,3E16.0) The next “\*” keyword card terminates this input.**

Card 2,...        1        2        3        4        5        6        7        8        9        10

Variable	NID	X	Y	Z					
Type	I	F	F	F					
Default	none	0.	0.	0.					
Remarks									

<u>VARIABLE</u>	<u>DESCRIPTION</u>
BIRTH	Time at which the reference geometry activates (default=0.0)
NID	Node ID for which a reference configuration is defined. Nodes defined in this section must also appear under the *NODE input. It is only necessary to define the reference coordinates of nodal points, if their coordinates are different than those defined in the *NODE section.
X	x coordinate
Y	y coordinate
Z	z coordinate

**\*AIRBAG\_SHELL\_REFERENCE\_GEOMETRY**

Purpose: Usually, the input in this section is not needed; however, sometimes it is convenient to use disjoint pre-cut airbag parts to define the reference geometries. If the reference geometry is based only on nodal input, this is not possible since in the assembled airbag the boundary nodes are merged between parts. By including the shell connectivity with the reference geometry, the reference geometry can be based on the pre-cut airbag parts instead of the assembled airbag. The elements, which are defined in this section, must have identical element ID's as those defined in the \*ELEMENT\_SHELL input, but the nodal ID's, which may be unique, are only used for the reference geometry. These nodes are defined in the \*NODE section, but can also be additionally defined above under \*AIRBAG\_REFERENCE\_GEOMETRY. The element orientation and n1-n4 ordering must be identical to the \*ELEMENT\_SHELL input.

Card 1                    1            2            3            4            5            6            7            8            9            10

Variable	EID	PID	N1	N2	N3	N4				
Type	I	I	I	I	I	I				
Default	none	none	none	none	none	none				
Remarks			3	3	3	3				

<u>VARIABLE</u>	<u>DESCRIPTION</u>
EID	Element ID
PID	Optional part ID, see *PART, the part ID is not used in this section.
N1	Nodal point 1
N2	Nodal point 2
N3	Nodal point 3
N4	Nodal point 4





# **\*ALE**

The keyword **\*ALE** provides a way of defining input data pertaining to the Arbitrary-Lagrangian-Eulerian capability. The keyword cards in this section are defined in alphabetical order:

- \*ALE\_AMBIENT\_HYDROSTATIC**
- \*ALE\_FAIL\_SWITCH\_MMG**
- \*ALE\_FRAGMENTATION**
- \*ALE\_FSI\_PROJECTION**
- \*ALE\_FSI\_SWITCH\_MMG\_{OPTION}**
- \*ALE\_MULTI-MATERIAL\_GROUP**
- \*ALE\_REFERENCE\_SYSTEM\_CURVE**
- \*ALE\_REFERENCE\_SYSTEM\_GROUP**
- \*ALE\_REFERENCE\_SYSTEM\_NODE**
- \*ALE\_REFERENCE\_SYSTEM\_SWITCH**
- \*ALE\_REFINE**
- \*ALE\_SMOOTHING**
- \*ALE\_TANK\_TEST**
- \*ALE\_UP\_SWITCH**

For other input information related to the ALE capability, see keywords:

- \*ALE\_TANK\_TEST**
- \*BOUNDARY\_AMBIENT\_EOS**
- \*CONSTRAINED\_EULER\_IN\_EULER**
- \*CONSTRAINED\_LAGRANGE\_IN\_SOLID**
- \*CONTROL\_ALE**
- \*DATABASE\_FSI**
- \*INITIAL\_VOID**
- \*INITIAL\_VOLUME\_FRACTION**
- \*INITIAL\_VOLUME\_FRACTION\_GEOMETRY**
- \*SECTION\_SOLID**
- \*SECTION\_POINT\_SOURCE** (for gas only)
- \*SECTION\_POINT\_SOURCE\_MIXTURE**
- \*SET\_MULTI-MATERIAL\_GROUP\_LIST**
- \*CONSTRAINED\_EULER\_IN\_EULER**

## **\*ALE**

---

<b>SINGLE GASEOUS MATERIAL</b>	<b>MULTIPLE GASEOUS MATERIAL</b>
*EOS_LINEAR_POLYNOMIAL *EOS_IDEAL_GAS *MAT_NULL	*MAT_GAS_MIXTURE *INITIAL_GAS_MIXTURE

**\*ALE\_AMBIENT\_HYDROSTATIC**

Purpose: When an ALE model contains one or more ambient (or reservoir-type) ALE parts (ELFORM=11 and AET=4), this command may be used to initialize the hydrostatic pressure field in the ambient ALE domain due to gravity. The \*LOAD\_BODY\_(OPTION) keyword must be defined. The associated \*INITIAL\_HYDROSTATIC\_ALE keyword may be used to define a similar initial hydrostatic pressure field for the regular ALE domain (not reservoir-type region).

Card 1            1            2            3            4            5            6            7            8

Variable	ALESID	STYPE	VECID	GRAV	PBASE	RAMPTLC		
Type	I	I	I	I	I	I	I	
Default	0	0	0	0	0	0	0	

Card 2            1            2            3            4            5            6            7            8

Variable	NID	MMGBLO						
Type	F	F						
Default	0.0	1.E+10						

<u>VARIABLE</u>	<u>DESCRIPTION</u>
ALESID	ALESID defines the reservoir-type ALE domain/mesh whose hydrostatic pressure field due to gravity is being initialized by this keyword.
STYPE	ALESID set type EQ.0: Part set ID (PSID), EQ.1: Part ID (PID).
VECID	Vector ID of a vector defining the direction of gravity.
GRAV	Magnitude of the gravitational acceleration (for example, in metric GRAV ~ 9.80665 m/s <sup>2</sup> )

<b>VARIABLE</b>	<b>DESCRIPTION</b>
PBASE	Nominal or reference pressure at the top surface of all fluid layers. By convention, the gravity direction points from the top layer to the bottom layer. Each fluid layer must be represented by an ALE multi-material group ID (AMMGID or MMG). . Please see remark 1.
RAMPTLC	A ramping time function load curve ID. This curve (via *DEFINE_CURVE) defines how gravity is ramped up as a function of time. Given GRAV value above, the curve's ordinate varies from 0.0 to 1.0, and its abscissa is the (ramping) time. Please see remark 2.
NID	Node ID defining the top of an ALE fluid (AMMG) layer.
MMGBLO	AMMG ID of the fluid layer immediately below this NID. Each node is defined in association with one AMMG layer below it.

**Remarks:**

1. Assuming a model with multi-layers of ALE fluids, given the pressure at the top surface of the top fluid layer (PBASE), the hydrostatic pressure is computed as following

$$P = P_{base} + \sum_{i=1}^{N_{AMMG-layers}} \rho_i g h_i$$

2. If RAMPTLC is activated (i.e. not equal to "0"), then the hydrostatic pressure is effectively ramped up over a user-defined duration and kept steady. When this load curve is defined, do not define the associated \*INITIAL\_HYDROSTATIC\_ALE card to initialize the hydrostatic pressure for the non-reservoir ALE domain. The hydrostatic pressure in the regular ALE region will be initialized indirectly as a consequence of the hydrostatic pressure generated in the reservoir-type ALE domain. The same load curve should be used to ramp up gravity in a corresponding \*LOAD\_BODY\_(OPTION) card. Via this approach, any submerged Lagrangian structure coupled to the ALE fluids will have time to equilibrate to the proper hydrostatic condition.

**Example:**

Model Summary: Consider a model consisting of 2 ALE parts, air on top of water.

H3 = AMMG1 = Air part above.

H4 = AMMG2 = Water part below.

```

$...|...1...|...2...|...3...|...4...|...5...|...6...|...7...|...8
$ ALE materials (fluids) listed from top to bottom:
$
$ NID AT TOP OF A LAYER SURFACE          ALE MATERIAL LAYER BELOW THIS NODE
$ TOP OF 1st LAYER -----> 1681          -----
$                                         Air above   = PID 3 = H3 = AMMG1 (AET=4)
$                                         -----
$ TOP OF 2nd LAYER -----> 1671          Water below = PID 4 = H4 = AMMG2 (AET=4)
$                                         -----
$ BOTTOM ----->                          -----
$...|...1...|...2...|...3...|...4...|...5...|...6...|...7...|...8
*ALE_AMBIENT_HYDROSTATIC
$  ALESID      STYPE      VECID      GRAV      PBASE      RAMPTLC
$      34         0         11      9.80665    101325.0      9
$  NID      MMGBLO
$      1681         1
$      1671         2
*SET_PART_LIST
$      34
$      3         4
*ALE_MULTI-MATERIAL_GROUP
$      3         1
$      4         1
*DEFINE_VECTOR
$  VID      XT      YT      ZT      XH      YH      ZH      CID
$      11      0.0      1.0      0.0      0.0      0.0      0.0
*DEFINE_CURVE
$      9
$           0.000           0.000
$           0.001           1.000
$           10.000          1.000
*LOAD_BODY_Y
$  LCID      SF      LCIDDR      XC      YC      ZC
$      9      9.80665      0         0.0      0.0      0.0
$...|...1...|...2...|...3...|...4...|...5...|...6...|...7...|...8

```



---

<u>VARIABLE</u>	<u>DESCRIPTION</u>
FR_MMG	This is the AMMG-SID before the switch. The AMMG-SID corresponds to the SID defined under the *SET_MULTI-MATERIAL_GROUP_LIST (SMMGL) card. This SID points to one or more AMMGs. See Remark 1.
TO_MMG	This is the AMMG-SID after the switch. The AMMG-SID corresponds to the SID defined under the *SET_MULTI-MATERIAL_GROUP_LIST card. This SID points to one or more AMMGs. See Remark 1.

**Remarks:**

1. There is a correspondence between the FR\_MMG and TO\_MMG. Consider an example where:
  - a. The FR\_MMG SID points to a SID=12 (the SID of its SMMGL card is 12, and this SID contains AMMG 1 and AMMG 2)
  - b. The TO\_MMG points to a SID=34 (the SID of the SMMGL card is 34, and this SID contains AMMG 3 and AMMG 4)

Then, AMMG 1, if switched, will become AMMG 3, and AMMG 2, if switched, will become AMMG 4.

# \*ALE

# \*ALE\_FSI\_PROJECTION

## \*ALE\_FSI\_PROJECTION

Purpose: This card provides a coupling method for simulating the interaction between a Lagrangian material set (structure) and ALE material set (fluid). The nearest ALE nodes are projected onto the Lagrangian structure surface at each time step. This method does not conserve energy, as mass and momentum are transferred via constrained based approach.

Card 1            1            2            3            4            5            6            7            8

Variable	LAGSID	ALESID	LSIDTYP	ASIDTYP	SMMGID	ICORREC	INORM	
Type	I	I	I	I	I	I	I	
Default	0	0	0	0	0	0	0	

Card 2            1            2            3            4            5            6            7            8

Variable	BIRTH	DEATH						
Type	F	F						
Default	0.0	1.E+10						

### VARIABLE

### DESCRIPTION

LAGSID	A set ID defining the Lagrangian part(s) for this coupling (structures).
ALESID	A set ID defining the ALE part(s) for this coupling (fluids).
LSIDTYP	Lagrangian set ID type EQ.0: Part set ID (PSID), EQ.1: Part ID (PID).
ASIDTYP	ALE set ID type EQ.0: Part set ID (PSID), EQ.1: Part ID (PID).



<u>VARIABLE</u>	<u>DESCRIPTION</u>
SMMGID	A set ID referring to a group of one or more ALE-Multi-Material-Group (AMMG) IDs which represents the ALE materials interacting with the Lagrangian structure. This SMMGID is a set ID defined by *SET_MULTI-MATERIAL_GROUP_LIST.
ICORREC	Advection error correction method (See Remark 1). EQ.1: ALE mass is conserved. Leaked mass is moved, EQ.2: ALE mass is almost conserved, EQ.3: No correction performed (default). ALE mass is conserved. Some leakage may occur. This may be the best solution.
INORM	Type of coupling. EQ.0: Couple in all directions, EQ.1: Couple in compression and tension (free sliding), EQ.2: Couple in compression only (free sliding). This choice requires ICORREC=3.
BIRTH	Start time for coupling.
DEATH	End time for coupling.

**Remarks:**

1. As the ALE nodes are projected onto the closest Lagrangian surface, there may be some advection errors introduced. These errors may result in a small element mass fraction being present on the “wrong” side of the coupled Lagrangian surface. There are 3 possible scenarios:
  - a. Mass on the wrong side of the Lagrangian structure may be moved to the right side. This may cause P oscillations. No leakage will occur.
  - b. Mass on the wrong side is deleted. Mass on the right side is scaled up to compensate for the lost mass. No leakage will occur.
  - c. Mass on the wrong side is allowed (no correction performed). Some leakage may occur. This may be the most robust and simplest approach.

**Example:**

Model Summary:

H1 = AMMG1 = background air mesh.

H2 = AMMG2 = fluid inside container S3.

S3 = cylinder containing AMMG2.

S4 = dummy target cylinder for impact.

The gas inside S3 is AMMG2. S3 is given an initial velocity and it will impact S4.

```
$...|...1...|...2...|...3...|...4...|...5...|...6...|...7...|...8
*ALE_MULTI-MATERIAL_GROUP
    1      1
    2      1
*SET_MULTI-MATERIAL_GROUP_LIST
    22
    2
*ALE_FSI_PROJECTION
$  LAGSID  ALESID  LSIDTYP  ASIDTYP  SMMGID  ICORREC  INORM
    3      1      1      1      22      3      2
$  BIRTH  DEATH
    0.0    20.0
$...|...1...|...2...|...3...|...4...|...5...|...6...|...7...|...8
```

\*ALE\_FRAGMENTATION

Purpose: When a material reaches failure criteria associated with its material model, this card is used to allow the switching from the ALE multi-material-group ID, AMMGID, (FR\_MMG) of this failed material to another AMMGID (TO\_MMG). This feature may typically be used in simulating fragmentation of materials.

Card 1            1            2            3            4            5            6            7            8

Variable	FR_MMG	TO_MMG	FRAGTYP					
Type	I	I	F					
Default	none	none	0.0					

<u>VARIABLE</u>	<u>DESCRIPTION</u>
FR_MMG	This is the AMMGID of the material that just fails, before the switch.
TO_MMG	This is the AMMGID that the failed material is being switched to (please see remark 1).
FRAGTYP	Flag defining the choice of failed material treatment (see remark 1). EQ. 1: Equivalent to the <u>default</u> method where all failed material volume fraction is switched from FR_MMG to TO_MMG. EQ. 2: Only the volume fraction increment that failed is switched from FR_MMG to TO_MMG.

**Remarks:**

1. In a multi-material ALE element, one of the materials may reach failure criteria. The AMMGID of this (original) failed material may be switched to another AMMGID.

Example 1, consider an ALE metal bar (AMMG1) is being stretched to the point of failure. The ALE space surrounding this bar is, say, vacuum (AMMG2). When the AMMG1 volume fraction is detected to fail, it is switched to AMMG2, background vacuum, automatically.

Example 2, if the ALE space surrounding this bar is not vacuum, say, air (AMMG2), then an additional dummy part with \*MAT\_VACUUM (AMMG3) is defined. The failed material volume fraction is switched from AMMG1 to AMMG3 automatically

So examples 1 and 2 above are the traditional or default failed material treatment options, i.e. without the need for this \*ALE\_FRAGMENTATION card.

If the \*ALE\_FRAGMENTATION card is defined and:

FRAGTYP=1, then the treatment is similar to the default treatment, that is, when the FR\_MMG volume fraction is detected to fail, it is switched to TO\_MMG. So the slight difference is the control of the AMMGID of the vacuum material to switch to.

FRAGTYP=2 is an advanced option where when the volume fraction increment is detected to reach failure, only this volume fraction increment is switched from the FR\_MMG to the TO\_MMG. The mass of the failed material is conserved. This is similar to inserting a vacuum gap into the space which if the material is to expand into would fail.

**Example:**

Consider a simple bar extension example:

H5 = AMMG1 = Metal bar = FR\_MMG

H6 = AMMG2 = Air space surrounding the bar = background mesh

H7 = AMMG3 = Dummy vacuum part (material) = TO\_MMG

```

$...|...1...|...2...|...3...|...4...|...5...|...6...|...7...|...8
*ALE_FRAGMENTATION
$  FR_MMG    TO_MMG    FRAGTYP
   1         3         2
$...|...1...|...2...|...3...|...4...|...5...|...6...|...7...|...8

```

\*ALE\_FSI\_SWITCH\_MMG\_{OPTION}

Purpose: This card is used to allow the switching of an ALE multi-material-group ID (AMMGID) of a fluid as that fluid passes across a monitoring surface. This monitoring surface may be a Lagrangian shell structure, or a segment set. It does not have to be included in the slave set of the coupling card (CLIS).

Available options include:

<BLANK>

ID

An ID number (up to 8 digits) may be defined for this switch command in the first 10-character space.

or

TITLE

A title for the card may be input between the 11<sup>th</sup> and 80<sup>th</sup> character on the title-ID line. The optional title line precedes all other cards for this command.

The user can explicitly define a title for this coupling.

Title Card Format

The following card is read if and only if the ID or TITLE option is specified.

Optional 1 2

Variable	ID	TITLE						
Type	I10	A70						

Card 1 1 2 3 4 5 6 7 8

Variable	SID	STYPE	NQUAD	XOFF	BTIME	DTIME	NFREQ	NFOLD
Type	I	I	I	F	F	F	I	I
Default	none	0	1	0.0	0.0	1.0E20	1	0

Card 2            1            2            3            4            5            6            7            8

Variable	FR_MMG	TO_MMG	XLEN					
Type	I	I	F					
Default	none	none	0.0					

**VARIABLE****DESCRIPTION**

SID	A set ID defining a monitoring surface over which an ALE fluid flows across, and its ALE multi-material-group-ID (AMMGID) is switched. The monitoring surface may be a Lagrangian shell structure, or a segment set. This surface, if Lagrangian, does not have to be included in the coupling definition (see remark 4).
STYPE	Set ID type of the above SID. EQ.0: Part set ID (PSID) (default). EQ.1: Part ID (PID). EQ.2: Segment set ID (SGSID).
NQUAD	The number of flow-sensor points to be distributed over each monitoring surface/segment. There should be enough sensor points distributed to monitor the flow in each ALE element intersected by this monitoring surface (default=1, see remark 3).
XOFF	An offset distance away from the monitoring surface, beyond which the AMMGID switching occurs. The direction of XOFF is defined by the normal vector of the monitoring segment. This offset distance, in general, should be at least 2 ALE element widths away from, and beyond the monitoring interface (default=0.0).
BTIME	Start time for the AMMGID switch to be activated (default=0.0).
DTIME	Ending time for the AMMGID switch (default=1.0E20).
NFREQ	Number of computational cycles between ALE switch check (default=1).

---

<u>VARIABLE</u>	<u>DESCRIPTION</u>
NFOLD	Flag for checking folding logic (default=0=off). If NFOLD=1=on, then LS-DYNA will check if the monitoring segment is in the fold, applicable to airbag. If the monitoring segment is still located within a folded (shell) region, then no switching is allowed yet until it has unfolded.
FR_MMG	This is the AMMG-SID before the switch. The AMMG-SID corresponds to the SID defined under the *SET_MULTI-MATERIAL_GROUP_LIST (SMMGL) card. This SID points to one or more AMMGs. See Remark 1.
TO_MMG	This is the AMMG-SID after the switch. The AMMG-SID corresponds to the SID defined under the *SET_MULTI-MATERIAL_GROUP_LIST card. This SID points to one or more AMMGs. See Remark 1.
XLEN	This is an absolute distance for distributing the flow sensor points over the ALE elements. To make sure that at least 1 sensor point, defined on each Lagrangian segment, is present in each ALE element to track the flow of an AMMG, XLEN may be estimated as roughly half the length of the smallest ALE element in the mesh. See Remark 3.

**Remarks:**

1. There is a correspondence between the FR\_MMG and TO\_MMG. Consider an example where:
  - a. The FR\_MMG SID points to a SID=12 (the SID of its SMMGL card is 12, and this SID contains AMMG 1 and AMMG 2)
  - b. The TO\_MMG points to a SID=34 (the SID of the SMMGL card is 34, and this SID contains AMMG 3 and AMMG 4)

Then, AMMG 1, if switched, will become AMMG 3, and AMMG 2, if switched, will become AMMG 4.

2. The ID option must be activated if the parameter SWID is used in the \*DATABAS\_FSI card. Then the accumulated mass of an AMMG that goes through a tracking surface, and being switched, will be reported via the parameter "PLEAK" in the "dbfsi" ASCII output file (or equivalently the "POROSITY" parameter inside LS-Prepost ASCII plotting option).
3. When both NQUAD and XLEN are defined, whichever gives smaller sensor-point interval distance will be used. XLEN may give better control as in the case of a null shell

acting as the monitoring surface. As this null shell is stretched, NQUAD distribution of sensor-points may not be adequate, but XLEN would be.

- The monitoring surface does not have to be included in the slave set of the coupling card. However, at least one coupling card must be present in the model. The monitoring segment set can be made up of Lagrangian or ALE nodes.

**Example:**

Consider a simple airbag model with 3 part IDs:

H25 = AMMG1 = Inflator gas injected into the airbag.

H24 = AMMG2 = Air outside the airbag = background mesh

H26 = AMMG3 = Dummy AMMG of inflator gas after it passes through a vent hole.

S9 = A Lagrangian shell part representing a vent hole.

S1 = A Lagrangian shell part representing the top half of an airbag.

S2 = A Lagrangian shell part representing the bottom half of an airbag.

The inflator gas inside the airbag is distinguished from the inflator gas that has passed through the monitoring surface (vent hole) to the outside of the airbag by assigning different ALE multi-material group set ID to each. The dummy fluid part (H26) should have the same material and EOS model IDs as the before-switched fluid (H25).

Fr\_MMG=1 ==> points to AMMGID=1 ==> points to H25 (inflator gas if inside)

To\_MMG=2 ==> points to AMMGID=3 ==> points to H26 (inflator gas if outside)

```

$. . . | . . . 1 . . . | . . . 2 . . . | . . . 3 . . . | . . . 4 . . . | . . . 5 . . . | . . . 6 . . . | . . . 7 . . . | . . . 8
*ALE_MULTI-MATERIAL_GROUP
    25      1
    24      1
    26      1
*DATABASE_FSI
$   TOUT                                [STYPE: 0=PSID ; 1=PID ; 2=SGSID]
    0.1000
$  DBFSI_ID      SID      STYPE  AMMGSWID  LDCONVID
    1            1        1
    2            2        1
    3            9        1      90000
*SET_MULTI-MATERIAL_GROUP_LIST
    125
    1
*SET_MULTI-MATERIAL_GROUP_LIST
    126
    3
*ALE_FSI_SWITCH_MMG_ID
    90000
$   SID  SIDTYPE  NQUAD   XOFF   BTIME   DTIME   NFREQ   FOLD
    9     1        3   -20.0    5.0     0.0     1       1
$  Fr_MMG  To_MMG  XCLEN
    125    126     5.
$. . . | . . . 1 . . . | . . . 2 . . . | . . . 3 . . . | . . . 4 . . . | . . . 5 . . . | . . . 6 . . . | . . . 7 . . . | . . . 8

```



**Note:**

1. The \*DATABASE\_FSI card tracks 3 surface entities: (a) top half of an airbag, (b) bottom half of an airbag, and (c) the vent hole monitoring surface where the AMMGID of the inflator gas is switched.
2. The amount of mass passing through the vent hole during the switch is output to a parameter called “pleak” in a “dbfsi” ASCII file. See \*DATABASE\_FSI.
3. The \*ALE\_FSI\_SWITCH\_MMG\_ID card track any flow across S9 and switch the AMMGID from 125 (AMMG 1) to 126 (AMMG 3).

**\*ALE\_MULTI-MATERIAL\_GROUP**

Purpose: This command defines the appropriate ALE material groupings for interface reconstruction when many ALE Multi-Material Groups (AMMG) are present in a model. This card is required when ELFORM=11 in the \*SECTION\_SOLID card. This is the ALE Multi-Material element formulation requiring at least 2 ALE materials to be present in a model. Each data line represents 1 ALE multi-material group (AMMG), with the first line referring to group 1, second line group 2, etc. Each AMMG represents one unique “fluid” which may undergo interaction with any Lagrangian structure in the model.

Card                    1                    2                    3                    4                    5                    6                    7                    8

Variable	SID	IDTYPE							
Type	I	I							
Default	none	0							
Remarks	1								

**VARIABLE****DESCRIPTION**

SID	Set ID.
IDTYPE	Set type: EQ.0: Part set, EQ.1: Part.

**Remarks:**

1. When ELFORM=12 in the \*SECTION\_SOLID card (single material and void), this card should not be used. In one model, ELFORM=12 cannot be used together with ELFORM=11. If possible, it is recommended that ELFORM=11 be used as it is the most robust and versatile formulation for treating multi-material ALE parts.
2. Each AMMG is given an ID (AMMGID), and consists of one or more PART ID's. The interface of each AMMGID is reconstructed as it evolves dynamically. Each AMMGID is represented by one material contour color in LS-PREPOST.
3. The maximum number of AMMGIDs allowed has been increased to 20. However, there may be 2, at most 3, AMMGs inside an ALE element at anytime. If there are more than 3

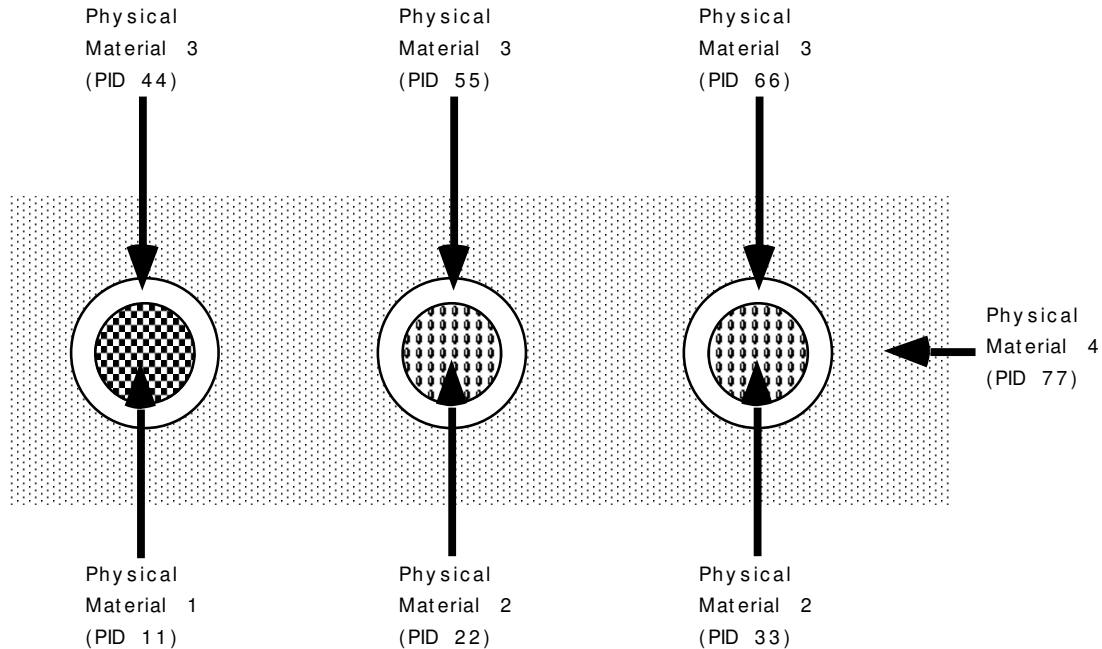
AMMGs inside any 1 ALE element, the ALE mesh needs refinement. Better accuracy is obtained with 2 AMMGs in mixed elements.

4. To plot these AMMGIDs in LS-PREPOST:  
[FCOMP] ⇒ [MISC] ⇒ [VOLUME FRACTION OF AMMGID #] ⇒ [APPLY]  
(Note: Contour definitions maybe different for gas mixture application)
5. It is very important to distinguish among the
  - (a) Physical materials,
  - (b) PART IDs, and
  - (c) AMMGIDs.

A \*PART may be any mesh component. In ALE formulation, it is simply a geometric entity and a time=0 concept. This means a \*PART may be a mesh region that can be filled with one or more AMMGIDs at time zero, via a volume filling command (\*INITIAL\_VOLUME\_FRACTION\_GEOMETRY). An AMMGID represents a physical material group which is treated as one material entity (represented by 1 material color contour in LS-PREPOST plotting). AMMGID is used in dealing with multiple ALE or Eulerian materials. For example, it can be used to specify a master ALE group in a coupling card.

### **Example 1:**

Consider a purely Eulerian model containing 3 containers containing 2 different physical materials (fluids 1 and 2). All surrounded by the background material (maybe air). The containers are made of the same material, say, metal. Assume that these containers explode and spill the fluids. We want to track the flow and possibly mixing of the various materials. Note that all 7 parts have ELFORM=11 in their \*SECTION\_SOLID cards. So we have total of 7 PIDs, but only 4 different physical materials.



**Approach 1:** If we want to track only the interfaces of the physical materials.

```

$. . . | . . . 1 . . . | . . . 2 . . . | . . . 3 . . . | . . . 4 . . . | . . . 5 . . . | . . . 6 . . . | . . . 7 . . . | . . . 8
*SET_PART
  1
  11
*SET_PART
  2
  22      33
*SET_PART
  3
  44      55      66
*SET_PART
  4
  77
*ALE_MULTI-MATERIAL_GROUP
  1      0    <= 1st line = 1st AMMG => AMMGID=1
  2      0    <= 2nd line = 2nd AMMG => AMMGID=2
  3      0    <= 3rd line = 3rd AMMG => AMMGID=3
  4      0    <= 4th line = 4th AMMG => AMMGID=4
$. . . | . . . 1 . . . | . . . 2 . . . | . . . 3 . . . | . . . 4 . . . | . . . 5 . . . | . . . 6 . . . | . . . 7 . . . | . . . 8
    
```

With this approach, we define only 4 AMMGs (NALEGP=4). So in LS-PrePost, when plotting the material-group (history variable) contours, we will see 4 colors, one for each material group. One implication is that when the fluids from part 22 and part 33 flow into the same element, they will coalesce and no boundary distinction between them is maintained subsequently. While this may be acceptable for fluids at similar thermodynamic states, this may not be intuitive for solids. For example, if the solid container materials from parts 44, 55 and 66 flow into one element, they will coalesce “like a single fluid”, and no interfaces among them are tracked. If this is undesirable, an alternate approach may be taken. It is presented next.

**Approach 2:** If we want to reconstruct as many interfaces as necessary, in this case, we follow the interface of each part.

```

$. . . | . . . 1 . . . | . . . 2 . . . | . . . 3 . . . | . . . 4 . . . | . . . 5 . . . | . . . 6 . . . | . . . 7 . . . | . . . 8
*ALE_MULTI-MATERIAL_GROUP
    1      1  <= 1st line = 1st AMMG => AMMGID=1
    2      1  <= 2nd line = 2nd AMMG => AMMGID=2
    3      1  <= 3rd line = 3rd AMMG => AMMGID=3
    4      1  <= 4th line = 4th AMMG => AMMGID=4
    5      1  <= 5th line = 5th AMMG => AMMGID=5
    6      1  <= 6th line = 6th AMMG => AMMGID=6
    7      1  <= 7th line = 7th AMMG => AMMGID=7
$. . . | . . . 1 . . . | . . . 2 . . . | . . . 3 . . . | . . . 4 . . . | . . . 5 . . . | . . . 6 . . . | . . . 7 . . . | . . . 8

```

There are 7 AMMGs in this case (NALEGP=7). This will involve more computational cost for the additional tracking. Realistically, accuracy will be significantly reduced if there are more than 3 or 4 materials in any one element. In that case, higher mesh resolution may be required.

**Example 2:**

OIL	WATER	AIR
GROUP 1	GROUP 2	GROUP 3
PART ID'S 1 AND 2	PART ID 3	PART ID'S 5, 6, AND 7

The above example defines a mixture of three groups of materials (or “fluids”), oil, water and air, that is, the number of ALE multi-material groups (AMMGs) NALEGP=3.

The first group contains two parts (materials), part ID's 1 and 2.

The second group contains one part (material), part ID 3.

The third group contains three parts (materials), part ID's 5, 6 and 7.

# \*ALE

## \*ALE\_REFERENCE\_SYSTEM\_CURVE

### \*ALE\_REFERENCE\_SYSTEM\_CURVE

Purpose: This command defines a motion and/or a deformation prescribed for a geometric entity (where a geometric entity may be any part, part set, node set, or segment set). The motion or deformation may be completely defined by 12 parameters (shown in the equation below). These 12 parameters are defined in terms of 12 load curves. This command is required only when PRTYPE=3 in the \*ALE\_REFERENCE\_SYSTEM\_GROUP (ARSG) command.

Card 1            1            2            3            4            5            6            7            8

Variable	ID							
Type	I							
Default	none							

Card 2            1            2            3            4            5            6            7            8

Variable	LCID1	LCID2	LCID3	LCID4	LCID5	LCID6	LCID7	LCID8
Type	I	I	I	I	I	I	I	I
Default	none	none	none	none	none	none	none	none

Card 3            1            2            3            4            5            6            7            8

Variable	LCID9	LCID10	LCID11	LCID12				
Type	I	I	I	I				
Default	none	none	none	none				

VARIABLE	DESCRIPTION
ID	Curve group ID.
LCID1...LCID12	Load curve ID's.

**Remarks:**

- The velocity of a node at coordinate  $(x, y, z)$  is defined as:

$$\begin{Bmatrix} \dot{x} \\ \dot{y} \\ \dot{z} \end{Bmatrix} = \begin{Bmatrix} f_1 \\ f_5 \\ f_9 \end{Bmatrix} + \begin{bmatrix} f_2 & f_3 & f_4 \\ f_6 & f_7 & f_8 \\ f_{10} & f_{11} & f_{12} \end{bmatrix} \begin{Bmatrix} x \\ y \\ z \end{Bmatrix}$$

$f_1(t)$  is the value of load curve LCID1 at time  $t$  etc. Note that  $f_1(t)$ ,  $f_5(t)$ ,  $f_9(t)$  correspond to the translation components in global x, y, and z direction, respectively.  $f_2(t)$ ,  $f_7(t)$ , and  $f_{12}(t)$  correspond to the expansion or contraction component. The remaining functions give rotation contribution.

**Example 1:**

Consider a motion that consists of translation in the x and y direction only. Thus only  $f_1(t)$  and  $f_5(t)$  are required. Hence only 2 load curve ID's need be defined:

```

$...|...1...|...2...|...3...|...4...|...5...|...6...|...7...|...8
*ALE_REFERENCE_SYSTEM_GROUP
$   SID      STYPE      PRTYP      PRID      BCTRAN      BCEXP      BCROT      ICOORD
$     1         0         3         11         0         7         0
$   XC        YC        ZC      EXPLIM
$     0         0         0         0
*ALE_REFERENCE_SYSTEM_CURVE
$ CURVESID
$     11
$   LCID1     LCID2     LCID3     LCID4     LCID5     LCID6     LCID7     LCID8
$    111         0         0         0         222         0         0         0
$   LCID9     LCID10    LCID11    LCID12
$     0         0         0         0
*DEFINE_CURVE
$   lcid      sidr      sfa      sfo      offa      offo      dattyp
$     111
$           a1           o1
$           0.00         5.0
$           0.15         4.0
*DEFINE_CURVE
$   lcid      sidr      sfa      sfo      offa      offo      dattyp
$     222
$           a1           o1
$           0.00        -1.0
$           0.15        -5.0
$...|...1...|...2...|...3...|...4...|...5...|...6...|...7...|...8

```

**\*ALE\_REFERENCE\_SYSTEM\_GROUP**

Purpose: This card is used to associate a geometric entity to a reference system type. A geometric entity may be any part, part set, node set, or segment set of a model (or a collection of meshes). A reference system type refers to the possible transformation allowed for a geometric entity (or mesh). This command defines the type of reference system or transformation that a geometric entity undergoes. In other words, it prescribes how certain mesh can translate, rotate, expand, contract, or be fixed in space, etc.

Card 1            1            2            3            4            5            6            7            8

Variable	SID	STYPE	PRTYPE	PRID	BCTAN	BCEXP	BCROT	ICR/NID
Type	I	I	I	I	I	I	I	I
Default	none	0	0	0	0	0	0	0

Card 2            1            2            3            4            5            6            7            8

Variable	XC	YC	ZC	EXPLIM	EFAC		FRCPAD	IEXPND
Type	F	F	F	F	F		F	I
Default	0.0	0.0	0.0	inf.	0.0		0.1	0

**Optional**

Card 3            1            2            3            4            5            6            7            8

Variable	IPIDXCL	IPIDTYP						
Type	I	I						
Default	0	0						



VARIABLE	DESCRIPTION
SID	Set ID.
STYPE	Set type: EQ.0: part set, EQ.1: part, EQ.2: node set, EQ.3: segment set.
PRTYPE	Reference system type (See Remark 1 below) EQ.0: Eulerian, EQ.1: Lagrangian, EQ.2: Normal ALE mesh smoothing, EQ.3: Prescribed motion following load curves, see *ALE_REFERENCE_SYSTEM_CURVE, EQ.4: Automatic mesh motion following mass weighted average velocity in ALE mesh, EQ.5: Automatic mesh motion following a local coordinate system defined by three user defined nodes, see *ALE_REFERENCE_SYSTEM_NODE, EQ.6: Switching in time between different reference system types, see *ALE_REFERENCE_SYSTEM_SWITCH, EQ.7: Automatic mesh expansion in order to enclose up to twelve user defined nodes, see *ALE_REFERENCE_SYSTEM_NODE. EQ.8: Mesh smoothing option for shock waves, where the element grid contracts in the vicinity of the shock front. This may be referred to as the Delayed-ALE option. It controls how much the mesh is to be moved during the remap step. This option requires the definition of the 5 <sup>th</sup> parameter in the 2 <sup>nd</sup> card, EFAC; see below for definition. EQ.9: Allowing the ALE mesh(es) to: -Translate and/or rotate to follow a local Lagrangian reference coordinate system (whose *ALE_REFERENCE_SYSTEM_NODE card ID is defined by the <u>BCT</u> parameter) -Expand or contract to enclose a Lagrangian part-set ID defined by the <u>PR</u> parameter. -Has a Lagrangian node ID be defined by the <u>ICR/NID</u> parameter to be the center of the ALE mesh expansion.

---

<b>VARIABLE</b>	<b>DESCRIPTION</b>
PRID	<p>A parameter giving additional information depending on the reference system (PRTYPE) choice:</p> <p>PRTYPE= 3: PRID defines a load curve group ID specifying an *ALE_REFERENCE_SYSTEM_CURVE card for mesh translation. This defines up to 12 curves which prescribe the motion of the system.</p> <p>PRTYPE= 5: PRID defines a node group ID specifying an *ALE_REFERENCE_SYSTEM_NODE card, via which, three nodes forming a local coordinate system are defined.</p> <p>PRTYPE= 6: PRID defines a switch list ID specifying an *ALE_REFERENCE_SYSTEM_SWITCH card. This defines the switch times and the reference system choices for each time interval between the switches.</p> <p>PRTYPE= 7: PRID defines a node group ID specifying an *ALE_REFERENCE_SYSTEM_NODE card. Up to 12 nodes in space forming a region to be enveloped by the ALE mesh are defined.</p> <p>PRTYPE= 9: PRID defines a Lagrangian part set ID (PSID) defining the Lagrangian part(s) whose range of motion is to be enveloped by the ALE mesh(es). This is useful for airbag modeling.</p>
BCTRAN	<p>For PRTYPE 4 &amp; 5: BCTRAN is a translational constraint (remark 3). EQ.0: no constraints, EQ.1: constrained x translation, EQ.2: constrained y translation, EQ.3: constrained z translation, EQ.4: constrained x and y translation, EQ.5: constrained y and z translation, EQ.6: constrained z and x translation, EQ.7: constrained x, y, and z translation.</p> <p>For PRTYPE= 9: BCTRAN defines a node group ID defined by *ALE_REFERENCE_SYSTEM_NODE card prescribing a local coordinate system (3 node IDs) whose motion is to be followed by the ALE mesh(es).</p>

VARIABLE	DESCRIPTION
BCEXP	<p>For PRTYPE= 4 &amp; 7: BCTRAN is an expansion constraint (remark 3).</p> <p>EQ.0: no constraints,            EQ.1: constrained x expansion,            EQ.2: constrained y expansion,            EQ.3: constrained z expansion,            EQ.4: constrained x and y expansion,            EQ.5: constrained y and z expansion,            EQ.6: constrained z and x expansion,            EQ.7: constrained x, y, and z expansion.</p>
BCROT	<p>For PRTYPE= 4: BCROT is a rotational constraint (remark 3).</p> <p>EQ.0: no constraints,            EQ.1: constrained x rotation,            EQ.2: constrained y rotation,            EQ.3: constrained z rotation,            EQ.4: constrained x and y rotation,            EQ.5: constrained y and z rotation,            EQ.6: constrained z and x rotation,            EQ.7: constrained x, y, and z rotation.</p>
ICR/NID	<p>A flag defining the center of mesh expansion and/or rotation (remark 3).</p> <p>PRTYPE=4: <u>ICR</u> is a center of mesh expansion and rotation flag,            EQ.0: The center is at center of gravity of the ALE mesh.            EQ.1: The center is at (XC, YC, ZC), just a point in space (it does not have to be a defined node)</p> <p>PRTYPE=9: <u>NID</u> (node ID) is a Lagrangian NID. LSDYNA uses this node as an anchored center of ALE mesh expansion (remark 2).</p>
XC,YC,ZC	<p>Center of mesh expansion if PRTYPE= 4. This supplements the ICR parameter above.</p>
EXPLIM	<p>Limit ratio for mesh expansion and contraction. Each Cartesian direction is treated separately. The distance between the nodes is not allowed to increase by more than a factor EXPLIM, or decrease to less than a factor 1/EXPLIM. This flag applies only for PRTYPE=4.</p>

<b>VARIABLE</b>	<b>DESCRIPTION</b>
EFAC	Initial mesh remapping factor for PRTYPE=8 only, ranging between 0.0 and 1.0. When EFAC approaches 1.0, the remapping approaches pure Eulerian behavior. The smaller the value of EFAC, the closer the mesh will initially follow the material flow in the vicinity of a shock front, i.e. approaching Lagrangian behavior. Thus, a very small value might lead to severe mesh distortions because the mesh must deform severely to follow the material flow initially. Eventually over time, the mesh smoothing behavior will approach an Eulerian system.
FRCPAD	For PRTYPE=9: This is an ALE mesh padding fraction ranging from 0.01 to 0.2. If the characteristic Lagrange mesh dimension ( $dL_L$ ) exceeds $(1-2 * FRCPAD)$ times the characteristic ALE mesh dimension ( $dL_A$ ), then the ALE mesh is expanded so that $dL_A = dL_L / (1-2 * FRCPAD)$ . This provides extra few layers of ALE elements beyond the maximum Lagrangian range of motion. EQ.0.01: $dL_A = dL_L / 0.98 = dL_L * 1.020408$ EQ.0.20: $dL_A = dL_L / 0.60 = dL_L * 1.666667$
IEXPND	If PRTYPE=9: This is an ALE mesh expansion control flag. EQ.0: Both mesh expansion and contraction are allowed. EQ.1: Only mesh expansion is allowed.
IPIDXCL	An ALE set ID to be excluded from the expansion and/or contraction only. Translation and rotation are allowed. For example, this may be used to prevent the ALE mesh (or part) at the inflator gas inlet region from expanding too much. High ALE mesh resolution is usually required to resolve the high speed flow of the gas into the airbag via point sources (remark 2).
IPIDTYPE	Set ID type of IPIDXCL: 0 = PSID; 1 = PID

**Remarks:**

1. Some PRTYP may require a supplemental definition defined via corresponding PRID. For example, PRTYP=3 requires a \*ALE\_REFERENCE\_SYSTEM\_CURVE card. If PRID=n, then in the corresponding \*ALE\_REFERENCE\_SYSTEM\_CURVE card, ID=n. Similar association applies for any PRTYP (i.e. 3, 5, 6, or 7) which requires a definition for its corresponding PRID parameter.
2. For PRTYPE=9: ICR/NID can be useful to keep a high density ALE mesh centered on the region of greatest interest, (such as the inflator orifices region in an airbag model). For example, in the case of nonsymmetrical airbag deployment, assuming that the ALE mesh is initially finer near the inlet orifices, and gradually coarsened away from it. Defining an “anchor node” at the center of the orifice location will keep the fine ALE mesh region

centered on the orifice region. So that this fine ALE mesh region will not be shifted away (from the point sources) during expansion and translation. The ALE mesh can move and expand outward to envelop the Lagrangian airbag in such a way that the inlet is well resolved throughout the deployment.

- The table below shows the applicability of the various choices of PRTYPE. Simple deductions from the functional definitions of the PRTYPE choices will clarify the applications of the various constraints. For example, when PRTYP=3, nodal motion of the ALE mesh is completely controlled by the 12 curves. Therefore, no constraints are needed.

PRTYPE	ICR/NID	BCTRAN	BCROT	BCEXP
3	NO	NO	NO	NO
4	YES (ICR)	YES	YES	YES
5	NO	YES	NO	NO
6	NO	NO	NO	NO
7	NO	NO	NO	YES
8	NO	NO	NO	NO
9	YES (NID)	NO	NO	NO

**Example 1:**

Consider a bird-strike model containing 2 ALE parts: a bird is surrounded by air (or void). A part-set ID 1 is defined containing both parts. To allow for the meshes of these 2 parts to move with their combined mass-weighted-average velocity, PRTYPE=4 is used. Note that BCEXP=7 indicating mesh expansion is constrained in all global directions.

```

$...|...1...|...2...|...3...|...4...|...5...|...6...|...7...|...8
*ALE_REFERENCE_SYSTEM_GROUP
$   SID   STYPE   PRTYP   PRID   BCTRAN   BCEXP   BCROT   ICOORD
$     1     0     4     0     0     7     0
$   XC     YC     ZC   EXPLIM
$     0     0     0     0
$...|...1...|...2...|...3...|...4...|...5...|...6...|...7...|...8
    
```

**Example 2:**

Consider a bouncing ball model containing 2 ALE parts: a solid ball (PID 1) is surrounded by air or void (PID 2). A part-set ID 1 is defined containing both parts. To allow for the meshes of these 2 parts to move with 2 reference system types: (a) first, they move with their combined mass-weighted-average velocity between 0.0 and 0.01 second; and subsequently (between 0.01 and 10.0 seconds) their reference system is switched to (b) an Eulerian system (thus the mesh is

# \*ALE

# \*ALE\_REFERENCE\_SYSTEM\_GROUP

fixed in space), a reference system “SWITCH” is required. This is done by setting PRTYPE=6. This PRTYPE requires a corresponding \*ALE\_REFERENCE\_SYSTEM\_SWITCH card. Note that PRID=11 in the \*ALE\_REFERENCE\_SYSTEM\_GROUP card corresponds to the SWITCHID=11 in \*ALE\_REFERENCE\_SYSTEM\_SWITCH card.

```
$. . . | . . . 1 . . . | . . . 2 . . . | . . . 3 . . . | . . . 4 . . . | . . . 5 . . . | . . . 6 . . . | . . . 7 . . . | . . . 8
*ALE_REFERENCE_SYSTEM_GROUP
$      SID      STYPE      PRTYP      PRID      BCTRAN      BCEXP      BCROT      ICOORD
      1         0         6         11         0         7         7
$      XC         YC         ZC      EXPLIM      EULFACT      SMOOTHVMX
      0         0         0         0         0.0
*ALE_REFERENCE_SYSTEM_SWITCH
$ SWITCHID
      11
$      t1         t2         t3         t4         t5         t6         t7
      0.01        10.0
$      TYPE1      TYPE2      TYPE3      TYPE4      TYPE5      TYPE6      TYPE7      TYPE8
      4           0
$      ID1       ID2       ID3       ID4       ID5       ID6       ID7       ID8
      0         0         0         0         0         0         0         0
$. . . | . . . 1 . . . | . . . 2 . . . | . . . 3 . . . | . . . 4 . . . | . . . 5 . . . | . . . 6 . . . | . . . 7 . . . | . . . 8
```

**\*ALE\_REFERENCE\_SYSTEM\_NODE**

Purpose: This command defines a group of nodes that control the motion of an ALE mesh. It is used only when PRTYPE=5 or 7 in a corresponding \*ALE\_REFERENCE\_SYSTEM\_GROUP card.

Card 1            1            2            3            4            5            6            7            8

Variable	ID							
Type	I							
Default	none							

Card 2            1            2            3            4            5            6            7            8

Variable	NID1	NID2	NID3	NID4	NID5	NID6	NID7	NID8
Type	I	I	I	I	I	I	I	I
Default	none	none	none	none	none	none	none	none

Card 3            1            2            3            4            5            6            7            8

Variable	NID9	NID10	NID11	NID12				
Type	I	I	I	I				
Default	none	none	none	none				

<u>VARIABLE</u>	<u>DESCRIPTION</u>
ID	Node group ID for PRTYPE 5 or 7, see *ALE_REFERENCE_SYSTEM_GROUP.
NID1...NID12	User specified nodes.

**Remarks:**

- For PRTYPE=5 the ALE mesh is forced to follow the motion of a coordinate system, which is defined by three nodes (NID1, NID2, NID3). These nodes are located at  $x_1$ ,  $x_2$  and  $x_3$ , respectively. The axes of the coordinate system,  $x'$ ,  $y'$  and  $z'$ , are defined as:

$$\begin{aligned}
 x' &= (x_2 - x_1) / |x_2 - x_1| \\
 z' &= x' \times (x_3 - x_1) / |x' \times (x_3 - x_1)| \\
 y' &= z' \times x'
 \end{aligned}$$

Note that  $x_1 \rightarrow x_2$  is the local  $x'$  axis,  $x_1 \rightarrow x_3$  is the local  $y'$  axis and  $x'$  crosses  $y'$  gives the local  $z'$  axis. These 3 nodes are used to locate the reference system at any time. Therefore, their positions relative to each other should be as close to an orthogonal system as possible for better transformation accuracy of the ALE mesh.

- For PRTYPE=7, the ALE mesh is forced to move and expand, so as to enclose up to twelve user defined nodes (NID1...NID12). This is a rarely used option.

**Example 1:**

Consider modeling sloshing of water inside a rigid tank. Assuming there are 2 ALE parts, the water (PID 1) and air or void (PID 2) contained inside a rigid (Lagrangian) tank (PID 3). The outer boundary nodes of both ALE parts are merged with the inner tank nodes. A part-set ID 1 is defined containing both ALE parts (PIDs 1 and 2). To allow for the meshes of the 2 ALE parts to move with the rigid Lagrangian tank, PRTYPE=5 is used. The motion of the ALE parts then follows 3 reference nodes on the rigid tank. These 3 reference nodes must be defined by a corresponding \*ALE\_REFERENCE\_SYSTEM\_NODE card. In this case the reference nodes have the nodal IDs of 5, 6 and 7. Note that PRID=12 in the

\*ALE\_REFERENCE\_SYSTEM\_GROUP card corresponds to the SID=12 in the \*ALE\_REFERENCE\_SYSTEM\_NODE card.

```

$. . . | . . . 1 . . . | . . . 2 . . . | . . . 3 . . . | . . . 4 . . . | . . . 5 . . . | . . . 6 . . . | . . . 7 . . . | . . . 8
*ALE_REFERENCE_SYSTEM_GROUP
$      SID      STYPE      PRTYP      PRID      BCTRAN      BCEXP      BCROT      ICOORD
$      1         0         5         12
$      XC         YC         ZC      EXPLIM
$      0         0         0         0

```



\*ALE\_REFERENCE\_SYSTEM\_NODE

\$ NSID

12

\$ N1 N2 N3 N4 N5 N6 N7 N8

5

6

7

\$...|...1...|...2...|...3...|...4...|...5...|...6...|...7...|...8

**\*ALE\_REFERENCE\_SYSTEM\_SWITCH**

Purpose: The PRTYPE parameter in the \*ALE\_REFERENCE\_SYSTEM\_GROUP (ARSG) card allows many choices of the reference system types for any ALE geometric entity. This command allows for the time-dependent switches between these different types of reference systems, i.e., switching to multiple PRTYPEs at different times during the simulation. This command is required only when PRTYPE=6 in ARSG card. Please see example 2 in the ARSG section.

Card 1            1            2            3            4            5            6            7            8

Variable	ID							
Type	I							
Default	none							

Card 2            1            2            3            4            5            6            7            8

Variable	T1	T2	T3	T4	T5	T6	T7	
Type	F	F	F	F	F	F	F	
Default	0.0	0.0	0.0	0.0	0.0	0.0	0.0	

Card 3            1            2            3            4            5            6            7            8

Variable	TYPE1	TYPE2	TYPE3	TYPE4	TYPE5	TYPE6	TYPE7	TYPE8
Type	I	I	I	I	I	I	I	I
Default	0	0	0	0	0	0	0	0

Card 4            1            2            3            4            5            6            7            8

Variable	ID1	ID2	ID3	ID4	ID5	ID6	ID7	ID8
Type	I	I	I	I	I	I	I	I
Default	none	none	none	none	None	none	none	none

<u>VARIABLE</u>	<u>DESCRIPTION</u>
ID	Switch list ID, see *ALE_REFERENCE_SYSTEM_GROUP,
T1...T7	Times for switching reference system type. By default, the reference system TYPE1 occurs between time=0 and time=T1, and TYPE2 occurs between time=T1 and time=T2, etc.
TYPE1...TYPE8	Reference system types (also see PRTYPE under ARSG): EQ.0: Eulerian, EQ.1: Lagrangian, EQ.2: Normal ALE mesh smoothing, EQ.3: Prescribed motion following load curves, see *ALE_REFERENCE_SYSTEM_CURVE, EQ.4: Automatic mesh motion following mass weighted average velocity in ALE mesh, EQ.5: Automatic mesh motion following a local coordinate system defined by three user defined nodes, see *ALE_REFERENCE_SYSEM_NODE,
ID1...ID8	The corresponding PRID parameters supporting each PRTYPE used during the simulation.

**Remarks:**

1. The beginning time is assumed to be t=0, and the starting PRTYPE is TYPE1. So at T1, the 1<sup>st</sup> switching time, PRTYPE is switched from TYPE1 to TYPE2, and so forth. This option can be complex in nature so it is seldom applied.

**\*ALE\_REFINE**

Purpose: Refine ALE hexahedral solid elements locally. Each element called parent is replaced by 8 child elements with a volume equal to  $1/8^{\text{th}}$  the parent volume. If only the 1<sup>st</sup> card is defined, the refinement occurs during the initialization. The 2<sup>nd</sup> card defines a criterion CRITRF to automatically refine the elements during the run. If the 3<sup>rd</sup> card is defined, the refinement can be removed if a criterion CRITRM is reached: the child elements can be replaced by their parents.

Card 1            1            2            3            4            5            6            7            8

Variable	ID	TYPE	NLVL	MMSID				
Type	I	I	I	I				
Default	none	0	1	0				

**Optional Card 2 may be defined to refine automatically (each parent element can be replaced by a cluster of 8 child elements)**

Card 2            1            2            3            4            5            6            7            8

Variable	NTOTRF	NCYCRF	CRITRF	VALRF	BEGRF	ENDRF	LAYRF	
Type	I	I	I	F	F	F	I	
Default	0	0	0	0.0	0.0	0.0	0	

**Optional Card 3 may be defined to remove refinements (each cluster of 8 child elements can be replaced by their parent)**

Card 2            1            2            3            4            5            6            7            8

Variable	MAXRM	NCYCRM	CRITRM	VALRM	BEGRM	ENDRM		
Type	I	I	I	F	F	F		
Default	0	0	0	0.0	0.0	0.0		

---

<u>VARIABLE</u>	<u>DESCRIPTION</u>
ID	Set ID.
TYPE	Set type:: EQ.0: ALE Part Set, EQ.1: ALE Part, EQ.2: Lagrangian Part Set coupled to ALE (see Remarks 1 and 2), EQ.3: Lagrangian Part coupled to ALE (see Remarks 1 and 2), EQ.4: Shell Set coupled to ALE (see Remarks 1 and 2), EQ.5: Solid Set (see Remark 1).
NLVL	Number of refinement levels (see Remark 3).
MMSID	Multi-Material Set ID (see Remark 4): LT.0: only ALE elements with all the multi-material groups listed in *SET_MULTI-MATERIAL_GROUP_LIST can be refined (or removed otherwise) GT.0: ALE elements with at least one of the multi-material groups can be refined (or removed)
NTOTRF	Total number of ALE elements to refine (see Remark 5).
NCYCRF	Number of cycles between each refinement.
CRITRF	Refinement criterion: EQ.0: static refinement (as if only the 1 <sup>st</sup> card is defined), EQ.1: Pressure (if pressure > VALRF), EQ.2: Relative Volume (if V/Vo < VALRF) , EQ.3: Volume Fraction (if Volume fraction > VALRF).
VALRF	Criterion value to reach for the refinement.
BEGRF	Time to begin the refinement.
ENDRF	Time to end the refinement.
LAYRF	Number of element layers to refine around a element reaching the refinement criterion (see Remark 6).
MAXRM	Maximum number of child clusters to remove (see Remark 5): LT.0: for the whole run, GT.0: every NCYCRM cycles
NCYCRM	Number of cycles between each deletion

<b>VARIABLE</b>	<b>DESCRIPTION</b>
CRITRM	Deletion criterion: EQ.0: no deletion (as if only the 1 <sup>st</sup> and 2 <sup>nd</sup> card are defined), EQ.1: Pressure (if pressure < VALRM), EQ.2: Relative Volume (if V/V <sub>o</sub> > VALRM) , EQ.3: Volume Fraction (if Volume fraction < VALRM).
VALRM	Criterion value to reach in each child elements of a cluster for its deletion.
BEGRM	Time to begin the deletion.
ENDRM	Time to end the deletion.

**Remarks:**

1. If only the 1<sup>st</sup> card is defined, only parts and part sets can be defined.
2. \*CONSTRAINED\_LAGRANGE\_IN\_SOLID needs to be defined for TYPE=2,3,4. If an ALE element has at least one coupling point (see NQUAD in \*CONSTRAINED\_LAGRANGE\_IN\_SOLID), this element will be selected to be refined (or removed)
3. If NLVL=1, there is only one level of refinement: the ALE elements in \*ELEMENT\_SOLID are the only ones to be replaced by clusters of 8 child elements. If NLVL>1, there are several levels of refinement: not only the initial ALE elements in \*ELEMENT\_SOLID are refined but also their child elements. If NLVL=2 for example, the initial ALE elements are replaced by clusters of 64 child elements
4. If only the 1<sup>st</sup> card is defined, a multi-material set id is not used. It can be left to zero. For the 2<sup>nd</sup> and 3<sup>rd</sup> cards, MMSID is the ID of \*SET\_MULTI-MATERIAL\_GROUP\_LIST in which the multi-material group ids (as defined in \*ALE\_MULTI-MATERIAL\_GROUP) are listed to select the ALE elements to be refined (or removed). If MMSID<0, only mixed ALE elements containing all the multi-material groups can be refined. Otherwise clusters of 8 elements without a mix of the listed multi-material groups can be removed.
5. NTOTRF defines the total number of ALE elements to be refined. So for example NTOTRF=100 means that only 100 ALE elements will be replaced by 800 ALE finer elements (or 100 clusters of 8 child elements). If negative, MAXRM is the exact opposite of NTOTRF and it defines a total number of child clusters to remove for the whole run. If positive, MAXRM defines an upper limit for the number of child clusters to remove every NCYCRM cycles.
6. If an element is refined, it is possible to refine the neighbor elements as well. LAYRF defines the number of neighbor layers to refine. For example, LAYRF=2 for an element at the center of a block of 5x5x5 elements will refine these 75 elements.

**\*ALE\_SMOOTHING**

Purpose: This smoothing constraint keeps a node at its initial parametric location along a line between two other nodes. This constraint is active during each mesh smoothing operation.

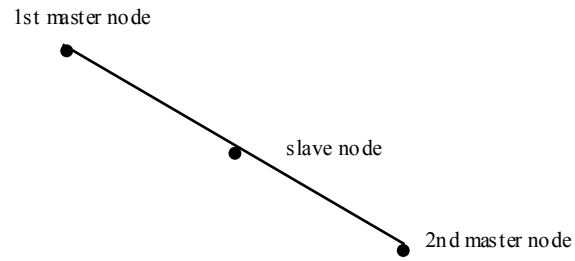
Card 1            1            2            3            4            5            6            7            8

Variable	SNID	MNID1	MNID2	IPRE	XCO	YCO	ZCO	
Type	I	I	I	I	F	F	F	
Default	none	none	none	0	0.0	0.0	0.0	

<u>VARIABLE</u>	<u>DESCRIPTION</u>
SNID	Slave node ID, see Figure 4.1.
MNID1	First master node ID.
MNID2	Second master node ID.
IPRE	EQ.0: smoothing constraints are performed after mesh relaxation, EQ.1: smoothing constraints are performed before mesh relaxation.
XCO	x-coordinate of constraint vector
YCO	y-coordinate of constraint vector
ZCO	z-coordinate of constraint vector

**Remarks:**

1. Arbitrary Lagrangian Eulerian meshes are defined via the choice of the element type and the \*CONTROL\_ALE card. This can only be used with solid elements.



**Figure 4.1** This simple constraint, which ensures that a slave node remains on a straight line between two master nodes, is sometimes necessary during ALE smoothing.



**\*ALE\_TANK\_TEST**

Purpose: This command allows for the airbag information input ( $\dot{m}(t), \bar{T}_{gas}(t)$ ) of the control volume (\*AIRBAG\_) approach to be used as input for the ALE/Eulerian fluid-structure interaction model of the airbag. It complements and must be used together with the \*SECTION\_POINT\_SOURCE command. Please see \*SECTION\_POINT\_SOURCE for additional information.

Card 1            1            2            3            4            5            6            7            8

Variable	MDOTLC	TANKV	PAMB	PFINAL	MACHL	VELMAX	AORIF	
Type	I	I	I	I	F	F	F	
Default	0	0.0	0.0	0.0	0.0	0.0	0.0	

Card 2            1            2            3            4            5            6            7            8

Variable	AMGIDG	AMGIDA	NUMPNT					
Type	I	I	I					
Default	0	0	50					

**VARIABLE****DESCRIPTION**

MDOTLC	LCID for mass flow rate as a function of time. This may be obtained directly from the control-volume type input data.
TANKV	Volume of the tank used in a tank test from which the tank pressure is measured, and $\dot{m}(t)$ and $\bar{T}_{gas}(t)$ are computed from this tank pressure data.
PAMB	The pressure inside the tank before jetting (usually 1bar).
PFINAL	The final equilibrated pressure inside the tank from the tank test.
MACHL	A limiting MACH number for the gas at the throat (MACH=1 preferred).

<b>VARIABLE</b>	<b>DESCRIPTION</b>
VELMAX	Maximum allowable gas velocity across the inflator orifice (not preferred).
AORIF	Total inflator orifice area (optional, only needed if the *SECTION_POINT_SOURCE card is not used).
AMGIDG	The ALE multi-material group ID (AMMGID) of the gas.
AMGIDA	The ALE multi-material group ID (AMMGID) of the air.
NUMPNT	The number of points in $\dot{m}(t)$ and $\bar{T}_{gas}(t)$ curves. If NUMPNT=0, defaults to 50 points.

**Remarks:**

1. In an airbag inflator tank test, the tank pressure data is measured. This pressure is used to derive  $\dot{m}(t)$  and the estimated  $\bar{T}_{gas}(t)$ , usually via a lumped-parameter method, a system of conservation equations and EOS. These 2 curves are used as the direct input for the control volume method in LS-DYNA via the \*AIRBAG\_ cards. Typically,  $\bar{T}_{gas}(t)$  is the stagnation temperature of the incoming inflator gas. In an ALE or Eulerian fluid-structure interaction analysis, the gas velocity,  $vel(t)$ , and density,  $\rho(t)$ , at the inlet must be computed. Since only  $\dot{m}(t)$  is known, additional assumptions about the inlet condition must be made to compute both  $vel(t)$  and  $\rho(t)$  curves from the information available. If this computation is done outside of LS-DYNA, then  $\dot{m}(t)$  and  $\bar{T}_{gas}(t)$  are used to compute 3 curves which are then used as the input for the ALE model:  $\bar{T}_{gas\_corrected}(t)$ ,  $vel(t)$  and  $\rho(t)$ . This \*ALE\_TANK\_TEST card allows for this inlet condition conversion to be done inside LS-DYNA. Thus, with this card together with the \*SECTION\_POINT\_SOURCE card, LS-DYNA can take in directly the control volume input ( $\dot{m}(t)$  and  $\bar{T}_{gas}(t)$ ) and performs an ALE or Eulerian fluid-structure interaction analysis. The users do not have to do the conversion themselves.

If the \*ALE\_TANK\_TEST card is present:

2. The definitions of the relative volume,  $v_r(t)$  and  $vel(t)$  curves in the \*SECTION\_POINT\_SOURCE card will be ignored. They are computed internally inside LS-DYNA.
3. The  $\dot{m}(t)$  curve will be read in on \*ALE\_TANK\_TEST card.
4. The  $\bar{T}_{gas}(t)$  curve (stagnation temperature) will be read in on \*SECTION\_POINT\_SOURCE card (not  $\bar{T}_{gas\_corrected}(t)$ ). A fine distinction between the two temperatures may

be made.  $\bar{T}_{gas}(t)$  is derived directly from the tank pressure data based on a lump-parameter approach.  $\bar{T}_{gas\_corrected}(t)$  is computed from  $\dot{m}(t)$  and  $\bar{T}_{gas}(t)$  with additional isentropic and sonic flow assumption for the maximum velocity at an orifice ( $\bar{T}_{gas\_corrected}(t)$  is the static temperature). These assumptions are necessary since in  $\dot{m}(t) = \rho(t) * vel(t) * A$ , we only know  $\dot{m}(t)$  (1 known) but we need  $\rho(t)$  and  $vel(t)$  (2 unknowns).

5. The inflator area is computed from the \*SECTION\_POINT\_SOURCE card that has the AMMGID of the inflator gas in the \*ALE\_TANK\_TEST card. If the \*BOUNDARY\_ AMBIENT\_EOS card is used instead of the \*SECTION\_POINT\_SOURCE card, then the area may be input in this \*ALE\_TANK\_TEST card.
6. The reference density of the propellant “gas”,  $\rho_0$ , is computed internally and automatically used for the calculation. The  $\rho_0$  value from the \*MAT\_NULL card is ignored.

### Example:

Consider a tank test model consists of the inflator gas (PID 1) and the air inside the tank (PID 2). The following information from the control volume model is available:

- $\dot{m}(t)$  (LCID 1 is from control volume model input).
- $\bar{T}_{gas}(t)$  (LCID 2 is from control volume model input).
- Volume of the tank used in the inflator tank test.
- Final equilibrated pressure inside the tank.
- Ambient pressure in the air.

Also available are:

- The nodal IDs of the nodes defining the orifice holes through which the gas flows into the tank.
- The area associated with each hole (the node is assumed to be at the center of this area).
- The vector associated with each hole defining the direction of flow.

In the input below LCID 1 and 2 are  $\dot{m}(t)$  and  $\bar{T}_{gas}(t)$ , respectively. LCID 4 and 5 will be ignored when the \*ALE\_TANK\_TEST card is present. If it is not present, all 3 curves in the \*SECTION\_POINT\_SOURCE card will be used. When the \*SECTION\_POINT\_SOURCE card is present, the element formulation is equivalent to an ELFORM=11.

```

$. . . | . . . 1 . . . | . . . 2 . . . | . . . 3 . . . | . . . 4 . . . | . . . 5 . . . | . . . 6 . . . | . . . 7 . . . | . . . 8
*PART
inflator gas
$      PID      SECID      MID      EOSID      HGID      GRAV      ADPOPT      TMID
      1         1         1         0         0         0         0         0
*PART
air inside the tank
$      PID      SECID      MID      EOSID      HGID      GRAV      ADPOPT      TMID
      2         2         2         0         0         0         0         0

```

```
*SECTION_SOLID
$   SECID   ELFORM   AET
    2       11       0
*ALE_MULTI-MATERIAL_GROUP
$   SID     SIDTYPE
    1       1
    2       1
*SECTION_POINT_SOURCE
$   SECID   LCIDT   LCIDVOLR   LCIDVEL   <= 3 curves in tempvolrvel.k file
    1       2       4       5
$   NODEID  VECTID   AREA
    24485   3       15.066
    ...
    24557   3       15.066
*ALE_TANK_TEST
$   MDOTLC   TANKV    PAMB     PFINAL    MACHL    VELMAX    AORIF
    1       6.0E7    1.0E-4   5.288E-4  1.0      0.0
$   AMGIDG   AMGIDA    NUPNT
    1       2       80
$. . . | . . . 1 . . . | . . . 2 . . . | . . . 3 . . . | . . . 4 . . . | . . . 5 . . . | . . . 6 . . . | . . . 7 . . . | . . . 8
```

**\*ALE\_UP\_SWITCH**

Purpose: For the simulation of airbag inflation process, this card allows the switching from an ALE computation to a control volume (CV) or uniform pressure (UP) method at a user-defined switch time.

Card 1            1            2            3            4            5            6            7            8

Variable	UPID	SWTIME						
Type	I	F						
Default	0	1.0e+16						
Remarks	1							

Card 2            1            2            3            4            5            6            7            8

Variable	FSI_ID1	FSI_ID2	FSI_ID3	FSI_ID4	FSI_ID5	FSI_ID6	FSI_ID7	FSI_ID8
Type	I	I	I	I	I	I	I	I
Default	0	0	0	0	0	0	0	0
Remarks								

**Optional Card 3 Format – input only if UPID=0 or not defined.**

Card 3            1            2            3            4            5            6            7            8

Variable	SID	SIDTYPE	MMGAIR	MMGGAS				
Type	I	I	I	I				
Default	0	0	0	0				
Remarks								

<u>VARIABLE</u>	<u>DESCRIPTION</u>
UPID	<p>An ID defines a corresponding *AIRBAG_HYBRID_ID card for use in an ALE-method-switching-to-CV-method simulation. The simulation starts with ALE computational method, then switches to a CV (or UP) method at some given time.</p> <p>EQ.0: (or blank) The code will construct an equivalent *AIRBAG_HYBRID_ID card automatically internally, (default). The 3<sup>rd</sup> optional line is then a required input.</p> <p>NE.0: An ID points to a corresponding *AIRBAG_HYBRID_ID card which must be defined for use after the switch. If UPID is defined, do not define the 3<sup>rd</sup> optional card.</p>
SWTIME	<p>The time at which the computation does a switch from an ALE-method-to-CV-method.</p>
FSI_ID1 ... ID8	<p>Coupling IDs for one or more ALE fluid-structure-interaction (FSI) *CONSTRAINED_LAGRANGE_IN_SOLID_ID cards. These couplings are deleted during the 2<sup>nd</sup>, CV computational phase.</p>
SID	<p>A set ID defines the Lagrangian parts which make up the airbag.</p>
SIDTYPE	<p>Set ID type for the above SETID (following the conventions in *AIRBAG_HYBRID card).</p> <p>EQ.0: SID is a segment set ID (SGSID).</p> <p>NE.0: SID is a part set ID (PSID).</p>
MMGAIR	<p>The AMMG (ALE multi-material group) ID of surrounding air.</p>
MMGGAS	<p>The AMMG ID of inflator gas injected into the airbag.</p>

**Remarks:**

1. If UPID is zero or blank, optional card 3 must be defined. LSDYNA will construct an equivalent \*AIRBAG\_HYBRID\_ID card automatically.

**Example 1:**

Consider an airbag model with a 2-phase simulation: an ALE calculation being switched to a CV method. During the CV phase, the simulation is defined by an \*AIRBAG\_HYBRID\_ID card.

```

$. . . | . . . 1 . . . | . . . 2 . . . | . . . 3 . . . | . . . 4 . . . | . . . 5 . . . | . . . 6 . . . | . . . 7 . . . | . . . 8
*ALE_UP_SWITCH
$  UP_ID  SW_time
 100000  2.0000
$ FSI_ID_1 FSI_ID_2 FSI_ID_3 FSI_ID_4 FSI_ID_5 FSI_ID_6 FSI_ID_7 FSI_ID_8
   1         2
$-----
*AIRBAG_HYBRID_ID
$  ID
 100000
$  SID  SIDTYP  RBID  VSCA  PSCA  VINI  MWD  SPSF
   2         1         0     1.0   1.0   0.0   0.0   0.0
$ 2  ATMT  ATMP  ATMD  GC  CC
 293. 1.0130e-4 1.200E-9 8.3143 1.
$  C23  LCC23  A23  LCA23  CP23  LCP23  AP23  LCAP23
$  OPT  PVENT  NGAS
         4
$bac LCIDM  LCIDT  NOTUSED  MW  INITM  A  B  C
 1001  1002         0.0288691  1.0  28.98
$  FMASS
$air LCIDM  LCIDT  NOTUSED  MW  INITM  A  B  C
 1600  1603         28.97E-3  0.0  26.38  8.178e-3 -1.612e-6
$  FMASS
$pyroLCIDM  LCIDT  NOTUSED  MW  INITM  A  B  C
 1601  1603         43.45E-3  0.0  32.87  2.127e-2 -5.193E-6
$  FMASS
$sto_LCIDM  LCIDT  NOTUSED  MW  INITM  A  B  C
 1602  1603         39.49E-3  0.0  22.41  2.865e-3 -6.995e-7
$  FMASS
$. . . | . . . 1 . . . | . . . 2 . . . | . . . 3 . . . | . . . 4 . . . | . . . 5 . . . | . . . 6 . . . | . . . 7 . . . | . . . 8

```

**Example 2:**

Consider the same airbag model with the same 2-phase simulation. However, all the \*AIRBAG\_HYBRID\_ID card definitions are extracted automatically from the ALE model. There is no need to define the \*AIRBAG\_HYBRID\_ID card. The 3<sup>rd</sup> optional card is required.

```
$...|...1...|...2...|...3...|...4...|...5...|...6...|...7...|...8
*ALE_UP_SWITCH
$  UP_ID  SW_time
$ 100000  2.0000
    0    2.0000
$ FSI_ID_1 FSI_ID_2 FSI_ID_3 FSI_ID_4 FSI_ID_5 FSI_ID_6 FSI_ID_7 FSI_ID_8
    1        2
$  SETID  SETYPE  MMG_AIR  MMG_GAS
    2      1      2      1
$...|...1...|...2...|...3...|...4...|...5...|...6...|...7...|...8
```



# **\*BOUNDARY**

The keyword **\*BOUNDARY** provides a way of defining imposed motions on boundary nodes. The keyword control cards in this section are defined in alphabetical order:

**\*BOUNDARY\_ACOUSTIC\_COUPLING**  
**\*BOUNDARY\_ALE\_MAPPING**  
**\*BOUNDARY\_AMBIENT\_EOS**  
**\*BOUNDARY\_CONVECTION\_OPTION**  
**\*BOUNDARY\_CYCLIC**  
**\*BOUNDARY\_ELEMENT\_METHOD\_ACOUSTIC**  
**\*BOUNDARY\_ELEMENT\_METHOD\_OPTION**  
**\*BOUNDARY\_FLUX\_OPTION**  
**\*BOUNDARY\_MCOL**  
**\*BOUNDARY\_NON\_REFLECTING**  
**\*BOUNDARY\_NON\_REFLECTING\_2D**  
**\*BOUNDARY\_PAP**  
**\*BOUNDARY\_PORE\_FLUID\_OPTION**  
**\*BOUNDARY\_PRESCRIBED\_ACCELEROMETER\_RIGID**  
**\*BOUNDARY\_PRESCRIBED\_FINAL\_GEOMETRY**  
**\*BOUNDARY\_PRESCRIBED\_MOTION\_{OPTION1}\_{OPTION2}**  
**\*BOUNDARY\_PRESCRIBED\_ORIENTATION\_RIGID\_OPTION**  
**\*BOUNDARY\_PRESSURE\_OUTFLOW\_OPTION**  
**\*BOUNDARY\_PWP\_OPTION**  
**\*BOUNDARY\_RADIATION\_OPTION**  
**\*BOUNDARY\_SLIDING\_PLANE**  
**\*BOUNDARY\_SPC\_{OPTION1}\_{OPTION2}\_{OPTION3}**  
**\*BOUNDARY\_SPH\_FLOW**  
**\*BOUNDARY\_SPH\_SYMMETRY\_PLANE**  
**\*BOUNDARY\_SYMMETRY\_FAILURE**

# **\*BOUNDARY**

---

**\*BOUNDARY\_TEMPERATURE\_OPTION**

**\*BOUNDARY\_THERMAL\_WELD**

**\*BOUNDARY\_USA\_SURFACE**

**\*BOUNDARY\_ACOUSTIC\_COUPLING**

Purpose: Define a segment set for acoustic coupling. The segments should define the surface of a shell or solid (structural) element. This option allows for acoustic elements (type 8 solid elements) to couple on either one side of a shell or solid element structure or both sides of a shell structure. The nodal points of the shell segments and those on either side of the segments must be coincident. If the fluid exists on just one side of the segment and if the nodes are merged, no input is necessary and input data in this section is not needed. Two-sided coupling will not work if the interface nodes are merged out.

Card            1            2            3            4            5            6            7            8

Variable	SSID							
Type	I							
Default	none							

<u>VARIABLE</u>	<u>DESCRIPTION</u>
SSID	Segment set ID, see *SET_SEGMENT

**Remarks:**

For the stability of the acoustic-structure coupling, the following condition must be satisfied:

$$\frac{2\rho_a D}{\rho_s t_s} < 5$$

where  $\rho_a$  is the density of the acoustic medium,  $D$  is the total thickness of the acoustic elements adjacent to the structural element,  $\rho_s$  is the density, and  $t_s$  is the thickness of the structural shell element.

# \*BOUNDARY

# \*BOUNDARY\_ALE\_MAPPING

## \*BOUNDARY\_ALE\_MAPPING

Purpose: This card maps ALE data histories from a previous run to a region of elements. Data are read or written in a mapping file called by the prompt "map=" on the command line (see remark 4 and 5). To map data at the initial time (not the histories) to all the ALE domain (not just a region of elements) see \*INITIAL\_ALE\_MAPPING.

Card 1            1            2            3            4            5            6            7            8

Variable	ID	TYP	AMMSID	IVOLTYP	BIRTH	DEATH	DTOUT	INI
Type	I	I	I	I	F	F	F	I
Default	none	none	none	none	0.0	1e20	time step	0

Card 2            1            2            3            4            5            6            7            8

Variable	THICK	RADIUS	X1	Y1	Z1	X2	Y2	Z2
Type	F	F	F	F	F	F	F	F
Default	0.0	0.0	0.0	0.0	0.0	0.0	0.0	0.0

Card 3            1            2            3            4            5            6            7            8

Variable	XO	YO	ZO	VECID				
Type	F	F	F	I				
Default	0.0	0.0	0.0	None				

### VARIABLE

### DESCRIPTION

ID

Part ID or part set ID or element set ID

<b>VARIABLE</b>	<b>DESCRIPTION</b>
TYP	Type of "ID" (see remark 1): EQ.0: part set ID. EQ.1: part ID. EQ.2: shell set ID. EQ.3: solid set ID.
AMMSID	Set ID of ALE multi-material groups defined in *SET_MULTI-MATERIAL_GROUP. See remark 1.
IVOLTYTYP	Type of volume containing the selected elements for the mapping: EQ.1: Spherical surface with thickness (THICK). EQ.2: Box. EQ.3: Cylindrical surface with thickness (THICK) EQ.4: All the elements defined by ID. If ivoltyp<0, data from the mapping file are read for the elements of this volume. If ivoltyp>0, data from the elements of this volume are written in the mapping file.
BIRTH	Birth time to write or read the mapping file. If a mapping file is written, the next run reading this file will begin at time BIRTH if this parameter for this next run is not larger.
DEATH	Death time to write or read the mapping file. If a mapping file is written, the next run will stop to read this file at time DEATH if this parameter for this next run is not smaller.
DTOUT	Time interval between outputs in the mapping file. This parameter is only used to write in the mapping file.
INI	Flag to initialize all the ALE domain of the next run: EQ.0: No initialization EQ.1: Initialization. *INITIAL_ALE_MAPPING will have to be in the input deck of the next run to read the data from the mapping file. The initial time of the next run will be BIRTH.
THICK	Thickness for the element selection using surfaces.
RADIUS	Radius for abs(ivoltyp)=1 and abs(ivoltyp)=2.

---

<b>VARIABLE</b>	<b>DESCRIPTION</b>
X1	Geometric parameter defined by ivoltyp: If abs(ivoltyp)=1, X1 is the X-coordinate of the sphere center. If abs(ivoltyp)=2, X1 is the X-coordinate of the minimum coordinate of the box. If abs(ivoltyp)=3, X1 is the X-coordinate of a point on the cylinder axis. If abs(ivoltyp)=4, X1 is ignored.
Y1	Geometric parameter defined by ivoltyp: If abs(ivoltyp)=1, Y1 is the Y-coordinate of the sphere center. If abs(ivoltyp)=2, Y1 is the Y-coordinate of the minimum coordinate of the box. If abs(ivoltyp)=3, Y1 is the Y-coordinate of a point on the cylinder axis. If abs(ivoltyp)=4, Y1 is ignored.
Z1	Geometric parameter defined by ivoltyp: If abs(ivoltyp)=1, Z1 is the Z-coordinate of the sphere center. If abs(ivoltyp)=2, Z1 is the Z-coordinate of the minimum coordinate of the box. If abs(ivoltyp)=3, Z1 is the Z-coordinate of a point on the cylinder axis. If abs(ivoltyp)=4, Z1 is ignored.
X2	Geometric parameter defined by ivoltyp: If abs(ivoltyp)=1, X2 is ignored If abs(ivoltyp)=2, X2 is the X-coordinate of the maximum coordinate of the box. If abs(ivoltyp)=3, X2 is the X-coordinate of a vector parallel to the cylinder axis. If abs(ivoltyp)=4, X2 is ignored.
Y2	Geometric parameter defined by ivoltyp: If abs(ivoltyp)=1, Y2 is ignored If abs(ivoltyp)=2, Y2 is the Y-coordinate of the maximum coordinate of the box. If abs(ivoltyp)=3, Y2 is the Y-coordinate of a vector parallel to the cylinder axis. If abs(ivoltyp)=4, Y2 is ignored.

<b>VARIABLE</b>	<b>DESCRIPTION</b>
Z2	Geometric parameter defined by ivoltyp: If abs(ivoltyp)=1, Z2 is ignored If abs(ivoltyp)=2, Z2 is the Z-coordinate of the maximum coordinate of the box. If abs(ivoltyp)=3, Z2 is the Z-coordinate of a vector parallel to the cylinder axis. If abs(ivoltyp)=4, X2 is ignored.
XO	Origin position in global X-direction. See remark 2.
YO	Origin position in global Y-direction. See remark 2.
ZO	Origin position in global Z-direction. See remark 2.
VECID	ID of the symmetric axis defined by *DEFINE_VECTOR. See remark 3.

**Remarks:**

- The routines of this card need to know which mesh will be initialized with the mapping data and more specifically which multi-material groups. The first 2 parameters (ID and TYP) defines the mesh and the third one (AMMSID) calls the \*SET\_MULTI-MATERIAL\_GROUP\_LIST card. This card will define a list of material groups in the current run. The rank in this list should match the rank of the multi-material groups from the previous run (as a reminder the ranks of multi-material groups are defined by \*ALE\_MULTI-MATERIAL\_GROUP). Let's take an example. For instance if the previous model has 3 groups, the current one has 5 groups and the following mapping is wanted:

- The 1<sup>st</sup> group from the previous run is mapped on the 3<sup>rd</sup> one in the current run,
  - The 2<sup>nd</sup> group from the previous run is mapped on the 5<sup>th</sup> one in the current run,
  - The 3<sup>rd</sup> group from the previous run is mapped on the 4<sup>th</sup> one in the current run,
- The \*SET\_MULTI-MATERIAL\_GROUP\_LIST card should be set as follows:

```
*SET_MULTI-MATERIAL_GROUP_LIST
300
3,5,4
```

- The data can be mapped in different parts of the mesh by defining the origin of the coordinate system (XO,YO,ZO).
- For a mapping between a 2D axisymmetric model and a 3D run the symmetric axis orientation in the 3D model needs to be defined.

4. To make one mapping: only the prompt “map=” is necessary. If IVOLTYP is positive, the mapping file will be created and ALE data histories will be written in this file. If IVOLTYP is negative the mapping file will be read and ALE data histories will be used to interpolate the ALE variables of the selected elements.
5. To make several successive mapping: the prompt “map1=” is necessary. If IVOLTYP is positive and the prompt “map1=” is in the command line, the ALE data are written to the mapping file given by “map1=”. If IVOLTYP is negative and the prompt “map=” is in the command line, ALE data are read from the mapping file given by “map=”.



**\*BOUNDARY\_AMBIENT\_EOS**

Purpose: This command defines the IDs of 2 load curves: (1) internal energy per unit reference volume (or temperature if using \*EOS\_IDEAL\_GAS) and (2) relative volume. These 2 curves completely prescribe the thermodynamic state as a function of time for any ALE or Eulerian part with an “ambient” type element formulation (please see Remark 4).

Card                    1                    2                    3                    4                    5                    6                    7                    8

Variable	PID	LCID1	LCID2						
Type	I	I	I						
Default	none	none	none						

**VARIABLE****DESCRIPTION**

PID	The ambient Part ID for which the thermodynamic state is being defined.
LCID1	A load curve ID for internal energy per unit reference volume (please read the beginning of the EOS section for details). If *EOS_IDEAL_GAS is being used, this ID then refers to a temperature load curve ID.
LCID2	Load curve ID for relative volume, $v_r = \left(\frac{v}{v_0} = \frac{\rho_0}{\rho}\right)$ . (Please read the beginning of the EOS section for details).

**Remarks:**

1. The term “ambient” refers to a medium that has predetermined thermodynamic state throughout the simulation. All “ambient” parts/elements will have its thermodynamic state reset back to this predetermined state every cycle. If this state is defined via the \*EOS\_ card, then this predetermined thermodynamic state is constant throughout the simulation. If it is defined via this card, \*BOUNDARY\_AMBIENT\_EOS, then its thermodynamic state will vary according to these defined load curves. “Ambient” part is sometimes also referred to as “reservoir” part as it may be used to simulate semi-infinite region.

2. In general, a thermodynamic state of a non-reacting and no-phase-change material may be defined by 2 thermodynamic variables. By defining (a) an internal energy per unit reference volume load curve (or a temperature load curve if using \*EOS\_IDEAL\_GAS) and (b) a relative volume load curve, the pressure as a function of time for this ambient part ID can be computed directly via the equation of state (\*EOS\_).
3. A reference specific volume,  $v_0 = \frac{1}{\rho_0}$ , is the inverse of a reference density,  $\rho_0$ . The reference density is defined as the density at which the material is under a reference or nominal state. Please refer to the \*EOS section for additional explanation on this.
4. The internal energy per unit reference volume may be defined as  $e_{ipv0} = \frac{c_v T}{v_0}$ . The specific internal energy (or internal energy per unit mass) is defined as  $C_v T$ .
5. This card is only to be used with “ambient” element type as defined by the parameters under the \*SECTION\_SOLID card:
  - ELFORM = 7, or
  - ELFORM = 11 and AET=4, or
  - ELFORM = 12 and AET=4.

**Example:**

Consider an ambient ALE part ID 1 which has its internal energy per unit reference volume in a load curve ID 2 and relative volume load curve ID 3:

```

$...|...1...|...2...|...3...|...4...|...5...|...6...|...7...|...8
*BOUNDARY_AMBIENT_EOS
$      PID  e/T_LCID  rvol_LCID
      1      2      3
$...|...1...|...2...|...3...|...4...|...5...|...6...|...7...|...8

```

**\*BOUNDARY\_CONVECTION\_OPTION**

Available options include:

**SEGMENT**

**SET**

Purpose: Define convection boundary conditions for a thermal or coupled thermal/structural analysis. Two cards are defined for each option.

For the **SET** option define the following card:

Card 1            1            2            3            4            5            6            7            8

Variable	SSID								
Type	I								
Default	none								

**For the SEGMENT option define the following card:**

Card 1            1            2            3            4            5            6            7            8

Variable	N1	N2	N3	N4					
Type	I	I	I	I					
Default	none	none	none	none					

Define the following card for both options:

Card 2            1            2            3            4            5            6            7            8

Variable	HLCID	HMULT	TLCID	TMULT	LOC			
Type	I	F	I	F	I			
Default	none	0.	none	0.	0			

**VARIABLE****DESCRIPTION**

SSID	Segment set ID, see *SET_SEGMENT.
N1,N2...	Node ID's defining segment.
HLCID	Load curve ID for heat transfer coefficient, h: GT.0: function versus time, EQ.0: use constant multiplier value, HMULT, LT.0: function versus temperature.
HMULT	Curve multiplier for h.
TLCID	Load curve ID for $T_\infty$ versus time, see *DEFINE_CURVE: EQ.0: use constant multiplier value, TMULT.
TMULT	Curve multiplier for $T_\infty$
LOC	Application of surface for thermal shell elements, see parameter, THSHEL, in the *CONTROL_SHELL input: EQ.-1: lower surface of thermal shell element EQ. 1: upper surface of thermal shell element

**Remarks:**

A convection boundary condition is calculated using  $q'' = h(T - T_\infty)$  where

h            heat transfer coefficient

$(T - T_\infty)$             temperature potential

Three alternatives are possible for the heat transfer coefficient which can be a function of time, a function of temperature, or constant. Also, the temperature of the boundary  $T_\infty$  can be either constant or a function of time. For both curves, multipliers can be used to scale the values.



**Remarks:**

This option is only available in the MPP version, and allows for loose coupling with other MPI programs using a “multiple program” execution method. Currently it is only useful when linking with MPP-DYNA for the modeling of multiscale spotwelds (type=2, prog=1). See \*INCLUDE\_MULTISCALE\_SPOTWELD for information about using this capability.

**\*BOUNDARY\_CYCLIC\_{OPTION}**

OPTION allows an optional ID to be given that applies each cyclic definition

**ID**

Purpose: Define nodes in boundary planes for cyclic symmetry.

These boundary conditions can be used to model a segment of an object that has rotational symmetry such as an impeller, i.e., Figure 5.1. The segment boundary, denoted as a side 1 and side 2, may be curved or planar. In this section, a paired list of points are defined on the sides that are to be joined.

**The following card is read if and only if the ID option is specified.**

Optional 2

Variable	ID	HEADING
Type	I	A70

Card 1 2 3 4 5 6 7 8

Variable	XC	YC	ZC	NSID1	NSID2	IGLOBAL	ISORT	
Type	F	F	F	I	I	I	I	
Default	none	none	none	none	none	0	0	

<u>VARIABLE</u>	<u>DESCRIPTION</u>
XC	x-component axis vector of axis of rotation
YC	y-component axis vector of axis of rotation
ZC	z-component axis vector of axis of rotation
NSID1	Node set ID for first boundary (side 1, see Figure 5.1).
NSID2	Node set ID for second boundary (side 2, see Figure 5.1). Each node in this set is constrained to its corresponding node in the first node set.

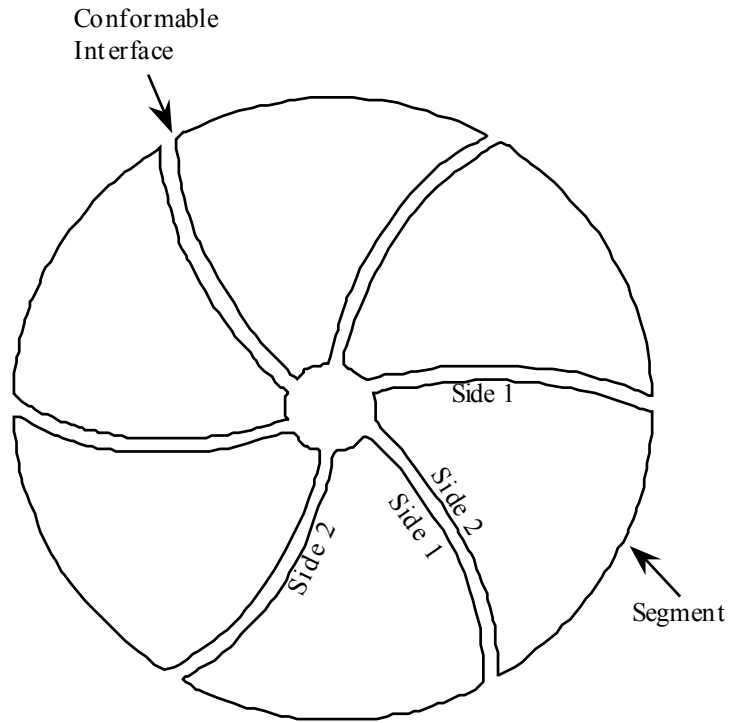
---

<u>VARIABLE</u>	<u>DESCRIPTION</u>
	Node sets NSID1 and NSID2 must contain the same number of nodal points. The shape of the two surfaces formed by the two node sets need not be planar but the shapes should match.
IGLOBAL	Flag for repeating symmetry: EQ.0: Axi-symmetric cyclic symmetry (default) EQ.1: Repeating symmetry in planes normal to global X EQ.2: Repeating symmetry in planes normal to global Y EQ.3: Repeating symmetry in planes normal to global Z
ISORT	Set to 1 for automatic sorting of nodes in node sets. See Remark 2.

**Remarks:**

1. Each node set should generally be boundaries of the model.
2. Prior to version 970, it was assumed that the nodes are correctly ordered within each set, i.e. the  $n^{\text{th}}$  node in NSID1 is equivalent to the  $n^{\text{th}}$  node in NSID2. In version 970 and later versions, if the ISORT flag is active, the nodes in NSID2 are automatically sorted to achieve equivalence, so the nodes can be picked by the quickest available method. However, for axi-symmetric cyclic symmetry (IGLOBAL=0), it is assumed that the axis passes through the origin, i.e., only globally defined axes of rotation are possible.





**Figure 5.1** With axi-symmetric cyclic symmetry only one segment is modeled.

**\*BOUNDARY\_FLUX\_OPTION**

Available options include:

**SEGMENT****SET**

Purpose: Define flux boundary conditions for a thermal or coupled thermal/structural analysis. Two or more cards are defined for each option. History variables can be associated with the boundary condition which will invoke a call to a user defined boundary flux subroutine for computing the flux.

For the **SET** option define the following card:

Card 1            1            2            3            4            5            6            7            8

Variable	SSID								
Type	I								
Default	none								

**For the SEGMENT option define the following card:**

Card 1            1            2            3            4            5            6            7            8

Variable	N1	N2	N3	N4					
Type	I	I	I	I					
Default	none	none	none	none					

Define the following card for both options:

Card 2            1            2            3            4            5            6            7            8

Variable	LCID	MLC1	MLC2	MLC3	MLC4	LOC	NHISV	
Type	I	F	F	F	F	I	I	
Default	none	0.	0.	0.	0.	0	0	

Define as many cards as necessary to initialize NHISV history variables.

Card 3            1            2            3            4            5            6            7            8

Variable	HISV1	HISV2	HISV3	HISV4	HISV5	HISV6	HISV7	HISV8
Type	F	F	F	F	F	F	F	F
Default	0.	0.	0.	0.	0.	0.	0.	0.

**VARIABLE****DESCRIPTION**

SSID	Segment set ID, see *SET_SEGMENT
N1,N2...	Node ID's defining segment
LCID	Load curve ID for heat flux, see *DEFINE_CURVE: GT.0: function versus time, EQ.0: use constant multiplier values at nodes, LT.0: function versus temperature.
MLC1	Curve multiplier at node N <sub>1</sub> , see Figure 5.2.
MLC2	Curve multiplier at node N <sub>2</sub> , see Figure 5.2.
MLC3	Curve multiplier at node N <sub>3</sub> , see Figure 5.2.
MLC4	Curve multiplier at node N <sub>4</sub> , see Figure 5.2.
LOC	Application of surface for thermal shell elements, see parameter, THSHEL, in the *CONTROL_SHELL input: EQ.-1: lower surface of thermal shell element

---

<u>VARIABLE</u>	<u>DESCRIPTION</u>
	EQ.1: upper surface of thermal shell element
NHISV	Number of history variables associated with the flux definition: GT.0: A user defined subroutine will be called to compute the flux. See Remark 1.
HISV1	Initial value of history variable 1
HISV2	Initial value of history variable 2
.	
.	
HISVn	Initial value of history variable n, where n = NHISV

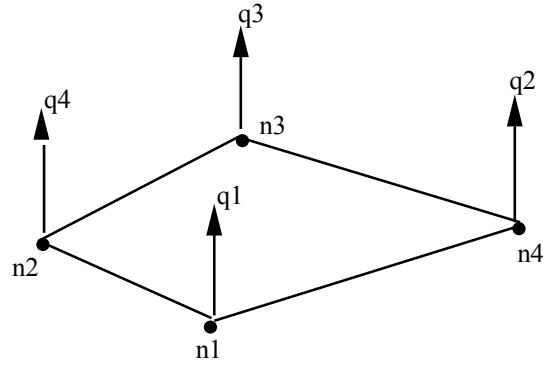
**Remarks:**

1. Flux can be defined by:
  - a) a constant baseline value defined by MLC1, MLC2, MLC3, MLC4
  - b) LCID – load curve id
  - c) FID – function id
  - d) user subroutine
2. If NHISV is a number greater than 0, the user subroutine  

```
subroutine usrflux(fl, flp, ...)
```

will be called to compute the flux (fl) defined as heat (energy) per time per surface area. For more details see Appendix S.
3. Three definitions for heat flux are possible. Heat flux can be a function of time, a function of temperature, or constant values that are maintained throughout the calculation. With the definition of multipliers at each node of the segment, a bilinear spatial variation can be assumed.

By convention, heat flow is negative in the direction of the surface outward normal vector. Surface definition is in accordance with the left hand rule. The outward normal vector points to the left as one progresses from node N<sub>1</sub>-N<sub>2</sub>-N<sub>3</sub>-N<sub>4</sub>. See Figure 5.2.



**Figure 5.2.** Nodal number determines outward normal.

4. This keyword is supported in the SPH elements to define the flux boundary conditions for a thermal or coupled thermal/structural analysis too. n1, n2, n3, n4 from the SPH particles or segments set defined from the SPH particles are used to define the flux segments.

# \*BOUNDARY

# \*BOUNDARY\_MCOL

## \*BOUNDARY\_MCOL

Purpose: Define parameters for MCOL coupling. The MCOL Program is a rigid body mechanics program for modeling the dynamics of ships. See Remark 1 for more information.

Card            1            2            3            4            5            6            7            8

Variable	NMCOL	MXSTEP	ENDTMCOL	TSUBC	PRTMCOL			
Type	I	I	F	F	F			
Default	2	none	0.0	0.0	none			
Remarks			2					

### Card 2 must be defined for each ship

Card 2            1                            2                            3            4            5

Variable	RBMCOL	MCOLFILE			
Type	I	A60			
Default		None			
Remarks					

### VARIABLE

### DESCRIPTION

NMCOL	Number of ships in MCOL coupling.
MXSTEP	Maximum of time step in MCOL calculation. If the number of MCOL time steps exceeds MXSTEP, then LS-DYNA will terminate.
ENDTMCOL	Uncoupling termination time, see Remark 2 below. EQ.0.0: set to LS-DYNA termination time

---

<u>VARIABLE</u>	<u>DESCRIPTION</u>
TSUBC	Time interval for MCOL subcycling. EQ.0.0: no subcycling
PRTMCOL	Time interval for output of MCOL rigid body data.
RBMCOL	LS-DYNA rigid body material assignment for the ship.
MCOLFILE	Filename containing MCOL input parameters for the ship.

**Remarks:**

1. The basis for MCOL is a convolution integral approach for simulating the equations of motion. A mass and inertia tensor are required as input for each ship. The masses are then augmented to include the effects of the mass of the surrounding water. A separate program determines the various terms of the damping/buoyancy force formulas which are also input to MCOL. The coupling is accomplished in a simple manner: at each time step LS-DYNA computes the resultant forces and moments on the MCOL rigid bodies and passes them to MCOL. MCOL then updates the positions of the ships and returns the new rigid body locations to LS-DYNA. A more detailed theoretical and practical description of MCOL can be found in a separate report (to appear).
2. After the end of the LS-DYNA / MCOL calculation, the analysis can be pursued using MCOL alone. ENDTMCOL is the termination time for this analysis. If ENDTMCOL is lower than the LS-DYNA termination time, the uncoupled analysis will not be activated.
3. The MCOL output is set to the files MCOLOUT (ship position) and MCOLENERGY (energy breakdown). In LS-PREPOST, MCOLOUT can be plotted through the rigid body time history option and MCOLENERGY.

# \*BOUNDARY

# \*BOUNDARY\_NON\_REFLECTING

## \*BOUNDARY\_NON\_REFLECTING

Purpose: Define a non-reflecting boundary. This option applies to continuum domains modeled with solid elements, as indefinite domains are usually not modeled. For geomechanical problems this option is important for limiting the size of the models.

Card 1            1            2            3            4            5            6            7            8

Variable	SSID	AD	AS					
Type	I	F	F					
Default	none	0.0	0.0					
Remarks	1, 2	3	3					

<u>VARIABLE</u>	<u>DESCRIPTION</u>
SSID	Segment set ID, see *SET_SEGMENT.
AD	Default activation flag for dilatational waves. EQ.0.0: on NE.0.0: off
AS	Default activation flag for shear waves. EQ.0.0: on NE.0.0: off

### Remarks:

1. Non-reflecting boundaries defined with this keyword are only used with three-dimensional solid elements. Boundaries are defined as a collection of segments, and segments are equivalent to element faces on the boundary. Segments are defined by listing the corner nodes in either a clockwise or counterclockwise order.
2. Non-reflecting boundaries are used on the exterior boundaries of an analysis model of an infinite domain, such as a half-space to prevent artificial stress wave reflections generated at the model boundaries from reentering the model and contaminating the results. Internally, LS-DYNA computes an impedance matching function for all non-reflecting boundary segments based on an assumption of linear material behavior. Thus, the finite



element mesh should be constructed so that all significant nonlinear behavior is contained within the discrete analysis model.

3. With the two optional switches, the influence of reflecting waves can be studied.
4. During the dynamic relaxation phase (optional), nodes on non-reflecting segments are constrained in the normal direction. Nodal forces associated with these constraints are then applied as external loads and held constant in the transient phase while the constraints are replaced with the impedance matching functions. In this manner, soil can be quasi-statically prestressed during the dynamic relaxation phase and dynamic loads (with non-reflecting boundaries) subsequently applied in the transient phase.

**\*BOUNDARY\_NON\_REFLECTING\_2D**

Purpose: Define a non-reflecting boundary. This option applies to continuum domains modeled with two-dimensional solid elements in the xy plane, as indefinite domains are usually not modeled. For geomechanical problems, this option is important for limiting the size of the models.

Card            1            2            3            4            5            6            7            8

Variable	NSID							
Type	I							
Default	none							
Remarks	1, 2							

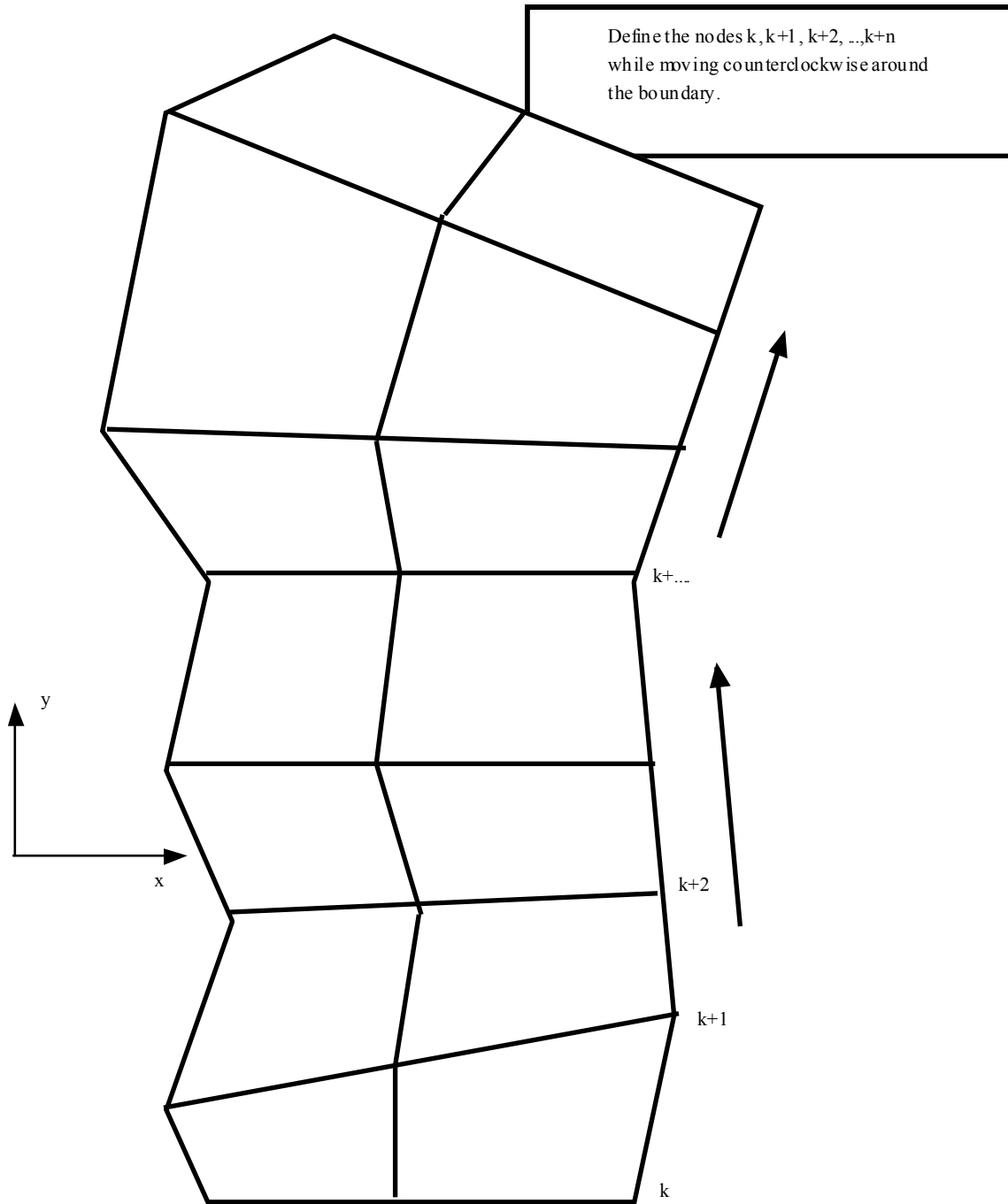
**VARIABLE****DESCRIPTION**

NSID

Node set ID, see \*SET\_NODE. See Figure 5.3.

**Remarks:**

1. Non-reflecting boundaries defined with this keyword are only used with two-dimensional solid elements in either plane strain or axisymmetric geometries. Boundaries are defined as a sequential string of nodes moving counterclockwise around the boundary.
2. Non-reflecting boundaries are used on the exterior boundaries of an analysis model of an infinite domain, such as a half-space to prevent artificial stress wave reflections generated at the model boundaries from reentering the model and contaminating the results. Internally, LS-DYNA computes an impedance matching function for all non-reflecting boundary segments based on an assumption of linear material behavior. Thus, the finite element mesh should be constructed so that all significant nonlinear behavior is contained within the discrete analysis model.



**Figure 5.3.** When defining a transmitting boundary in 2D define the node numbers in the node set in consecutive order while moving counterclockwise around the boundary.

**\*BOUNDARY\_PAP**

Purpose: Define pressure boundary conditions for pore air flow calculation, e.g. at structure surface exposed to atmospheric pressure.

Card 1            1            2            3            4            5            6            7            8

Variable	SEGID	LCID	CMULT	CVMASS	BLOCK	TBIRTH	TDEATH	
Type	I					F	F	
Default	none	none	none	none	0	0.0	1.e20	
Remarks				1,2				

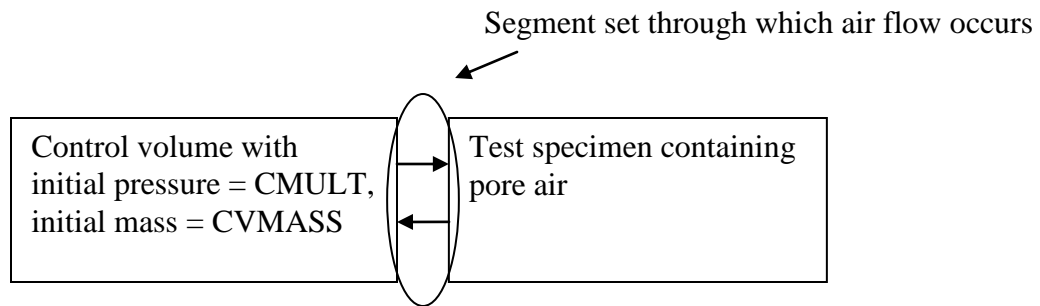
**VARIABLE****DESCRIPTION**

SEGID	Segment set ID
LCID	Load curve giving pore air pressure vs. time. EQ.0: constant pressure assumed equal to CMULT
CMULT	Factor on curve or constant pressure head if LCID=0
CVMASS	Initial mass of a control volume next to the segment set SETID
BLOCK	Contact blockage effect, EQ.0: When all segments in SEGID are subject to the pressure defined by LCID and CMULT; EQ.-1: When only elements in SEGID not involved in contact are subject to the pressure defined by LCID and CMULT.
TBIRTH	Time at which boundary condition becomes active
TDEATH	Time at which boundary condition becomes inactive

**Remarks:**

1. All structure surfaces subject to specified pressure have to be defined.
2. A non-zero CVMASS, together with a non-zero CMULT and an un-defined LCID, can be used to simulate air mass transfer between a control volume and a test specimen containing pore air. The control volume is assumed to have a fixed volume, and have

initial pressure of CMULT and initial mass of CVMASS. Air mass transfer happens between control volume and its neighboring specimen. Such mass transfer results in pressure change in control volume and test specimen.



# \*BOUNDARY

# \*BOUNDARY\_PORE\_FLUID

## \*BOUNDARY\_PORE\_FLUID\_OPTION

Available options include:

### PART

### SET

Purpose: Define parts that contain pore fluid. Defaults are given on \*CONTROL\_PORE\_FLUID.

Card 1            1            2            3            4            5            6            7            8

Variable	typeID	WTABLE	PF_RHO	ATYPE	PF_BULK	ACURVE	WTCUR	SUCLIM
Type	I	F	F	I	F	I	I	F
Default	none	*	*	*	*	0	0	0.

\* Defaults are taken from \*CONTROL\_PORE\_FLUID

<u>VARIABLE</u>	<u>DESCRIPTION</u>
PID, PSID	Part ID (PID) or Part set ID, see *PART and *SET_PART. All elements within the part must lie below the water table.
WTABLE	Z-coordinate at which pore pressure = 0 (water table)
PF_RHO	Density of pore water in soil skeleton: EQ.0: Default density specified on *CONTROL_PORE_FLUID card is used.
ATYPE	Analysis type for Parts: EQ.0: Default to value specified on *CONTROL_PORE_FLUID EQ 1: Undrained analysis EQ 2: Drained analysis EQ 3: Time dependent consolidation (coupled) EQ 4: Consolidate to steady state (uncoupled) EQ 5: Drained in dynamic relaxation, undrained in transient
PF_BULK	Bulk modulus of pore fluid: EQ.0: Default to value specified on *CONTROL_PORE_FLUID
ACURVE	Curve of analysis type vs time (see notes below)
WTCUR	Curve of water table (z-coordinate) vs time

---

<u>VARIABLE</u>	<u>DESCRIPTION</u>
SUCLIM	Suction limit (defined in head, i.e. length units). Must not be negative. See remarks.

**Remarks:**

This card must be present for all parts having pore water.

The density on this card is used only to calculate pressure head. To ensure the correct gravity loading, the density of the soil material should be increased to include the mass associated with the pore water.

The y-axis values of the curve of analysis type vs time can only be 1, 2 or 3. During dynamic relaxation, the analysis type will be taken from the first value on the curve

The default for SUCLIM is zero, meaning that the pore fluid cannot generate suction. To allow unlimited suction, set this parameter to a large positive number.

# \*BOUNDARY

# \*BOUNDARY\_PRECRACK

## \*BOUNDARY\_PRECRACK

Purpose: Define pre-cracks in fracture analysis.

Card 1            1            2            3            4            5            6            7            8

Variable	PID	CTYPE	NP					
Type	I	I	I					
Default		1						

Following cards give the coordinates of NP points defining the pre-crack:

Card            1            2            3            4            5            6            7            8

Variable	X	Y	Z					
Type	F	F	F					
Default								

### VARIABLE

### DESCRIPTION

PID	Part ID where the pre-crack is located
CTYPE	Type of pre-crack: EQ.1: straight line
NP	Number of points defining the pre-crack
X,Y,Z	Coordinates of the points defining the pre-crack



**\*BOUNDARY\_PRESCRIBED\_ACCELEROMETER\_RIGID**

Purpose: Prescribe the motion of a rigid body based on experimental data obtained from accelerometers affixed to the rigid body.

Note: This feature is available only in release R3 and higher of Version 971.

Card 1            1            2            3            4            5            6            7            8

Variable	PID	SOLV						
Type	I	I						
Default	none	1						

**Card 2, 3, 4, etc. Define one card for each accelerometer affixed to the rigid body. Input is terminated when a “\*” card is found. A minimum of three accelerometers are required (see Remarks below).**

Card            1            2            3            4            5            6            7            8

Variable	NID	CID	LCIDX	LCIDY	LCIDZ			
Type	I	I	I	I	I			
Default	none	none	none	none	none			

<u>VARIABLE</u>	<u>DESCRIPTION</u>
PID	Part ID for rigid body whose motion is prescribed.
SOLV	Solver type: EQ.1: Gaussian elimination (default), EQ.2: linear regression
NID	Node ID corresponding to the location of the accelerometer.
CID	Coordinate system ID describing the orientation of the accelerometer’s local axes (see *DEFINE_COORDINATE)_NODES). All nodes must reside on the same part. Set FLAG=1.

<u>VARIABLE</u>	<u>DESCRIPTION</u>
LCIDX	Load curve ID containing the local x-acceleration time history from the accelerometer.
LCIDY	Load curve ID containing the local y-acceleration time history from the accelerometer.
LCIDZ	Load curve ID containing the local z-acceleration time history from the accelerometer.

**Remarks:**

1. Acceleration time histories from a minimum of three accelerometers each providing output from three channels are required. Load curves must have the same number of points and data must be uniformly spaced.
2. Local axes of the accelerometers must be orthogonal.

**\*BOUNDARY\_PRESCRIBED\_FINAL\_GEOMETRY**

The final displaced geometry for a subset of nodal points is defined. The nodes of this subset are displaced from their initial positions specified in the \*NODE input to the final geometry along a straight line trajectory. A load curve defines a scale factor as a function of time that is bounded between zero and unity corresponding to the initial and final geometry, respectively. A unique load curve can be specified for each node, or a default load curve can apply to all nodes. The external work generated by the displacement field is included in the energy ratio calculation for the GLSTAT file.

Card 1            1            2            3            4            5            6            7            8

Variable	BPFGID	LCIDF	DEATHD						
Type	I	I	F						
Default	0	0	infinity						

**Card Format (I8,3E16.0,I8,E16.0) The next “\*” keyword card terminates this input.**

Card 2,...        1            2            3            4            5            6            7            8            9            10

Variable	NID	X	Y	Z	LCID	DEATH
Type	I	F	F	F	I	F
Default	none	0.	0.	0.	LCIDF	infinity

<u>VARIABLE</u>	<u>DESCRIPTION</u>
BPFGID	ID for this set of imposed boundary conditions
LCIDF	Default load curve ID. This curve varies between zero and unity.
DEATHD	Default death time. At this time the prescribed motion is inactive and the nodal point is allowed to move freely.
NID	Node ID for which the final position is defined. Nodes defined in this section must also appear under the *NODE input. .

<u>VARIABLE</u>	<u>DESCRIPTION</u>
X	x-coordinate of final geometry
Y	y-coordinate of final geometry
Z	z-coordinate of final geometry
LCID	Load curve ID. If zero the default curve ID, LCIDF, is used.
DEATH	Death time. If zero the default value, DEATHD, is used..



# \*BOUNDARY

# \*BOUNDARY\_PRESCRIBED\_MOTION

Card 1            1            2            3            4            5            6            7            8

Variable	typeID	DOF	VAD	LCID	SF	VID	DEATH	BIRTH
Type	I	I	I	I	F	I	F	F
Default	none	None	0	none	1.	0	1.E+28	0.0

**Card is required if DOF=9,10,11 on the first card or VAD=4. If DOF<9 and VAD<4, skip this card.**

Card 2            1            2            3            4            5            6            7            8

Variable	OFFSET1	OFFSET2	MRB	NODE1	NODE2			
Type	F	F	I	I	I			
Default	0.	0.	0	0	0			

## VARIABLE

## DESCRIPTION

ID	Optional PRESCRIBED MOTION set ID to which this node, node set, or rigid body belongs. This ID does not need to be unique.
HEADING	An optional descriptor for the given ID that will be written into the D3HSP file and the BNDOUT file.
typeID	Node ID (NID in *NODE), nodal set ID (SID in *SET_NODE) , or part ID (PID in *PART) for a rigid body.

VARIABLE	DESCRIPTION
DOF	<p>Applicable degrees-of-freedom:</p> <p>EQ.1: x-translational degree-of-freedom,  EQ.2: y-translational degree-of-freedom,  EQ.3: z-translational degree-of-freedom,  EQ.4: translational motion in direction given by the VID.  Movement on plane normal to the vector is permitted.  EQ.-4: translational motion in direction given by the VID.  Movement on plane normal to the vector is <u>not</u> permitted. This option does not apply to rigid bodies.  EQ.5: x-rotational degree-of-freedom,  EQ.6: y-rotational degree-of-freedom,  EQ.7: z-rotational degree-of-freedom,  EQ.8: rotational motion about a vector parallel to vector VID.  Rotation about the normal axes is permitted.  EQ.-8: rotational motion about a vector parallel to vector VID.  Rotation about the normal axes is <u>not</u> permitted. This option does not apply to rigid bodies.  EQ.9: y/z degrees-of-freedom for node rotating about the x-axis at location (OFFSET1,OFFSET2) in the yz-plane, point (y,z). Radial motion is NOT permitted. Not applicable to rigid bodies.  EQ.-9: y/z degrees-of-freedom for node rotating about the x-axis at location (OFFSET1,OFFSET2) in the yz-plane, point (y,z). Radial motion is permitted. Not applicable to rigid bodies.  EQ.10: z/x degrees-of-freedom for node rotating about the y-axis at location (OFFSET1,OFFSET2) in the zx-plane, point (z,x). Radial motion is NOT permitted. Not applicable to rigid bodies.  EQ.-10: z/x degrees-of-freedom for node rotating about the y-axis at location (OFFSET1,OFFSET2) in the zx-plane, point (z,x). Radial motion is permitted. Not applicable to rigid bodies.  EQ.11: x/y degrees-of-freedom for node rotating about the z-axis at location (OFFSET1,OFFSET2) in the xy-plane, point (x,y). Radial motion is NOT permitted. Not applicable to rigid bodies.  EQ.-11: x/y degrees-of-freedom for node rotating about the z-axis at location (OFFSET1,OFFSET2) in the xy-plane, point (x,y). Radial motion is permitted. Not applicable to rigid bodies.</p>
VAD	<p>Velocity/Acceleration/Displacement flag:</p> <p>EQ.0: velocity (rigid bodies and nodes),  EQ.1: acceleration (rigid bodies and nodes),  EQ.2: displacement (rigid bodies and nodes).  EQ.3: velocity versus displacement (rigid bodies and nodes)  EQ.4: relative displacement (rigid bodies only)</p>

<u>VARIABLE</u>	<u>DESCRIPTION</u>
LCID	Load curve ID to describe motion value versus time, see *DEFINE_CURVE, *DEFINE_CURVE_FUNCTION, or *DEFINE_FUNCTION. If LCID refers to *DEFINE_FUNCTION, the function can have only time as an argument, e.g., $f(t)=10.*t$ . See BIRTH below.
SF	Load curve scale factor. (default=1.0)
VID	Vector ID for DOF values of 4 or 8, see *DEFINE_VECTOR.
DEATH	Time imposed motion/constraint is removed: EQ.0.0: default set to $10^{28}$
BIRTH	Time imposed motion/constraint is activated starting from the initial abscissa value of the curve or function (*DEFINE_FUNCTION). Warning: BIRTH is ignored if the LCID is defined as a function, i.e., *DEFINE_CURVE_FUNCTION.
OFFSET1	Offset for DOF types 9-11 (y, z, x direction)
OFFSET2	Offset for DOF types 9-11 (z, x, y direction)
MRB	Master rigid body for measuring the relative displacement.
NODE1	Optional orientation node, n1, for relative displacement
NODE2	Optional orientation node, n2, for relative displacement

**Remarks:**

When DOF=5, 6, 7, or 8, nodal rotational degrees-of-freedom are prescribed in the case of deformable nodes (*OPTION1*=NODE or SET) whereas body rotations are prescribed in the case of a rigid body (*OPTION1*=RIGID). In the case of a rigid body, the axis of prescribed rotation always passes through the body's center of mass. For  $|\text{DOF}|=8$ , the axis of the prescribed rotation is parallel to vector VID. To prescribe a body rotation of a set of deformable nodes, with the axis of rotation parallel to global axes x, y, or z, use *OPTION1*=SET with  $|\text{DOF}| = 9, 10, \text{ or } 11$ , respectively. The load curve scale factor can be used for simple modifications or unit adjustments.

The relative displacement can be measured in either of two ways:

1. Along a straight line between the mass centers of the rigid bodies,
2. Along a vector beginning at node n1 and terminating at node n2.







**\*BOUNDARY\_PRESCRIBED\_ORIENTATION\_RIGID\_OPTION**

Available options include:

**DIRCOS**

**ANGLES**

**EULERP**

**VECTOR**

Purpose: Prescribe the orientation of rigid body as a function of time. .

**Card Formats:**

Card 1 is common to all orientation methods.  
Cards 2 to 3 are unique for each orientation method.

**Required for all orientation methods.**

Card 1            1            2            3            4            5            6            7            8

Variable	PIDB	PIDA	INTRP	BIRTH	DEATH			
Type	I	I	I	F	F			
Default	none	0	1	0.	1.e20			

**VARIABLE**

**DESCRIPTION**

PIDB	Part ID for rigid body B whose orientation is prescribed.
PIDA	Part ID for rigid body A. If zero then orientation of PIDB is performed with respect to the global reference frame.
INTRP	Interpolation method used on time history curves: EQ.1: linear interpolation (default) EQ.2: cubic spline interpolation
BIRTH	Prior to this time the body moves freely under the action of other agents.
DEATH	The body is freed at this time and subsequently allowed to move under the action of other agents.

**Card 2 of 3 - Required for DIRCOS option.**

Card 2            1            2            3            4            5            6            7            8

Variable	LCIDC11	LCIDC12	LCIDC13	LCIDC21	LCIDC22	LCIDC23	LCIDC31	LCIDC32
Type	I	I	I	I	I	I	I	I
Default	none	none	None	none	none	none	none	none

Card 3            1            2            3            4            5            6            7            8

Variable	LCIDC33							
Type	I							
Default	none							

**VARIABLE**

**DESCRIPTION**

LCIDCij

Load curve ID specifying direction cosine  $C_{ij}$  as a function of time.  $C_{ij}$  is defined as:

$$C_{ij} \triangleq \mathbf{a}_i \cdot \mathbf{b}_j$$

where  $\mathbf{a}_i$  ( $i=1,2,3$ ) are mutually perpendicular unit vectors fixed in PIDA and  $\mathbf{b}_j$  ( $j=1,2,3$ ) are mutually perpendicular unit vectors fixed in PIDB. If PIDA=0 then  $\mathbf{a}_j$  ( $j=1,2,3$ ) are unit vectors aligned, respectively, with the global axes X, Y, and Z. See Remark 1.

**Card 2 - Required for ANGLES option.**

Card 2            1            2            3            4            5            6            7            8

Variable	LCIDQ1	LCIDQ2	LCIDQ3	ISEQ	ISHFT	BODY		
Type	I	I	I	I	I	I		
Default	none	none	none	none	1	0		

<u>VARIABLE</u>	<u>DESCRIPTION</u>
-----------------	--------------------

LCIDQi	Load curve ID specifying the orientation angle $q_i$ as a function of time. See Remark 1 and 2.
--------	---

ISEQ	<p>Specifies the sequence in which the rotations are effected. In this first set of sequences three unique axes are involved.</p> <p>EQ.123: the first rotation is performed about the x axis an amount <math>q_1</math>, the second about the y axis an amount <math>q_2</math> and the third about the z axis an amount <math>q_3</math>.</p> <p>EQ.231: the first rotation is performed about the y axis an amount <math>q_1</math>, the second about the z axis an amount <math>q_2</math> and the third about the x axis an amount <math>q_3</math>.</p> <p>EQ.312: the first rotation is performed about the z axis an amount <math>q_1</math>, the second about the x axis an amount <math>q_2</math> and the third about the y axis an amount <math>q_3</math>.</p> <p>EQ.132: the first rotation is performed about the x axis an amount <math>q_1</math>, the second about the z axis an amount <math>q_2</math> and the third about the y axis an amount <math>q_3</math>.</p> <p>EQ.213: the first rotation is performed about the y axis an amount <math>q_1</math>, the second about the x axis an amount <math>q_2</math> and the third about the z axis an amount <math>q_3</math>.</p> <p>EQ.321: the first rotation is performed about the z axis an amount <math>q_1</math>, the second about the y axis an amount <math>q_2</math> and the third about the x axis an amount <math>q_3</math>.</p> <p>The second set of sequences involve only two unique axes where the first and third are repeated.</p> <p>EQ.121: the first rotation is performed about the x axis an amount <math>q_1</math>, the second about the y axis an amount <math>q_2</math> and the third about the x axis an amount <math>q_3</math>.</p> <p>EQ.131: the first rotation is performed about the x axis an amount <math>q_1</math>, the second about the z axis an amount <math>q_2</math> and the third about the x axis an amount <math>q_3</math>.</p> <p>EQ.212: the first rotation is performed about the y axis an amount <math>q_1</math>, the</p>
------	---

<u>VARIABLE</u>	<u>DESCRIPTION</u>
	<p>second about the x axis an amount <math>q_2</math> and the third about the y axis an amount <math>q_3</math>.</p> <p>EQ.232: the first rotation is performed about the y axis an amount <math>q_1</math>, the second about the z axis an amount <math>q_2</math> and the third about the y axis an amount <math>q_3</math>.</p> <p>EQ.313: the first rotation is performed about the z axis an amount <math>q_1</math>, the second about the x axis an amount <math>q_2</math> and the third about the z axis an amount <math>q_3</math>.</p> <p>EQ.323: the first rotation is performed about the z axis an amount <math>q_1</math>, the second about the x axis an amount <math>q_2</math> and the third about the z axis an amount <math>q_3</math>.</p>
ISHFT	<p>Angle shift.</p> <p>EQ.1: Angle curves are unaltered.</p> <p>EQ.2: Shifts angle data in the LCIDQi curves as necessary to eliminate discontinuities. If angles are confined to the range <math>[-\pi, \pi]</math> and the data contains excursions exceeding <math>\pi</math> then set ISHFT=2.</p>
BODY	<p>Reference axes.</p> <p>EQ.0: Rotations are performed about axes fixed in PIDA.</p> <p>EQ.1: Rotations are performed about axes fixed in PIDB.</p>

**Card 2 - Required for EULERP option.**

Card 2	1	2	3	4	5	6	7	8
Variable	LCIDE1	LCIDE2	LCIDE3	LCIDE4				
Type	I	I	I	I				
Default	none	none	none	none				

<u>VARIABLE</u>	<u>DESCRIPTION</u>
LCIDEi	<p>Load curve ID specifying Euler parameter <math>e_i</math> as a function of time. The Euler parameters are defined as follows. See Remark 1.</p> $\varepsilon_i \triangleq \varepsilon \cdot \mathbf{a}_i = \varepsilon \cdot \mathbf{b}_i \quad (i = 1,2,3)$ $\varepsilon_4 \triangleq \cos\left(\frac{\theta}{2}\right)$ <p>where <math>\varepsilon</math> is the Euler vector, <math>\mathbf{a}_i</math> and <math>\mathbf{b}_i</math> (<math>i=1,2,3</math>) are dextral sets of unit vectors fixed in PIDA and PIDB, respectively, and <math>\theta</math> is the angle</p>

**VARIABLE**

**DESCRIPTION**

associated with the rotation of PIDB in PIDA about Euler vector. If PIDA=0 then  $\mathbf{a}_j$  (j=1,2,3) are unit vectors aligned, respectively, with the global axes X, Y, and Z.

**Card 2 - Required for VECTOR option.**

Card 2            1            2            3            4            5            6            7            8

Variable	LCIDV1	LCIDV2	LCIDV3	LCIDS	VALSPIN			
Type	I	I	I	I	F			
Default	none	none	none	0	0.			

**VARIABLE**

**DESCRIPTION**

LCIDVi            Load curve ID specifying the vector measure number  $v_i$  as a function of time. The vector measure numbers are defined as follows. See remark 1.  

$$v_i \triangleq \mathbf{v} \cdot \mathbf{n}_i \quad (i = 1,2,3)$$
 where  $\mathbf{v}$  is a vector and  $\mathbf{n}_i$  (i=1,2,3) are unit vectors aligned, respectively, with the global axes X, Y, and Z.

LCIDS            Load curve ID which specifies the spin speed of PIDB about an axis parallel to the vector.  
 EQ.0: a constant spin speed as defined by VALSPIN is used,  
 EQ.n: spin speed (radians per unit time) is given by load curve n.

VALSPIN            Value for constant the spin speed of PIDB (radians per unit time). This option is bypassed if the load curve number defined above is non-zero.

**Remarks:**

1. All load curves must contain the same number of points and the data must be uniformly spaced.
2. Angles are specified in radians.
3. LC0 in \*MAT\_RIGID should be used to identify a coordinate system for each rigid body. The coordinate system must be defined with \*DEFINE\_COORDINATE\_NODES and FLAG=1, Nodes used in defining the coordinate system must reside on the same body.

# \*BOUNDARY

# \*BOUNDARY\_PRESSURE\_OUTFLOW

## \*BOUNDARY\_PRESSURE\_OUTFLOW\_OPTION

Available options include:

### SEGMENT

### SET

Purpose: Define pressure outflow boundary conditions. These boundary conditions are attached to solid elements using the Eulerian ambient formulation (refer to ELFORM in \*SECTION\_SOLID\_ALE) and defined to be pressure outflow ambient elements (refer to AET in \*SECTION\_SOLID\_ALE).

**For the SET option define the following card**

Card 1            1            2            3            4            5            6            7            8

Variable	SSID								
Type	I								
Default	none								

**For the SEGMENT option define the following card**

Card 1            1            2            3            4            5            6            7            8

Variable	N1	N2	N3	N4					
Type	I	I	I	I					
Default	none	none	none	none					

### VARIABLE

### DESCRIPTION

SSID

Segment set ID

N1,N2...

Node ID's defining segment



**\*BOUNDARY\_PWP\_OPTION**

Available options include:

- NODE**
- SET**
- TABLE**
- TABLE\_SET**

Purpose: Define pressure boundary conditions for pore water, e.g. at soil surface. The TABLE option applies to a whole Part, while the other options apply to specified nodes.

Card 1            1            2            3            4            5            6            7            8

Variable	typeID	LC	CMULT	LCDR	TBIRTH	TDEATH		
Type	I	F	F	I	F	F		
Default	none	none	0.0	None	0.0	1.0e20		

Card 2            1            2            3            4            5            6            7            8

Variable	IPHRE	ITOTEX	IDRFLAG	TABLE				
Type	I	I	I	I				
Default	0	0	0	0				

<u>VARIABLE</u>	<u>DESCRIPTION</u>
typeID	Node ID (option=NODE) or Node set ID (option=SET) or Part ID (option=TABLE) or Part Set ID (option=TABLE_SET)
LC	Load curve giving pore water pressure head (length units) vs time. EQ.0: constant pressure head assumed equal to CMULT (leave blank for TABLE option)
CMULT	Factor on curve or constant pressure head if LC=0
LCDR	Load curve giving pore water pressure head during dynamic relaxation.

<b>VARIABLE</b>	<b>DESCRIPTION</b>
	EQ.0: during D.R, use first pressure head value on LC (leave blank for TABLE option)
TBIRTH	Time at which boundary condition becomes active
TDEATH	Time at which boundary condition becomes inactive
IPHRE	Flag EQ.1 for phreatic behaviour (water can be removed by the boundary condition but not added, e.g. at a sloping free surface). Not applicable to TABLE option
ITOTEX	Flag for type of pressure boundary condition: (see notes) EQ.0: Total head EQ.1: Excess head EQ.2: Hydraulic head EQ.4: Z-coord where head=0 (piezometric level)
IDRFLAG	Active flag: EQ.0: Active only in transient analysis EQ.1: Active only in dynamic relaxation EQ.2: Active in all analysis phases (leave blank for TABLE option)
TABLE	Table ID for TABLE option only. See notes below.

**Remarks:**

Pressure is given as pressure head, i.e. pressure/ $\rho g$ .

NODE and SET options do not affect the pore pressure in Drained parts (the pore pressure for these is set on a part basis and overrides any nodal boundary conditions). The TABLE option should be used only with Drained parts.

TABLE and TABLE\_SET options: The table consists of a list of times in ascending order, followed immediately by curves of z-coordinate versus pore pressure head. Each curve represents the pore water pressure head distribution with z-coordinate at the corresponding time. There must be the same number of curves as time values, arranged immediately after the \*DEFINE\_TABLE and in the correct order to correspond to the time values. Each curve should be arranged in ascending order of z-coordinate – they look upside-down on the page. The z-coordinate is the x-axis of the curve, the pore water pressure head (in length units) is the y-axis. Each curve should have the same z-coordinates (x-values). Ensure that the range of z-coordinates in the curve exceeds by at least 5% the range of z-coordinates of the nodes belonging to the parts to which the boundary condition is applied.

“Phreatic” means that water can be removed by the boundary condition but not added. The boundary condition enforces that the pressure head be less than or equal to the stated value. This condition occurs when the free surface of the soil is sloping so that any water emerging from the soil runs away down the slope.

ITOTEX=0: value from curve or table is total head. This may be used with any pore pressure analysis type.

ITOTEX=1: value from curve or table is excess head. Total head will be determined by adding the hydrostatic head. This option cannot be used with drained analysis, which sets excess head to zero.

ITOTEX=2: value from curve or table is hydraulic head, to which excess head may be added due to volume change in the soil if the analysis type is not drained.

ITOTEX=4: the curve value is the z-coordinate of the water surface; pore pressure head at any node in this boundary condition is given by  $(z_{\text{surface}} - z_{\text{node}})$ . This option allows a single boundary condition to be used for nodes at any depth, provided that the pressure distribution is hydrostatic below the given surface. This option is not available for the TABLE option.

\*BOUNDARY\_PWP\_NODE or SET overrides pressure head from

\*BOUNDARY\_PWP\_TABLE at nodes where both are present.

**\*BOUNDARY\_RADIATION\_OPTION1\_{OPTION2}**

OPTION1 specifies radiation boundary surface definition by a surface set (**SET**) or by a segment list (**SEGMENT**).

OPTION2 indicates the radiation boundary surface is part of an enclosure. OPTION2 specifies the use of view factors (**VF**) or exchange factors (**EF**) for the radiation calculations. The suffix (**READ**) indicates that the view factors should be read from the file “**viewfl**” or exchange factors from the file “**exchfl**”. The suffix (**CALCULATE**) indicates that the view factors or exchange factors should be calculated. The Stefan Boltzmann constant must be defined for radiation in an enclosure. See **\*CONTROL\_THERMAL\_SOLVER**.

A list of acceptable keywords are:

**\*BOUNDARY\_RADIATION\_SEGMENT**

**\*BOUNDARY\_RADIATION\_SEGMENT\_VF\_READ**

**\*BOUNDARY\_RADIATION\_SEGMENT\_VF\_CALCULATE**

**\*BOUNDARY\_RADIATION\_SET**

**\*BOUNDARY\_RADIATION\_SET\_VF\_READ**

**\*BOUNDARY\_RADIATION\_SET\_VF\_CALCULATE**

**\*BOUNDARY\_RADIATION\_SET\_EF\_READ**

**\*BOUNDARY\_RADIATION\_SET\_EF\_CALCULATE**

**\*BOUNDARY\_RADIATION\_SEGMENT**

Include the following 2 cards for each segment. This keyword defines surface segments that transfer energy by radiation to the environment. Setting TYPE=1 on Card 1 below indicates that the segment transfers energy to the environment.

Card 1            1            2            3            4            5            6            7            8

Variable	N1	N2	N3	N4	TYPE			
Type	I	I	I	I	I			
Default	none	none	none	none	1			

Card 2            1            2            3            4            5            6            7            8

Variable	FLCID	FMULT	TILCID	TIMULT	LOC			
Type	I	F	I	F	I			
Default	none	0.	none	0.	0			

**\*BOUNDARY\_RADIATION\_SEGMENT\_VF\_OPTION**

Available options include:

**READ**  
**CALCULATE**

Include the following 2 cards for each segment. This keyword defines surface segments that transfer energy by radiation within an enclosure using view factors. Setting TYPE=2 on Card 1 below specifies that the segment belongs to an enclosure. The file “viewfl” must be present for the **READ** option. The file “viewfl” will be created for the **CALCULATE** option. If the file “viewfl” exists when using the **CALCULATE** option, LS-DYNA will terminate with an error message to prevent overwriting the file. The format of “viewfl” is defined at the end of this section.

Card 1            1            2            3            4            5            6            7            8

Variable	N1	N2	N3	N4	TYPE	BLOCK	NINT	
Type	I	I	I	I	I	I	I	
Default	none	none	none	none	2	0	0	

Card 2            1            2            3            4            5            6            7            8

Variable	SELCID	SEMULT						
Type	I	F						
Default	none	0.						

**\*BOUNDARY\_RADIATION\_SET**

Include the following 2 cards for each set. This keyword defines surface segment sets that transfer energy by radiation to the environment. Setting TYPE=1 on Card 1 below indicates that the segment transfers energy to the environment.

Card 1            1            2            3            4            5            6            7            8

Variable	SSID	TYPE						
Type	I	I						
Default	none	1						

Card 2            1            2            3            4            5            6            7            8

Variable	FLCID	FMULT	TILCID	TIMULT	LOC			
Type	I	F	I	F	I			
Default	none	0.	none	0.	0			

# \*BOUNDARY

# \*BOUNDARY\_RADIATION\_SET

## \*BOUNDARY\_RADIATION\_SET\_VF\_READ

## \*BOUNDARY\_RADIATION\_SET\_VF\_CALCULATE

Include the following 2 cards for each set. This keyword defines surface segment sets that transfer energy by radiation within an enclosure using view factors. Setting TYPE=2 on Card 1 below specifies that the segment set belongs to an enclosure. The file “viewfl” must be present for the **READ** option. The file “viewfl” will be created for the **CALCULATE** option. If the file “viewfl” exists when using the **CALCULATE** option, LS-DYNA will terminate with an error message to prevent overwriting the file. The format of “viewfl” is defined at the end of this section.

Card 1            1            2            3            4            5            6            7            8

Variable	SSID	TYPE	RAD_GRP	FILE_NO	BLOCK	NINT		
Type	I	I	I	I	I	I		
Default	none	2	0	0	0	0		

Card 2            1            2            3            4            5            6            7            8

Variable	SELCID	SEMULT						
Type	I	F						
Default	none	0.						



**\*BOUNDARY\_RADIATION\_SET\_EF\_READ**

**\*BOUNDARY\_RADIATION\_SET\_EF\_CALCULATE**

Include the following card for each set. This keyword defines surface segment sets that transfer energy by radiation within an enclosure using exchange factors. The file “exchfl” must be present for the **READ** option. The file “exchfl” will be created for the **CALCULATE** option. If the file “exchfl” exists when using the **CALCULATE** option, LS-DYNA will terminate with an error message to prevent overwriting the file. The format of “exchfl” is defined at the end of this section.

Card 1            1            2            3            4            5            6            7            8

Variable	SSID	NMAT	NPHT	ERRMAX				
Type	I	I	I	I				
Default	none	none	1	1.0e-02				

<u>VARIABLE</u>	<u>DESCRIPTION</u>
BLOCK	Flag indicating if this surface blocks the view between any other 2 surfaces. EQ.0: no blocking (default) EQ.1: blocking
ERRMAX	ERRMAX is the convergence error tolerance for the surface.
FILE_NO	File number for view factor file. FILE_NO is added to <b>viewfl_</b> to form the name of the file containing the view factors. For example if FILE_NO is specified as 22, then the view factors are read from <b>viewfl_22</b> . For radiation enclosure group zero FILE_NO is ignored and view factors are read from <b>viewfl</b> . The same file may be used for different radiation enclosure group definitions.
LOC	Shell surface flag for thermal shell elements. See the parameter THSHEL on the <b>*CONTROL_SHELL</b> keyword. EQ.-1: lower surface of thermal shell element EQ. 1: upper surface of thermal shell element
N1, N2, N3, N4	Node ID's defining segment

<b>VARIABLE</b>	<b>DESCRIPTION</b>
NINT	Number of integration points for viewfactor calculation EQ.0: LS-DYNA determines the number of integration points based on the segment size and separation distance $1 \leq \text{NINT} \leq 10$ : User specified number
NMAT	NMAT specifies the material type for the portion of the boundary specified by SSID. NMAT must be an exchange factor material ID. See the *EF_MATERIAL keyword.
NPHT	The segments specified by SSID will emit NPHT*NPHOTON photons. See the *EF_CONTROL keyword.
RAD_GRP	Radiation enclosure group ID. The segment sets from all radiation enclosure definitions with the same group ID are augmented to form a single enclosure definition. If RAD_GRP is not specified or set to zero, then the segments are placed in group zero. All segments defined by the SEGMENT option are placed in set zero.
FLCID	Load curve ID for radiation factor f, see *DEFINE_CURVE GT.0: function versus time EQ.0: use constant multiplier value, FMULT LT.0: function versus temperature
FMULT	Curve multiplier for f for use in the equation $\dot{q}'' = \sigma \varepsilon F (T_2^4 - T_1^4) = f (T_{\text{surface}}^4 - T_{\infty}^4)$
SELCID	Load curve ID for surface emissivity, see *DEFINE_CURVE GT.0: function versus time EQ.0: use constant multiplier value, SEMULT LT.0: function versus temperature
SEMULT	Curve multiplier for surface emissivity, see *DEFINE_CURVE
SSID	SSID specifies the ID for a set of segments that comprise a portion of, or possibly, the entire enclosure. See *SET_SEGMENT.
TILCID	Load curve ID for $T_{\infty}$ versus time, see *DEFINE_CURVE: EQ.0: use constant multiplier, TIMULT
TIMULT	Curve multiplier for $T_{\infty}$
TYPE	Radiation type: EQ.1: Radiation to environment EQ.2: Radiation within an enclosure



**\*BOUNDARY\_SLIDING\_PLANE**

Purpose: Define a sliding symmetry plane. This option applies to continuum domains modeled with solid elements.

Card            1            2            3            4            5            6            7            8

Variable	NSID	VX	VY	VZ	COPT			
Type	I	F	F	F	I			
Default	none	0	0	0	0			

**VARIABLE****DESCRIPTION**

NSID	Nodal set ID, see *SET_NODE
VX	x-component of vector defining normal or vector
VY	y-component of vector defining normal or vector
VZ	z-component of vector defining normal or vector
COPT	Option: EQ.0: node moves on normal plane, EQ.1: node moves only in vector direction.

**Remarks:**

Any node may be constrained to move on an arbitrarily oriented plane or line depending on the choice of COPT. Each boundary condition card defines a vector originating at (0,0,0) and terminating at the coordinates defined above. Since an arbitrary magnitude is assumed for this vector, the specified coordinates are non-unique and define only a direction. Use of \*BOUNDARY\_SPC is preferred over \*BOUNDARY\_SLIDING\_PLANE as the boundary conditions imposed via the latter have been seen to break down somewhat in lengthy simulations owing to numerical roundoff.



Card 1            1            2            3            4            5            6            7            8

Variable	NID/NSID	CID	DOFX	DOFY	DOFZ	DOFRX	DOFRY	DOFRZ
Type	I	I	I	I	I	I	I	I
Default	none	0	0	0	0	0	0	0

**Read this card if the BIRTH\_DEATH option is active.**

Card opt.        1            2            3            4            5            6            7            8

Variable	BIRTH	DEATH						
Type	F	F						
Default	0.0	1.E+20						

**VARIABLE****DESCRIPTION**

ID	Optional SPC set ID to which this node or node set belongs. This ID does not need to be unique
HEADING	An optional SPC descriptor that will be written into the D3HSP file and the SPCFORC file.
NID/NSID	Node ID or nodal set ID, see *SET_NODE.
CID	Coordinate system ID, see *DEFINE_COORDINATE_SYSTEM.
DOFX	Insert 1 for translational constraint in local x-direction.
DOFY	Insert 1 for translational constraint in local y-direction.
DOFZ	Insert 1 for translational constraint in local z-direction.
DOFRX	Insert 1 for rotational constraint about local x-axis.
DOFRY	Insert 1 for rotational constraint about local y-axis.



**\*BOUNDARY\_SPH\_FLOW**

Purpose: Define a flow of particles. This option applies to continuum domains modeled with SPH elements.

Card 1            1            2            3            4            5            6            7            8

Variable	ID	STYP	DOF	VAD	LCID	SF	DEATH	BIRTH
Type	I	I	I	I	I	F	F	F
Default	none	none	None	0	none	1.	1.E+20	0.0

Card 2            1            2            3            4            5            6            7            8

Variable	NODE	VID						
Type	I	I						
Default	none	0						

**VARIABLE****DESCRIPTION**

NSID, PID

Nodal set ID (NSID), SEE \*SET\_NODE, or part ID (PID), see \*PART.

STYP

Set type:

EQ.1: part set ID, see \*SET\_PART,

EQ.2: part ID, see \*PART,

EQ.3: node set ID, see \*NODE\_SET,

DOF

Applicable degrees-of-freedom:

EQ.1: x-translational degree-of-freedom,

EQ.2: y-translational degree-of-freedom,

EQ.3: z-translational degree-of-freedom,

EQ.4: translational motion in direction given by the VID.

Movement on plane normal to the vector is permitted.

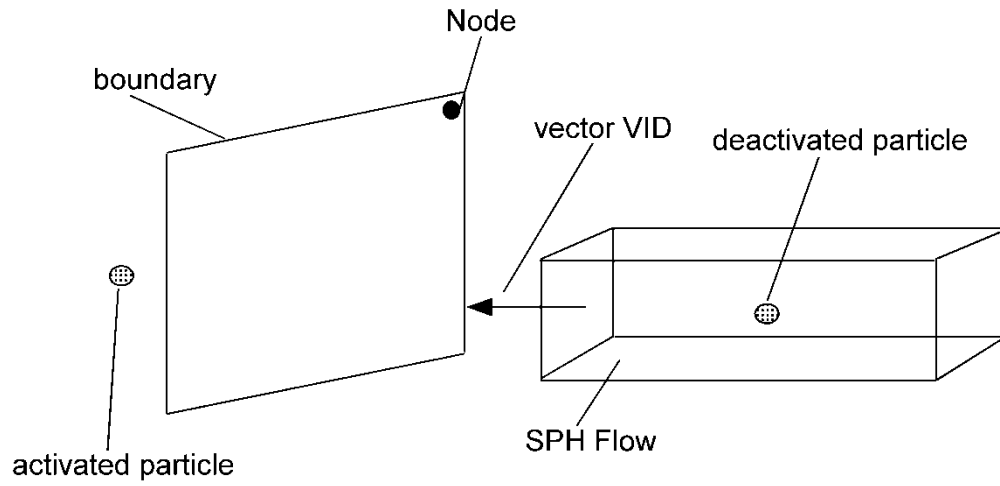


---

<u>VARIABLE</u>	<u>DESCRIPTION</u>
VAD	Velocity/Acceleration/Displacement flag applied to SPH elements before activation: EQ.0: velocity, EQ.1: acceleration, EQ.2: displacement.
LCID	Load curve ID to describe motion value versus time, see *DEFINE_CURVE.
SF	Load curve scale factor. (default=1.0)
DEATH	Time imposed motion/constraint is removed: EQ.0.0: default set to $10^{20}$ .
BIRTH	Time imposed motion/constraint is activated.
NODE	Node fixed in space which determines the boundary between activated particles and deactivated particles.
VID	Vector ID for DOF value of 4, see *DEFINE_VECTOR

**Remarks:**

Initially, the user defines the set of particles that are representing the flow of particles during the simulation. At time  $t=0$ , all the particles are deactivated which means that no particle approximation is calculated. The boundary of activation is a plane determined by the NODE, and normal to the vector VID. The particles are activated when they reached the boundary. Since they are activated, particle approximation is started.



**Figure 5.4.** Vector **VID** determines the orientation of the SPH flow.

**\*BOUNDARY\_SPH\_SYMMETRY\_PLANE**

Purpose: Define a symmetry plane for SPH. This option applies to continuum domains modeled with SPH elements.

Card            1            2            3            4            5            6            7            8

Variable	VTX	VTY	VTZ	VHX	VHY	VHZ		
Type	F	F	F	F	F	F		
Default	0.	0.	0.	0.	0.	0.		

**VARIABLE****DESCRIPTION**

VTX	x-coordinate of tail of a normal vector originating on the wall (tail) and terminating in the body (head) (i.e., vector points from the symmetry plane into the body).
VTY	y-coordinate of tail
VTZ	z-coordinate of tail
VHX	x-coordinate of head
VHY	y-coordinate of head
VHZ	z-coordinate of head

**Remarks:**

1. A plane of symmetry is assumed for all SPH elements defined in the model.
2. The plane of symmetry has to be normal to either the x, y or z direction.

# \*BOUNDARY

# \*BOUNDARY\_SYMMETRY\_FAILURE

## \*BOUNDARY\_SYMMETRY\_FAILURE

Purpose: Define a symmetry plane with a failure criterion. This option applies to continuum domains modeled with solid elements.

Card            1            2            3            4            5            6            7            8

Variable	SSID	FS	VTX	VTY	VTZ	VHX	VHY	VHZ
Type	I	F	F	F	F	F	F	F
Default	none	0.	0.	0.	0.	0.	0.	0.

### VARIABLE

### DESCRIPTION

SSID	Segment set ID, see *SET_SEGMENT
FS	Tensile failure stress > 0.0. The average stress in the elements surrounding the boundary nodes in a direction perpendicular to the boundary is used.
VTX	x-coordinate of tail of a normal vector originating on the wall (tail) and terminating in the body (head) (i.e., vector points from the symmetry plane into the body).
VTY	y-coordinate of tail
VTZ	z-coordinate of tail
VHX	x-coordinate of head
VHY	y-coordinate of head
VHZ	z-coordinate of head

### Remarks:

A plane of symmetry is assumed for the nodes on the boundary at the tail of the vector given above. Only the motion perpendicular to the symmetry plane is constrained. After failure the nodes are set free.

**\*BOUNDARY\_TEMPERATURE\_OPTION**

Available options include:

**NODE**

**SET**

Purpose: Define temperature boundary conditions for a thermal or coupled thermal/structural analysis.

Card            1            2            3            4            5            6            7            8

Variable	NID/SID	LCID	CMULT	LOC	FID			
Type	I	I	F	I				
Default	none	0	0.	0				

<u>VARIABLE</u>	<u>DESCRIPTION</u>
NID/SID	Node ID/Node Set ID, see *SET_NODE_OPTION
LCID	Load curve ID for temperature versus time: EQ.0: use the constant multiplier value given below by CMULT.
CMULT	Curve multiplier for temperature
LOC	Application of surface for thermal shell elements, see parameter, THSHEL, in the *CONTROL_SHELL input: EQ.-1: lower surface of thermal shell element EQ.0: middle surface of thermal shell element EQ.1: upper surface of thermal shell element
FID	Function ID

**Remarks:**

If no load curve ID is given, then a constant boundary temperature is assumed. CMULT is also used to scale the load curve values. This keyword can be used to apply temperature boundary conditions for SPH particles too.

# \*BOUNDARY

# \*BOUNDARY\_THERMAL\_WELD

## \*BOUNDARY\_THERMAL\_WELD

Purpose: Define a moving heat source to model welding. Only applicable for a coupled thermal-structural simulations in which the weld source or work piece is moving.

Card 1            1            2            3            4            5            6            7            8

Variable	PID	PTYP	NID	NFLAG	X0	Y0	Z0	N2ID
Type	I	I	I	I	F	F	F	I
Default	none	1	none	1	none	none	none	none

Card 2            1            2            3            4            5            6            7            8

Variable	a	b	cf	cr	LCID	Q	Ff	Fr
Type	F	F	F	F	I	F	F	F
Default	none	none	none	none	none	none	none	none

### Optional Card 3 Format (define this card only if N2ID = -1 on card 1 above)

Card 3            1            2            3            4            5            6            7            8

Variable	tx	ty	tz					
Type	F	F	F					
Default	none	none	none					

### VARIABLE

### DESCRIPTION

PID

Part ID or Part Set ID to which weld source is applied

VARIABLE	DESCRIPTION
PTYP	PID type: EQ.1: PID defines a single part ID EQ.2: PID defines a part set ID
NID	Node ID giving location of weld source EQ.0: location defined by (X0,Y0,Z0) below
NFLAG	Flag controlling motion of weld source EQ.1: source moves with node NID EQ.2: source is fixed in space at original position of node NID
X0,Y0,Z0	Coordinates of weld source, which remains fixed in space (optional, ignored if NID nonzero above)
N2ID	Second node ID for weld beam aiming direction GT.0: beam is aimed from N2ID to NID, moves with these nodes EQ.-1: beam aiming direction is (tx,ty,tz) input on optional card 3
a	Weld pool width
b	Weld pool depth (in beam aiming direction)
cf	Weld pool forward direction
cr	Weld pool rearward direction
LCID	Load curve ID for weld energy input rate vs. time EQ.0: use constant multiplier value Q.
Q	Curve multiplier for weld energy input rate [energy/time, e.g., Watt]
Ff	Forward distribution function
Fr	Rear distribution function (Note: $F_f + F_r = 2.0$ )
tx,ty,tz	Weld beam direction vector in global coordinates (N2ID = -1 only)

**Remarks:**

This boundary condition allows simulation of a moving weld heat source, following the work of Goldak, Chakravarti, and Bibby [1984]. Heat is generated in an ellipsoidal region centered at the weld source, and decaying exponentially with distance according to:

$$q = \frac{6\sqrt{3}FQ}{\pi\sqrt{\pi abc}} e^{\left(\frac{-3x^2}{a^2}\right)} e^{\left(\frac{-3y^2}{b^2}\right)} e^{\left(\frac{-3z^2}{c^2}\right)}$$

where:

$q$  = weld source power density

$(x, y, z)$  = coordinates of point  $p$  in weld material

$$F = \begin{cases} F_f & \text{if point } p \text{ is in front of beam} \\ F_r & \text{if point } p \text{ is behind beam} \end{cases}$$

$$c = \begin{cases} c_f & \text{if point } p \text{ is in front of beam} \\ c_r & \text{if point } p \text{ is behind beam} \end{cases}$$

A local coordinate system is constructed which is centered at the heat source. The relative velocity vector of the heat source defines the "forward" direction, so material points that are approaching the heat source are in "front" of the beam. The beam aiming direction is used to compute the weld pool depth. The weld pool width is measured normal to the relative velocity - aiming direction plane.



**\*BOUNDARY\_USA\_SURFACE**

Purpose: Define a surface for coupling with the USA boundary element code [DeRuntz 1993]. The outward normal vectors should point into the fluid media.

Card            1            2            3            4            5            6            7            8

Variable	SSID	WETDRY	NBEAM					
Type	I	I	I					
Default	none	0	0					

<u>VARIABLE</u>	<u>DESCRIPTION</u>
SSID	Segment set ID, see *SET_SEGMENT
WETDRY	Wet surface flag: EQ.0: Dry, no coupling, EQ.1: Wet, coupled with USA.
NBEAM	The number of nodes touched by USA Surface-of-Revolution (SOR) elements. It is not necessary that the LS-DYNA model has beams where USA has beams (i.e., SOR elements), merely that the LS-DYNA model has nodes to receive the forces that USA will return.

**Remarks:**

The wet surface of 3 and 4-noded USA General boundary elements is defined in LS-DYNA with a segment set of 4-noded surface segments, where the fourth node can duplicate the third node to form a triangle. The segment normals should be directed into the USA fluid. If USA overlays are going to be used to reduce the size of the DAA matrices, the user should nonetheless define the wet surface here as if no overlay were being used. If Surface-of -Revolution elements (SORs) are being used in USA, then NBEAM should be non-zero on one and only one card in this section.

When running a coupled problem with USA, the procedure involves several steps. First, LS-DYNA is executed to create a LS-DYNA dump file "d3dump" and a linking file "strnam" which contains the nodal grid point data and wet segment connectivity data for the FLUMAS processor, and the dof-equation table and structural mass vector for the AUGMAT processor. "Dyna.pre" is

denoted "grdnam" in the FLUMAS manual and "strnam" in the AUGMAT manual. The execution line in the first step is:

**LS-DYNA** memory=nwds i=inputfilename > outputfilename

where "inputfilename" is the LS-DYNA input file.

In the second step, the DAA fluid mass matrix is created through execution of the USA FLUMAS processor:

**FLUMAS** -m nwds < flumasinputfilename > flumasoutputfilename

In the third step, the modified augmented DAA equations for the coupled problem are calculated and saved through execution of the USA AUGMAT processor:

**AUGMAT** -m nwds < augmatinputfilename > augmatoutputfilename

This step is repeated whenever one wishes to change DAA formulations.

In the fourth step the actual coupled time-integration is conducted using the execution line:

**LS-DYNA** memory=nwds r=d3dump usa=usainputfilename > outputfilename

The input files, flumasinputfilename, augmatinputfilename, and usainputfilename, are prepared in accordance with the USA code documentation.

It is advisable when running coupled problems to check the ASCII output files to ensure that each run completed normally.

**\*BOUNDARY\_ELEMENT\_METHOD\_OPTION**

Available options include:

**CONTROL**

**FLOW**

**NEIGHBOR**

**SYMMETRY**

**WAKE**

Purpose: Define input parameters for boundary element method analysis of incompressible fluid dynamics or fluid-structure interaction problems.

The boundary element method (BEM) can be used to compute the steady state or transient fluid flow about a rigid or deformable body. The theory which underlies the method (see the LS-DYNA Theory Manual) is restricted to inviscid, incompressible, attached fluid flow. The method should not be used to analyze flows where shocks or cavitation are present.

In practice the method can be successfully applied to a wider class of fluid flow problems than the assumption of inviscid, incompressible, attached flow would imply. Many flows of practical engineering significance have large Reynolds numbers (above 1 million). For these flows the effects of fluid viscosity are small if the flow remains attached, and the assumption of zero viscosity may not be a significant limitation. Flow separation does not necessarily invalidate the analysis. If well-defined separation lines exist on the body, then wakes can be attached to these separation lines and reasonable results can be obtained. The Prandtl-Glauert rule can be used to correct for non-zero Mach numbers in a gas, so the effects of aerodynamic compressibility can be correctly modeled (as long as no shocks are present).

The `BOUNDARY_ELEMENT_METHOD_FLOW` card turns on the analysis, and is mandatory.

**\*BOUNDARY\_ELEMENT\_METHOD\_CONTROL**

Purpose: Control the execution time of the boundary element method calculation. The **CONTROL** option is used to control the execution time of the boundary element method calculation, and the use of this option is strongly recommended. The BEM calculations can easily dominate the total execution time of a LS-DYNA run unless the parameters on this card (especially DTBEM and/or IUPBEM) are used appropriately.

DTBEM is used to increase the time increment between calls to the BEM routines. This can usually be done with little loss in accuracy since the characteristic times of the structural dynamics and the fluid flow can differ by several orders of magnitude. The characteristic time of the structural dynamics in LS-DYNA is given by the size of the smallest structural element divided by the speed of sound of its material. For a typical problem this characteristic time might be equal to 1 microsecond. Since the fluid in the boundary element method is assumed to be incompressible (infinite speed of sound), the characteristic time of the fluid flow is given by the streamwise length of the smallest surface in the flow divided by the fluid velocity. For a typical problem this characteristic time might be equal to 10 milliseconds. For this example DTBEM might be set to 1 millisecond with little loss of accuracy. Thus, for this example, the boundary element method would be called only once for every 1000 LS-DYNA iterations, saving an enormous amount of computer time.

IUPBEM is used to increase the number of times the BEM routines are called before the matrix of influence coefficients is recomputed and factored (these are time-consuming procedures). If the motion of the body is entirely rigid body motion there is no need to ever recompute and factor the matrix of influence coefficients after initialization, and the execution time of the BEM can be significantly reduced by setting IUPBEM to a very large number. For situations where the structural deformations are modest an intermediate value (e.g., 10) for IUPBEM can be used.

Card            1            2            3            4            5            6            7            8

Variable	LWAKE	DTBEM	IUPBEM	FARBEM				
Type	I	F	I	F				
Default	50	0.	100	2.0				
Remark	1			2				

**VARIABLE****DESCRIPTION**

LWAKE

Number of elements in the wake of lifting surfaces. Wakes must be defined for all lifting surfaces.

---

<b><u>VARIABLE</u></b>	<b><u>DESCRIPTION</u></b>
DTBEM	Time increment between calls to the boundary element method. The fluid pressures computed during the previous call to the BEM will continue to be used for subsequent LS-DYNA iterations until a time increment of DTBEM has elapsed.
IUPBEM	The number of times the BEM routines are called before the matrix of influence coefficients is recomputed and refactored.
FARBEM	Nondimensional boundary between near-field and far-field calculation of influence coefficients.

**Remarks:**

1. Wakes convect with the free-stream velocity. The number of elements in the wake should be set to provide a total wake length equal to 5-10 times the characteristic streamwise length of the lifting surface to which the wake is attached. Note that each wake element has a streamwise length equal to the magnitude of the free stream velocity multiplied by the time increment between calls to the boundary element method routines. This time increment is controlled by DTBEM.
2. The most accurate results will be obtained with FARBEM set to 5 or more, while values as low as 2 will provide slightly reduced accuracy with a 50% reduction in the time required to compute the matrix of influence coefficients.

# \*BOUNDARY

# \*BOUNDARY\_ELEMENT\_METHOD\_FLOW

## \*BOUNDARY\_ELEMENT\_METHOD\_FLOW

Purpose: Turn on the boundary element method calculation, specify the set of shells which define the surface of the bodies of interest, and specify the onset flow.

The \*BOUNDARY\_ELEMENT\_METHOD\_FLOW card turns on the BEM calculation. This card also identifies the shell elements which define the surfaces of the bodies of interest, and the properties of the onset fluid flow. The onset flow can be zero for bodies which move through a fluid which is initially at rest.

Card                    1                    2                    3                    4                    5                    6                    7                    8

Variable	SSID	VX	VY	VZ	RO	PSTATIC	MACH	
Type	I	F	F	F	F	F	F	
Default	none	none	none	none	none	0.	0.	
Remark	1					2	3	

### VARIABLE

### DESCRIPTION

SSID	Shell set ID for the set of shell elements which define the surface of the bodies of interest (see *SET_SHELL). The nodes of these shells should be ordered so that the shell normals point into the fluid.
VX, VY, VZ	x, y, and z components of the free-stream fluid velocity.
RO	Fluid density.
PSTATIC	Fluid static pressure.
MACH	Free-stream Mach number.

### Remarks:

1. It is recommended that the shell segments in the SSID set use the NULL material (see \*MAT\_NULL). This will provide for the display of fluid pressures in the post-processor. For triangular shells the 4th node number should be the same as the 3rd node number. For fluid-structure interaction problems it is recommended that the boundary element shells use the same nodes and be coincident with the structural shell elements (or the outer face

of solid elements) which define the surface of the body. This approach guarantees that the boundary element segments will move with the surface of the body as it deforms.

2. A pressure of `PSTATIC` is applied uniformly to all segments in the segment set. If the body of interest is hollow, then `PSTATIC` should be set to the free-stream static pressure minus the pressure on the inside of the body.
3. The effects of subsonic compressibility on gas flows can be included using a non-zero value for `MACH`. The pressures which arise from the fluid flow are increased using the Prandtl-Glauert compressibility correction. `MACH` should be set to zero for water or other liquid flows.

**\*BOUNDARY\_ELEMENT\_METHOD\_NEIGHBOR**

Purpose: Define the neighboring elements for a given boundary element segment.

The pressure at the surface of a body is determined by the gradient of the doublet distribution on the surface (see the LS-DYNA Theory Manual). The “Neighbor Array” is used to specify how the gradient is computed for each boundary element segment. Ordinarily, the Neighbor Array is set up automatically by LS-DYNA, and no user input is required. The NEIGHBOR option is provided for those circumstances when the user desires to define this array manually.

For the **NEIGHBOR** option define the following cards:

**Cards 1, 2, 3, ... (The next “\*” card terminates the input.)**

Card            1            2            3            4            5            6            7            8

Variable	NELEM	NABOR1	NABOR2	NABOR3	NABOR4			
Type	I	I	I	I	I			
Default	none	none	none	none	none			

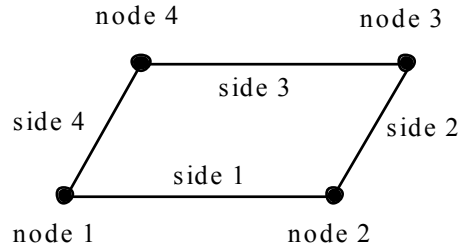
**VARIABLE****DESCRIPTION**

NELEM	Element number.
NABOR1	Neighbor for side 1 of NELEM.
NABOR2	Neighbor for side 2 of NELEM.
NABOR3	Neighbor for side 3 of NELEM.
NABOR4	Neighbor for side 4 of NELEM.

**Remarks:**

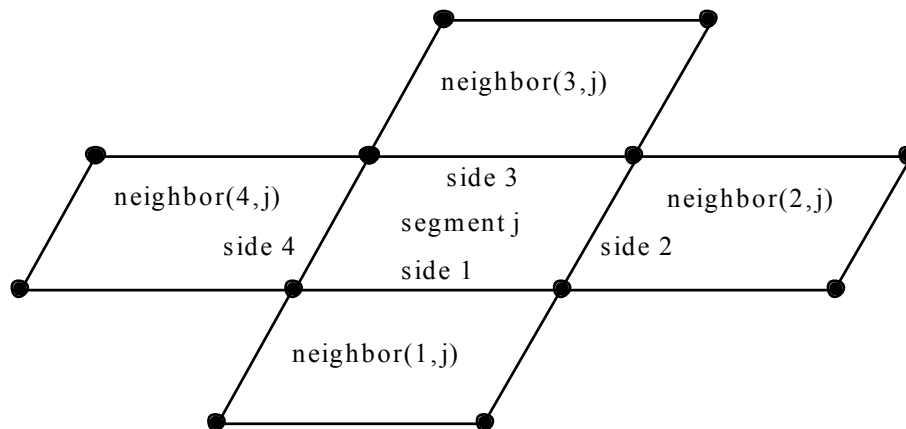
Each boundary element has 4 sides (Figure 6.1). Side 1 connects the 1st and 2nd nodes, side 2 connects the 2nd and 3rd nodes, etc. The 4th side is null for triangular elements.





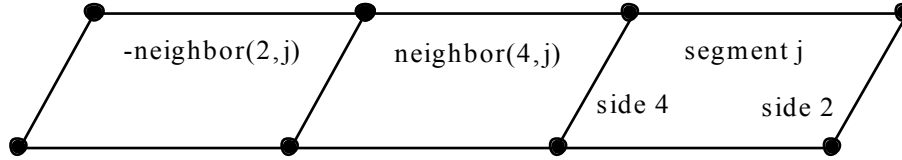
**Figure 6.1** Each segment has 4 sides.

For most elements the specification of neighbors is straightforward. For the typical case a quadrilateral element is surrounded by 4 other elements, and the neighbor array is as shown in Figure 6.2.



**Figure 6.2** Typical neighbor specification.

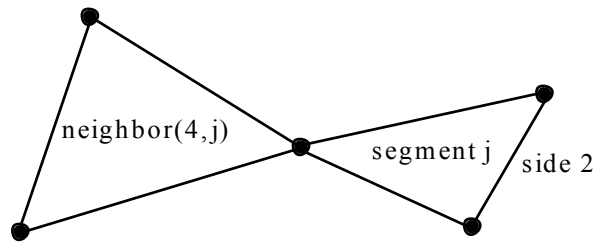
There are several situations for which the user may desire to directly specify the neighbor array for certain elements. For example, boundary element wakes result in discontinuous doublet distributions, and neighbors which cross a wake should not be used. Figure 6.3 illustrates a situation where a wake is attached to side 2 of segment  $j$ . For this situation two options exist. If  $\text{neighbor}(2,j)$  is set to zero, then a linear computation of the gradient in the side 2 to side 4 direction will be made using the difference between the doublet strengths on segment  $j$  and segment  $\text{neighbor}(4,j)$ . This is the default setup used by LS-DYNA when no user input is provided. By specifying  $\text{neighbor}(2,j)$  as a negative number a more accurate quadratic curve fit will be used to compute the gradient. The curve fit will use segment  $j$ , segment  $\text{neighbor}(4,j)$ , and segment  $-\text{neighbor}(2,j)$ ; which is located on the opposite side of segment  $\text{neighbor}(4,j)$  as segment  $j$ .



**Figure 6.3** If neighbor(2,j) is a negative number it is assumed to lie on the opposite side of neighbor(4,j) as segment j.

Another possibility is that no neighbors at all are available in the side 2 to side 4 direction. In this case both neighbor(2,j) and neighbor(4,j) can be set to zero, and the gradient in that direction will be assumed to be zero. This option should be used with caution, as the resulting fluid pressures will not be accurate for three-dimensional flows. However, this option is occasionally useful where quasi-two dimensional results are desired. All of the above options apply to the side 1 to side 3 direction in the obvious ways.

For triangular boundary elements side 4 is null. Gradients in the side 2 to side 4 direction can be computed as described above by setting neighbor(4,j) to zero for a linear derivative computation (this is the default setup used by LS-DYNA when no user input is provided) or to a negative number to use the segment on the other side of neighbor(2,j) and a quadratic curve fit. There may also be another triangular segment which can be used as neighbor(4,j) (see Figure 6.4).



**Figure 6.4** Sometimes another triangular boundary element segment can be used as neighbor (4,j).

The rules for computing the doublet gradient in the side 2 to side 4 direction can be summarized as follows (the side 1 to side 3 case is similar):

NABOR2	NABOR4	Doublet Gradient Computation
GT.0	GT.0	quadratic fit using elements j, NABOR2, and NABOR4
LT.0	GT.0	quadratic fit using elements j, -NABOR2, and NABOR4. -NABOR2 is assumed to lie on the opposite side of NABOR4 as segment j (see Fig. 6.3)
GT.0	LT.0	quadratic fit using elements j, NABOR2, and -NABOR4. -NABOR4 is assumed to lie on the opposite side of NABOR2 as segment j
EQ.0	GT.0	linear fit using elements j and NABOR4
GT.0	EQ.0	linear fit using elements j and NABOR2
EQ.0	EQ.0	zero gradient

**Table 6.1** Surface pressure computation for element j.

# \*BOUNDARY

# \*BOUNDARY\_ELEMENT\_METHOD\_SYMMETRY

## \*BOUNDARY\_ELEMENT\_METHOD\_SYMMETRY

Purpose: To define a plane of symmetry for the boundary element method. The SYMMETRY option can be used to reduce the time and memory required for symmetric configurations. For these configurations the reduction in the number of boundary elements by a factor of 2 will reduce the memory used by the boundary element method by a factor of 4, and will reduce the computer time required to factor the matrix of influence coefficients by a factor of 8. Only 1 plane of symmetry can be defined.

For the SYMMETRY option define the following card:

Card            1            2            3            4            5            6            7            8

Variable	BMSYM							
Type	I							
Default	0							
Remark								

### VARIABLE

### DESCRIPTION

BMSYM

Defines symmetry plane for boundary element method.

EQ.0: no symmetry plane is defined

EQ.1:  $x = 0$  is a symmetry plane

EQ.2:  $y = 0$  is a symmetry plane

EQ.3:  $z = 0$  is a symmetry plane

**\*BOUNDARY\_ELEMENT\_METHOD\_WAKE**

Purpose: To attach wakes to the trailing edges of lifting surfaces. Wakes should be attached to boundary elements at the trailing edge of a lifting surface (such as a wing, propeller blade, rudder, or diving plane). Wakes should also be attached to known separation lines when detached flow is known to exist (such as the sharp leading edge of a delta wing at high angles of attack). Wakes are required for the correct computation of surface pressures for these situations. As described above, two segments on opposite sides of a wake should never be used as neighbors.

For the **WAKE** option define the following cards:

**Cards 1, 2, 3, ... (The next "\*" card terminates the input.)**

Card            1            2            3            4            5            6            7            8

Variable	NELEM	NSIDE						
Type	I	I						
Default	none	none						
Remark	1							

<u>VARIABLE</u>	<u>DESCRIPTION</u>
NELEM	Element number to which a wake is attached.
NSIDE	The side of NELEM to which the wake is attached (see Fig. 6.1). This should be the "downstream" side of NELEM.

**Remarks:**

1. Normally two elements meet at a trailing edge (one on the "upper" surface and one on the "lower" surface). The wake can be attached to either element, but not to both.



# **\*CASE**

The **\*CASE** command provides a way of running multiple LS-DYNA analyses (or cases) sequentially by submitting a single input file. When **\*CASE** commands are used to define multiple cases, some portions of the input will be shared by some or all of the cases and other portions will be unique to each case. Because the cases are run sequentially, the results from one case, e.g., a dynain file, can be used in the analysis of a different, subsequent case. Each case creates a unique set of output file names by prepending “casen.” to the default file name, e.g., case101.d3plot, case102.glstat.

When the **\*CASE** keyword appears in an input deck, it becomes necessary to append the word “CASE” to the LS-DYNA execution line. For example, an SMP LS-DYNA execution line might look something like

```
path_to_ls-dyna i=input.k ncpu=-4 CASE
```

An MPP LS-DYNA execution line might look something like

```
mpirun -np 4 path_to_mpp971 i=input.k CASE
```

## **\*CASE\_{OPTION}**

Available options include:

**<BLANK>**

**BEGIN\_n**

**END\_n**

Purpose: Define a series of cases and perhaps subcases. The options **\*CASE\_BEGIN\_n** and **\*CASE\_END\_n** appear in pairs and **n** is a numeric ID of a subcase. Subcase IDs may be referenced by the **\*CASE** command in defining a case. In other words, a case may consist of one or more subcases. All keywords appearing between **\*CASE\_BEGIN\_n** and **\*CASE\_END\_n** comprise subcase **n**. If no **\*CASE** command is defined, then subcases defined by **\*CASE\_BEGIN\_n** and **\*CASE\_END\_n** then become cases. **\*CASE\_BEGIN/\*CASE\_END** can be nested, overlapped, and disjointed. Examples below demonstrate the use of these options.

An alternative way of defining subcases is by appending the string “CID=n” to the end of any keyword command. Any keyword so tagged will then be active only for those cases that reference subcase **n**. There can be more than one space between the keyword and “CID=n”.

Any keyword in the input deck not associated with a subcase is active for all cases.

The following input syntax applies only to the **\*CASE** command, not to **\*CASE\_BEGIN/\*CASE\_END**.

# \*CASE

---

Card 1            1            2            3            4            5            6            7            8

Variable	CASEID							
Type	I							
Default	None							

**Optional: Define if additional command line arguments are required for this case ID.**

Cards 2, ...    1            2            3            4            5            6            7            8

Variable	COMMANDS							
Type	A							
Default	Not Required							

**Define active subcase IDs for this case. Use as many cards as necessary.**

Cards ...        1            2            3            4            5            6            7            8

Variable	SCID1	SCID2	...	...	...	...	SCID7	...
Type	I	I	I	I	I	I	I	I
Default	none	none	none	none	none	none	none	None

**VARIABLE**

**DESCRIPTION**

CASEID            Identification number for case.

COMMANDS        Command line arguments.

SCIDn             Subcase ID active for case CASEID.





## **\*CASE**

---

### Remarks:

1. If no \*CASE keyword appears, subcases defined with \*CASE\_BEGIN/\*CASE\_END commands become cases and \*CASE\_BEGIN can optionally be followed by extra command line arguments.
2. If no \*CASE keyword appears, it is an error to append “CID=n” to any keyword.
3. If multiple \*CASE or \*CASE\_BEGIN keywords appear that have the same ID, their command line arguments and active commands are merged.

**\*COMMENT**

Purpose: Define comments.

Card 1            1            2            3            4            5            6            7            8

Variable	COMMENT							
Type	A							
Default	none							

<u>VARIABLE</u>	<u>DESCRIPTION</u>
COMMENT	Any comment line.

**Remarks:**

1. Any number of comment lines may be used. All comment lines will be echoed to the screen and to the message and d3hsp files.



# **\*COMPONENT**

The keyword **\*COMPONENT** provides a way of incorporating specialized components and features. The keyword control cards in this section are defined in alphabetical order:

**\*COMPONENT\_GEBOD\_OPTION**

**\*COMPONENT\_GEBOD\_JOINT\_OPTION**

**\*COMPONENT\_HYBRIDIII**

**\*COMPONENT\_HYBRIDIII\_JOINT\_OPTION**

**\*COMPONENT\_GEBOD\_OPTION**

Purpose: Generate a rigid body dummy based on dimensions and mass properties from the GEBOD database. The motion of the dummy is governed by equations integrated within LS-DYNA separately from the finite element model. Default joint characteristics (stiffness's, stop angles, etc.) are set internally and should give reasonable results, however, they may be altered using the \*COMPONENT\_GEBOD\_JOINT command. Contact between the segments of the dummy and the finite element model is defined using the \*CONTACT\_GEBOD command. The use of a positioning file is essential with this feature, see Appendix N for further details.

OPTION specifies the human subject type. The male and female types represent adults while the child is genderless.

**MALE****FEMALE****CHILD**

Card 1            1            2            3            4            5            6            7            8

Variable	DID	UNITS	SIZE					
Type	I	I	F					
Default	none	none	none					

Card 2            1            2            3            4            5            6            7            8

Variable	VX	VY	VZ	GX	GY	GZ		
Type	F	F	F	F	F	F		
Default	0.	0.	0.	0.	0.	0.		

**VARIABLE****DESCRIPTION**

DID

Dummy ID. A unique number must be specified.



**\*COMPONENT\_GEBOD\_JOINT\_OPTION**

Purpose: Alter the joint characteristics of a GEBOD rigid body dummy. Setting a joint parameter value to zero retains the default value set internally. See Appendix N for further details.

The following options are available.

**PELVIS****WAIST****LOWER\_NECK****UPPER\_NECK****LEFT\_SHOULDER****RIGHT\_SHOULDER****LEFT\_ELBOW****RIGHT\_ELBOW****LEFT\_HIP****RIGHT\_HIP****LEFT\_KNEE****RIGHT\_KNEE****LEFT\_ANKLE****RIGHT\_ANKLE**

Card 1            1            2            3            4            5            6            7            8

Variable	DID	LC1	LC2	LC3	SCF1	SCF2	SCF3	
Type	F	I	I	I	F	F	F	



<u>VARIABLE</u>	<u>DESCRIPTION</u>
DID	Dummy ID, see *COMPONENT_GEBOD_OPTION.
LCi	Load curve ID specifying the loading torque versus rotation (in radians) for the i-th degree of freedom of the joint.
SCFi	Scale factor applied to the load curve of the i-th joint degree of freedom.

Card 2            1            2            3            4            5            6            7            8

Variable	C1	C2	C3	NEUT1	NEUT2	NEUT3		
Type	F	F	F	F	F	F		

<u>VARIABLE</u>	<u>DESCRIPTION</u>
Ci	Linear viscous damping coefficient applied to the i-th DOF of the joint. Units are torque*time/radian, where the units of torque and time depend on the choice of UNITS in card 1 of *COMPONENT_GEBOD_OPTION.
NEUTi	Neutral angle (degrees) of joint's i-th DOF.

Card 3            1            2            3            4            5            6            7            8

Variable	LOSA1	HISA1	LOSA2	HISA2	LOSA3	HISA3		
Type	F	F	F	F	F	F		

<u>VARIABLE</u>	<u>DESCRIPTION</u>
LOSAi	Value of the low stop angle (degrees) for the i-th DOF of this joint.
HISAi	Value of the high stop angle (degrees) for the i-th DOF of this joint.





**\*COMPONENT\_HYBRIDIII**

Purpose: Define a HYBRID III dummy. The motion of the dummy is governed by equations integrated within LS-DYNA separately from the finite element model. The dummy interacts with the finite element structure through contact interfaces. Joint characteristics (stiffnesses, damping, friction, etc.) are set internally and should give reasonable results, however, they may be altered using the \*COMPONENT\_HYBRIDIII\_JOINT command. Joint force and moments can be written to an ASCII file (see \*DATABASE\_H3OUT).

Card 1            1            2            3            4            5            6            7            8

Variable	DID	SIZE	UNITS	DEFRM	VX	VY	VZ	
Type	I	I	I	I	F	F	F	
Default	none	none	none	1	0.	0.	0.	

**VARIABLE****DESCRIPTION**

DID	Dummy ID. A unique number must be specified.
SIZE	Size of dummy. EQ.1: 5th percentile adult EQ.2: 50th percentile adult EQ.3: 95th percentile adult Note: If negative then the best of currently available joint properties are applied.
UNITS	System of units used in the finite element model. EQ.1: lbf*sec <sup>2</sup> /in - inch - sec EQ.2: kg - meter - sec EQ.3: kgf*sec <sup>2</sup> /mm - mm - sec EQ.4: metric ton - mm - sec EQ.5: kg - mm - msec
DEFRM	Deformability type. EQ.1: all dummy segments entirely rigid EQ.2: deformable abdomen (low density foam, mat #57) EQ.3: deformable jacket (low density foam, mat #57) EQ.4: deformable headskin (viscoelastic, mat #6) EQ.5: deformable abdomen/jacket EQ.6: deformable jacket/headskin EQ.7: deformable abdomen/headskin



# \*COMPONENT

# \*COMPONENT\_HYBRIDIII\_JOINT

## \*COMPONENT\_HYBRIDIII\_JOINT\_OPTION

Purpose: Alter the joint characteristics of a HYBRID III dummy. Setting a joint parameter value to zero retains the default value set internally. Joint force and moments can be written to an ASCII file (see \*DATABASE\_H3OUT). Further details pertaining to the joints are found in the Hybrid III Dummies section of Appendix N.

The following options are available:

<b>LUMBAR</b>	<b>RIGHT_ELBOW</b>	<b>RIGHT_KNEE</b>
<b>LOWER_NECK</b>	<b>LEFT_WRIST</b>	<b>LEFT_ANKLE</b>
<b>UPPER_NECK</b>	<b>RIGHT_WRIST</b>	<b>RIGHT_ANKLE</b>
<b>LEFT_SHOULDER</b>	<b>LEFT_HIP</b>	<b>STERNUM</b>
<b>RIGHT_SHOULDER</b>	<b>RIGHT_HIP</b>	<b>LEFT_KNEE_SLIDER</b>
<b>LEFT_ELBOW</b>	<b>LEFT_KNEE</b>	<b>RIGHT_KNEE_SLIDER</b>

Card 1            1            2            3            4            5            6            7            8

Variable	DID	Q1	Q2	Q3	FRIC			
Type	F	F	F	F	F			

Card 2            1            2            3            4            5            6            7            8

Variable	C1	ALO1	BLO1	AHI1	BHI1	QLO1	QHI1	SCLK1
Type	F	F	F	F	F	F	F	F

**Card 3 - Left blank if joint has only one degree of freedom.**

Card 3            1            2            3            4            5            6            7            8

Variable	C2	ALO2	BLO2	AHI2	BHI2	QLO2	QHI2	SCLK2
Type	F	F	F	F	F	F	F	F

**Card 4 - Left blank if the joint has only two degrees of freedom.**

Card 4            1            2            3            4            5            6            7            8

Variable	C3	ALO3	BLO3	AHI3	BHI3	QLO3	QHI3	SCLK3
Type	F	F	F	F	F	F	F	F

**VARIABLE****DESCRIPTION**

DID	Dummy ID, see *COMPONENT_HYBRIDIII
Qi	Initial value of the joint's i-th degree of freedom. Units of degrees are defined for rotational DOF. See Appendix N for a listing of the applicable DOF.
FRIC	Friction load on the joint.
Ci	Linear viscous damping coefficient applied to the i-th DOF of the joint.
ALOi	Linear coefficient for the low regime spring of the joint's i-th DOF.
BLOi	Cubic coefficient for the low regime spring of the joint's i-th DOF.
AHi	Linear coefficient for the high regime spring of the joint's i-th DOF.
BHi	Cubic coefficient for the high regime spring of the joint's i-th DOF.
QLOi	Value at which the low regime spring definition becomes active.
QHi	Value at which the high regime spring definition becomes active.
SCLKi	Scale value applied to the stiffness of the joint's i-th DOF (default=1.0).





# **\*CONSTRAINED**

The keyword \*CONSTRAINED provides a way of constraining degrees of freedom to move together in some way. The keyword cards in this section are defined in alphabetical order:

- \*CONSTRAINED\_ADAPTIVITY**
- \*CONSTRAINED\_BUTT\_WELD**
- \*CONSTRAINED\_EULER\_IN\_EULER**
- \*CONSTRAINED\_EXTRA\_NODES\_OPTION**
- \*CONSTRAINED\_GENERALIZED\_WELD\_OPTION\_{OPTION}**
- \*CONSTRAINED\_GLOBAL**
- \*CONSTRAINED\_INTERPOLATION\_{OPTION}**
- \*CONSTRAINED\_JOINT\_OPTION\_{OPTION}\_{OPTION}\_{OPTION}**
- \*CONSTRAINED\_JOINT\_COOR\_OPTION\_{OPTION}\_{OPTION}\_{OPTION}**
- \*CONSTRAINED\_JOINT\_STIFFNESS\_OPTION**
- \*CONSTRAINED\_LAGRANGE\_IN\_SOLID**
- \*CONSTRAINED\_LINEAR\_GLOBAL**
- \*CONSTRAINED\_LINEAR\_LOCAL**
- \*CONSTRAINED\_LOCAL**
- \*CONSTRAINED\_NODAL\_RIGID\_BODY\_{OPTION}\_{OPTION}**
- \*CONSTRAINED\_NODE\_INTERPOLATION**
- \*CONSTRAINED\_NODE\_SET\_{OPTION}**
- \*CONSTRAINED\_POINTS**
- \*CONSTRAINED\_RIGID\_BODIES**
- \*CONSTRAINED\_RIGID\_BODY\_STOPPERS**
- \*CONSTRAINED\_RIVET\_{OPTION}**
- \*CONSTRAINED\_SHELL\_TO\_SOLID**
- \*CONSTRAINED\_SPLINE**
- \*CONSTRAINED\_SPOTWELD\_{OPTION}\_{OPTION}**
- \*CONSTRAINED\_SPR2**
- \*CONSTRAINED\_TIE-BREAK**
- \*CONSTRAINED\_TIED\_NODES\_FAILURE**

**\*CONSTRAINED\_ADAPTIVITY**

Purpose: Define an adaptive constraint which constrains a node to the midpoint along an edge of a shell element. This keyword is also created by LS-DYNA during an adaptive calculation. This option applies to shell elements.

Card            1            2            3            4            5            6            7            8

Variable	SN	MN1	MN2					
Type	I	I	I					
Default	none	none	none					

**VARIABLE****DESCRIPTION**

SN	Slave node. This is the node constrained at the midpoint of an edge of a shell element.
MN1	One node along the edge of the shell element.
MN2	The second node along the edge.

**\*CONSTRAINED\_BUTT\_WELD**

Purpose: Define a line of coincident nodes that represent a structural butt weld between two parts defined by shell elements. Failure is based on nodal plastic strain for ductile failure and stress resultants for brittle failure. This input is much simpler than the alternative approach for defining butt welds, see \*CONSTRAINED\_GENERALIZED\_WELD\_BUTT. The local coordinate system, the effective length, and thickness for each pair of butt welded nodes are determined automatically in the definition below. In the GENERALIZED option these quantities must be defined in the input.

Card            1            2            3            4            5            6            7            8

Variable	SNSID	MNSID	EPPF	SIGF	BETA			
Type	I	I	F	F	F			
Default	none	none	0.	1.e+16	1.0			
Remarks		1, 2	3, 4	3	3			

<u>VARIABLE</u>	<u>DESCRIPTION</u>
SNSID	Slave node set ID, see *SET_NODE_OPTION.
MNSID	Master node set ID, see *SET_NODE_OPTION.
EPPF	Plastic strain at failure
SIGF	$\sigma_f$ , stress at failure for brittle failure.
BETA	$\beta$ , failure parameter for brittle failure.

**Remarks:**

- Nodes in the master and slave sets must be given in the order they appear as one moves along the edge of the surface. An equal number of coincident nodes must be defined in each set. In a line weld the first and last node in a string of nodes can be repeated in the two sets. If the first and last pair of nodal points are identical, a circular or closed loop butt weld is assumed. See Figure 9.1, where the line butt weld and closed loop weld are illustrated.

2. Butt welds may not cross. For complicated welds, this option can be combined with the input in \*CONSTRAINED\_GENERALIZED\_WELD\_BUTT to handle the case where crossing occurs. Nodes in a butt weld must not be members of rigid bodies.
3. If the average volume-weighted effective plastic strain in the shell elements adjacent to a node exceeds the specified plastic strain at failure, the node is released. Brittle failure of the butt welds occurs when:

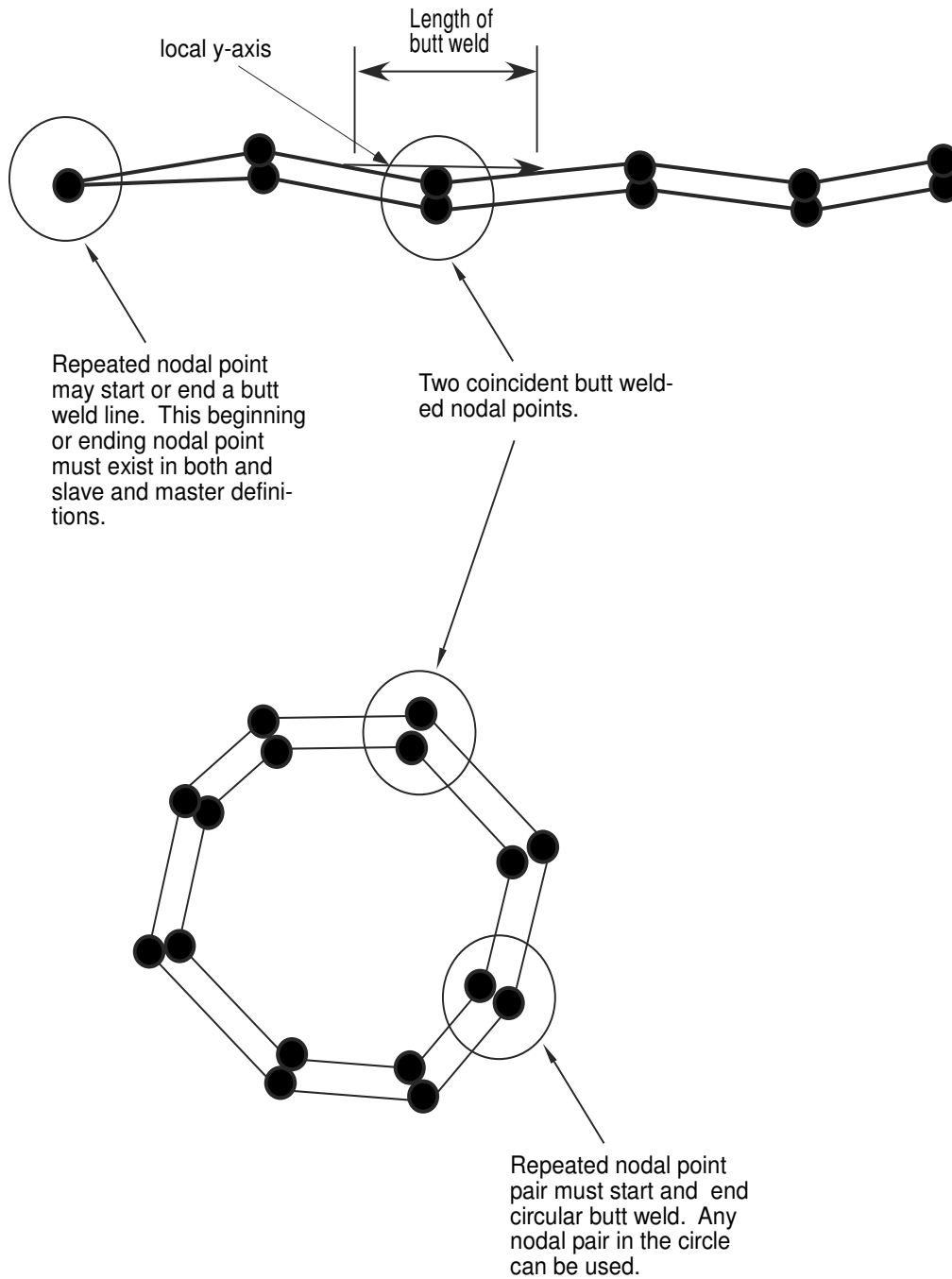
$$\beta \sqrt{\sigma_n^2 + 3(\tau_n^2 + \tau_t^2)} \geq \sigma_f$$

where

- $\sigma_n$  = normal stress (local x)
- $\tau_n$  = shear stress in direction of weld (local y)
- $\tau_t$  = shear stress normal to weld (local z)
- $\sigma_f$  = failure stress
- $\beta$  = failure parameter

Component  $\sigma_n$  is nonzero for tensile values only. The nodes defining the slave and master sides of the butt weld must coincide. The local z-axis at a master node is normal to the master side plane of the butt weld at the node, and the local y-axis is taken as the vector in the direction of a line connecting the mid-points of the line segments lying on either side of the master node. The normal vector is found by summing the unit normal vectors of all shell elements on the master side sharing the butt welded node. The direction of the normal vector at the node is chosen so that the x-local vector points towards the elements on the slave side in order to identify tensile versus compressive stresses. The thickness of the butt weld and length of the butt weld are needed to compute the stress values. The thickness is based on the average thickness of the shell elements that share the butt welded nodal pair, and the chosen length of the butt weld is shown in Figure 9.1.

4. Butt welds may be used to simulate the effect of failure along a predetermined line, such as a seam or structural joint. When the failure criterion is reached at a nodal pair, the nodes begin to separate. As this effect propagates, the weld will appear to “unzip,” thus simulating failure of the connection.



**Figure 9.1.** Definition of butt welds are shown above. The butt weld can be represented by a line of nodal points or by a closed loop.

**\*CONSTRAINED\_COORDINATE\_{OPTION}**

To define constraints based on position coordinates the following options are available:

<BLANK>

**LOCAL**

Purpose: The keyword is developed to allow the definition of constraints in position coordinates in springback simulation. With the frequent application of adaptive mesh in stamping simulation, nodes needed for springback constraints are often unavailable until the last process simulation before springback is complete. On the other hand, if the nodes are available, their positions may not be exactly on the desired locations required for springback constraints. With this new keyword, the springback simulation is no longer dependent on the previous process simulation results and the exact springback constraint locations can be specified.

Card 1            1            2            3            4            5            6            7            8

Variable	ID	PID	IDIR	X1	Y1	Z1	CID	
Type	I	I	I	F	F	F	I	
Default	none	none	none	0.0	0.0	0.0	0	

**VARIABLE****DESCRIPTION**

ID	Identification number of a constraint.
PID	Part ID of the part to be constrained.
IDIR	Applicable degrees-of-freedom being constrained: EQ. 1: x translational degree-of-freedom, EQ. 2: y translational degree-of-freedom, EQ. 3: z translational degree-of-freedom.
X1, Y1, Z1	X, Y, Z coordinates of the location being constrained.
CID	Local coordinate system ID.

**Remarks:**

1. Identification number of a constraint must be unique.

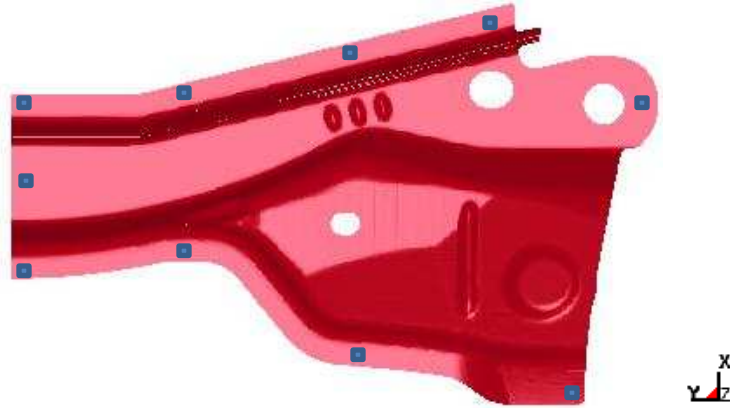
2. Part ID of the part to be constrained must be input correctly.
3. When the option `_LOCAL` is invoked, local coordinate system ID (CID) should be input and defined using keyword `*DEFINE_COORDINATE_{OPTION}`. A local coordinate system can be created easily with `Coord` menu in page 5 of the LSPP v2.4. Under `Coord` menu, select `SYSTEM` under `Create`, and use `EPoint` and `alongZ` to define the system based on one straight line. For LSPP v3.1, in menu 'Model and Part' and under 'Create Entity', select 'Define / Coordinate', and check 'Cre' for create. Select \*System in the pulldown menu next to 'Type', check 'Geopts' to define a local system based on two geometry points, pick two points and select the desired axis in the pulldown menu next to 'Direction', and hit 'Apply'.
4. An example of using the keyword is listed below. A part with PID 18 is constrained in 6 locations in local coordinate system ID 9, defined by keyword `*DEFINE_COORDINATE_SYSTEM`. Constrained DOFs are indicated by `IDIR`.

```

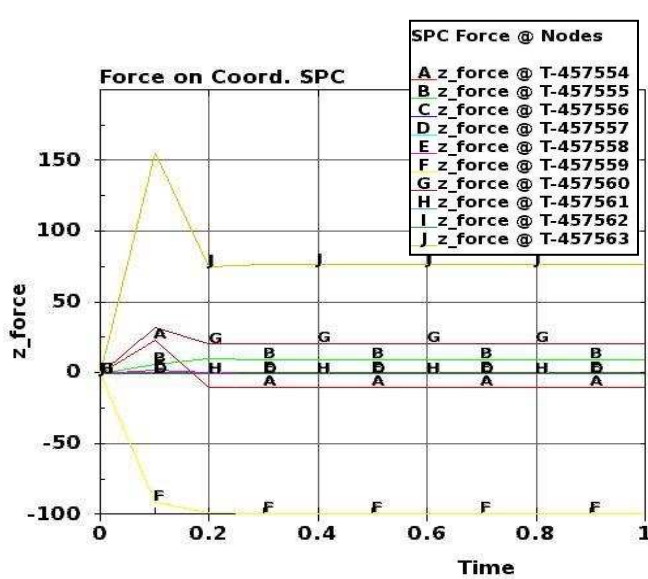
$---+---1---+---2---+---3---+---4---+---5---+---6---+---7---+---8
*CONSTRAINED_COORDINATE
$      ID      IDPT      IDIR      x      y      z      CID
      1      18      2      -555.128      86.6      1072.29      9
      2      18      3      -555.128      86.6      1072.29      9
      3      18      3      -580.334      -62.15      1068.32      9
      4      18      1      568.881      81.2945      1033.72      9
      5      18      2      568.881      81.2945      1033.72      9
      6      18      3      568.881      81.2945      1033.74      9
*DEFINE_COORDINATE_SYSTEM
$      CID      X0      Y0      Z0      XL      YL      ZL
      9      0.0      0.0      0.0      0.0      10.0      0.0
$      XP      YP      ZP
      10.0      10.0      0.0

```

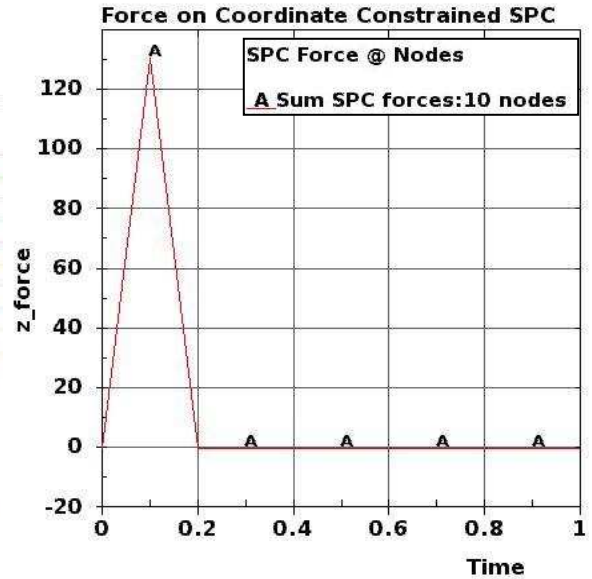
5. It is now possible to output SPC forces on the coordinates constrained. For each position coordinate set, an extra node will be generated and SPC forces are calculated and output to `SPCFORC` file, with frequency specified in keyword `*DATABASE_SPCFORC`. Shown in the following figures are the SPC forces calculated with multi-steps static implicit solution on a springback panel (NUMISHEET 2005 cross member) with over-constrained boundary conditions. This SPC output feature is available in LS-DYNA R5 Revision 62560 and later releases.
6. This feature is now available in LS-DYNA R5 Revision 52619 or later releases and is also supported by Metal Forming GUI in LSPP v3.1, under 'Springback'.



Constrained locations of a springback panel (NUMISHEET 2005 cross member).



SPC Z-forces on 10 nodes.



Z-force summation.



**\*CONSTRAINED\_EULER\_IN\_EULER**

Purpose: This command defines the coupling interaction between EULERIAN materials in two overlapping, geometrically similar, multi-material Eulerian mesh sets. The command allows a frictionless “contact” between two or more different Eulerian materials.

Card            1            2            3            4            5            6            7            8

Variable	PSIDSLV	PSIDMST	PFAC					
Type	I	I	F					
Default	0	0	0.1					

<u>VARIABLE</u>	<u>DESCRIPTION</u>
PSIDSLV	Part set ID of the 1 <sup>st</sup> ALE or Eulerian set of mesh(es) (slave).
PSIDMST	Part set ID of the 2 <sup>nd</sup> ALE or Eulerian set of mesh(es) (master).
PFAC	A penalty factor for the coupling interaction between the two PSIDs.

**Remarks:**

1. The 2 meshes must be of Eulerian formulation (the meshes are fixed in space, not moving). Consider 2 overlapping Eulerian meshes. Each Eulerian mesh contains 2 physical materials, say a vacuum and a metal. This card provides a frictionless “contact” or interaction between the 2 metals, each resides in a different Eulerian mesh system. Due to its restrictive nature, this option is currently only an experimental feature.
2. Contact pressure is built up in two overlapping Eulerian elements if their combined material fill fraction exceeds 1.0 (penalty formulation).
3. This feature needs to be combined with \*MAT\_VACUUM (element formulation 11).

**Example:**

Consider an ALE/Eulerian multi-material model (ELFORM=11) consisting of:

- PID 1 = \*MAT\_NULL (material 1)
- PID 2 = \*MAT\_VACUUM ⇒ PID 1 is merged at its boundary to PID 2.
- PID 3 = \*MAT\_NULL (material 3)

- PID 4 = \*MAT\_VACUUM  $\Rightarrow$  PID 3 is merged at its boundary to PID 4.

The mesh set containing PID 1 & 2 intersects or overlaps with the mesh set containing PID 3 & 4. PID 1 is given an initial velocity in the positive x direction. This will cause material 1 to contact material 3 (note that materials 2 & 4 are void). The interaction between materials 1 & 3 is possible by defining this coupling command. In this case material 1 can flow within the mesh region of PID 1 & 2 only, and material 3 can flow within the mesh region of PID 3 & 4 only.

```
$...|...1...|...2...|...3...|...4...|...5...|...6...|...7...|...8
*ALE_MULTI-MATERIAL_GROUP
$   SID   SIDYTP
    1     1
    2     1
    3     1
    4     1
*CONSTRAINED_EULER_IN_EULER
$   PSID1   PSID2   PENAL
    11      12     0.1
*SET_PART_LIST
    11
    1       2
*SET_PART_LIST
    12
    3       4
$...|...1...|...2...|...3...|...4...|...5...|...6...|...7...|...8
```

**\*CONSTRAINED\_EXTRA\_NODES\_OPTION**

Available options include:

**NODE**

**SET**

Purpose: Define extra nodes for rigid body.

Card	1	2	3	4	5	6	7	8
------	---	---	---	---	---	---	---	---

Variable	PID	NID/NSID	IFLAG					
Type	I	I	I					
Default	none	none	0					

<u>VARIABLE</u>	<u>DESCRIPTION</u>
PID	Part ID of rigid body to which the nodes will be added, see *PART.
NID/NSID	Node (option: _NODE) or node set ID (option: _SET), see *SET_NODE, of added nodes.
IFLAG	This flag is meaningful if and only if the inertia properties of the Part ID are defined in PART_INERTIA. If set to unity, the center-of-gravity, the translational mass, and the inertia matrix of the PID will be updated to reflect the merged nodal masses of the node or node set. If IFLAG is defaulted to zero, the merged nodes will not affect the properties defined in PART_INERTIA since it is assumed the properties already account for merged nodes.

**Remarks:**

Extra nodes for rigid bodies may be placed anywhere, even outside the body, and they are assumed to be part of the rigid body. They have many uses including:

1. The definition of draw beads in metal forming applications by listing nodes along the draw bead.
2. Placing nodes where joints will be attached between rigid bodies.



**\*CONSTRAINED\_GENERALIZED\_WELD\_OPTION\_{OPTION}**

Available options include:

**SPOT**

**FILLET**

**BUTT**

**CROSS\_FILLET**

**COMBINED**

To define an ID for the weld use the option:

**ID**

Purpose: Define spot, fillet, butt, and other types of welds. Coincident nodes are permitted if the local coordinate ID is defined. For the spot weld a local coordinate ID is not required if the nodes are offset. Failures can include both the plastic and brittle failures. These can be used either independently or together. Failure occurs when either criteria is met. The welds may undergo large rotations since the equations of rigid body mechanics are used to update their motion. Weld constraints between solid element nodes are not supported.

**ID Card - Required if the option `_ID` is active on the keyword card.**

Card 1            1            2            3            4            5            6            7            8

Variable	WID								
Type	I								
Default	0								

# \*CONSTRAINED

# \*CONSTRAINED\_GENERALIZED\_WELD

This card is required for all weld options.

Card 1            1            2            3            4            5            6            7            8

Variable	NSID	CID	FILTER	WINDO W	NPR	NPRT		
Type	I	I	I	E	I	I		
Default	none	none						

<u>VARIABLE</u>	<u>DESCRIPTION</u>
WID	Optional weld ID.
NSID	Nodal set ID, see *SET_NODE_OPTION.
CID	Coordinate system ID for output of spot weld data to SWFORC in local system, see *DEFINE_COORDINATE_OPTION. CID is not required for spot welds if the nodes are not coincident.
FILTER	Number of force vectors saved for filtering. This option can eliminate spurious failures due to numerical force spikes; however, memory requirements are significant since 6 force components are stored with each vector. LE.1: no filtering EQ.n: simple average of force components divided by n or the maximum number of force vectors that are stored for the time window option below.
WINDOW	Time window for filtering. This option requires the specification of the maximum number of steps which can occur within the filtering time window. If the time step decreases too far, then the filtering time window will be ignored and the simple average is used. EQ.0: time window is not used
NPR	Number of individual nodal pairs in the cross fillet or combined general weld.
NPRT	Print option in file RBDOUT. EQ.0: default from the control card, *CONTROL_OUTPUT, is used, see variable name IPRTF. EQ.1: data is printed EQ.2: data is not printed

**Additional Card required for the CONSTRAINED\_GENERALIZED\_WELD\_SPOT option:**

Card 2            1            2            3            4            5            6            7            8

Variable	TFAIL	EPSF	SN	SS	N	M		
Type	F	F	F	F	F	F		

**VARIABLE****DESCRIPTION**

TFAIL	Failure time for constraint set, $t_f$ . (default=1.E+20)
EPSF	Effective plastic strain at failure, $\varepsilon_{fail}^p$ defines ductile failure.
SN	$S_n$ , normal force at failure, only for the brittle failure of spot welds.
SS	$S_s$ , shear force at failure, only for the brittle failure of spot welds.
N	n, exponent for normal force, only for the brittle failure of spot welds.
M	m, exponent for shear force, only for the brittle failure of spot welds.

**Remarks:**

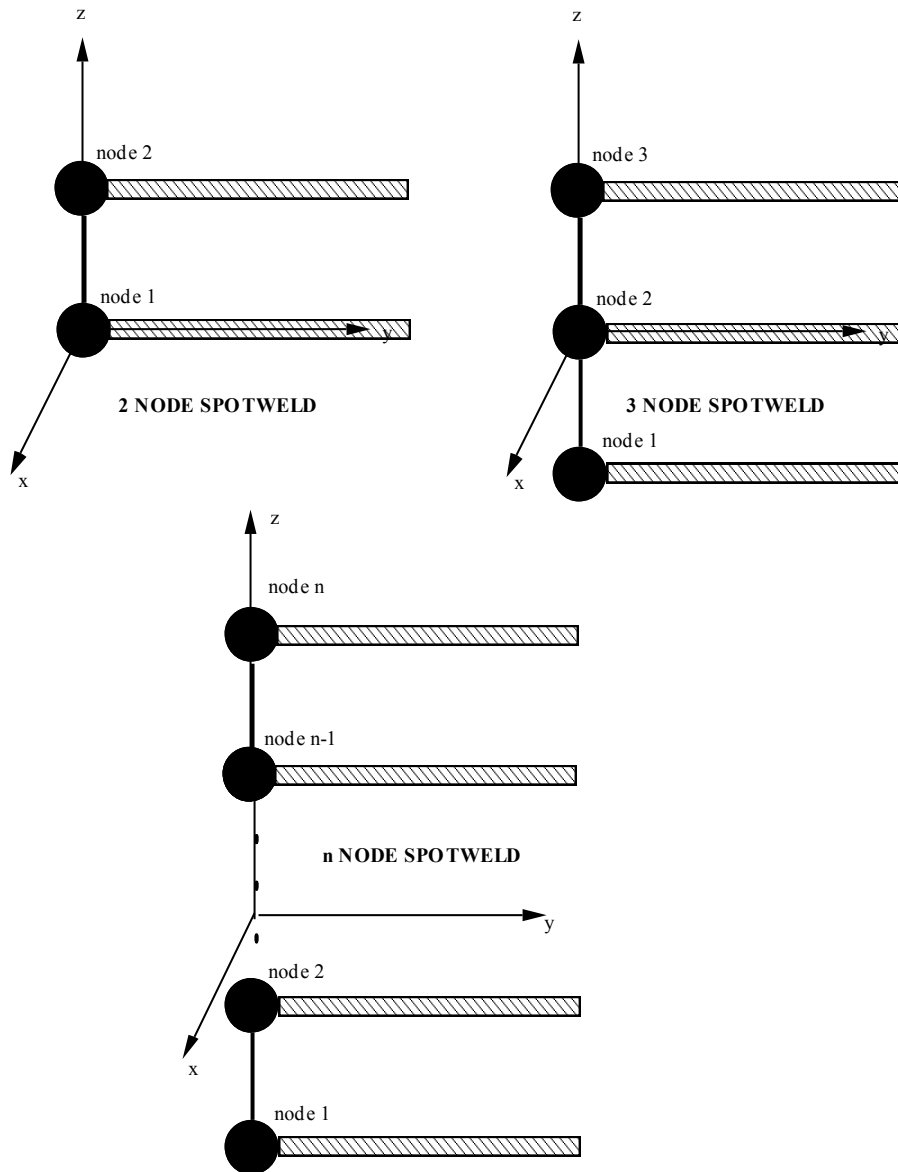
Spot weld failure due to plastic straining occurs when the effective nodal plastic strain exceeds the input value,  $\varepsilon_{fail}^p$ . This option can model the tearing out of a spot weld from the sheet metal since the plasticity is in the material that surrounds the spot weld, not the spot weld itself. A least squares algorithm is used to generate the nodal values of plastic strains at the nodes from the element integration point values. The plastic strain is integrated through the element and the average value is projected to the nodes via a least square fit. This option should only be used for the material models related to metallic plasticity and can result in slightly increased run times.

Brittle failure of the spot welds occurs when:

$$\left(\frac{\max(f_n, 0)}{S_n}\right)^n + \left(\frac{|f_s|}{S_s}\right)^m \geq 1$$

where  $f_n$  and  $f_s$  are the normal and shear interface force. Component  $f_n$  contributes for tensile values only. When the failure time,  $t_f$ , is reached the nodal rigid body becomes inactive and the constrained nodes may move freely. In Figure 9.2 the ordering of the nodes is shown for the 2

node and 3 node spot welds. This order is with respect to the local coordinate system where the local z-axis determines the tensile direction. The nodes in the spot weld may coincide. The failure of the 3 node spot weld may occur gradually with first one node failing and later the second node may fail. For n noded spot welds the failure is progressive starting with the outer nodes (1 and n) and then moving inward to nodes 2 and n-1. Progressive failure is necessary to preclude failures that would create new rigid bodies.



**Figure 9.2.** Nodal ordering and orientation of the local coordinate system is important for determining spotweld failure.



**Additional Card required for the FILLET option:**

Card 2            1            2            3            4            5            6            7            8

Variable	TFAIL	EPSF	SIGF	BETA	L	W	A	ALPHA
Type	F	F	F	F	F	F	F	F

**VARIABLE****DESCRIPTION**

TFAIL	Failure time for constraint set, $t_f$ . (default=1.E+20)
EPSF	Effective plastic strain at failure, $\varepsilon_{fail}^p$ defines ductile failure.
SIGF	$\sigma_f$ , stress at failure for brittle failure.
BETA	$\beta$ , failure parameter for brittle failure.
L	L, length of fillet/butt weld (see Figure 9.2 and 9.3).
W	w, width of flange (see Figure 9.2).
A	a, width of fillet weld (see Figure 9.2).
ALPHA	$\alpha$ , weld angle (see Figure 9.2) in degrees.

**Remarks:**

Ductile fillet weld failure, due to plastic straining, is treated identically to spot weld failure. Brittle failure of the fillet welds occurs when:

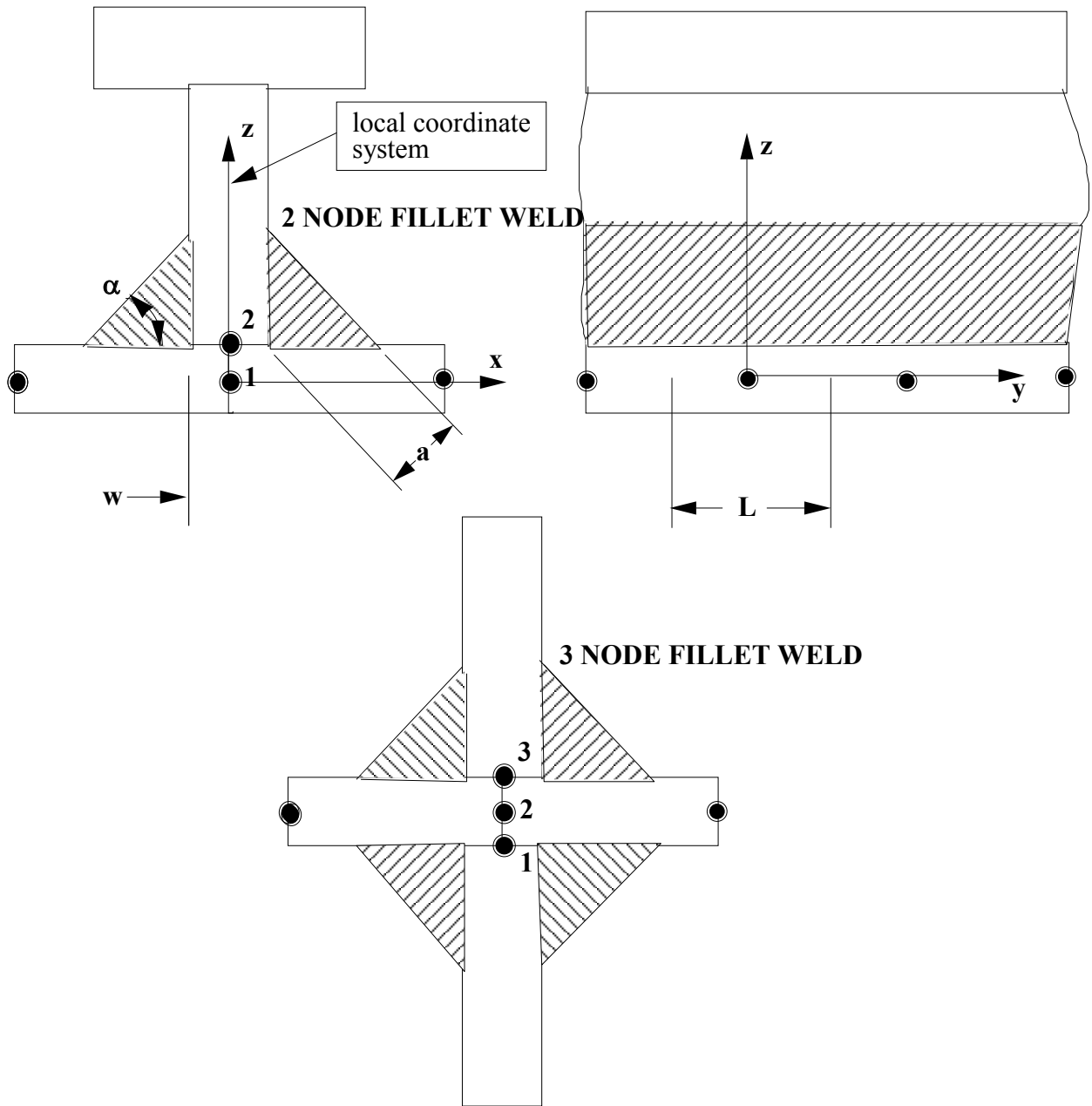
$$\beta \sqrt{\sigma_n^2 + 3(\tau_n^2 + \tau_t^2)} \geq \sigma_f$$

where

$\sigma_n$	= normal stress
$\tau_n$	= shear stress in direction of weld (local y)
$\tau_t$	= shear stress normal to weld (local x)
$\sigma_f$	= failure stress
$\beta$	= failure parameter

Component  $\sigma_n$  is nonzero for tensile values only. When the failure time,  $t_f$ , is reached the nodal rigid body becomes inactive and the constrained nodes may move freely. In Figure 9.2 the ordering of the nodes is shown for the 2 node and 3 node fillet welds. This order is with respect to the local coordinate system where the local z axis determines the tensile direction. The nodes

in the fillet weld may coincide. The failure of the 3 node fillet weld may occur gradually with first one node failing and later the second node may fail.



**Figure 9.3.** Nodal ordering and orientation of the local coordinate system is shown for fillet weld failure. The angle is defined in degrees.

**Additional Card required for the BUTT option:**

Card 2            1            2            3            4            5            6            7            8

Variable	TFAIL	EPSF	SIGY	BETA	L	D	LT	
Type	F	F	F	F	F	F	F	

**VARIABLE****DESCRIPTION**

TFAIL	Failure time for constraint set, $t_f$ . (default=1.E+20)
EPSF	Effective plastic strain at failure, $\varepsilon_{fail}^p$ defines ductile failure.
SIGY	$\sigma_f$ , stress at failure for brittle failure.
BETA	$\beta$ , failure parameter for brittle failure.
L	L, length of fillet/butt weld (see Figure 9.4).
D	d, thickness of butt weld (see Figure 9.4).
LT	$L_t$ , transverse length of butt weld (see Figure 9.4).

**Remarks:**

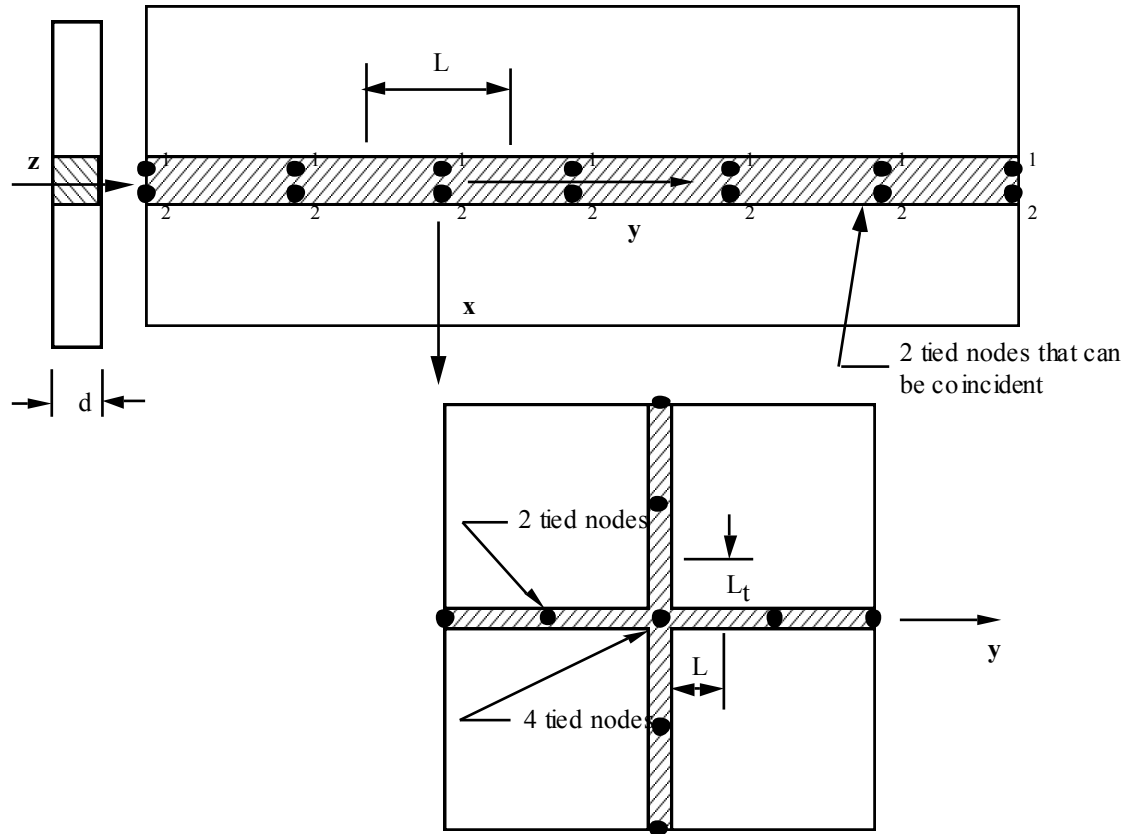
Ductile butt weld failure, due to plastic straining, is treated identically to spot weld failure. Brittle failure of the butt welds occurs when:

$$\beta \sqrt{\sigma_n^2 + 3(\tau_n^2 + \tau_t^2)} \geq \sigma_f$$

where

$\sigma_n$	=	normal stress
$\tau_n$	=	shear stress in direction of weld (local y)
$\tau_t$	=	shear stress normal to weld (local z)
$\sigma_f$	=	failure stress
$\beta$	=	failure parameter

Component  $\sigma_n$  is nonzero for tensile values only. When the failure time,  $t_f$ , is reached the nodal rigid body becomes inactive and the constrained nodes may move freely. The nodes in the butt weld may coincide.



**Figure 9.4.** Orientation of the local coordinate system and nodal ordering is shown for butt weld failure.

```

$$$$$$$$$$$$$$$$$$$$$$$$$$$$$$$$$$$$$$$$$$$$$$$$$$$$$$$$$$$$$$$$$$$$$$$$$$$$$$$$$$$$
$
$$$$ *CONSTRAINED_GENERALIZED_WELD_BUTT
$
$$$$$$$$$$$$$$$$$$$$$$$$$$$$$$$$$$$$$$$$$$$$$$$$$$$$$$$$$$$$$$$$$$$$$$$$$$$$$$$$$$$$
$
$ Weld two plates that butt up against each other at three nodal pair
$ locations. The nodal pairs are 32-33, 34-35 and 36-37.
$
$ This requires 3 separate *CONSTRAINED_GENERALIZED_WELD_BUTT definitions,
$ one for each nodal pair. Each weld is to have a length (L) = 10,
$ thickness (D) = 2, and a transverse length (Lt) = 1.
$
$ Failure is defined two ways:
$ Ductile failure if effective plastic strain exceeds 0.3
$ Brittle failure if the stress failure criteria exceeds 0.25
$ - scale the brittle failure criteria by beta = 0.9.
$ Note: beta > 1 weakens weld beta < 1 strengthens weld
$
*CONSTRAINED_GENERALIZED_WELD_BUTT
$
  
```



# \*CONSTRAINED

# \*CONSTRAINED\_GENERALIZED\_WELD

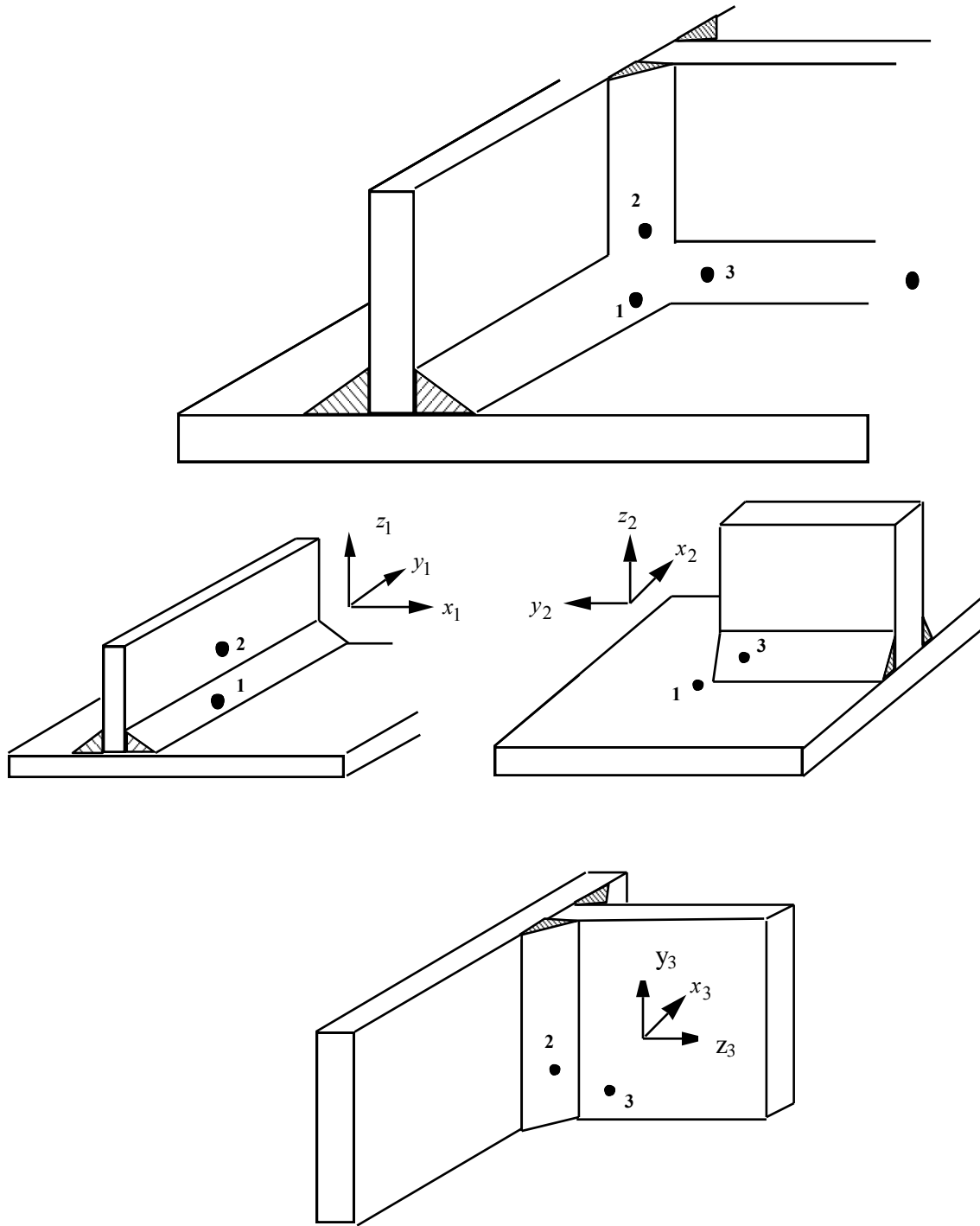
Cards            1            2            3            4            5            6            7            8  
3,4, ...,2+N  
PR

Variable	NODEA	NODEB	NCID					
Type	I	I	I					

## VARIABLE

## DESCRIPTION

TFAIL	Failure time for constraint set, $t_f$ . (default=1.E+20)
EPSF	Effective plastic strain at failure, $\varepsilon_{fail}^p$ defines ductile failure.
SIGY	$\sigma_f$ , stress at failure for brittle failure.
BETA	$\beta$ , failure parameter for brittle failure.
L	L, length of fillet/butt weld (see Figure 9.2 and 9.3).
W	w, width of flange (see Figure 9.2).
A	a, width of fillet weld (see Figure 9.2).
ALPHA	$\alpha$ , weld angle (see Figure 9.2) in degrees.
NODEA	Node ID, A, in weld pair (CROSS or COMBINED option only). See Figure 9.5.
NODEB	Node ID, B, in weld pair (CROSS or COMBINED option only).
NCID	Local coordinate system ID (CROSS or COMBINED option only).



**Figure 9.5.** A simple cross fillet weld illustrates the required input. Here NPR=3 with nodal pairs (A=2, B=1), (A=3, B=1), and (A=3, B=2). The local coordinate axes are shown. These axes are fixed in the rigid body and are referenced to the local rigid body coordinate system which tracks the rigid body rotation.

# \*CONSTRAINED

# \*CONSTRAINED\_GENERALIZED\_WELD

**Additional NPR Card Sets required for the COMBINED option. Repeat cards 2 and 3 below NPR times:**

Card 2            1            2            3            4            5            6            7            8

Variable	TFAIL	EPSF	SIGY	BETA	L	W	A	ALPHA
Type	F	F	F	F	F	F	F	F

Card 3            1            2            3            4            5            6            7            8

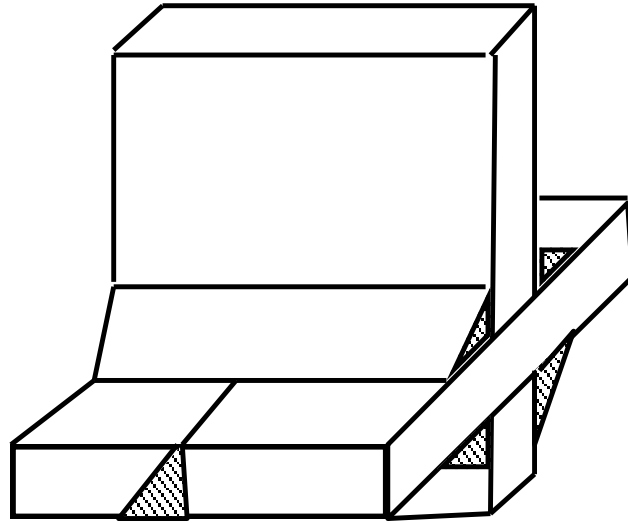
Variable	NODEA	NODEB	NCID	WTYP				
Type	I	I	I	I				

## VARIABLE

## DESCRIPTION

TFAIL	Failure time for constraint set, $t_f$ . (default=1.E+20)
EPSF	Effective plastic strain at failure, $\epsilon_{fail}^p$ defines ductile failure.
SIGY	$\sigma_f$ , stress at failure for brittle failure.
BETA	$\beta$ , failure parameter for brittle failure.
L	L, length of fillet/butt weld (see Figure 9.2 and 9.3).
W	w, width of flange (see Figure 9.2).
A	a, width of fillet weld (see Figure 9.2).
ALPHA	$\alpha$ , weld angle (see Figure 9.2) in degrees.
NODEA	Node ID, A, in weld pair (CROSS or COMBINED option only).
NODEB	Node ID, B, in weld pair (CROSS or COMBINED option only).
NCID	Local coordinate system ID (CROSS or COMBINED option only).
WTYPE	Weld pair type (GENERAL option only). See Figure 9.6. EQ.0: fillet weld EQ.1: butt weld





**Figure 9.6.** A combined weld is a mixture of fillet and butt welds.

# \*CONSTRAINED

\*CONSTRAINED\_GLOBAL

## \*CONSTRAINED\_GLOBAL

Purpose: Define a global boundary constraint plane.

Card	1	2	3	4	5	6	7	8
Variable	TC	RC	DIR	X	Y	Z		
Type	I	I	I	F	F	F		
Default	0	0	0	0	0	0		

### VARIABLE

### DESCRIPTION

TC	Translational Constraint: EQ.1: constrained x translation, EQ.2: constrained y translation, EQ.3: constrained z translation, EQ.4: constrained x and y translations, EQ.5: constrained y and z translations, EQ.6: constrained x and z translations, EQ.7: constrained x, y, and z translations,
RC	Rotational Constraint: EQ.1: constrained x-rotation, EQ.2: constrained y-rotation, EQ.3: constrained z-rotation, EQ.4: constrained x and y rotations, EQ.5: constrained y and z rotations, EQ.6: constrained z and x rotations, EQ.7: constrained x, y, and z rotations.
DIR	Direction of normal EQ.1: global x, EQ.2: global y, EQ.3: global z.
X	x-offset coordinate
Y	y-offset coordinate
Z	z-offset coordinate

**Remarks:**

Nodes within a mesh-size-dependent tolerance are constrained on a global plane. This option is recommended for use with r-method adaptive remeshing where nodal constraints are lost during the remeshing phase.

**\*CONSTRAINED\_INTERPOLATION\_{OPTION}**

Available options include:

**<BLANK>**

**LOCAL**

Purpose: Define an interpolation constraint. With this constraint type, the motion of a single dependent node is interpolated from the motion of a set of independent nodes. This option is useful for the load redistribution of a load, which can be either a translational force or moment, applied to the dependent node to the surrounding independent nodes, and it can also be used to model shell-brick and beam-brick interfaces. The mass and rotary inertia of the dependent nodal point is also redistributed. This constraint is applied in the global coordinate system unless the option LOCAL is active. One \*CONSTRAINED\_INTERPOLATION card is required for each constraint definition. The input list of independent nodes is terminated when the next "\*" card is found. In explicit calculations the independent nodes cannot be dependent nodes in other constraints such as nodal rigid bodies. This latter restriction does not apply to implicit calculations.

Card            1            2            3            4            5            6            7            8

Variable	ICID	DNID	DDOF	CIDD				
Type	I	I	I	I				
Default	0	0	123456	optional				

**Cards 2, 3, 4, etc. Define one card per independent node. If the option LOCAL is active, define two cards per independent node. Input is terminated when a "\*" card is found.**

1            2            3            4            5            6            7            8

Variable	INID	IDOF	TWGHTX	TWGHTY	TWGHTZ	RWGHT X	RWGHT Y	RWGHTZ
Type	I	I	F	F	F	F	F	F
Default	0	123456	1.0	TWGHTX	TWGHTX	TWGHTX	TWGHTX	TWGHTX

Define the second card if and only if the option LOCAL is active

Card            1            2            3            4            5            6            7            8

Variable	CIDI							
Type	I							
Default	0							

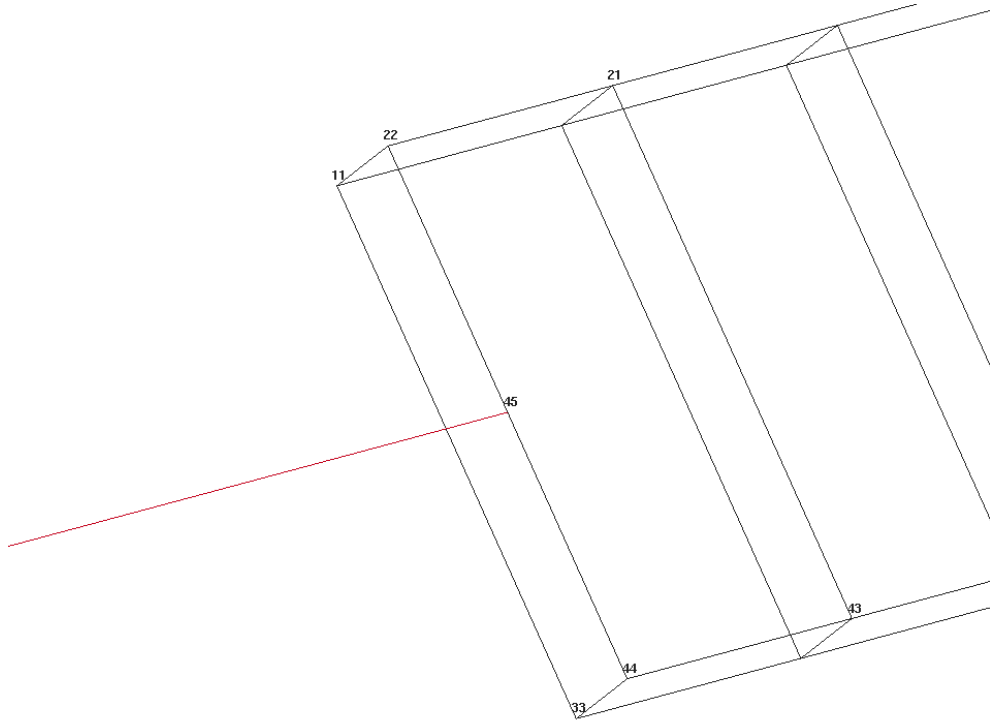
<u>VARIABLE</u>	<u>DESCRIPTION</u>
ICID	Interpolation constraint ID.
DNID	Dependent node ID. This node should not be a member of a rigid body, or elsewhere constrained in the input.
DDOF	Dependent degrees-of-freedom. The list of dependent degrees-of-freedom consists of a number with up to six digits, with each digit representing a degree of freedom. For example, the value 1356 indicates that degrees of freedom 1, 3, 5, and 6 are controlled by the constraint. The default is 123456. Digit: degree of freedom ID's: EQ.1: x EQ.2: y EQ.3: z EQ.4: rotation about x axis EQ.5: rotation about y axis EQ.6: rotation about z axis
CIDD	Local coordinate system ID if LOCAL option is active. If blank the global coordinate system is assumed.
INID	Independent node ID.
IDOF	Independent degrees-of-freedom using the same form as for the dependent degrees-of-freedom, DDOF, above.
TWGHTX	Weighting factor for node INID with active degrees-of-freedom IDOF. This weight scales the x-translational component. It is normally sufficient to define only TWGHTX even if its degree-of-freedom is inactive since the other factors are set equal to this input value as the default. There is no requirement on the values that are chosen as the weighting factors, i.e., that they sum to unity. The default value for the weighting factor is unity.

<u>VARIABLE</u>	<u>DESCRIPTION</u>
TWGHTY	Weighting factor for node INID with active degrees-of-freedom IDOF. This weight scales the y-translational component.
TWGHTZ	Weighting factor for node INID with active degrees-of-freedom IDOF. This weight scales the z-translational component.
RWGHTX	Weighting factor for node INID with active degrees-of-freedom IDOF. This weight scales the x-rotational component.
RWGHTY	Weighting factor for node INID with active degrees-of-freedom IDOF. This weight scales the y-rotational component.
RWGHTZ	Weighting factor for node INID with active degrees-of-freedom IDOF. This weight scales the z-rotational component.
CIDI	Local coordinate system ID if LOCAL option is active. If blank the global coordinate system is assumed.

```

$$$$$$$$$$$$$$$$$$$$$$$$$$$$$$$$$$$$$$$$$$$$$$$$$$$$$$$$$$$$$$$$$$$$$$$$$$$$$$$$$$$$$$$$$$$$
$
$$$$ *CONSTRAINED_INTERPOLATION (Beam to solid coupling)
$
$$$$$$$$$$$$$$$$$$$$$$$$$$$$$$$$$$$$$$$$$$$$$$$$$$$$$$$$$$$$$$$$$$$$$$$$$$$$$$$$$$$$$$$$$$$$
$
$ Tie a beam element to a solid element.
$
$ The node of the beam to be tied does not share a common node with the solids.
$ If the beam node is shared, for example, then set ddof=456.
$
*CONSTRAINED_INTERPOLATION
$
$.>...>...1...>...2...>...3...>...4...>...5...>...6...>...7...>...8
$   icid   dnid   ddof
$     1     45   123456
$   inid   idof   twghtx   twghty   twghtz   rwghtx   rwghty   rwghtz
$     22     123
$     44     123
$     43     123
$
*.....
$

```

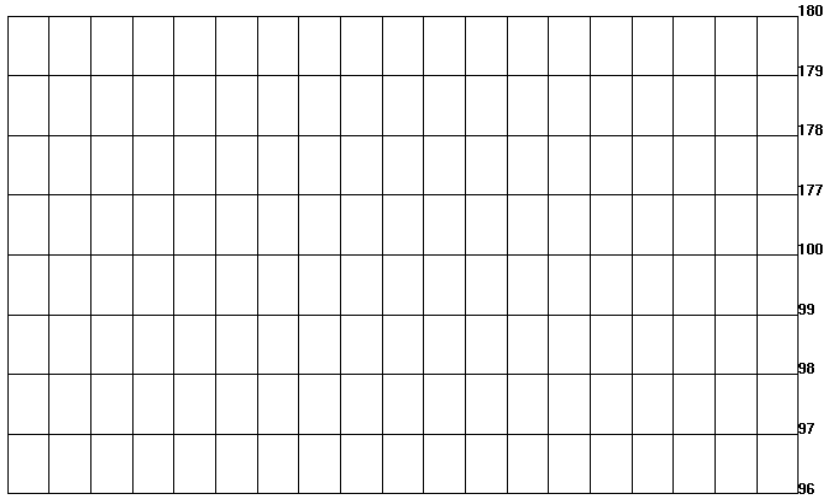


```

$$$$$$$$$$$$$$$$$$$$$$$$$$$$$$$$$$$$$$$$$$$$$$$$$$$$$$$$$$$$$$$$$$$$$$$$$$$$$$$$$$$$
$
$$$$ *CONSTRAINED_INTERPOLATION (Load redistribution)
$
$$$$$$$$$$$$$$$$$$$$$$$$$$$$$$$$$$$$$$$$$$$$$$$$$$$$$$$$$$$$$$$$$$$$$$$$$$$$$$$$$$$$
$
$ Moment about normal axis of node 100 is converted to an equivalent load by
$ applying x-force resultants to the nodes lying along the right boundary
$
*DEFINE_CURVE
1,0,0.,0.,0.,0.,0
0.,0.
.1,10000.
*LOAD_NODE_POINT
100,6,1,1.0
$
*CONSTRAINED_INTERPOLATION
$
$...>...1...>...2...>...3...>...4...>...5...>...6...>...7...>...8
$  icid      dnid      ddof
$    1        100       5
$  inid      idof      twghtx   twghty   twghtz   rwghtx   rwghty   rwghtz
$    96        1
$    97        1
$    98        1
$    99        1
$   177        1
$   178        1
$   179        1
$   180        1

```

⊘  
\* .....  
⊘





**\*CONSTRAINED\_INTERPOLATION\_SPOTWELD**

Purpose: Define a spotweld with failure. This model includes a plasticity-damage model that reduces the force and moment resultants to zero as the spotweld fails. The location of the spotweld is defined by a single node at the center of two connected sheets. The domain of influence is specified by a radius, which should be approximately equal to the spotweld’s radius. The algorithm does a normal projection from the two sheets to the spotweld node and locates all nodes within the user-defined diameter of influence. The numerical implementation of this model is similar to the SPR2 model (\*CONSTRAINED\_SPR2).

Card 1            1            2            3            4            5            6            7            8

Variable	PID1	PID2	NSID	THICK	R	STIFF	ALPHA1	
Type	I	I	I	F	F	F	F	
Default	none	none	none	none	none	none	none	

Card 2            1            2            3            4            5            6            7            8

Variable	RN	RS	BETA	LCF	LCUPF	LCUPR	DENS	INTP
Type	F	F	F	F	F	F	F	F
Default	none	none	none	none	none	none	none	none

<u>VARIABLE</u>	<u>DESCRIPTION</u>
PID1	Part ID of first sheet.
PID2	Part ID of second sheet.
NSID	Node set ID of spotweld location nodes.
THICK	Total thickness of both sheets.
R	Spotweld radius.
STIFF	Elastic stiffness.

<b>VARIABLE</b>	<b>DESCRIPTION</b>
ALPHA1	Scaling factor.
RN	Tensile strength factor.
RS	Shear strength factor.
BETA	Exponent for plastic potential.
LCF	Load curve ID describing force versus plastic displacement: $F^0(\bar{u}^{pl})$ .
LCUPF	Load curve ID describing plastic initiation displacement versus mode mixity: $\bar{u}_0^{pl}(\kappa)$ .
LCUPR	Load curve ID describing plastic rupture displacement versus mode mixity: $\bar{u}_f^{pl}(\kappa)$ .
DENS	Spotweld density (necessary for time step calculation).
INTP	Flag for interpolation. EQ.0: linear (default), EQ.1: uniform, EQ.2: inverse distance weighting.

**Remarks:**

This numerical model is similar to the self-piercing rivet model SPR2 (see \*CONSTRAINED\_SPR2) but with some differences to make it more suitable for spotwelds. The first difference is symmetric behavior of the spotweld connection, i.e. there is no distinction between a master sheet and a slave sheet. This is done by averaging the normals of both parts and by always distributing the balance moments equally to both sides.

The second difference is that there are not only two but three quantities to describe the kinematics, namely the normal relative displacement  $\delta_n$ , the tangential relative displacement  $\delta_t$ , and the relative rotation  $\omega_b$  - all with respect to the plane-of-maximum opening. I.e. a relative displacement vector is defined as

$$\mathbf{u} = [\delta_n, \delta_t, \omega_b]$$

The third difference is the underlying material model. With the described kinematic quantities, an elastic effective force vector is computed first:

$$\tilde{\mathbf{f}} = [f_n, f_t, m_b] = \text{STIFF} \cdot \mathbf{u} = \text{STIFF} \cdot [\delta_n, \delta_t, \omega_b]$$

From that, two resultant forces for normal direction and tangential direction (shear) are computed via

$$F_n = \langle f_n \rangle + \alpha_1 m_b, \quad F_s = f_t$$

Then, a yield function is defined for plastic behavior

$$\phi(\tilde{\mathbf{f}}, \bar{u}^{pl}) = P(\tilde{\mathbf{f}}) - F^0(\bar{u}^{pl}) \leq 0$$

with relative plastic displacement  $\bar{u}^{pl}$ , potential P

$$P(\tilde{\mathbf{f}}) = \left[ \left( \frac{F_n}{R_n} \right)^\beta + \left( \frac{F_s}{R_s} \right)^\beta \right]^{1/\beta}$$

and isotropic hardening described by load curve LCF (see Figure 9.7):

$$F^0 = F^0(\bar{u}^{pl})$$

In addition, a linear softening evolution is incorporated, where damage is defined as:

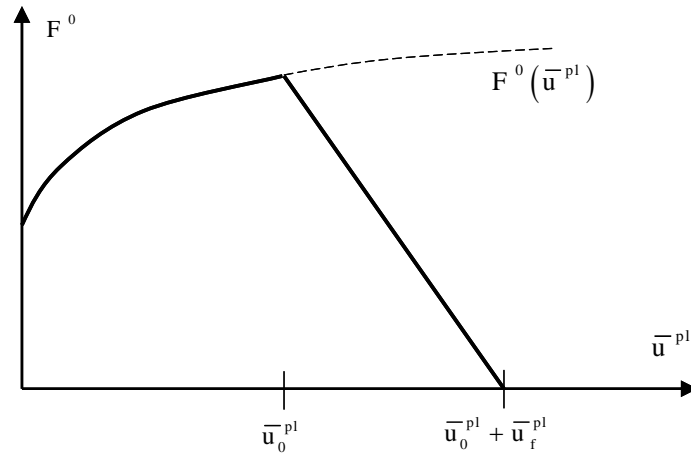
$$d = \frac{\bar{u}^{pl} - \bar{u}_0^{pl}(\kappa)}{\bar{u}_f^{pl}(\kappa)}, \quad 0 < d < 1$$

with mode mixity

$$\kappa = \frac{2}{\pi} \arctan \left( \frac{F_n}{F_s} \right), \quad 0 < \kappa < 1$$

Finally, the nominal force is computed as:

$$\mathbf{f} = (1 - d) \tilde{\mathbf{f}}$$



**Figure 9.7.** Force-displacement curve: plasticity and linear damage

**\*CONSTRAINED\_JOINT\_OPTION\_{OPTION}\_{OPTION}\_{OPTION}**

Available forms include (one is mandatory):

**CONSTRAINED\_JOINT\_SPHERICAL**  
**CONSTRAINED\_JOINT\_REVOLUTE**  
**CONSTRAINED\_JOINT\_CYLINDRICAL**  
**CONSTRAINED\_JOINT\_PLANAR**  
**CONSTRAINED\_JOINT\_UNIVERSAL**  
**CONSTRAINED\_JOINT\_TRANSLATIONAL**  
**CONSTRAINED\_JOINT\_LOCKING**  
**CONSTRAINED\_JOINT\_TRANSLATIONAL\_MOTOR**  
**CONSTRAINED\_JOINT\_ROTATIONAL\_MOTOR**  
**CONSTRAINED\_JOINT\_GEAR**  
**CONSTRAINED\_JOINT\_RACK\_AND\_PINION**  
**CONSTRAINED\_JOINT\_CONSTANT\_VELOCITY**  
**CONSTRAINED\_JOINT\_PULLEY**  
**CONSTRAINED\_JOINT\_SCREW**

If the force output data is to be transformed into a local coordinate use the option:

**LOCAL**

to define a joint ID and heading the following option is available:

**ID**

and to define failure for penalty-based joints (LMF=0 in \*CONTROL\_RIGID) use:

**FAILURE**

The ordering of the bracketed options is arbitrary.

Purpose: Define a joint between two rigid bodies, see Figure 9.8.

**Card Format:**

Card 1 is required for all joint types.

Card 2 is required for joint types: MOTOR, GEARS, RACK\_AND\_PINION, PULLEY, and SCREW

Optional Card is required only if LOCAL is specified in the keyword.

In the first seven joint types above excepting the Universal joint, the nodal points within the nodal pairs (1,2), (3,4), and (5,6) (see Figure 9.8) should coincide in the initial configuration, and the nodal pairs should be as far apart as possible to obtain the best behavior. For the Universal



<u>VARIABLE</u>	<u>DESCRIPTION</u>
N1	Node 1, in rigid body A. Define for all joint types.
N2	Node 2, in rigid body B. Define for all joint types.
N3	Node 3, in rigid body A. Define for all joint types except SPHERICAL.
N4	Node 4, in rigid body B. Define for all joint types except SPHERICAL.
N5	Node 5, in rigid body A. Define for joint types TRANSLATIONAL, LOCKING, ROTATIONAL_MOTOR, CONSTANT_VELOCITY, GEARS, RACK_AND_PINION, PULLEY, and SCREW
N6	Node 6, in rigid body B. Define for joint types TRANSLATIONAL, LOCKING, ROTATIONAL_MOTOR, CONSTANT_VELOCITY, GEARS, RACK_AND_PINION, PULLEY, and SCREW
RPS	Relative penalty stiffness (default = 1.0).
DAMP	Damping scale factor on default damping value. (Revolute and Spherical Joints): EQ.0.0: default is set to 1.0, GT.0.0 and LE.0.01: no damping is used.

**Card 2. Required for joint types MOTOR, GEARS, RACK\_AND\_PINION, PULLEY, and SCREW only.**

Card 1	1	2	3	4	5	6	7	8
Variable	PARAM	LCID	TYPE	R1				
Type	F	I	I	F				
Default	None							

<u>VARIABLE</u>	<u>DESCRIPTION</u>
PARAM	Parameter which a function of joint type. Leave blank for MOTORS. Gears: define $R_2/R_1$ Rack and Pinion: define $h$ Pulley: define $R_2/R_1$ Screw: define $\dot{x}/\omega$

<u>VARIABLE</u>	<u>DESCRIPTION</u>
LCID	Define load curve ID for MOTOR joints.
TYPE	Define integer flag for MOTOR joints as follows: EQ.0: translational/rotational velocity EQ.1: translational/rotational acceleration EQ.2: translational/rotational displacement
R1	Radius, $R_1$ , for the gear and pulley joint type. If left undefined, nodal points 5 and 6 are assumed to be on the outer radius. R1 is the moment arm that goes into calculating the joint reaction forces. The ratio $R2/R1$ gives the transmitted moments, but not the forces. The force is moment divided by distance R1.

**Optional: Required only if LOCAL is specified after the keyword.**

Card 1            1            2            3            4            5            6            7            8

Variable	RAID	LST							
Type	I	I							
Default	0	0							

<u>VARIABLE</u>	<u>DESCRIPTION</u>
RAID	Rigid body or accelerometer ID. The force resultants are output in the local system of the rigid body or accelerometer.
LST	Flag for local system type: EQ.0: rigid body EQ.1: accelerometer



**Optional: Required only if FAILURE is specified after the keyword.**

Card 1            1            2            3            4            5            6            7            8

Variable	CID	TFAIL	COUPL					
Type	I	F	F					
Default	0	0	0.					

Card 2            1            2            3            4            5            6            7            8

Variable	NXX	NYX	NZZ	MXX	MYX	MZZ		
Type	F	F	F	F	F	F		
Default	0	0	0	0	0	0		

**VARIABLE****DESCRIPTION**

CID	Coordinate ID for resultants in the failure criteria. If zero, the global coordinate system is used.
TFAIL	Time for joint failure. If zero, joint never fails.
COUPL	Coupling between the force and moment failure criteria. If COUPL is less than or equal to zero, the failure criteria is identical to the spotwelds. When COUPL is greater than zero, the force and moment results are considered independently. See the remark below.
NXX	Axial force resultant $N_{xx_F}$ at failure. If zero, failure due to this component is not considered.
NYX	Force resultant $N_{yy_F}$ at failure. If zero, failure due to this component is not considered.
NZZ	Force resultant $N_{zz_F}$ at failure. If zero, failure due to this component is not considered.

<b>VARIABLE</b>	<b>DESCRIPTION</b>
MXX	Torsional moment resultant $M_{xx_F}$ at failure. If zero, failure due to this component is not considered.
MYY	Moment resultant $M_{yy_F}$ at failure. If zero, failure due to this component is not considered.
MZZ	Moment resultant $M_{zz_F}$ at failure. If zero, failure due to this component is not considered.

**Remarks:**

The moments for the revolute, cylindrical, planar, translational, and locking joints are calculated at the midpoint of nodes N1 and N3. The moments for the spherical, universal, constant velocity, gear, pulley, and rack and pinion joints are calculated at node N1.

When COUPL is less than or equal to zero, the failure criteria is

$$\left(\frac{N_{xx}}{N_{xx_F}}\right)^2 + \left(\frac{N_{yy}}{N_{yy_F}}\right)^2 + \left(\frac{N_{zz}}{N_{zz_F}}\right)^2 + \left(\frac{M_{xx}}{M_{xx_F}}\right)^2 + \left(\frac{M_{yy}}{M_{yy_F}}\right)^2 + \left(\frac{M_{zz}}{M_{zz_F}}\right)^2 - 1 = 0$$

otherwise, it is

$$\left(\frac{N_{xx}}{N_{xx_F}}\right)^2 + \left(\frac{N_{yy}}{N_{yy_F}}\right)^2 + \left(\frac{N_{zz}}{N_{zz_F}}\right)^2 - 1 = 0 \text{ and } \left(\frac{M_{xx}}{M_{xx_F}}\right)^2 + \left(\frac{M_{yy}}{M_{yy_F}}\right)^2 + \left(\frac{M_{zz}}{M_{zz_F}}\right)^2 - 1 = 0.$$

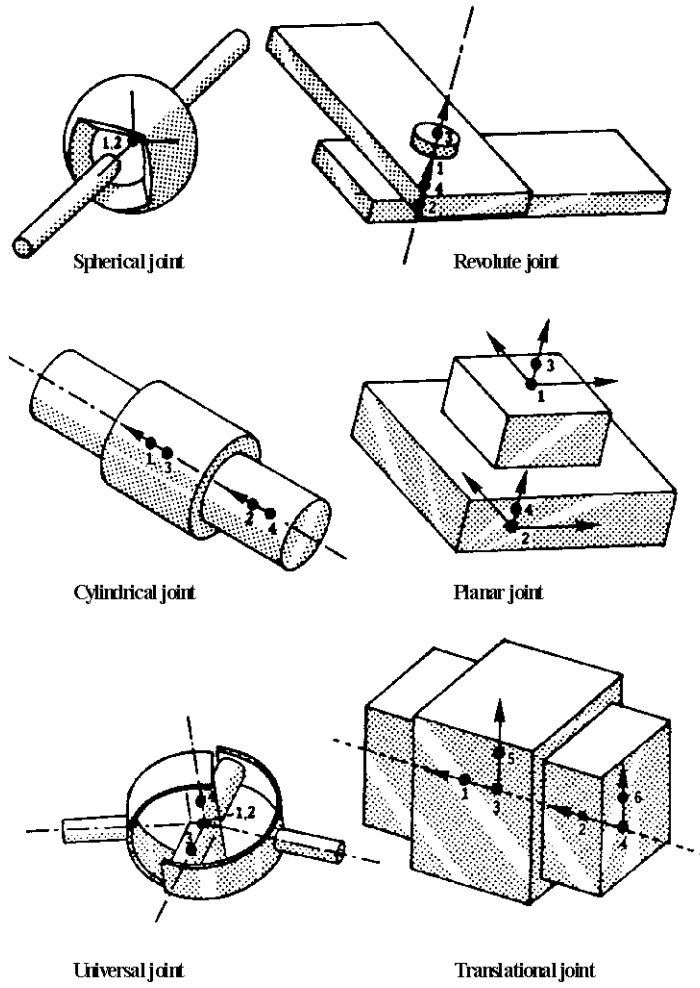


Figure 9.8 Joint definitions 1-6.

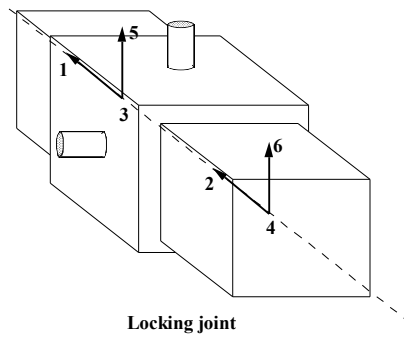
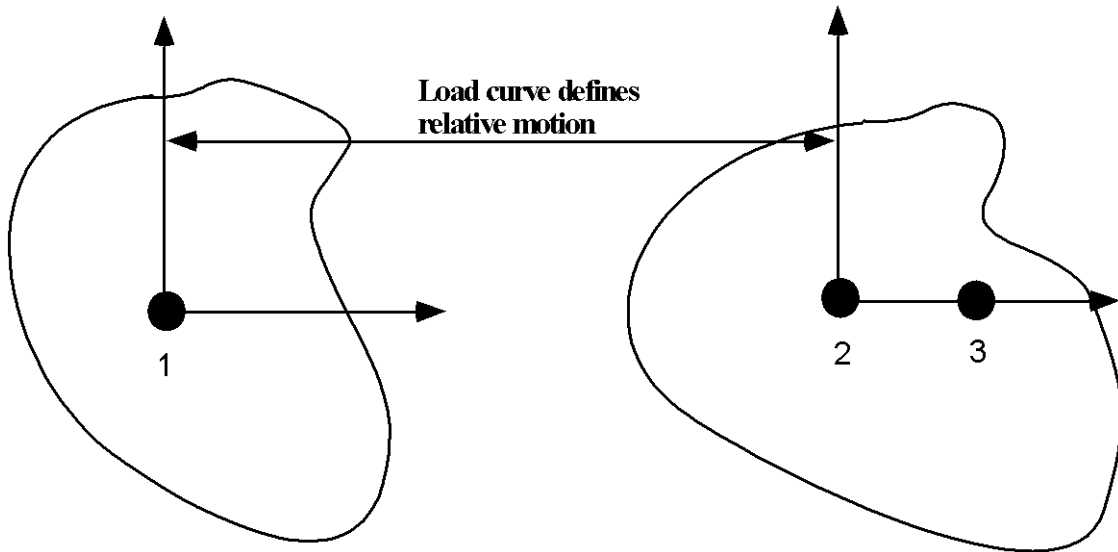
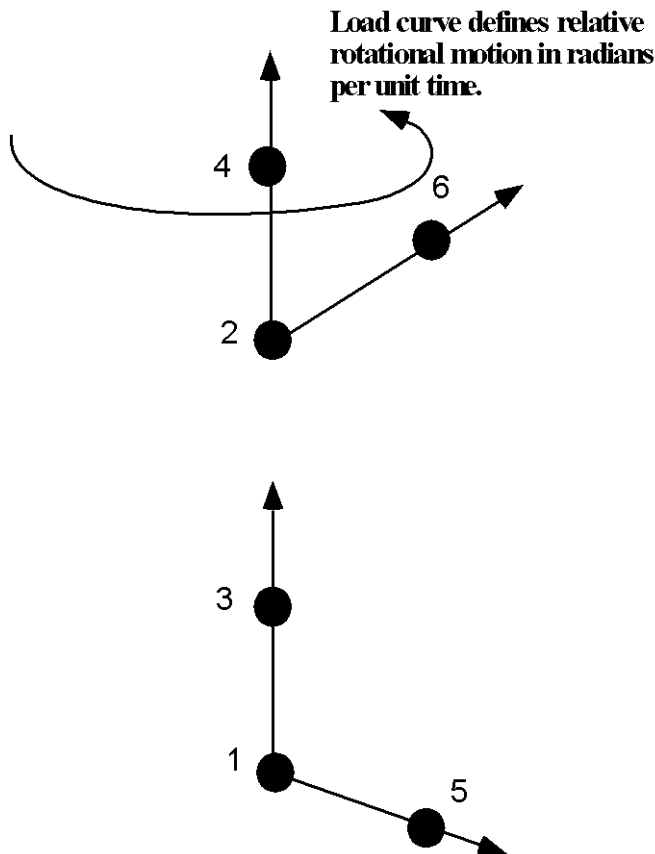


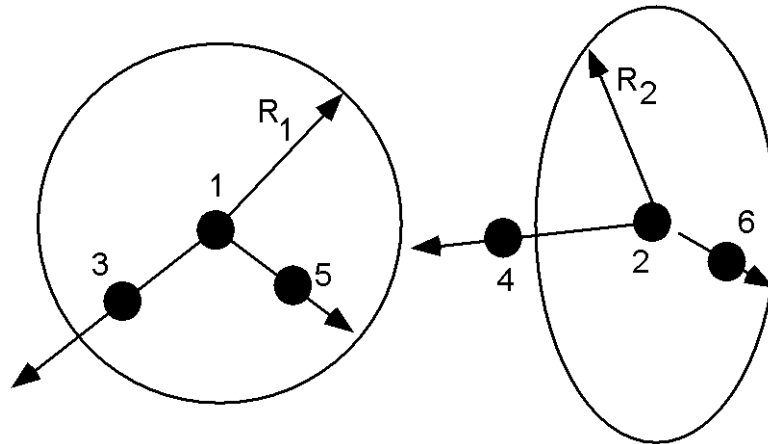
Figure 9.9. Locking joint.



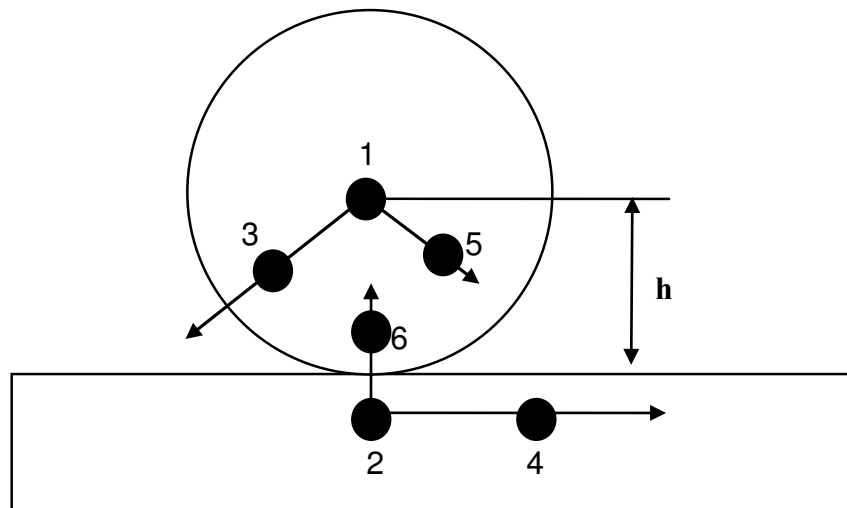
**Figure 9.10.** Translational motor joint. This joint can be used in combination with the translational or the cylindrical joint.



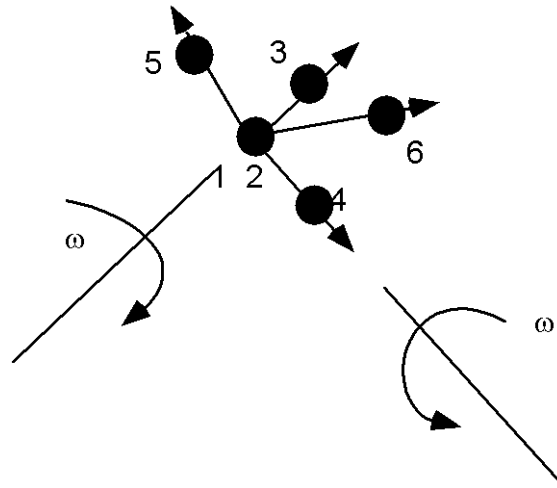
**Figure 9.11.** Rotational motor joint. This joint can be used in combination with other joints such as the revolute or cylindrical joints.



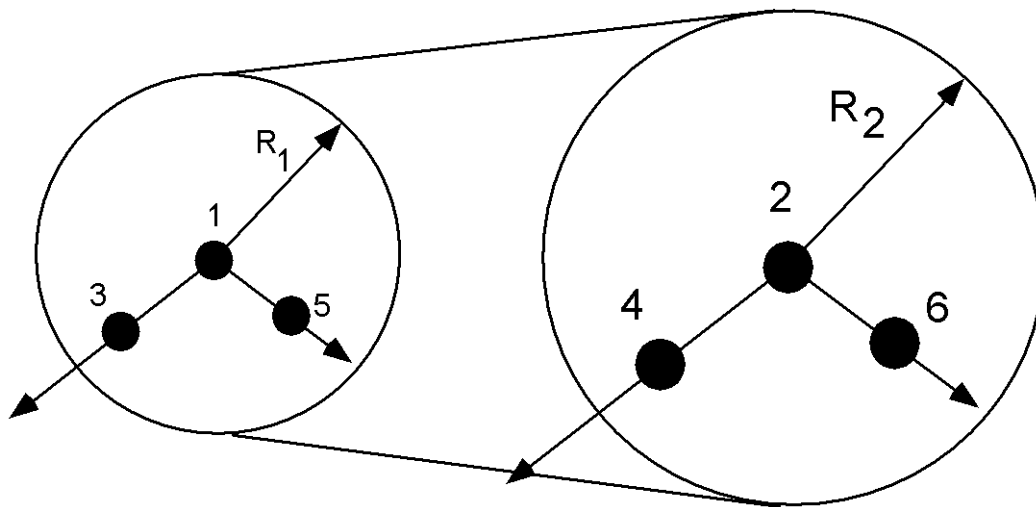
**Figure 9.12.** Gear joint. Nodal pairs (1,3) and (2,4) define axes that are orthogonal to the gears. Nodal pairs (1,5) and (2,6) define vectors in the plane of the gears. The ratio  $\frac{R_2}{R_1}$  is specified.



**Figure 9.13.** Rack and pinion joint. Nodal pair (1,3) defines the axis of rotation of the first body (the pinion). Nodal pair (1,5) is a vector in the plane of the pinion and is orthogonal to nodal pair (1,3). Nodal pair (2,4) defines the direction of travel for the second body (the rack). Nodal pair (2,6) is parallel to the axis of the pinion and is thus parallel to nodal pair (1,3). The value  $h$  is specified. The velocity of the rack is  $\omega_{\text{pinion}} \times h$ .



**Figure 9.14.** Constant velocity joint. Nodal pairs (1,3) and (2,4) define an axes for the constant angular velocity, and nodal pairs (1,5) are orthogonal vectors. Here nodal points 1 and 2 must be coincident.



**Figure 9.15.** Pulley joint. Nodal pairs (1,3) and (2,4) define axes that are orthogonal to the pulleys. Nodal pairs (1,5) and (2,6) define vectors in the plane of the pulleys. The ratio  $\frac{R_2}{R_1}$  is specified.







**\*CONSTRAINED\_JOINT\_COOR\_OPTION\_{OPTION}\_{OPTION}\_{OPTION}**

Available forms include (one is mandatory):

**CONSTRAINED\_JOINT\_COOR\_SPHERICAL**  
**CONSTRAINED\_JOINT\_COOR\_REVOLUTE**  
**CONSTRAINED\_JOINT\_COOR\_CYLINDRICAL**  
**CONSTRAINED\_JOINT\_COOR\_PLANAR**  
**CONSTRAINED\_JOINT\_COOR\_UNIVERSAL**  
**CONSTRAINED\_JOINT\_COOR\_TRANSLATIONAL**  
**CONSTRAINED\_JOINT\_COOR\_LOCKING**  
**CONSTRAINED\_JOINT\_COOR\_TRANSLATIONAL\_MOTOR**  
**CONSTRAINED\_JOINT\_COOR\_ROTATIONAL\_MOTOR**  
**CONSTRAINED\_JOINT\_COOR\_GEAR**  
**CONSTRAINED\_JOINT\_COOR\_RACK\_AND\_PINION**  
**CONSTRAINED\_JOINT\_COOR\_CONSTANT\_VELOCITY**  
**CONSTRAINED\_JOINT\_COOR\_PULLEY**  
**CONSTRAINED\_JOINT\_COOR\_SCREW**

If the force output data is to be transformed into a local coordinate use the option:

**LOCAL**

to define a joint ID and heading the following option is available:

**ID**

and to define failure for penalty-based joints (LMF=0 in \*CONTROL\_RIGID) use:

**FAILURE**

The ordering of the bracketed options is arbitrary.

Purpose: Define a joint between two rigid bodies, see Figure 9.8. The connection coordinates are given instead of the nodal point IDs required in the previous section, \*CONSTRAINED\_JOINT\_{Joint\_Type}. Nodes are automatically generated for each coordinate and are constrained to the rigid body. Where coincident nodes are expected in the initial configuration, only one connection coordinate is needed since the connection coordinate for the second node, if given, is ignored. The created nodal ID's are chosen to exceed the maximum user ID. The coordinates of the joint nodes are specified on Cards 2-7. The input which follows Card 7 is identical to that in the previous section.



Card 1            1            2            3            4            5            6            7            8

Variable	RBID_A	RBID_B	RPS	DAMP	TMASS	RMASS		
Type	I	I	F	F	F	F		

Card 2            1            2            3            4            5            6            7            8

Variable	X1	Y1	Z1					
Type	F	F	F					

Card 3            1            2            3            4            5            6            7            8

Variable	X2	Y2	Z2					
Type	F	F	F					

Card 4            1            2            3            4            5            6            7            8

Variable	X3	Y3	Z3					
Type	F	F	F					

Card 5            1            2            3            4            5            6            7            8

Variable	X4	Y4	Z4					
Type	F	F	F					

Card 6            1            2            3            4            5            6            7            8

Variable	X5	Y5	Z5					
Type	F	F	F					

Card 7            1            2            3            4            5            6            7            8

Variable	X6	Y6	Z6					
Type	F	F	F					

**VARIABLE****DESCRIPTION**

RBID_A	Part ID of rigid body A.
RBID_B	Part ID of rigid body B.
RPS	Relative penalty stiffness (default = 1.0).
DAMP	Damping scale factor on default damping value. (Revolute and Spherical Joints): EQ.0.0: default is set to 1.0, GT.0.0 and LE.0.01: no damping is used.
TMASS	Lumped translational mass. The mass is equally split between the first points defined for rigid bodies A and B.
RMASS	Lumped rotational inertia. The inertia is equally split between the first points defined for rigid bodies A and B.
X1, Y1, Z1	Coordinate of point 1, in rigid body A. Define for all joint types.
X2, Y2, Z2	Coordinate of point 2, in rigid body B. If points 1 and 2 are coincident in the specified joint type, the coordinate for point 1 is used.
X3, Y3, Z3	Coordinate of point 3, in rigid body A. Define for all joint types.
X4, Y4, Z4	Coordinate of point 4, in rigid body B. If points 3 and 4 are coincident in the specified joint type, the coordinate for point 3 is used.

VARIABLE	DESCRIPTION
X5, Y5, Z5	Coordinate of point 5, in rigid body A. Define for all joint types.
X6, Y6, Z6	Coordinate of point 6, in rigid body B. If points 5 and 6 are coincident in the specified joint type, the coordinate for point 5 is used.

**Card 8. Required for joint types MOTOR, GEARS, RACK\_AND\_PINION, PULLEY, and SCREW only.**

Card 1	1	2	3	4	5	6	7	8
Variable	PARAM	LCID	TYPE	R1				
Type	F	I	I	F				
Default	None							

VARIABLE	DESCRIPTION
PARAM	Parameter which a function of joint type. Leave blank for MOTORS. Gears: define $R_2/R_1$ Rack and Pinion: define $h$ Pulley: define $R_2/R_1$ Screw: define $\dot{x}/\omega$
LCID	Define load curve ID for MOTOR joints.
TYPE	Define integer flag for MOTOR joints as follows: EQ.0: translational/rotational velocity EQ.1: translational/rotational acceleration EQ.2: translational/rotational displacement
R1	Radius, $R_1$ , for the gear and pulley joint type. If left undefined, nodal points 5 and 6 are assumed to be on the outer radius. R1 is the moment arm that goes into calculating the joint reaction forces. The ratio $R_2/R_1$ gives the transmitted moments, but not the forces. The force is moment divided by distance R1.

# \*CONSTRAINED

# \*CONSTRAINED\_JOINT\_COOR

**Optional: Required only if LOCAL is specified after the keyword.**

Optional      1            2            3            4            5            6            7            8

Variable	RAID	LST						
Type	I	I						
Default	0	0						

## VARIABLE

## DESCRIPTION

RAID            Rigid body or accelerometer ID. The force resultants are output in the local system of the rigid body or accelerometer.

LST            Flag for local system type:  
EQ.0: rigid body  
EQ.1: accelerometer

**Optional cards: Required only if FAILURE is specified after the keyword.**

Optional 1      1            2            3            4            5            6            7            8

Variable	CID	TFAIL	COUPL					
Type	I	F	F					
Default	0	0	0.					

Optional 2      1            2            3            4            5            6            7            8

Variable	NXX	NYX	NZZ	MXX	MYX	MZZ		
Type	F	F	F	F	F	F		
Default	0	0	0	0	0	0		

**VARIABLE****DESCRIPTION**

CID	Coordinate ID for resultants in the failure criteria. If zero, the global coordinate system is used.
TFAIL	Time for joint failure. If zero, joint never fails.
COUPL	Coupling between the force and moment failure criteria. If COUPL is less than or equal to zero, the failure criteria is identical to the spotwelds. When COUPL is greater than zero, the force and moment results are considered independently. See the remark below.
NXX	Axial force resultant $N_{xxF}$ at failure. If zero, failure due to this component is not considered.
NYX	Force resultant $N_{yyF}$ at failure. If zero, failure due to this component is not considered.
NZZ	Force resultant $N_{zzF}$ at failure. If zero, failure due to this component is not considered.
MXX	Torsional moment resultant $M_{xxF}$ at failure. If zero, failure due to this component is not considered.
MYX	Moment resultant $M_{xxF}$ at failure. If zero, failure due to this component is not considered.
MZZ	Moment resultant $M_{zzF}$ at failure. If zero, failure due to this component is not considered.

**\*CONSTRAINED\_JOINT\_STIFFNESS\_OPTION\_{OPTION}**

Available options include:

**FLEXION-TORSION**

**GENERALIZED**

**TRANSLATIONAL**

If desired a description of the joint stiffness can be provided with the option:

**TITLE**

which is written into the D3HSP and JNTFORC files.

Purpose: Define optional rotational and translational joint stiffness for joints defined by \*CONSTRAINED\_JOINT\_OPTION. These definitions apply to all joints even though degrees of freedom that are considered in the joint stiffness capability may be constrained out in some joint types. The energy that is dissipated with the joint stiffness option is written for each joint in joint force file with the default name, JNTFORC. In the global energy balance this energy is included with the energy of the discrete elements, i.e., the springs and dampers.

**Card Formats:**

The optional TITLE card and card 1 are common to all joint stiffness types.  
Cards 2 to 4 are unique for each stiffness type.

**The following card is read if and only if the TITLE option is specified.**

Optional 1

Variable	TITLE
Type	A80



Card 1            1            2            3            4            5            6            7            8

Variable	JSID	PIDA	PIDB	CIDA	CIDB	JID		
Type	I	I	I	I	I	I		
Default	none	none	none	none	CIDA	none		

**VARIABLE****DESCRIPTION**

TITLE	Description of joint stiffness for output files JNTFORC and D3HSP.
JSID	Joint stiffness ID
PIDA	Part ID for rigid body A, see *PART.
PIDB	Part ID for rigid body B, see *PART.
CIDA	Coordinate ID for rigid body A, see *DEFINE_COORDINATE_OPTION. For the translational stiffness the local coordinate system must be defined by nodal points, *DEFINE_COORDINATE_NODES, since the first nodal point in each coordinate system is used to track the motion.
CIDB	Coordinate ID for rigid body B. If zero, the coordinate ID for rigid body A is used, see *DEFINE_COORDINATE_OPTION. For the translational stiffness the local coordinate system must be defined by nodal points, *DEFINE_COORDINATE_NODES, since the first nodal point in each coordinate system is used to track the motion.
JID	Joint ID for the joint reaction forces. If zero, tables can't be used in place of load curves for defining the frictional moments.

**Card 2 of 4 - Required for FLEXION-TORSION stiffness.**

Card 2            1            2            3            4            5            6            7            8

Variable	LCIDAL	LCIDG	LCIDBT	DLCIDAL	DLCIDG	DLCIDBT		
Type	I	I	I	I	I	I		
Default	none	1.0	none	none	1.0	none		

Card 3            1            2            3            4            5            6            7            8

Variable	ESAL	FMAL	ESBT	FMBT				
Type	F	F	F	F				
Default	0.0	0.0	0.0	0.0				

Card 4            1            2            3            4            5            6            7            8

Variable	SAAL	NSABT	PSABT					
Type	F	F	F					
Default	not used	not used	not used					

**VARIABLE****DESCRIPTION**

LCIDAL

Load curve ID for  $\alpha$ -moment versus rotation in radians. See Figure 9.17 where it should be noted that  $0 \leq \alpha \leq \pi$ . If zero, the applied moment is set to zero. See \*DEFINE\_CURVE.

VARIABLE	DESCRIPTION
LCIDG	Load curve ID for $\gamma$ versus a scale factor which scales the bending moment due to the $\alpha$ rotation. This load curve should be defined in the interval $-\pi \leq \gamma \leq \pi$ . If zero the scale factor defaults to 1.0. See *DEFINE_CURVE.
LCIDBT	Load curve ID for $\beta$ -torsion moment versus twist in radians. If zero the applied twist is set to zero. See *DEFINE_CURVE.
DLCIDAL	Load curve ID for $\alpha$ -damping moment versus rate of rotation in radians per unit time. If zero, damping is not considered. See *DEFINE_CURVE.
DLCIDG	Load curve ID for $\gamma$ -damping scale factor versus rate of rotation in radians per unit time. This scale factor scales the $\alpha$ -damping moment. If zero, the scale factor defaults to one. See *DEFINE_CURVE.
DLCIDBT	Load curve ID for $\beta$ -damping torque versus rate of twist. If zero damping is not considered. See *DEFINE_CURVE.
ESAL	Elastic stiffness per unit radian for friction and stop angles for $\alpha$ rotation, see Figure 9.17. If zero, friction and stop angles are inactive for $\alpha$ rotation.
FMAL	Frictional moment limiting value for $\alpha$ rotation. If zero, friction is inactive for $\alpha$ rotation. This option may also be thought of as an elastic-plastic spring. If a negative value is input then the absolute value is taken as the load curve or table ID defining the yield moment versus $\alpha$ rotation, see Figure 9.17. A table permits the moment to also be a function of the joint reaction force and requires the specification of JID on Card 1.
ESBT	Elastic stiffness per unit radian for friction and stop angles for $\beta$ twist, see Figure 9.17. If zero, friction and stop angles are inactive for $\beta$ twist.
FMBT	Frictional moment limiting value for $\beta$ twist. If zero, friction is inactive for $\beta$ twist. This option may also be thought of as an elastic-plastic spring. If a negative value is input then the absolute value is taken as the load curve or table ID defining the yield moment versus $\beta$ rotation, see Figure 9.17. A table permits the moment to also be a function of the joint reaction force and requires the specification of JID on Card 1.
SAAL	Stop angle in degrees for $\alpha$ rotation where $0 \leq \alpha \leq \pi$ . Ignored if zero.
NSABT	Stop angle in degrees for negative $\beta$ rotation. Ignored if zero.

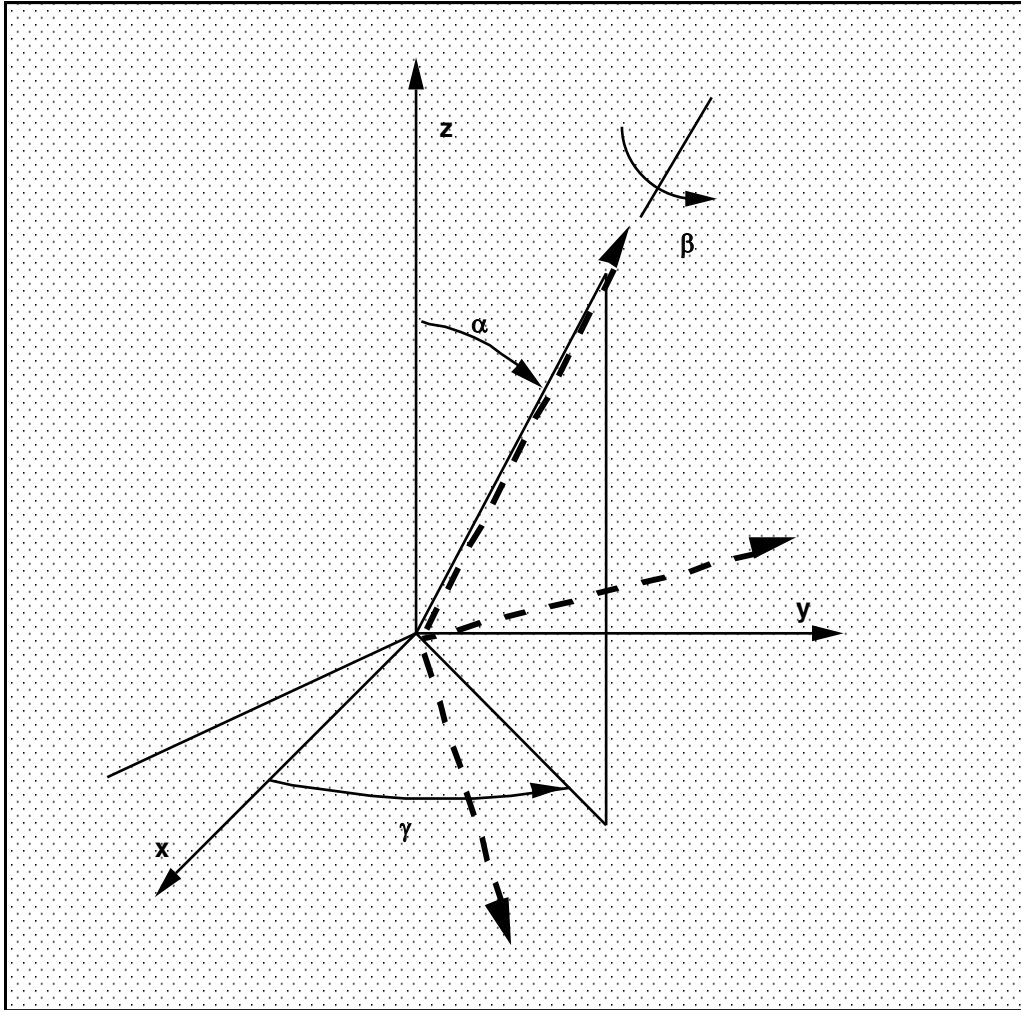
<u>VARIABLE</u>	<u>DESCRIPTION</u>
PSABT	Stop angle in degrees for positive $\beta$ rotation. Ignored if zero.

**Remarks:**

This option simulates a flexion-torsion behavior of a joint in a slightly different fashion than with the generalized joint option.

After the stop angles are reached the torques increase linearly to resist further angular motion using the stiffness values on Card 3. If the stiffness value is too low or zero, the stop will be violated.

The moment resultants generated from the moment versus rotation curve, damping moment versus rate-of-rotation curve, and friction are evaluated independently and are added together.



**Figure 9.17.** Flexion-torsion joint angles. If the initial positions of the local coordinate axes of the two rigid bodies connected by the joint do not coincide, the angles,  $\alpha$  and  $\gamma$ , are initialized and torques will develop instantaneously based on the defined load curves. The angle  $\beta$  is also initialized but no torque will develop about the local axis on which  $\beta$  is measured. Rather,  $\beta$  will be measured relative to the computed offset.

**Card 2-4 - Required for GENERALIZED stiffness.**

Card 2            1            2            3            4            5            6            7            8

Variable	LCIDPH	LCIDT	LCIDPS	DLCIDPH	DLCIDT	DLCIDPS		
Type	I	I	I	I	I	I		
Default	none	none	none	none	none	none		

Card 3            1            2            3            4            5            6            7            8

Variable	ESPH	FMPH	EST	FMT	ESPS	FMPS		
Type	F	F	F	F	F	F		
Default	0.0	0.0	0.0	0.0	0.0	0.0		

Card 4            1            2            3            4            5            6            7            8

Variable	NSAPH	PSAPH	NSAT	PSAT	NSAPS	PSAPS		
Type	F	F	F	F	F	F		
Default	not used	not used	not used	not used	not used	not used		

**VARIABLE****DESCRIPTION**

LCIDPH	Load curve ID for $\phi$ -moment versus rotation in radians. See Figure 9.18. If zero, the applied moment is set to 0.0. See *DEFINE_CURVE.
LCIDT	Load curve ID for $\theta$ -moment versus rotation in radians. If zero, the applied moment is set to 0.0. See *DEFINE_CURVE.
LCIDPS	Load curve ID for $\psi$ -moment versus rotation in radians. If zero, the applied moment is set to 0.0. See *DEFINE_CURVE.

VARIABLE	DESCRIPTION
DLCIDPH	Load curve ID for $\phi$ -damping moment versus rate of rotation in radians per unit time. If zero, damping is not considered. See *DEFINE_CURVE.
DLCIDT	Load curve ID for $\theta$ -damping moment versus rate of rotation in radians per unit time. If zero, damping is not considered. See *DEFINE_CURVE.
DLCIDPS	Load curve ID for $\psi$ -damping torque versus rate of rotation in radians per unit time. If zero, damping is not considered. See *DEFINE_CURVE.
ESPH	Elastic stiffness per unit radian for friction and stop angles for $\phi$ rotation. See Figure 9.19. If zero, friction and stop angles are inactive for $\phi$ rotation.
FMPH	Frictional moment limiting value for $\phi$ rotation. If zero, friction is inactive for $\phi$ rotation. This option may also be thought of as an elastic-plastic spring. If a negative value is input then the absolute value is taken as the load curve or table ID defining the yield moment versus $\phi$ rotation. See Figure 9.19. A table permits the moment to also be a function of the joint reaction force and requires the specification of JID on card 1.
EST	Elastic stiffness per unit radian for friction and stop angles for $\theta$ rotation. See Figure 9.19. If zero, friction and stop angles are inactive for $\theta$ rotation.
FMT	Frictional moment limiting value for $\theta$ rotation. If zero, friction is inactive for $\theta$ rotation. This option may also be thought of as an elastic-plastic spring. If a negative value is input then the absolute value is taken as the load curve or table ID defining the yield moment versus $\theta$ rotation. See Figure 9.19. A table permits the moment to also be a function of the joint reaction force and requires the specification of JID on card 1.
ESPS	Elastic stiffness per unit radian for friction and stop angles for $\psi$ rotation. See Figure 9.19. If zero, friction and stop angles are inactive for $\psi$ rotation.
FMPS	Frictional moment limiting value for $\psi$ rotation. If zero, friction is inactive for $\psi$ rotation. This option may also be thought of as an elastic-plastic spring. If a negative value is input then the absolute value is taken as the load curve or table ID defining the yield moment versus

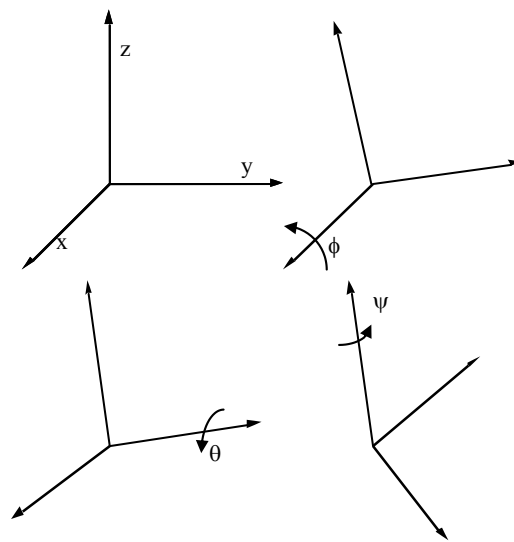
<u>VARIABLE</u>	<u>DESCRIPTION</u>
	$\psi$ rotation. See Figure 9.19. A table permits the moment to also be a function of the joint reaction force and requires the specification of JID on card 1.
NSAPH	Stop angle in degrees for negative $\phi$ rotation. Ignored if zero.
PSAPH	Stop angle in degrees for positive $\phi$ rotation. Ignored if zero.
NSAT	Stop angle in degrees for negative $\theta$ rotation. Ignored if zero.
PSAT	Stop angle in degrees for positive $\theta$ rotation. Ignored if zero.
NSAPS	Stop angle in degrees for negative $\psi$ rotation. Ignored if zero.
PSAPS	Stop angle in degrees for positive $\psi$ rotation. Ignored if zero.

**Remarks:**

After the stop angles are reached the torques increase linearly to resist further angular motion using the stiffness values on Card 3. Reasonable stiffness values have to be chosen. If the stiffness values are too low or zero, the stop will be violated.

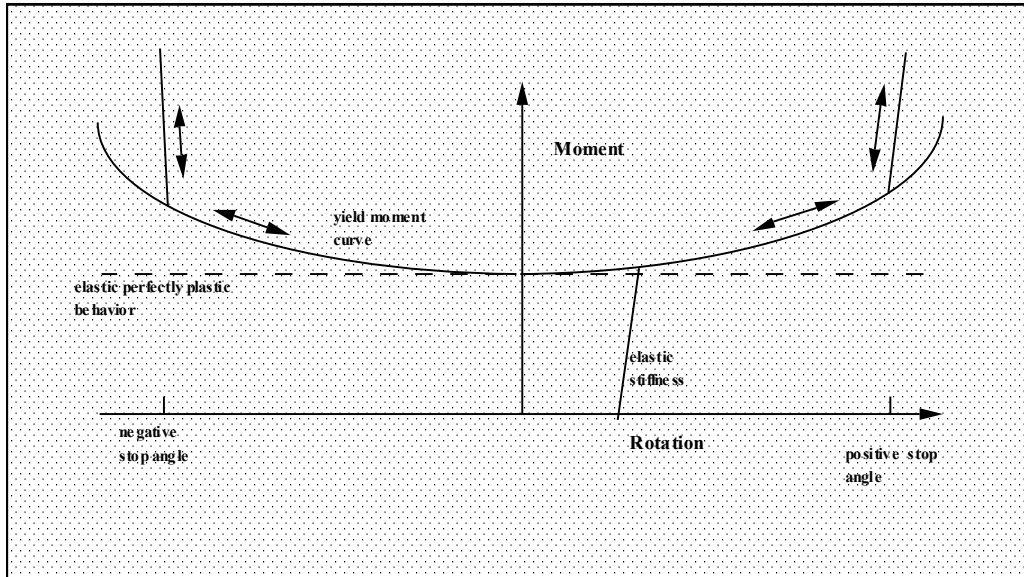
If the initial local coordinate axes do not coincide, the angles,  $\phi$ ,  $\theta$ , and  $\psi$ , will be initialized and torques will develop instantaneously based on the defined moment vs. rotation curves.

There are two methods available to calculate the rotation angles between the coordinate systems. For more information, see the JNTF parameter on \*CONTROL\_RIGID.



**Figure 9.18.** Definition of angles for the generalized joint stiffness.





**Figure 9.19.** Frictional behavior is modeled by a plasticity model. Elastic behavior is obtained once the stop angles are reached. The same elastic stiffness is used to simulate sticking situations.

**Card 2- 4 - Required for TRANSLATIONAL stiffness.**

Card 2            1            2            3            4            5            6            7            8

Variable	LCIDX	LCIDY	LCIDZ	DLCIDX	DLCIDY	DLCIDZ		
Type	I	I	I	I	I	I		
Default	none	none	none	none	none	none		

# \*CONSTRAINED

# \*CONSTRAINED\_JOINT\_STIFFNESS

Card 3            1            2            3            4            5            6            7            8

Variable	ESX	FFX	ESY	FFY	ESZ	FFZ		
Type	F	F	F	F	F	F		
Default	0.0	0.0	0.0	0.0	0.0	0.0		

Card 4            1            2            3            4            5            6            7            8

Variable	NSDX	PSDX	NSDY	PSDY	NSDZ	PSDZ		
Type	F	F	F	F	F	F		
Default	not used	not used	not used	not used	not used	not used		

## VARIABLE

## DESCRIPTION

LCIDX	Load curve ID for x–force versus x-translational relative displacement between the origins of CIDA and CIDB based on the x-direction of CIDB. If zero, the applied force is set to 0.0. See *DEFINE_CURVE. See Figure 9.20.
LCIDY	Load curve ID for y–force versus y-translational relative displacement between the origins of CIDA and CIDB based on the y-direction of CIDB. If zero, the applied force is set to 0.0. See *DEFINE_CURVE.
LCIDZ	Load curve ID for z–force versus z-translational relative displacement between the origins of CIDA and CIDB based on the z-direction of CIDB. If zero, the applied force is set to 0.0. See *DEFINE_CURVE.
DLCIDX	Load curve ID for x–damping force versus rate of x-translational displacement per unit time between the origins of CIDA and CIDB based on the x-direction of CIDB. If zero, damping is not considered. See *DEFINE_CURVE.
DLCIDY	Load curve ID for y–damping force versus rate of y-translational displacement per unit time between the origins of CIDA and CIDB based on the y-direction of CIDB. If zero, damping is not considered.

---

<b>VARIABLE</b>	<b>DESCRIPTION</b>
	See *DEFINE_CURVE.
DLCIDZ	Load curve ID for z-damping force versus rate of z-translational displacement per unit time between the origins of CIDA and CIDB based on the z-direction of CIDB. If zero, damping is not considered. See *DEFINE_CURVE.
ESX	Elastic stiffness for friction and stop displacement for x-translation. If zero, friction and stop angles are inactive for x-translation.
FFX	Frictional force limiting value for x-translation. If zero, friction is inactive for x-translation. This option may also be thought of as an elastic-plastic spring. If a negative value is input then the absolute value is taken as the load curve ID defining the yield force versus x-translation.
ESY	Elastic stiffness for friction and stop displacement for y-translation. If zero, friction and stop angles are inactive for y-translation.
FFY	Frictional force limiting value for y-translation. If zero, friction is inactive for y-translation. This option may also be thought of as an elastic-plastic spring. If a negative value is input then the absolute value is taken as the load curve ID defining the yield force versus y-translation.
ESZ	Elastic stiffness for friction and stop displacement for z-translation. If zero, friction and stop angles are inactive for z-translation..
FMZ	Frictional force limiting value for z-translation. If zero, friction is inactive for z-translation. This option may also be thought of as an elastic-plastic spring. If a negative value is input then the absolute value is taken as the load curve ID defining the yield force versus z-translation.
NSDX	Stop displacement for negative x-translation. Ignored if zero.
PSDX	Stop displacement for positive x-translation. Ignored if zero.
NSDY	Stop displacement for negative y-translation. Ignored if zero.
PSDY	Stop displacement for positive y-translation. Ignored if zero.
NSDZ	Stop displacement for negative z-translation. Ignored if zero.
PSDZ	Stop displacement for positive z-translation. Ignored if zero.





# \*CONSTRAINED

# \*CONSTRAINED\_JOINT\_USER\_FORCE

## \*CONSTRAINED\_JOINT\_USER\_FORCE

Purpose: Define input data for a user subroutine to generate force resultants as a function of time and joint motion.

Card 1            1            2            3            4            5            6            7            8

Variable	FID	JID	NHISV					
Type	I	I	I					
Default	none	none	0					

**Define up to 48 optional user constants for the user subroutine. This input is terminated after 48 constants are defined or when the next “\*” keyword card is encountered.**

Card 2,3,...    1            2            3            4            5            6            7            8

Variable	CONST1	CONST2	CONST3	CONST4	CONST5	CONST6	CONST7	CONST8
Type	F	F	F	F	F	I	I	F
Default	0.0	0.0	0.0	0.0	0.0	0.0	0.0	0.0

### VARIABLE

### DESCRIPTION

FID	Joint user force ID.
JID	Joint ID for which this user force input applies.
NHISV	Number of history variables required for this definition. An array NHISV long is allocated and passed into the user subroutine. This array is updated in the user subroutine.
CONSTn	A constant which is passed into the user subroutine.



# \*CONSTRAINED

# \*CONSTRAINED\_LAGRANGE\_IN\_SOLID

**Card 1 is mandatory for all coupling definitions.**

Card 1            1            2            3            4            5            6            7            8

Variable	SLAVE	MASTER	SSTYP	MSTYP	NQUAD	CTYPE	DIREC	MCoup
Type	I	I	I	I	I	I	I	I
Default	none	none	0	0	0	2	1	0

**Card 2 is mandatory for all coupling definitions.**

Card 2            1            2            3            4            5            6            7            8

Variable	START	END	PFAC	FRIC	FRCMIN	NORM	NORMTYP	DAMP
Type	F	F	F	F	F	I	I	F
Default	0	1.0E10	0.1	0.0	0.5	0	0	0.0

**Card 3 is mandatory for all coupling definitions.**

Card 3            1            2            3            4            5            6            7            8

Variable	CQ	HMIN	HMAX	ILEAK	PLEAK	LCIDPOR	NVENT	IBLOCK
Type	F	F	F	I	F	I	I	I
Default	0.0	none	none	0	0.1	0	0	0



**Optional Card 4a may be defined with or without 4b. It is required for CTYPE 11 & 12. (define THKF if CTYPE=11).**

Card 4a            1            2            3            4            5            6            7            8

Variable	IBOXID	IPENCHK	INTFORC	IALESOF	LAGMUL	PFACMM	THKF	
Type	I	I	I	I	F	I	F	
Default	0	0	0	0	0.0	0	0.0	

**Optional Card 4b is required for CTYPE 11 & 12. If 4b is defined, 4a must be defined before 4b.**

Card 4b            1            2            3            4            5            6            7            8

Variable	A1	B1	A2	B2	A3	B3	GRADVF	POREINI
Type	F	F	F	F	F	F	F	F
Default	0.0	0.0	0.0	0.0	0.0	0.0	0.0	0.0

**Optional 4c card(s) defining venting geometry. It is repeated NVENT times (one line for defining each vent hole). It is defined only if NVENT > 0 in card 3. If either or both 4a and 4b are defined, they are defined before card(s) 4c.**

Card 4c            1            2            3            4            5            6            7            8

Variable	VENTSID	VENTYP	VTCOEF	POPPRES	COEFLC			
Type	I	I	I	F	I			
Default	0	0	0	0.0	0			

<u>VARIABLE</u>	<u>DESCRIPTION</u>
COUPID	Coupling (card) ID number (I10). This ID can be used in a restart input deck to delete or reactivate this coupling action via the *DELETE_FSI card. If not defined, LSDYNA will assign an internal coupling ID based on the order of appearance in the input deck.
TITLE	A description of this coupling definition (A70).
SLAVE	Slave set ID defining a part, part set or segment set ID of the Lagrangian or slave structure (see *PART, *SET_PART or *SET_SEGMENT). See Remark 1.
MASTER	Master set ID defining a part or part set ID of the ALE or master solid elements (see *PART or *SET_PART, and see Remark 1).
SSTYP	Slave set type of "SLAVE" (see Remark 1): EQ.0: part set ID (PSID). EQ.1: part ID (PID). EQ.2: segment set ID (SGSID).
MSTYP	Master set type of "MASTER" (see Remark 1): EQ.0: part set ID (PSID). EQ.1: part ID (PID).
NQUAD	Number of coupling points distributed over each coupled Lagrangian surface segment. EQ.0: NQUAD will be set by default to 2, EQ.n: An nXn coupling points distribution over each Lagrangian segment is defined, EQ.-n: NQUAD is reset to a positive value. Coupling at nodes is obsolete.

VARIABLE	DESCRIPTION
CTYPE	<p>Fluid-Structure coupling method:</p> <p>EQ.1: constrained acceleration.</p> <p>EQ.2: constrained acceleration and velocity (default, see Remark 3).</p> <p>EQ.3: constrained acceleration and velocity, normal direction only.</p> <p>EQ.4: penalty coupling for shell (with or without erosion) and solid elements (without erosion).</p> <p>EQ.5: penalty coupling allowing erosion in the Lagrangian entities (solid elements, see Remark 3).</p> <p>EQ.6: penalty coupling designed for airbag modeling which automatically controls the DIREC parameter internally. It is equivalent to setting {CTYPE=4; DIREC=1} for unfolded region; and {CTYPE=4; DIREC=2}; in folded region. For both cases: {ILEAK=2; FRCMIN=0.3}.</p> <p>EQ.11: coupling designed to couple Lagrangian porous shell to ALE material. When this option is used, THKF, the 7<sup>th</sup> column parameter of optional card 4a and the first 2 parameters of optional card 4b must be defined. See *LOAD_BODY_POROUS and remark 14 below.</p> <p>EQ.12: coupling designed to couple Lagrangian porous solid to ALE material. When this option is used, A<sub>i</sub> &amp; B<sub>i</sub> parameters of optional card 4b must be defined (card 4a must be defined but can be blank). See *LOAD_BODY_POROUS and Remark 14 below</p>
DIREC	<p>Coupling direction (CTYPE 4 and 5, see Remark 4).</p> <p>EQ.1: normal direction, compression and tension (default)</p> <p>EQ.2: normal direction, compression only,</p> <p>EQ.3: all directions.</p>
MCOUP	<p>Multi-material option (CTYPE 4, 5, 6, 11 and 12, see Remark 5).</p> <p>EQ.0: couple with all multi-material groups,</p> <p>EQ.1: couple with material with highest density.</p> <p>EQ.-n: refers to a set ID of an ALE multi-material groups defined in *SET_MULTI-MATERIAL_GROUP card in which its set ID=n.</p>
START	<p>Start time for coupling.</p>
END	<p>End time for coupling.</p>

<b>VARIABLE</b>	<b>DESCRIPTION</b>
PFAC	<p>Penalty factor (CTYPE 4, 5 and 6). PFAC is a scale factor for scaling the estimated stiffness of the interacting (coupling) system. It is used to compute the coupling forces to be distributed on the slave and master parts</p> <p>GT.0.0: Fraction of estimated critical stiffness. LT.0: -n: where n refers to a load curve ID. The curve defines the coupling pressure (y-axis) as a function of the penetration (x-axis) (See Remark 6).</p> <p>For CTYPE=11 or CTYPE=12: Time step factor</p>
FRIC	<p>Coefficient of friction (used with DIREC 2 only).</p>
FRCMIN	<p>Minimum volume fraction of a coupled ALE multi-material group (AMMG) or fluid in a multi-material ALE element to activate coupling. Default value is 0.5. Reducing FRCMIN (typically, between 0.1 and 0.3) would turn on coupling earlier to prevent leakage in hypervelocity impact cases.</p>
NORM	<p>A Lagrangian segment will couple to fluid on only one side of the segment. NORM determines which side. See Remark 7.</p> <p>EQ.0: Couple to fluid (AMMG) on head-side of Lagrangian segment normal vector. EQ.1: Couple to fluid (AMMG) on tail-side of Lagrangian segment normal vector.</p>
NORMTYP	<p>Penalty coupling spring (or force) direction (DIREC 1 and 2):</p> <p>EQ.0: normal vectors are interpolated from nodal normals. (default). EQ.1: normal vectors are interpolated from segment normals. This is sometimes a little more robust for sharp Lagrangian corners, and folds.</p>
DAMP	<p>Damping factor for penalty coupling. This is a coupling-damping scaling factor. Typically it may be between 0 and 1 (see Remark 8).</p>
CQ	<p>Heat transfer coefficient, <math>C_q</math> (see Remark 9).</p>
HMIN	<p>Minimum air gap in heat transfer, <math>h_{\min}</math> (see Remark 9).</p>
HMAX	<p>Maximum air gap in heat transfer, <math>h_{\max}</math>. There is no heat transfer above this value (see Remark 9).</p>

VARIABLE	DESCRIPTION
ILEAK	<p>Coupling leakage control flag (Remark 10):</p> <p>EQ.0: none (default),</p> <p>EQ.1: weak, leakage control is turned off if the penetrating volfrac &gt; FRCMIN+0.1.</p> <p>EQ.2: strong, with improved energy consideration. Leakage control is turned off if the penetrating volfrac &gt; FRCMIN+0.3.</p>
PLEAK	<p>Leakage control penalty factor, <math>0 &lt; \text{PLEAK} &lt; 0.2</math> is recommended. This factor influences the additional coupling force magnitude to prevent leakage. It is conceptually similar to PFAC. Almost always, the default value (0.1) is adequate.</p>
LCIDPOR	<p>If this is a positive integer: A load curve ID (LCID) defining porous flow through coupling segment:</p> <p style="padding-left: 40px;">Abscissa = <math>x = (P_{\text{up}} - P_{\text{down}})</math></p> <p style="padding-left: 40px;">Ordinate = <math>y =</math> relative porous fluid velocity</p> <p>Where <math>P_{\text{up}}</math> and <math>P_{\text{down}}</math> are, respectively, the upstream and downstream pressures across of the porous coupling segment. The relative porous velocity is the ALE fluid velocity relative to the moving Lagrangian segment. This experimental data curve must be provided by the user.</p> <p>If LCIDPOR is a negative integer: The porous flow is controlled by the parameters FLC, FAC, ELA under *MAT_FABRIC card.</p> <p><b>CAUTION:</b></p> <p>The pressure under the FAC load curve is “absolute upstream pressure” (see Remark 11).</p> <p style="padding-left: 40px;">Abscissa = <math>x =</math> absolute upstream pressure</p> <p style="padding-left: 40px;">Ordinate = <math>y =</math> relative porous fluid velocity</p> <p>For CTYPE=11 or CTYPE=12 and POREINI=0.0:</p> <p style="padding-left: 40px;">LT.0: The load curve  LCIDPOR  is a factor versus time of the porous force computed by the Ergun equation (see Remark 14).</p> <p style="padding-left: 40px;">GT.0: The load curve LCIDPOR is a porous force versus time, which replaces the force computed by the Ergun equation (see Remark 14).</p> <p>For CTYPE=11 or CTYPE=12 and POREINI&gt;0.0:</p> <p style="padding-left: 40px;">NE.0: The load curve  LCIDPOR  is a factor versus time of the porous force computed by the Ergun equation (see Remark 14).</p>

<b>VARIABLE</b>	<b>DESCRIPTION</b>
NVENT	The number of vent surface areas to be defined. Each venting flow surface is represented by one or more Lagrangian segments (or surfaces). For airbag application, this may be referred to as “isentropic” venting where the isentropic flow equation is used to compute the mass flow rate across an area given $P_{up}/P_{down}$ ratio. If NVENT > 0, there will be NVENT number of lines required (optional cards 4c). Each line defines the geometrical and flow information for each vent surface: VENTSID, VNTYPE, VTCOEF, POPPRES, COEFLC. The vented mass will simply be deleted from the system and cannot be visualized as in the case of physical venting (see Remark 12).
IBLOCK	Flag (1=ON or 0=OFF) to control the venting (or porous) flow blockage due to Lagrangian contact during ALE computation. The venting definition is defined in this command. However, the venting flow may be defined via either the LCIDPOR parameter in this command or via the *MAT_FABRIC parameters (FLC, FAC, ELA). However, note that FVOPT (blocking) parameter under *MAT_FABRIC applies only to CV computation.
IBOXID	A box ID defining a box region in space in which ALE coupling is activated. At time=0.0, the number of Lagrangian segments inside this box is remembered. In subsequent coupling computation steps, there is no need to search for the Lagrangian segments again.
IPENCHK	Initial penetration check flag (only for CTYPE=4, Remark 13): EQ.0: Do not check for initial penetration. EQ.1: Check and save initial ALE material penetration across a Lagrangian surface ( $d_0$ ), but do not activate coupling at $t=0$ . In subsequent steps ( $t>0$ ) the actual penetration is computed as follows actual penetration = total penetration – initial penetration $d_a = d_T - d_0$
INTFORC	A flag to turn on or off (0=OFF or 1=ON) the output of ALE coupling pressure and forces on the slave Lagrangian segments (or surfaces). Note that the coupling pressures and forces are computed based on the ALE fluid penetrations and coupling stiffness of the system. When (1) INTFORC=1 and (2) a *DATABASE_BINARY_FSIFOR (DBF) card is defined, LS-DYNA writes out the segment coupling pressure and forces to the binary interface force file for contour plotting. This interface force file is activated by executing ls971 as follows (3): <b>ls971 i=inputfilename.k ... h=interfaceforcefilename</b> The time interval between output is defined by “dt” in the DBF card. To plot the binary data in this file: <b>lsprepost interfaceforcefilename</b> .

VARIABLE	DESCRIPTION
IALESOF	<p>An integer flag to turn ON/OFF a supplemental Lagrange multiplier FSI constraint which provides a coupling force in addition to the basic penalty coupling contribution. This is a hybrid coupling method.</p> <p>EQ.0: OFF (default).</p> <p>EQ.1: Turn ON the hybrid Lagrange-multiplier method. LAGMUL multiplier factor is read.</p>
LAGMUL	<p>A Lagrange multiplier factor with a range between 0.0 and 0.05 may be defined. A typical value may be 0.01. This should never be greater than 0.1.</p> <p>EQ.0: OFF (default).</p> <p>GT.0: Turn ON the Lagrange-multiplier method and use LAGMUL as a coefficient for scaling the penalty factor.</p>
PFACMM	<p>Mass-based penalty stiffness factor computational options. This works in conjunction with PFAC=constant (not a load curve). The coupling penalty stiffness (CPS) is computed based on an estimated effective coupling mass.</p> <p>EQ.0: <math>CPS \propto PFAC \cdot \min(m_{slave}, m_{master})</math>, default.</p> <p>EQ.1: <math>CPS \propto PFAC \cdot \max(m_{slave}, m_{master})</math>.</p> <p>EQ.2: <math>CPS \propto PFAC \cdot \sqrt{m_{slave} m_{master}}</math>, geometric-mean of the masses.</p> <p>EQ.3: <math>CPS \propto PFAC \cdot K_{Lagrangian}</math> where K is the bulk modulus of the slave or Lagrangian part</p>
THKF	<p>(For all CTYPE choices except 11) A flag to account for the coupling thickness of the Lagrangian shell (slave) part.</p> <p>LT.0: Use positive value of  THKF  for coupling segment thickness.</p> <p>EQ.0: Do not consider coupling segment thickness.</p> <p>GT.0: Coupling segment thickness scale factor.</p> <p>For CTYPE=11 case (see Remark 14): This thickness is required for volume calculation.</p> <p>GT.0: (Fabric) Thickness scale factor. The base shell thickness is taken from the *PART definition.</p> <p>LT.0: User-defined (Fabric) thickness. The fabric thickness is set to  THKF .</p>

<b>VARIABLE</b>	<b>DESCRIPTION</b>
A1	<p>Viscous coefficient for the porous flow Ergun equation (see Remark 14). For CTYPE=11, <math>A1 = A_n</math> = coefficient for normal-to-segment direction. For CTYPE=12: <math>A1 = A_x</math> = coefficient for global X-direction. If POREINI=0.0 and <math>A1 &lt; 0</math>, the coefficient is time dependent through a load curve id defined by <math> A1 </math> If POREINI&gt;0.0 and <math>A1 &lt; 0</math>, the coefficient is porosity dependent through a load curve id defined by <math> A1 </math>. The porosity is defined by PORE (see POREINI).</p>
B1	<p>Inertial coefficient for the porous flow Ergun equation (see Remark 14). For CTYPE=11, <math>B1 = B_n</math> = coefficient for normal-to-segment direction. For CTYPE=12: <math>B1 = B_x</math> = coefficient for global X-direction. If POREINI=0.0 and <math>B1 &lt; 0</math>, the coefficient is time dependent through a load curve id defined by <math> B1 </math> If POREINI&gt;0.0 and <math>B1 &lt; 0</math>, the coefficient is porosity dependent through a load curve id defined by <math> B1 </math>. The porosity is defined by PORE (see POREINI).</p>
A2	<p>Viscous coefficient for the porous flow Ergun equation (see Remark 14). For CTYPE=12: <math>A2 = A_y</math> = coefficient for global Y-direction. If POREINI=0.0 and <math>A2 &lt; 0</math>, the coefficient is time dependent through a load curve id defined by <math> A1 </math> If POREINI&gt;0.0 and <math>A2 &lt; 0</math>, the coefficient is porosity dependent through a load curve id defined by <math> A2 </math>. The porosity is defined by PORE (see POREINI).</p>
B2	<p>Inertial coefficient for the porous flow Ergun equation (see Remark 14). For CTYPE=12: <math>B2 = B_y</math> = coefficient for global Y-direction. If POREINI=0.0 and <math>B2 &lt; 0</math>, the coefficient is time dependent through a load curve id defined by <math> B2 </math> If POREINI&gt;0.0 and <math>B2 &lt; 0</math>, the coefficient is porosity dependent through a load curve id defined by <math> B2 </math>. The porosity is defined by PORE (see POREINI).</p>
A3	<p>Viscous coefficient for the porous flow Ergun equation (see Remark 14). For CTYPE=12: <math>A3 = A_z</math> = coefficient for global Z-direction. If POREINI=0.0 and <math>A3 &lt; 0</math>, the coefficient is time dependent through a load curve id defined by <math> A3 </math> If POREINI&gt;0.0 and <math>A3 &lt; 0</math>, the coefficient is porosity dependent through a load curve id defined by <math> A3 </math>. The porosity is defined by PORE (see POREINI).</p>



VARIABLE	DESCRIPTION
B3	<p>Inertial coefficient for the porous flow Ergun equation (see Remark 14).            For CTYPE=12: <math>B3 = B_z</math> = coefficient for global Z-direction.            If POREINI=0.0 and <math>B3 &lt; 0</math>, the coefficient is time dependent through a load curve id defined by  B3             If POREINI&gt;0.0 and <math>B3 &lt; 0</math>, the coefficient is porosity dependent through a load curve id defined by  B3 . The porosity is defined by PORE (see POREINI).</p>
DIFVF	<p>For CTYPE=12: coefficient for the diffusion of volume fractions. Forces proportional to the gradient of volume fraction are applied on the fluid and structure: force= - DIFVF * grad(vf) where vf is the volume fraction.</p>
POREINI	<p>For CTYPE=11 or CTYPE=12: Initial volume ratio of pores in an element. The current volume ratio is <math>PORE = POREINI * vol / volini</math>, where vol and volini are the current and initial element volumes respectively.</p>
VENTSID	<p>Set ID of the vent hole shape.</p>
VENTYPT	<p>Vent surface area set ID type:            EQ.0: Part set ID (PSID).            EQ.1: Part ID (PID).            EQ.2: Segment set ID (SGSID).</p>
VTCOEF	<p>Flow coefficient for each vent surface area.</p>
POPPRES	<p>Venting pop pressure limit. If the pressure inside the airbag is lower than this pressure, then nothing is vented. Only when the pressure inside the airbag is greater than POPPRES that venting can begin.</p>
COEFLC	<p>A time-dependent multiplier load curve for correcting the vent flow coefficient, with values ranging from 0.0 to 1.0.</p>

### **Remarks:**

1. In order for a fluid-structure interaction (FSI) to occur, a Lagrangian (structure or slave) mesh must spatially overlap with an ALE (fluid or master) mesh. Each mesh should be defined with independent node IDs. LS-DYNA searches for the spatial intersection of between the Lagrangian and ALE meshes. Where the meshes overlap, there is a possibility that interaction may occur. In general, SLAVE, MASTER, SSTYP and MSTYPE are required definitions for specifying overlapping-domains coupling search.
2. The number of coupling points, NQUADXNQUAD, is distributed over the surface of each Lagrangian segment. Generally, 2 or 3 coupling points per each Eulerian/ALE

element width is adequate. Consequently, the appropriate NQUAD values must be estimated based on the relative resolutions between the Lagrangian and ALE meshes. Consider Case 1 where 1 Lagrangian shell element spans, say, 2 ALE elements. Then NQUAD for each Lagrangian segment should be 4 or 6. Consider Case 2 where 2 or 3 Lagrangian segments span 1 ALE element, then maybe NQUAD=1 would be adequate. If either mesh compresses or expands during the interaction, the number of coupling points per ALE element will also change. The user must account for this and try to maintain at least 2 coupling points per each ALE element side length during the whole process to prevent leakage. Too many coupling points can result in instability, and not enough can result in leakage.

3. CTYPE=2 is sometimes used to couple, via constraint method (energy not conserved), Lagrangian beam nodes to ALE or Lagrangian solids, for example, in the modeling of rebar in concrete, or tire cords in rubber. The slave set is coupled to the master set. Constraint based method does not try to conserve energy and is seldom used. Penalty approach is the current method of choice. For better accuracy, when using the penalty method, it is better to couple to a specific set of AMMGs (set MCOUP to a negative integer, see MCOUP).
4. DIREC=2 may be generally a more stable and robust choice for coupling direction. However a choice of when to activate coupling should be made based on the physics of the problem. DIREC=1 couples under both tension and compression. This is sometimes useful as in the case of suddenly accelerating liquid container. DIREC=3 is rarely applicable to real physics (because it simulates an extremely sticky fluid).
5. When MCOUP is a negative integer, say for example MCOUP= -123, then an ALE multi-material set-ID (AMMSID) of 123 must exist. This is an ID defined by a \*SET\_MULTI-MATERIAL\_GROUP\_LIST card. This generally seems to be a better approach to couple to a specific set of AMMGs, and have a clearly defined fluid interface interacting with a Lagrangian surface. That way, any leakage may be visualized and the penalty force can be computed more precisely.
6. The user can usually start with PFAC=default (0.1). If leakage occurs, leakage control may be turned on, ILEAK=2.

The next thing to try may be using a load curve for PFAC. When PFAC is a negative integer, for example PFAC= -321, then a load curve with LCID=321 must exist via a \*DEFINE\_CURVE card. This choice allows the application of an estimated coupling pressure (y-axis) given a penetration distance (x-axis). The curve consists of {0,0} as the first point and {maximum allowable penetration (MAP), estimated maximum coupling pressure (EMCP)} as a second point. MAP may be a small penetration with respect to the minimum ALE element width (maybe 10% or less). EMCP can be estimated from a maximum fluid pressure observed from a previous run when leakage first occurs. This curve may be scaled to vary the stiffness of the coupling spring. The approach is to gradually increase the coupling stiffness until leakage stops. The best coupling stiffness is one which provides just enough force to prevent leakage and not more.

A 3<sup>rd</sup> approach is to try PFACMM=3 on optional card 4a (with PFAC=constant).

Consider a coupling between a Lagrangian airbag with the ALE inflator gas, a penetration of 1.0E-3 m of the gas across the bag surface will trigger a coupling pressure (say, about 4 atm or 405300 Pascals). The coupling pressure for arbitrary penetration is scaled from this curve.

This example demonstrates the usage of both MCOUP and PFAC when they are negative integers.

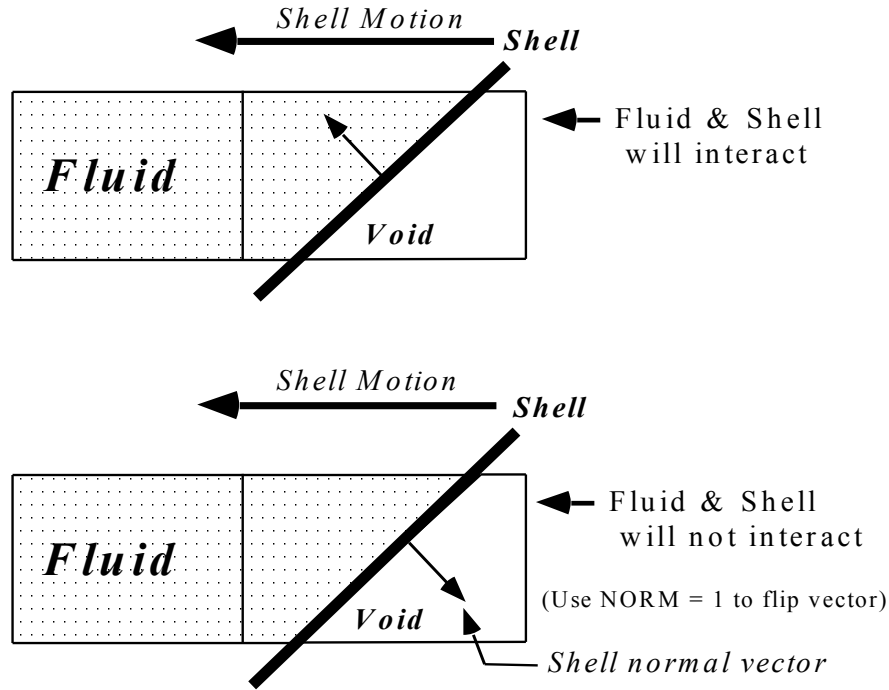
```

$. . . | . . . 1 . . . | . . . 2 . . . | . . . 3 . . . | . . . 4 . . . | . . . 5 . . . | . . . 6 . . . | . . . 7 . . . | . . .
8
$ PID 21 = ALE inflator gas;  PID 22 = air mesh surrounding the airbag
*ALE_MULTI-MATERIAL_GROUP
$   SID      IDTYPE
      21         1
      22         1
$ ALEMMGID = 1 <= PID 21 <== see 1st line of the *ALE_MULTI-MATERIAL_GROUP card.
*SET_MULTI-MATERIAL_GROUP_LIST
$   AMMSID
      123
$ ALEMMGID
      1
$ Lagrangian = slave = PSID 1 contains all airbag parts
*SET_PART
$   SID      DA1      DA2      DA3      DA4
      1         0.         0.         0.         0.
$   PID1      PID2      PID3      PID4      PID5      PID6      PID7      PID8
      3         4         5         6         7         8         9         0
$ Eulerian = master = PSID 11 contains all fluid mesh (geometrical space to
search).
*SET_PART_LIST
      11
      2
*CONSTRAINED_LAGRANGE_IN_SOLID
$   SLAVE      MASTER      SSTYP      MSTYP      NQUAD      CTYPE      DIREC      MCOUP
      1         11         0         0         4         4         2         -123
$   START      END      PFAC      FRIC      FRCMIN      NORM
      0.0       0.0       -321      0.00      0.3         1
$   CQ      HMIN      HMAX      ILEAK      PLEAK      VLK      PLCID
      0         0         0         2         0.10
$ We should couple to only the inflator gas → MCOUP = -123
$ fluid penetration ~ 1 mm <====> Pmax = 405300 pascal ~ 4 atm
*DEFINE_CURVE
      321
              0.0000              0.0
              1.0e-3              405300.0
$. . . | . . . 1 . . . | . . . 2 . . . | . . . 3 . . . | . . . 4 . . . | . . . 5 . . . | . . . 6 . . . | . . . 7 . . . | . . . 8

```

- The normal vectors (NV) of a Lagrangian shell part are defined by the order of the nodes in \*ELEMENT definitions, via the right hand rule, and for a segment set, the order of nodes defined in \*SET\_SEGMENT. Let the side pointed to by NV be “positive”. The penalty method measure penetration as the distance the ALE fluid penetrates from the positive side to the negative side of the Lagrangian segment. Only fluid on the positive side will be “seen” and coupled to. Hence, all normal vectors of the Lagrangian segments should point uniformly toward the ALE fluid(s), AMMGs, to be coupled to. If

NV point uniformly away from the fluid, coupling is not activated. In this case, coupling can be activated by setting NORM=1. Sometimes a shell part or mesh is generated such that its normal vectors do not point uniformly in a consistent direction (all toward the inside or outside of a container, etc.) The user should always check for the normal vectors of any Lagrangian shell part interacting with any fluid. The NORM parameter may be used to flip the normal direction of all the segments included in the Lagrangian slave set.



8. The user-input coupling-damping factor (DAMP) is used to scale down the critical-damping force ( $\sim$  damper constant\*velocity). For a mass-to-rigid-wall system connected by a parallel-spring-damper connector, we can obtain solution for a critically-damped case. DAMP is a factor for scaling down the amount of damping, with DAMP=1 being a critically-damped case.
9. The method used is similar to that done by \*CONTACT\_...\_THERMAL\_... card, except radiation heat transfer is not considered. A gap (1) is assumed to exist between the 2 materials undergoing heat transfer (one is Lagrangian and the other ALE). The convection heat transfer in the gap is assumed to approach simple conduction across the medium in the gap.

$$q = \kappa \frac{dT}{dx} \sim h\Delta T \Rightarrow$$

$$h \sim \frac{\kappa}{l}$$

The heat flux is typically defined as an energy transfer rate per unit area,  $q \sim \frac{[J/s]}{m^2}$ .  $\kappa$  is the thermal conductivity of the material in the gap,  $h$ , the equivalent convection heat

transfer coefficient, and  $\Delta T$ , the temperature difference between the master and slave sides. There are 3 possible scenarios:

(a)  $l > l_{\max} \rightarrow$  No heat transfer.

(b)  $l_{\min} \leq l \leq l_{\max} \rightarrow h \sim \frac{\kappa}{\max(l_{\min}, l)}$ .

(c)  $l < l_{\min} \rightarrow h \sim \frac{\kappa}{l_{\min}}$ .

**CQ** ( $\kappa$ ), **HMIN** ( $l_{\min}$ ), **HMAX** ( $l_{\max}$ ) are defined for this heat transfer estimation.

10. In general, a coupling force stopping “fluid” leakage across a Lagrangian surface should come predominantly from the (penalty) coupling force. Leakage control force should be of secondary effect and should not be bigger than that from the main penalty coupling action. \*DATABASE\_FSI command output (dbfsi) allows for the monitoring of both the coupling forces and the leakage control force contribution. It may be used as a debugging or fine-tuning tool for coupling design. ILEAK=2 has a slightly more accurate energy accounting algorithm, thus is better for airbag applications. Leakage control should only be turned on when coupling to a specific AMMG (MCOUP as a negative integer) with its fluid interface clearly defined and tracked via the \*ALE\_MULTI-MATERIAL\_GROUP card.
11. There are currently 2 methods to model porous flow across a Lagrangian shell structure. Both methods involve defining an empirical data curve of relative porous gas velocity as a function of system pressure. However the pressure definitions are slightly different depending on the choice of parameter defined:
  - a) Via LCIDPOR parameter under \*CONSTRAINED\_LAGRANGE\_IN\_SOLID (CLIS). If this option is used the data curve contains ( $P_{\text{upstream}} - P_{\text{downstream}}$ ) in the x-axis of the curve.
  - b) Via \*MAT\_FABRIC’s FLC, FAC, ELA parameters. If LCIDPOR is negative, and FAC defines a load curve, then this data curve contains absolute upstream pressure (not pressure difference) in the x-axis.

When \*AIRBAG\_ALE is used, it assumes that absolute upstream P is given in the curve defined by FAC under \*MAT\_FABRIC. During CV phase it uses that. In ALE phase, LS-DYNA automatically subtracts 1 atmospheric pressure from the given pressure in the FAC curve. Thus giving it a gauge pressure for the porous coupling calculation. The amount of accumulated mass flowing across a porous Lagrangian surface may be tracked via the \*DATABASE\_FSI card (“pleak” parameter in the “dbfsi” ASCII output file).

12. There are 2 methods to model (airbag) venting. The accumulated mass output of both may be tracked via the \*DATABASE\_FSI card (“pleak” parameter in the “dbfsi” ASCII output file).

- a) In isentropic venting, (define NVENT on card 3) the flow crossing the vent hole surface is estimated from isentropic equation. All airbag shell normal vectors should point uniformly in the same direction (typically, inward). The shell elements for the vent holes, included in the Lagrangian coupling set, should also point in the same direction as the airbag (i.e., inward).
- b) In physical venting, there can be either physical holes in the Lagrangian structure (airbag), or shell parts covering the holes would have their normal vectors pointing outward. Either way, there is no coupling force to stop fluid leakage. It is recommended that \*ALE\_FSI\_SWITCH\_MMG\_ID (AFSM) be used to switch the AMMG ID of the vented gas so that the vented gas outside the bag does not cause leakage (when the same AMMG is present on both sides of the same Lagrangian shell surface, penalty coupling can break down). The shell parts representing the vent holes may be either (i) excluded from the Lagrangian coupling set, or (ii) if included, they should have their normals pointing in opposite direction with respect to the rest of the airbag (typically outward since the rest of the airbag have their normals pointing inward).
13. Typically, penetration check (IPENCHK) should only be used if there is high coupling force applied at t=0. For example, consider a Lagrangian container, filled with non-gaseous fluid (i.e. ALE liquid or solid) via the \*INITIAL\_VOLUME\_FRACTON\_GEOMETRY command. Sometimes due to mesh resolution or complex container geometry, there is initial penetration of the fluid across the container surface. This can give rise to a sharp and immediate coupling force on the fluid at t=0. Turning on IPENCHK may help eliminate this spike in coupling force.
14. For shell, CTYPE=11, the Ergun-type empirical porous flow equation is applied to the normal flow direction across the porous surface. The pressure gradient along the segment normal direction is

$$\frac{dP}{dx_n} = A_n(\varepsilon, \mu)V_n + B_n(\varepsilon, \rho)|V_n|V_n$$

where the subscript “n” refers to the direction normal to the porous Lagrangian shell surface.

$V_n$  is the relative normal-to-porous-shell-surface fluid velocity component.

$A_n(\varepsilon, \mu) = A_1(\varepsilon, \mu)$  is a viscous coefficient of the Ergun-type porous flow equation.

As applied here it should contain the fluid dynamic viscosity ( $\mu$ ) and shell porosity ( $\varepsilon$ ) information.

$B_n(\varepsilon, \rho) = B_1(\varepsilon, \rho)$  is an inertial coefficient of the Ergun-type porous flow equation.

As applied here it should contain the fluid density ( $\rho$ ) and shell porosity ( $\varepsilon$ ) information.

The force increment applied per segment is

$$F_n = \frac{dp}{dx_n} \cdot t \times S \quad \text{where}$$

S is the segment surface area.

t is the shell thickness (THKF).

A1 (  $A_1(\varepsilon, \mu)$  ), B1 (  $B_1(\varepsilon, \mu)$  ) and THKF (t) are required input for porous shell coupling.

For porous solid, CTYPE=12, the pressure gradient along each global direction (i) can be computed similarly.

$$\frac{dP}{dx_i} = A_1(\varepsilon, \mu)V_i + B_1(\varepsilon, \rho)|V_i|V_i$$

$$i = 1, 2, 3$$

$V_i$  is the relative fluid velocity component through the porous solid in the 3 global directions.

$A_1(\varepsilon, \mu)$  is a viscous coefficient of the Ergun-type porous flow equation in the  $i^{\text{th}}$  direction. As applied here it should contain the fluid dynamic viscosity ( $\mu$ ) and shell porosity ( $\varepsilon$ ) information.

$B_1(\varepsilon, \rho)$  is an inertial coefficient of the Ergun-type porous flow equation in the  $i^{\text{th}}$  direction. As applied here it should contain the fluid density ( $\rho$ ) and solid porosity ( $\varepsilon$ ) information.

$A_i$  (  $A_1(\varepsilon, \mu)$  ),  $B_i$  (  $B_1(\varepsilon, \mu)$  ) are required input for porous solid coupling.

See also \*LOAD\_BODY\_POROUS.

15. Due to the complexity of this card, some comments on simple, efficient and robust coupling approach are given here. These are not rigid guidelines, but simply some experience-based observations.

The term “fluid”, in the Fluid-Structure Interaction (FSI), refers to materials with ALE element formulation, not indicating the phase (solid, liquid or gas) of those materials. In fact, solid, liquid and gas can all be modeled by the ALE formulation. The term “structure” refers to materials with Lagrangian element formulation.

In general, penalty coupling (CTYPE 4 & 5) is recommended, and MCOUP=negative integer is a better choice to define a specific ALE multi-material group (AMMG) to be

coupled to the Lagrangian surface. At the minimum, all parameters on card 1 are to be specified, and the default values for most are good starting choices (except MCOUP).

If there is leakage, PFAC, FRCMIN, NORMTYPE and ILEAK are the 4 parameters that can be adjusted.

For hard structure (steel) and very compressible fluid (air), PFAC may be set to 0.1 (or higher). PFAC=constant value.

Next, keeping PFAC=constant and set PFACMM=3 (optional card 4a). This option scales the penalty factor by the bulk modulus of the Lagrangian structure. This new approach has also shown to be effective for some airbag application.

The next approach may be switching from constant PFAC to a load curve approach (i.e. PFAC=load curve, and PFACMM=0). By looking at the pressure in the system near leakage original location, we can get a feel for the pressure required to stop it.

If leakage persists after some iterations on the coupling force controls, one can subsequently try to set ILEAK=2 in combination with the other controls to prevent leakage.

If the modifications fail to stop the leakage, maybe the meshes have to be redesigned to allow better interactions between the Lagrangian and Ale materials.

In the example below, the underlined parameters are usually defined parameters. A full card definition is shown for reference.

```

$. . . | . . . 1 . . . | . . . 2 . . . | . . . 3 . . . | . . . 4 . . . | . . . 5 . . . | . . . 6 . . . | . . . 7 . . . | . . . 8
*CONSTRAINED_LAGRANGE_IN_SOLID
$  SLAVE    MASTER    SSTYP    MSTYP    NQUAD    CTYPE    DIREC    MCOUP
      1          11          0          0          4          4          2          -123
$  START    END        PFAC    FRIC    FRCMIN    NORM    NORMTYPE    DAMP
      0.0      0.0      0.1      0.00     0.3        0        0          0.0
$  CQ      HMIN    HMAX    ILEAK    PLEAK    LCIDPOR    NVENT    IBLOCK
      0        0        0        0        0.0       0        0          0
$4A IBOXID IPENCHK INTFORC IALESOF LAGMUL    PFACMM    THKF
      0        0        0        0        0        0        0
$4B  A1    B1    A2    B2    A3    B3
$  0.0    0.0    0.0    0.0    0.0    0.0
$4C VNTSID VENTYPE VENTCOEF POPPRES COEFLCID (STYPE:0=PSID;1=PID;2=SGSID)
$  0      0      0      0.0    0
$. . . | . . . 1 . . . | . . . 2 . . . | . . . 3 . . . | . . . 4 . . . | . . . 5 . . . | . . . 6 . . . | . . . 7 . . . | . . . 8

```



**\*CONSTRAINED\_LINEAR\_GLOBAL**

Purpose: Define linear constraint equations between displacements and rotations, which can be defined in global coordinate systems. For a newer and for a more general constraint see \*CONSTRAINED\_INTERPOLATION

Card 1            1            2            3            4            5            6            7            8

Variable	LCID								
Type	I								
Default	none								

**Card 2 - Define one card for each constrained degree-of-freedom. Input is terminated when a "\*" card is found.**

Card 2            1            2            3            4            5            6            7            8

Variable	NID	DOF	COEF						
Type	I	I	I						
Default	none	0	0						
Remark	1								

<u>VARIABLE</u>	<u>DESCRIPTION</u>
LCID	Linear constraint definition ID. This ID can be used to identify a set to which this constraint is a member.
NID	Node ID

VARIABLE	DESCRIPTION
DOF	Degree of freedom in the global coordinate system; EQ.1: displacement along global x-direction EQ.2: displacement along global y-direction EQ.3: displacement along global z-direction EQ.4: global rotation about global x-axis EQ.5: global rotation about global y-axis EQ.6: global rotation about global z-axis
COEF	Nonzero coefficient, $C_k$

**Remarks:**

Nodes of a nodal constraint equation cannot be members of another constraint equation or constraint set that constrain the same degrees-of-freedom, a tied interface, or a rigid body; i.e. nodes cannot be subjected to multiple, independent, and possibly conflicting constraints. Also care must be taken to ensure that single point constraints applied to nodes in a constraint equation do not conflict with the constraint sets constrained degrees-of-freedom.

In this section linear constraint equations of the form:

$$\sum_{k=1}^n C_k u_k = C_0$$

can be defined, where  $u_k$  are the displacements and  $C_k$  are user defined coefficients. Unless LS-DYNA is initialized by linking to an implicit code to satisfy this equation at the beginning of the calculation, the constant  $C_0$  is assumed to be zero. The first constrained degree-of-freedom is eliminated from the equations-of-motion:

$$u_1 = C_0 - \sum_{k=2}^n \frac{C_k}{C_1} u_k$$

Its velocities and accelerations are given by

$$\dot{u}_1 = - \sum_{k=2}^n \frac{C_k}{C_1} \dot{u}_k$$

$$\ddot{u}_1 = - \sum_{k=2}^n \frac{C_k}{C_1} \ddot{u}_k,$$

respectively. In the implementation a transformation matrix,  $\underline{L}$ , is constructed relating the unconstrained,  $\underline{u}$ , and constrained,  $\underline{u}_c$ , degrees-of-freedom. The constrained accelerations used in the above equation are given by:

$$\ddot{\underline{u}}_c = [\underline{L}^t \underline{M} \underline{L}]^{-1} \underline{L}^t \underline{F}$$

where  $M$  is the Diagonal lumped mass matrix and  $F$  is the right hand side force vector. This requires the inversion of the condensed mass matrix which is equal in size to the number of constrained degrees-of-freedom minus one.

```

$$$$$$$$$$$$$$$$$$$$$$$$$$$$$$$$$$$$$$$$$$$$$$$$$$$$$$$$$$$$$$$$$$$$$$$$$$$$$$$$
$
$$$ *CONSTRAINED_LINEAR_GLOBAL
$
$$$$$$$$$$$$$$$$$$$$$$$$$$$$$$$$$$$$$$$$$$$$$$$$$$$$$$$$$$$$$$$$$$$$$$$$$$$$$$$$
$
$ Constrain nodes 40 and 42 to move identically in the z-direction.
$
$ When the linear constraint equation is applied, it goes like this:
$
$      0 = C40uz40 + C42uz42
$
$      = uz40 - uz42
$
$      uz40 = uz42
$
$ where,
$      C40 = 1.00 coefficient for node 40
$      C42 = -1.00 coefficient for node 42
$      uz40 = displacement of node 40 in z-direction
$      uz42 = displacement of node 42 in z-direction
$
$
*CONSTRAINED_LINEAR
$
$.>...1.>...2.>...3.>...4.>...5.>...6.>...7.>...8
$
$      i
$      id
$      2
$
$      nid      dof      coef
$      40       3       1.00
$      42       3      -1.00
$
$
$$$$$$$$$$$$$$$$$$$$$$$$$$$$$$$$$$$$$$$$$$$$$$$$$$$$$$$$$$$$$$$$$$$$$$$$$$$$$$$$
$

```

# \*CONSTRAINED

# \*CONSTRAINED\_LINEAR\_LOCAL

## \*CONSTRAINED\_LINEAR\_LOCAL

Purpose: Define linear constraint equations between displacements and rotations, which can be defined in a local coordinate system. Each node may have a unique coordinate ID.

Card 1            1            2            3            4            5            6            7            8

Variable	LCID							
Type	I							
Default	none							

**Card 2 - Define one card for each constrained degree-of-freedom. Input is terminated when a "\*" card is found.**

Card 2            1            2            3            4            5            6            7            8

Variable	NID	DOF	CID	COEF				
Type	I	I	I	I				
Default	none	0	0	0				
Remark	1							

### VARIABLE

### DESCRIPTION

LCID            LCID for linear constraint definition. This ID can be used to identify a set to which this constraint is a member.

NID            Node ID

VARIABLE	DESCRIPTION
DOF	Degree of freedom in the local coordinate system; EQ.1: displacement along local x-direction EQ.2: displacement along local y-direction EQ.3: displacement along local z-direction EQ.4: local rotation about local x-axis EQ.5: local rotation about local y-axis EQ.6: local rotation about local z-axis
CID	Local coordinate system ID number. If the number is zero, the global coordinate system is used.
COEF	Nonzero coefficient, $C_k$

**Remarks:**

In this section linear constraint equations of the form:

$$\sum_{k=1}^n C_k u_k^L = C_0$$

can be defined, where  $u_k^L$  are the displacements in the local coordinate systems and  $C_k$  are user defined coefficients. Unless LS-DYNA is initialized by linking to an implicit code to satisfy this equation at the beginning of the calculation, the constant  $C_0$  is assumed to be zero. The first constrained degree-of-freedom is eliminated from the equations-of-motion:

$$u_1^L = C_0 - \sum_{k=2}^n \frac{C_k}{C_1} u_k^L$$

Its velocities and accelerations are given by

$$\dot{u}_1^L = - \sum_{k=2}^n \frac{C_k}{C_1} \dot{u}_k^L$$

$$\ddot{u}_1^L = - \sum_{k=2}^n \frac{C_k}{C_1} \ddot{u}_k^L$$

respectively. The local displacements are calculated every time step using the local coordinate systems defined by the user. More than one degree of freedom for a node can be constrained by specifying a card for each degree of freedom.

**Nodes of a nodal constraint equation cannot be members of another constraint equation or constraint set that constrain the same degrees-of-freedom, a tied interface, or a rigid body; i.e. nodes cannot be subjected to multiple, independent, and possibly conflicting**

**constraints. Also care must be taken to ensure that single point constraints applied to nodes in a constraint equation do not conflict with the constraint sets constrained degrees-of-freedom.**

**\*CONSTRAINED\_LOCAL**

Purpose: Define a boundary constraint in a local coordinate system.

Card            1            2            3            4            5            6            7            8

Variable	TC	RC	CIR	X	Y	Z	CID	
Type	1	1	1	F	F	F	1	
Default	0	0	0	0	0	0	none	

<u>VARIABLE</u>	<u>DESCRIPTION</u>
TC	Translational Constraint: EQ.1: constrained x translation, EQ.2: constrained y translation, EQ.3: constrained z translation, EQ.4: constrained x and y translations, EQ.5: constrained y and z translations, EQ.6: constrained x and z translations, EQ.7: constrained x, y, and translations.
RC	Rotational Constraint: EQ.1: constrained x-rotation, EQ.2: constrained y-rotation, EQ.3: constrained z-rotation, EQ.4: constrained x and y rotations, EQ.5: constrained y and z rotations, EQ.6: constrained z and x rotations, EQ.7: constrained x, y, and z rotations.
DIR	Direction of normal EQ.1: local x, EQ.2: local y, EQ.3: local z.
X	x-offset coordinate
Y	y-offset coordinate
Z	z-offset coordinate

<u>VARIABLE</u>	<u>DESCRIPTION</u>
CID	Coordinate ID defining the orientation of the wall.

**Remarks:**

Nodes within a mesh-size-dependent tolerance are constrained on a local plane. This option is recommended for use with r-method adaptive remeshing where nodal constraints are lost during the remeshing phase.



**\*CONSTRAINED\_NODAL\_RIGID\_BODY\_{OPTION}\_{OPTION}\_{OPTION}**

Available options include:

&lt;BLANK&gt;

**SPC****INERTIA****TITLE**

If the center of mass is constrained use the **SPC** option. If the inertial properties are defined rather than computed use the **INERTIA** option. A description for the nodal rigid body can be defined with the **TITLE** option.

Purpose: Define a nodal rigid body. This is a rigid body which consists of the defined nodes. If the **INERTIA** option is not used, then the inertia tensor is computed from the nodal masses. Arbitrary motion of this rigid body is allowed. If the **INERTIA** option is used, constant translational and rotational velocities can be defined in a global or local coordinate system.

The first node in the nodal rigid body definition is treated as the master for the case where **DRFLAG** and **RRFLAG** are nonzero. The first node always has six degrees-of-freedom. The release conditions applied in the global system are sometimes convenient in small displacement linear analysis, but, otherwise, are not recommended. It is strongly recommended, especially for implicit calculations, that release conditions are only used for a two noded nodal rigid body.

**Card Format:**

Card 1 is required.

Cards 2 - 4 are required for the **INERTIA** option.Card 5 is required if a local coordinate system is used to specify the inertia tensor when the **INERTIA** option is used.**Remarks:**

1. Unlike the **\*CONSTRAINED\_NODE\_SET** which permits only constraints on translational motion, here the equations of rigid body dynamics are used to update the motion of the nodes and therefore rotations of the nodal sets are admissible. Mass properties are determined from the nodal masses and coordinates. Inertial properties are defined if and only if the **INERTIA** option is specified.

# \*CONSTRAINED

# \*CONSTRAINED\_NODAL\_RIGID\_BODY

The following card is read if and only if the TITLE option is specified.

Optional 1

Variable	TITLE
Type	A80

Card 1 1 2 3 4 5 6 7 8

Variable	PID	CID	NSID	PNODE	IPRT	DRFLAG	RRFLAG	
Type	I	I	I	I	I	I	I	
Default	none	none	none	0	0	0	0	

Define if and only if SPC is specified in the keyword.

Card 2 1 2 3 4 5 6 7 8

Variable	CMO	CON1	CON2					
Type	F	F	F					
Default	0	0	0					

## VARIABLE

## DESCRIPTION

PID	Part ID of the nodal rigid body.
CID	Optional coordinate system ID for the rigid body local system, see *DEFINE_COORDINATE_OPTION. Output of the rigid body data and the degree-of- freedom releases are done in this local system. This local system rotates with the rigid body.
NSID	Nodal set ID, see *SET_NODE_OPTION. This nodal set defines the rigid body. If NSID=0, then NSID=PID, i.e., the node set ID and the part ID are assumed to be identical.

<b>VARIABLE</b>	<b>DESCRIPTION</b>
PNODE	An optional, possibly massless, nodal point located at the mass center of the nodal rigid body. The initial nodal coordinates will be reset if necessary to ensure that they lie at the mass center. In the output files, the coordinates, accelerations, velocities, and displacements of this node will correspond to the mass center of the nodal rigid body. If CID is defined, the velocities and accelerations of PNODE will be output in the local system in the D3PLOT and D3THDT files unless PNODE is specified as a negative number in which case the global system is used.
IPRT	Print flag. For nodal rigid bodies the following values apply: EQ.1: write data into RBDOUT EQ.2: do not write data into RBDOUT Printing is suppressed for two noded rigid bodies unless IPRT is set to unity. This is to avoid excessively large RBDOUT files when many, two-noded welds are used.
DRFLAG	Displacement release flag for all nodes except the first node in the definition. EQ.-7: release x, y, and z displacement in global system EQ.-6: release z and x displacement in global system EQ.-5: release y and z displacement in global system EQ.-4: release x and y displacement in global system EQ.-3: release z displacement in global system EQ.-2: release y displacement in global system EQ.-1: release x displacement in global system EQ. 0: off for rigid body behavior EQ. 1: release x displacement in rigid body local system EQ. 2: release y displacement in rigid body local system EQ. 3: release z displacement in rigid body local system EQ. 4: release x and y displacement in rigid body local system EQ. 5: release y and z displacement in rigid body local system EQ. 6: release z and x displacement in rigid body local system EQ. 7: release x, y, and z displacement in rigid body local system

<u>VARIABLE</u>	<u>DESCRIPTION</u>
RRFLAG	Rotation release flag for all nodes except the first node in the definition. EQ.-7: release x, y, and z rotations in global system EQ.-6: release z and x rotations in global system EQ.-5: release y and z rotations in global system EQ.-4: release x and y rotations in global system EQ.-3: release z rotation in global system EQ.-2: release y rotation in global system EQ.-1: release x rotation in global system EQ. 0: off for rigid body behavior EQ. 1: release x rotation in rigid body local system EQ. 2: release y rotation in rigid body local system EQ. 3: release z rotation in rigid body local system EQ. 4: release x and y rotations in rigid body local system EQ. 5: release y and z rotations in rigid body local system EQ. 6: release z and x rotations in rigid body local system EQ. 7: release x, y, and z rotations in rigid body local system
CMO	Center of mass constraint option, CMO: EQ.+1.0: constraints applied in global directions, EQ.0.0: no constraints, EQ.-1.0: constraints applied in local directions (SPC constraint).
CON1	First constraint parameter: <u>If CMO=+1.0, then specify global translational constraint:</u> EQ.0: no constraints, EQ.1: constrained x displacement, EQ.2: constrained y displacement, EQ.3: constrained z displacement, EQ.4: constrained x and y displacements, EQ.5: constrained y and z displacements, EQ.6: constrained z and x displacements, EQ.7: constrained x, y, and z displacements. <u>If CMO=-1.0, then specify local coordinate system ID.</u> See *DEFINE_ COORDINATE_OPTION: This coordinate system is fixed in time

VARIABLE	DESCRIPTION
CON2	<p>Second constraint parameter:                      If CMO=+1.0, then specify global rotational constraint:                      EQ.0: no constraints,                      EQ.1: constrained x rotation,                      EQ.2: constrained y rotation,                      EQ.3: constrained z rotation,                      EQ.4: constrained x and y rotations,                      EQ.5: constrained y and z rotations,                      EQ.6: constrained z and x rotations,                      EQ.7: constrained x, y, and z rotations.</p> <p>If CMO=-1.0, then specify local (SPC) constraint:                      EQ.000000 no constraint,                      EQ.100000 constrained x translation,                      EQ.010000 constrained y translation,                      EQ.001000 constrained z translation,                      EQ.000100 constrained x rotation,                      EQ.000010 constrained y rotation,                      EQ.000001 constrained z rotation.</p> <p>Any combination of local constraints can be achieved by adding the number 1 into the corresponding column.</p>

**Required for the INERTIA option.**

Card 2	1	2	3	4	5	6	7	8
Variable	XC	YC	ZC	TM	IRCS	NODEID		
Type	F	F	F	F	I	I		
Default	0	0	0	0	0	0		

VARIABLE	DESCRIPTION
XC	x-coordinate of center of mass. If nodal point, NODEID, is defined, XC, YC, and ZC are ignored and the coordinates of the nodal point, NODEID, are taken as the center of mass.
YC	y-coordinate of center of mass

<u>VARIABLE</u>	<u>DESCRIPTION</u>
ZC	z-coordinate of center of mass
TM	Translational mass
IRCS	Flag for inertia tensor reference coordinate system: EQ.0: global inertia tensor, EQ.1: local inertia tensor is given in a system defined by the orientation vectors as given below.
NODEID	Optional nodal point defining the CG of the rigid body. If this node is not a member of the set NSID above, its motion will not be updated to correspond with the nodal rigid body after the calculation begins. PNODE and NODEID can be identical if and only if PNODE physically lies at the mass center at time zero.

**Required for the INERTIA option.**

Card 3            1            2            3            4            5            6            7            8

Variable	IXX	IXY	IXZ	IYY	IYZ	IZZ		
Type	F	F	F	F	F	F		
Default	none	0	0	none	0	0		

<u>VARIABLE</u>	<u>DESCRIPTION</u>
IXX	$I_{xx}$ , xx component of inertia tensor
IXY	$I_{xy}$ , xy component of inertia tensor
IXZ	$I_{xz}$ , xz component of inertia tensor
IYY	$I_{yy}$ , yy component of inertia tensor
IYZ	$I_{yz}$ , yz component of inertia tensor
IZZ	$I_{zz}$ , zz component of inertia tensor

**Required for the INERTIA option.**

Card 4            1            2            3            4            5            6            7            8

Variable	VTX	VTY	VTZ	VRX	VRY	VRZ		
Type	F	F	F	F	F	F		
Default	0	0	0	0	0	0		

**VARIABLE****DESCRIPTION**

VTX	x-rigid body initial translational velocity in global coordinate system.
VTY	y-rigid body initial translational velocity in global coordinate system.
VTZ	z-rigid body initial translational velocity in global coordinate system.
VRX	x-rigid body initial rotational velocity in global coordinate system.
VRY	y-rigid body initial rotational velocity in global coordinate system.
VRZ	z-rigid body initial rotational velocity in global coordinate system.

**Remarks:**

The velocities defined above can be overwritten by the \*INITIAL\_VELOCITY card.

**Optional card required for IRCS=1. Define two local vectors or a local coordinate system ID.**

Card 5            1            2            3            4            5            6            7            8

Variable	XL	YL	ZL	XLIP	YLIP	ZLIP	CID2	
Type	F	F	F	F	F	F	I	
Default	none	none	none	none	none	none	none	







# \*CONSTRAINED

# \*CONSTRAINED\_NODE\_INTERPOLATION

## \*CONSTRAINED\_NODE\_INTERPOLATION

Purpose: Define constrained nodes for the use of \*ELEMENT\_INTERPOLATION\_SHELL and \*ELEMENT\_INTERPOLATION\_SOLID to model contact and to visualize the results of generalized elements (see \*ELEMENT\_GENERALIZED\_SHELL/SOLID). The displacements of these nodes are dependent of their corresponding master nodes.

### Card Format (8I10)

Card 1            1            2            3            4            5            6            7            8

Variable	NID	NUMMN						
Type	I	I						
Default	none	none						

**Define for every corresponding master node (NUMMN) of the master element (\*ELEMENT\_GENERALIZED\_SHELL/SOLID) the appropriate weighting factor (up to four weights per card). Define as many cards as needed**

Cards            1            2            3            4            5            6            7            8

Variable	MN1	W1	MN2	W2	MN3	W3	MN4	W4
Type	I	F	I	F	I	F	I	F
Default	none	none	none	none	none	none	none	none

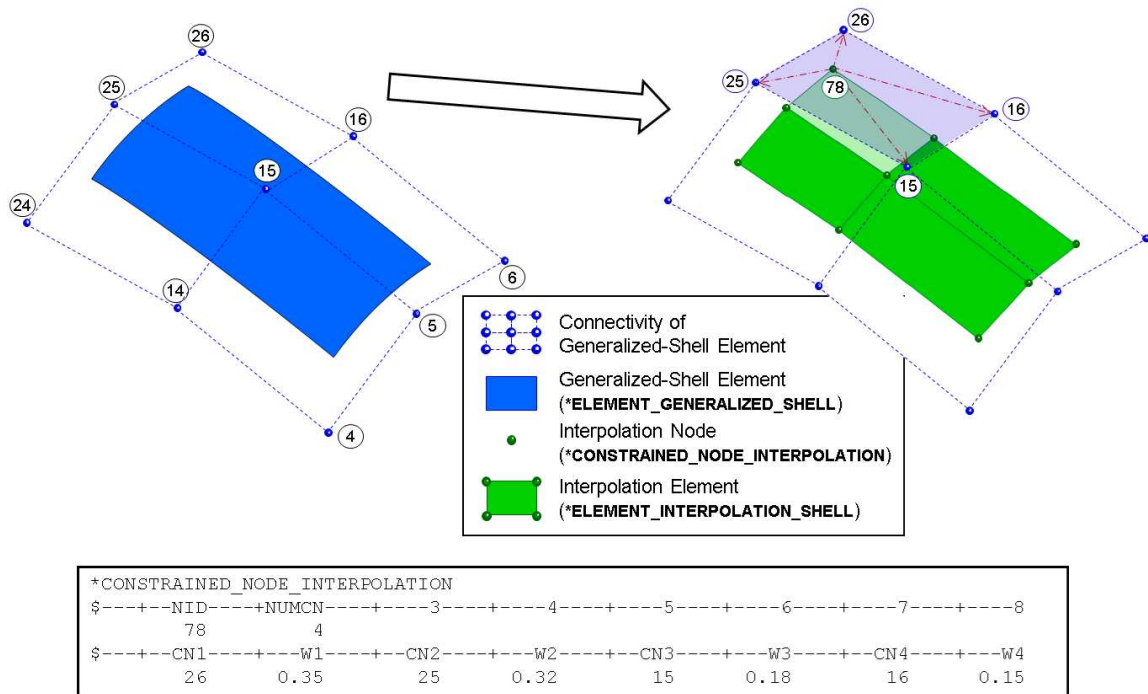
Cards            1            2            3            4            5            6            7            8

Variable	MN5	W5	Etc.	Etc.	Etc.	Etc.	Etc.	Etc.
Type	I	F	I	F	I	F	I	F
Default	none	none	none	none	none	none	none	none

VARIABLE	DESCRIPTION
NID	Node ID of the interpolation node as defined in *NODE (see Remark 1).
NUMMN	Number of master nodes, this constrained node depends on.
MN <sub>i</sub>	Node ID of master node i.
W <sub>i</sub>	Weighting factor of master node i.

**Remarks:**

1. The coordinates of an interpolation node have to be defined in \*NODE. In there the translational and rotational constraints TC=7. and RC=7. need to be set.
2. The displacements of the interpolation node ( $d_{IN}$ ) are interpolated based on the displacements of the corresponding master nodes ( $d_i$ ) and the appropriate weighting factors ( $w_i$ ). The interpolation is computed as follows:  $d_{IN} = \sum_{i=1}^{NUMMN} w_i d_i$



**Figure 9.21.** Example of a \*CONSTRAINED\_NODE\_INTERPOLATION card

**\*CONSTRAINED\_NODE\_SET\_{OPTION}**

To define an ID for the constrained node set the following option is available:

<BLANK>

**ID**

If the ID is defined an additional card is required.

Purpose: Define nodal constraint sets for translational motion in global coordinates. No rotational coupling. See Figure 9.22. Nodal points included in the sets should not be subjected to any other constraints including prescribed motion, e.g., with the \*BOUNDARY\_PRESCRIBED\_MOTION options.

**ID Card - Required if the option ID is active on the keyword card.**

Card 1            1            2            3            4            5            6            7            8

Variable	CNSID								
Type	I								
Default	0								

Card            1            2            3            4            5            6            7            8

Variable	NSID	DOF	TF						
Type	I	I	F						
Default	none	none	1.E+20						
Remarks	1		2						

**VARIABLE****DESCRIPTION**

CNSID

Optional constrained node set ID.

NSID

Nodal set ID, see \*SET\_NODE\_OPTION.

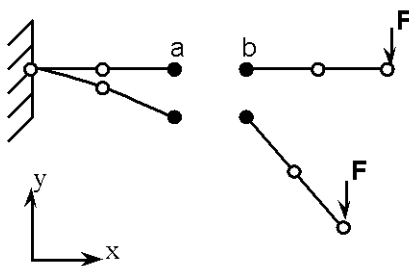
VARIABLE	DESCRIPTION
DOF	Applicable degrees-of-freedom: EQ.1: x-translational degree-of-freedom, EQ.2: y-translational degree-of-freedom, EQ.3: z-translational degree-of-freedom, EQ.4: x and y-translational degrees-of-freedom, EQ.5: y and z-translational degrees-of-freedom, EQ.6: z and x-translational degrees-of-freedom, EQ.7: x, y, and z-translational degrees-of-freedom.
TF	Failure time for nodal constraint set.

**Remarks:**

- The masses of the nodes are summed up to determine the total mass of the constrained set. It must be noted that the definition of a nodal rigid body is not possible with this input. For nodal rigid bodies the keyword input: \*CONSTRAINED\_NODAL\_RIGID\_BODY\_OPTION, must be used.
- When the failure time, TF, is reached the nodal constraint becomes inactive and the constrained nodes may move freely.

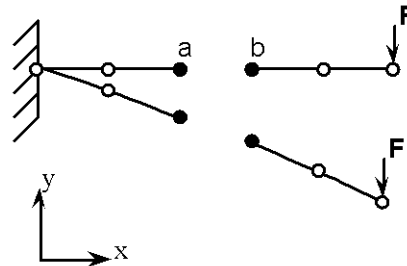
**\*CONSTRAINED\_NODE\_SET**

Since no rotation is permitted, this option should not be used to model rigid body behavior that involves rotations.



**\*CONSTRAINED\_NODAL\_RIGID\_BODY**  
**\*CONSTRAINED\_SPOTWELD**

Behavior is like a rigid beam. These options may be used to model spotwelds.



**Offset nodes a and b are constrained to move together.**

**Figure 9.22.** \*CONSTRAINED\_NODE\_SET can lead to nonphysical responses.



**\*CONSTRAINED\_POINTS****\*CONSTRAINED****\*CONSTRAINED\_POINTS**

Purpose: Constrain two points with the specified coordinates connecting two shell elements at locations other than nodal points. In this option, the penalty method is used to constrain the translational and rotational degrees-of-freedom of the points. Force resultants are written into the SWFORC ASCII file for post-processing.

Card 1            1            2            3            4            5            6            7            8

Variable	CID								
Type	I								
Default	none								

Card 2            1            2            3            4            5            6            7            8            9            10

Variable	EID1	X1	Y1	Z1					
Type	I	F	F	F					
Default	none	0.	0.	0.					

Card 3            1            2            3            4            5            6            7            8            9            10

Variable	EID2	X2	Y2	Z2					
Type	I	F	F	F					
Default	none	0.	0.	0.					

# \*CONSTRAINED

# \*CONSTRAINED\_POINTS

Card 4            1            2            3            4            5            6            7            8

Variable	PSF	FAILA	FAILS	FAILM				
Type	F	F	F	F				
Default	1.0	0.0	0.0	0.0				

## VARIABLE

## DESCRIPTION

CID	Constrained points ID.
Xi, Yi, Zi	Coordinates of the constrained points, i=1,2.
EIDi	Shell element ID, i=1,2.
PSF	Penalty scale factor (Default=1.0).
FAILA	Axial force resultant failure value (Skip if zero).
FAILS	Shear force resultant failure value (Skip if zero).
FAILM	Moment resultant failure value (Skip if zero).



**\*CONSTRAINED\_RIGID\_BODIES**

Purpose: Merge two rigid bodies. One rigid body, called slave rigid body, is merged to the other one called a master rigid body.

Card            1            2            3            4            5            6            7            8

Variable	PIDM	PIDS	IFLAG					
Type	I	I	I					
Default	none	none	0					

<u>VARIABLE</u>	<u>DESCRIPTION</u>
PIDM	Master rigid body part ID, see *PART.
PIDS	Slave rigid body part ID, see *PART.
IFLAG	This flag is meaningful if and only if the inertia properties of the Part ID, PIDM, are defined in PART_INERTIA. If set to unity, the center-of-gravity, the translational mass, and the inertia matrix of PIDM, will be updated to reflect the merging of rigid body PIDS. If IFLAG is defaulted to zero, the merged PIDS will not affect the properties defined in PART_INERTIA for PIDM since it is assumed the properties already account for merged parts. The inertia properties of PIDS will be computed from its nodal masses if the properties are not defined in a PART_INERTIA definition.

**Remarks:**

The slave rigid body is merged to the master rigid body. The inertial properties computed by LS-DYNA are based on the combination of the master rigid body plus all the rigid bodies which are slaved to it unless the inertial properties of the master rigid body are defined via the \*PART\_INERTIA keyword in which case those properties are used for the combination of the master and slave rigid bodies. Note that a master rigid body may have many slaves.

Independent rigid bodies must not share common nodes since each rigid body updates the motion of its nodes independently of the other rigid bodies. If common nodes exist between rigid bodies the rigid bodies sharing the nodes must be merged.

It is also possible to merge rigid bodies that are completely separated and share no common nodal points or boundaries. All actions valid for the master rigid body, e.g., constraints, given velocity, are now also valid for the newly-created rigid body.

```

$$$$$$$$$$$$$$$$$$$$$$$$$$$$$$$$$$$$$$$$$$$$$$$$$$$$$$$$$$$$$$$$$$$$$$$$$$$$$$$$$$$$
$
$$$  *CONSTRAINED_RIGID_BODIES
$
$$$$$$$$$$$$$$$$$$$$$$$$$$$$$$$$$$$$$$$$$$$$$$$$$$$$$$$$$$$$$$$$$$$$$$$$$$$$$$$$$$$$
$
$ Rigidly connect parts 35, 70, 71, and 72 to part 12.
$ All parts must be defined as rigid.
$
$ This example is used to make a single rigid body out of the five parts
$ that compose the back end of a vehicle. This was done to save cpu time
$ and was determined to be valid because the application was a frontal
$ impact with insignificant rear end deformations. (The cpu time saved
$ was from making the parts rigid, not from merging them - merging was
$ more of a convenience in this case for post processing, for checking
$ inertial properties, and for joining the parts.)
$
*CONSTRAINED_RIGID_BODIES
$.>...1.>...2.>...3.>...4.>...5.>...6.>...7.>...8
$   pidm   pids
$       12    35
$       12    70
$       12    71
$       12    72
$
$$$$$$$$$$$$$$$$$$$$$$$$$$$$$$$$$$$$$$$$$$$$$$$$$$$$$$$$$$$$$$$$$$$$$$$$$$$$$$$$$$$$

```

**\*CONSTRAINED\_RIGID\_BODY\_STOPPERS**

Purpose: Rigid body stoppers provide a convenient way of controlling the motion of rigid tooling in metalforming applications. The motion of a “master” rigid body is limited by load curves. This option will stop the motion based on a time dependent constraint. The stopper overrides prescribed motion boundary conditions (except relative displacement) operating in the same direction for both the master and slaved rigid bodies. See Figure 9.23.

Card 1            1            2            3            4            5            6            7            8

Variable	PID	LCMAX	LCMIN	PSIDMX	PSIDMN	LCVMNX	DIR	VID
Type	I	I	I	I	I	I	I	I
Default	required	0	0	0	0	0	required	0

Card 2            1            2            3            4            5            6            7            8

Variable	TB	TD						
Type	F	F						
Default	0	1021						

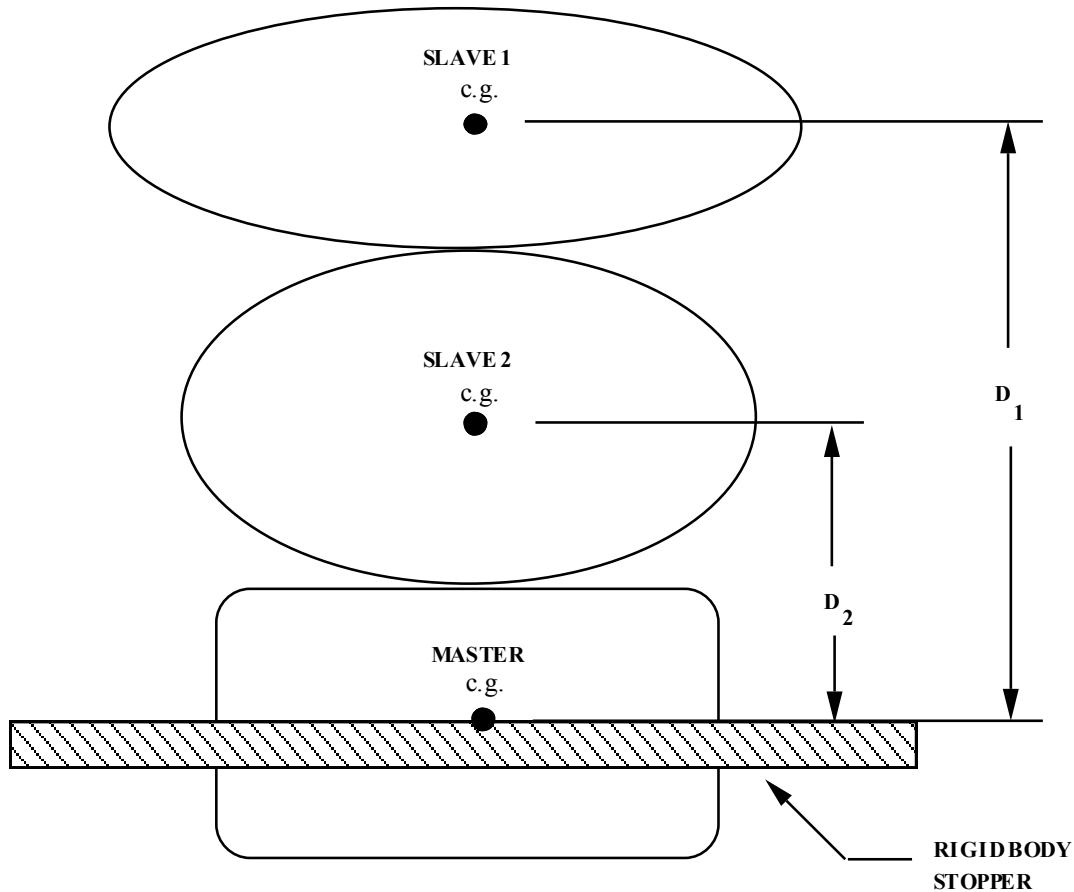
<u>VARIABLE</u>	<u>DESCRIPTION</u>
PID	Part ID of master rigid body, see *PART.
LCMAX	Load curve ID defining the maximum coordinate or displacement as a function of time. See *DEFINE_CURVE: LT.0: Load Curve ID  LCMAX  provides an upper bound for the displacement of the rigid body EQ.0: no limitation of the maximum displacement. GT 0: Load Curve ID LCMAX provides an upper bound for the position of the rigid body center of mass

<b>VARIABLE</b>	<b>DESCRIPTION</b>
LCMIN	Load curve ID defining the minimum coordinate or displacement as a function of time. See *DEFINE_CURVE: LT.0: Load Curve ID  LCMIN  defines a lower bound for the displacement of the rigid body EQ.0: no limitation of the minimum displacement. GT.0: Load Curve ID LCMIN defines a lower bound for the position of the rigid body center of mass
PSIDMX	Optional part set ID of rigid bodies that are slaved in the maximum coordinate direction to the master rigid body. The part set definition, (see *SET_PART_COLUMN) may be used to define the closure distance ( $D_1$ and $D_2$ in Figure 9.23) which activates the constraint. The constraint does not begin to act until the master rigid body stops. If the distance between the master rigid body is greater than or equal to the closure distance, the slave rigid body motion away from the master rigid body also stops. However, the slaved rigid body is free to move towards the master. If the closure distance is input as zero (0.0) then the slaved rigid body stops when the master stops.
PSIDMN	Optional part set ID of rigid bodies that are slaved in the minimum coordinate direction to the master rigid body. The part set definition, (see *SET_PART_COLUMN) may be used to define the closure distance ( $D_1$ and $D_2$ in Figure 9.23) which activates the constraint. The constraint does not begin to act until the master rigid body stops. If the distance between the master rigid body is less than or equal to the closure distance, the slave rigid body motion towards the master rigid body also stops. However, the slaved rigid body is free to move away from the master. If the closure distance is input as zero (0.0) then the slaved rigid body stops when the master stops.
LCVMX	Load curve ID which defines the maximum absolute value of the velocity as a function of time that is allowed for the master rigid body. See *DEFINE_CURVE: EQ.0: no limitation on the velocity.
DIR	Direction stopper acts in: EQ.1: x-translation, EQ.2: y-translation, EQ.3: z-translation, EQ.4: arbitrary, defined by vector VID (see below), EQ.5: x-axis rotation, EQ.6: y-axis rotation, EQ.7: z-axis rotation, EQ.8: arbitrary, defined by vector VID (see below).

VARIABLE	DESCRIPTION
VID	Vector for arbitrary orientation of stopper, see *DEFINE_VECTOR.
TB	Time at which stopper is activated.
TD	Time at which stopper is deactivated.

**Remarks:**

The optional definition of part sets in minimum or maximum coordinate direction allows the motion to be controlled in arbitrary direction.



**Figure 9.23** When the master rigid body reaches the rigid body stopper, the velocity component into the stopper is set to zero. Slave rigid bodies 1 and 2 also stop if the distance between their mass centers and the master rigid body is less than or equal to the input values  $D_1$  and  $D_2$ , respectively. (c.g. + center of gravity).

**\*CONSTRAINED\_RIVET\_{OPTION}**

To define an ID for the rivet, the following option is available:

**ID**

If the ID is defined an additional card is required.

Purpose: Define massless rivets between non-contiguous nodal pairs. The nodes must not have the same coordinates. The action is such that the distance between the two nodes is kept constant throughout any motion. No failure can be specified.

**ID Card - Required if the option ID is active on the keyword card.**

Card 1            1            2            3            4            5            6            7            8

Variable	RID								
Type	I								
Default	0								

Card 1            1            2            3            4            5            6            7            8

Variable	N1	N2	TF						
Type	I	I	F						
Default	none	none	1.E+20						
Remarks	1		2						

<u>VARIABLE</u>	<u>DESCRIPTION</u>
RID	Optional rivet ID.
N1	Node ID
N2	Node ID



**\*CONSTRAINED\_SHELL\_TO\_SOLID**

Purpose: Define a tie between a shell edge and solid elements. Nodal rigid bodies can perform the same function and may also be used.

Card            1            2            3            4            5            6            7            8

Variable	NID	NSID						
Type	I	I						
Default	none	none						
Remarks								

**VARIABLE****DESCRIPTION**

NID	Shell node ID
NSID	Solid nodal set ID, see *SET_NODE_OPTION.

**Remarks:**

The shell-brick interface, an extension of the tied surface capability, ties regions of hexahedron elements to regions of shell elements. A shell node may be tied to up to nine brick nodes lying along the tangent vector to the nodal fiber. See Figure 9.24. During the calculation, the brick nodes thus constrained, must lie along the fiber but can move relative to each other in the fiber direction. The shell node stays on the fiber at the same relative spacing between the first and last brick node. The brick nodes must be input in the order in which they occur, in either the plus or minus direction, as one moves along the shell node fiber.

This feature is intended to tie four node shells to eight node shells or solids; it is not intended for tying eight node shells to eight node solids.





# \*CONSTRAINED

# \*CONSTRAINED\_SHELL\_TO\_SOLID

---

\*CONSTRAINED\_SHELL\_TO\_SOLID

\$...>...1...>...2...>...3...>...4...>...5...>...6...>...7...>...8

```
$      nid      nsid
      329         4
```

\$

\*SET\_NODE\_LIST

```
$      sid
         4
```

```
$      nid1      nid2      nid3      nid4      nid5      nid6      nid7      nid8
      119        161        203        245        287
```

\$

\$

**\*CONSTRAINED\_SPLINE**

Purpose: Define an elastic cubic spline interpolation constraint. The displacements and slopes at the end points are continuous. The first and last nodes, which define the constraint, must be independent. The degrees-of-freedom of interior nodes may be either dependent or independent.

Card 1            1            2            3            4            5            6            7            8

Variable	SPLID	DLRATIO						
Type	I	I						
Default	0	0.10						

**Cards 2, 3, 4, etc. Define one card per independent/dependent node. The first and last nodes must be independent. The next “\*” card terminates this input.**

Card 2...        1            2            3            4            5            6            7            8

Variable	NID	DOF						
Type	I	I						
Default	0	0						

<u>VARIABLE</u>	<u>DESCRIPTION</u>
SPLID	Spline constraint ID.
DLRATIO	Ratio of bending to torsional stiffness for an elastic tubular beam which connects the independent degrees-of-freedom. The default value is set to 0.10.
NID	Independent/dependent node ID. For explicit problems this node should not be a member of a rigid body, or elsewhere constrained in the input.

<u>VARIABLE</u>	<u>DESCRIPTION</u>
DOF	Degrees-of-freedom. The list of dependent degrees-of-freedom consists of a number with up to six digits, with each digit representing a degree of freedom. For example, the value 1356 indicates that degrees of freedom 1, 3, 5, and 6 are controlled by the constraint. The default is 123456. Digit: degree of freedom ID's: EQ.1: x EQ.2: y EQ.3: z EQ.4: rotation about x axis EQ.5: rotation about y axis EQ.6: rotation about z axis

## \*CONSTRAINED\_SPR2

Purpose: Define a self-piercing rivet with failure. This model for a self-piercing rivet (SPR2) includes a plastic-like damage model that reduces the force and moment resultants to zero as the rivet fails. The domain of influence is specified by a diameter, which should be approximately equal to the rivet's diameter. The location of the rivet is defined by a single node at the center of two riveted sheets. The algorithm does a normal projection from the master and slave sheets to the rivet node and locates all nodes within the user-defined diameter of influence. The numerical implementation of this rivet model was developed by L. Olovsson of Impetus Afea, based on research work on SPR point connector models originally carried out by SIMLab (NTNU) and SINTEF, see references by Porcaro, Hanssen, and et.al. [2006, 2006, 2007].

Card 1            1            2            3            4            5            6            7            8

Variable	MID	SID	NSID	THICK	D	FN	FT	DN
Type	I	I	I	F	F	F	F	F
Default	none	none	none	none	none	none	none	none

Card 2            1            2            3            4            5            6            7            8

Variable	DT	XIN	XIT	ALPHA1	ALPHA2	ALPHA3	DENS	INTP
Type	F	F	F	F	F	F	F	F
Default	none	none	none	none	none	none	none	none

**VARIABLE****DESCRIPTION**

MID	Master sheet Part ID
SID	Slave sheet Part ID
NSID	Node set ID of rivet location nodes.
THICK	Total thickness of master and slave sheet.
D	Rivet diameter.

<u>VARIABLE</u>	<u>DESCRIPTION</u>
FN	Rivet strength in tension (pull-out).
FT	Rivet strength in pure shear.
DN	Failure displacement in normal direction.
DT	Failure displacement in tangential direction.
XIN	Fraction of failure displacement at maximum normal force.
XIT	Fraction of failure displacement at maximum tangential force.
ALPHA1	Dimensionless parameter scaling the effective displacement.
ALPHA2	Dimensionless parameter scaling the effective displacement.
ALPHA3	Dimensionless parameter scaling the effective displacement.
DENS	Rivet density (necessary for time step calculation).
INTP	Flag for interpolation. EQ.0: linear (default), EQ.1: uniform, EQ.2: inverse distance weighting.

**Remarks:**

Self piercing rivets are a type of fastener that is sometimes used in place of spot welds to join sheet metal of similar or dissimilar materials. The rivet penetrates the first sheet, expands to interlock with the lower sheet without penetration. The strength and fatigue characteristics of self piercing rivets can meet or even exceed that of spot welds; consequently, their practice applications are expanding.

In the local description of the underlying model, all considerations are done in the plane-of-maximum opening  $\hat{\mathbf{n}}_o = \hat{\mathbf{n}}_s \times \hat{\mathbf{n}}_m$  where the unit normal vectors of the master and slave sheet are  $\hat{\mathbf{n}}_s$  and  $\hat{\mathbf{n}}_m$  (see Figure 9.25). The tangential unit normal vector of the rivet is  $\hat{\mathbf{n}}_t = \hat{\mathbf{n}}_o \times \hat{\mathbf{n}}_m$ . A single-sheet rivet system is assumed, i.e. the rivet translation and rotation follow the motion of the master sheet. The opening appears at the slave sheet.

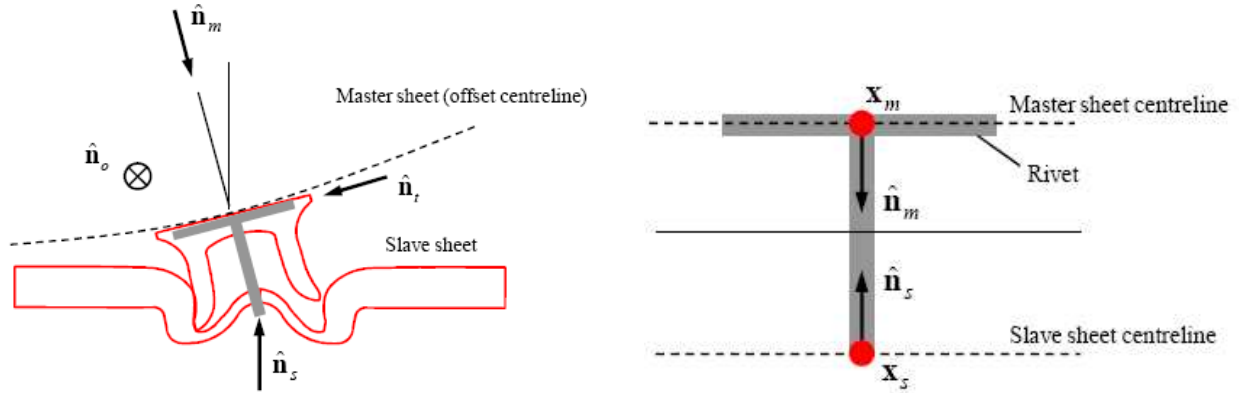


Figure 9.25. Plane-of-maximum opening, single-sheet rivet system.

The local deformation is defined by normal stretch vector  $\delta_n$ , tangential stretch  $\delta_t$  and total stretch  $\delta = \delta_n + \delta_t$  (see Figure 9.26). At any given time the total stretch is computed from the position vectors:  $\delta = x_s^r - x_s^s$  so that the scalar measures of normal stretch and tangential stretch are  $\delta_n = \delta \cdot \hat{n}_n$  and  $\delta_t = \delta \cdot \hat{n}_t$ . The normal and tangential forces  $f_n$  and  $f_t$  are then determined by the material model, which will be explained next. For the moments the following applies at all times:  $M_m + M_s = (h_1 + h_2) f_t / 2$ . The motion, forces and moments are then distributed to the nodes within the radius of influence by a weighting function, which is linear by default at the moment (parameter INTP).

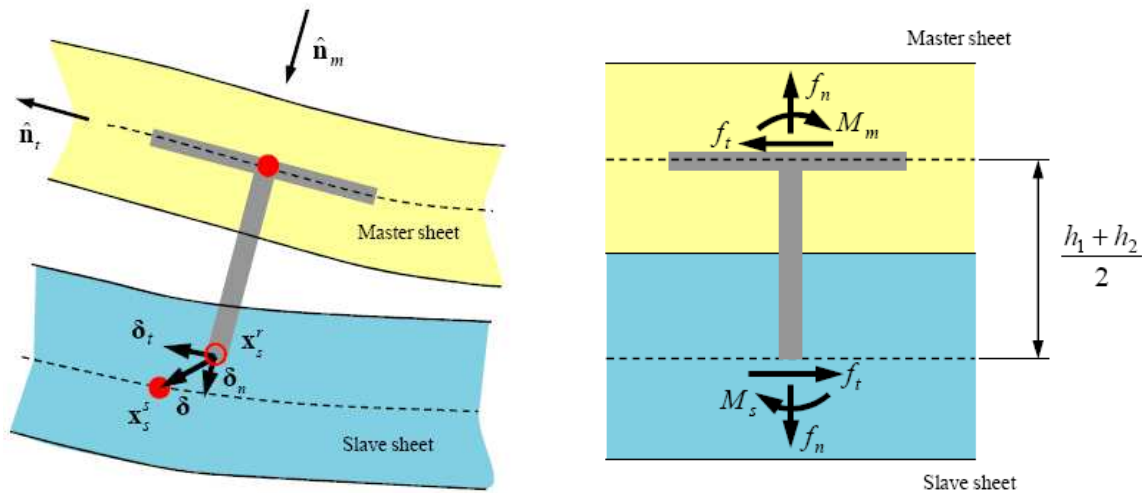
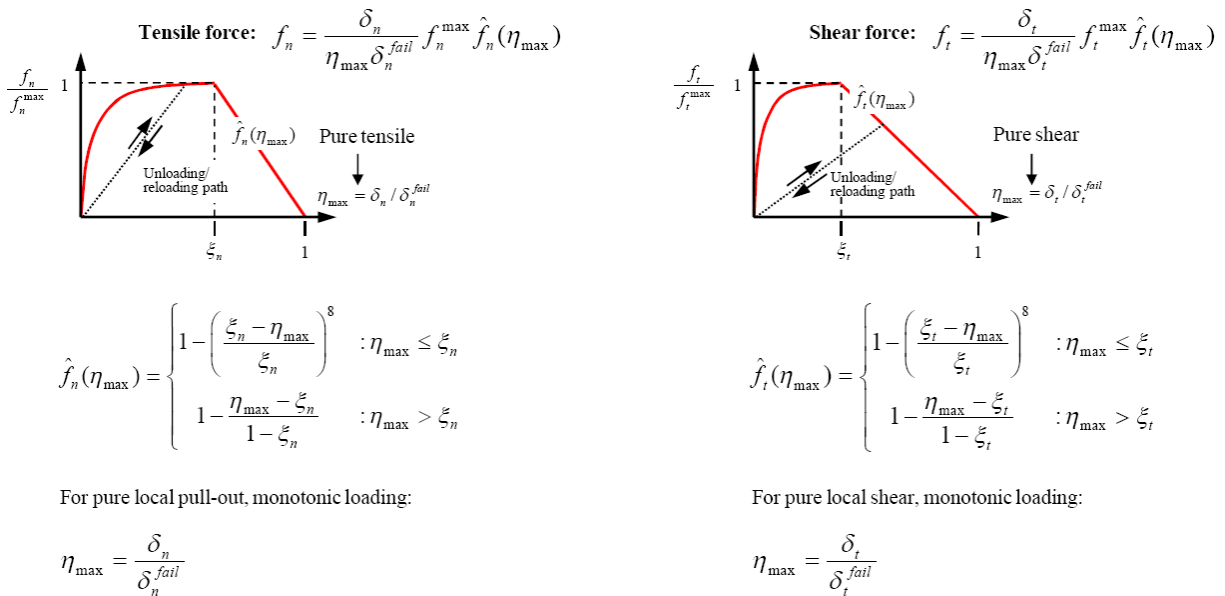


Figure 9.26. Local kinematics, local forces/moments.

The force-deformation relationship is defined by a non-linear damage model for arbitrary mixed-mode loading conditions (combination of tension and shear). For pure tensile and pure shear

loading, the behavior is shown in Figure 9.27. Usually, material parameters  $f_n^{\max}$ ,  $f_t^{\max}$ ,  $\delta_n^{\text{fail}}$ , and  $\delta_t^{\text{fail}}$  can be determined directly from experiments. Material parameters  $\xi_n$ , and  $\xi_t$  can be found by reverse engineering. For mixed-mode behavior, an effective displacement measure  $\eta$  is used (see Figure 9.28), where  $\xi$  is a parameter ranging from 0 to 1, scaling the effective displacement as a function of the direction of the displacement vector in the  $\delta_n - \delta_t$ -plane. The directional scaling of the effective displacement is allowed to change as damage develops. This is done by shape coefficient  $\alpha$ , where associated material parameters are  $\alpha_1$ ,  $\alpha_2$ , and  $\alpha_3$ . The directional dependency of the effective displacement is necessary for an accurate force-displacement response in different loading directions.  $\alpha_1$  and  $\alpha_2$  brings down the force in the peeling and oblique loading cases to the correct level. Both parameters are usually below 1.  $\alpha_3$  generally needs to be larger than 1 and its main effect is to moderate the failure displacement in oblique loading directions.



**Figure 9.27.** Force-deformation relationship: non-linear damage model.



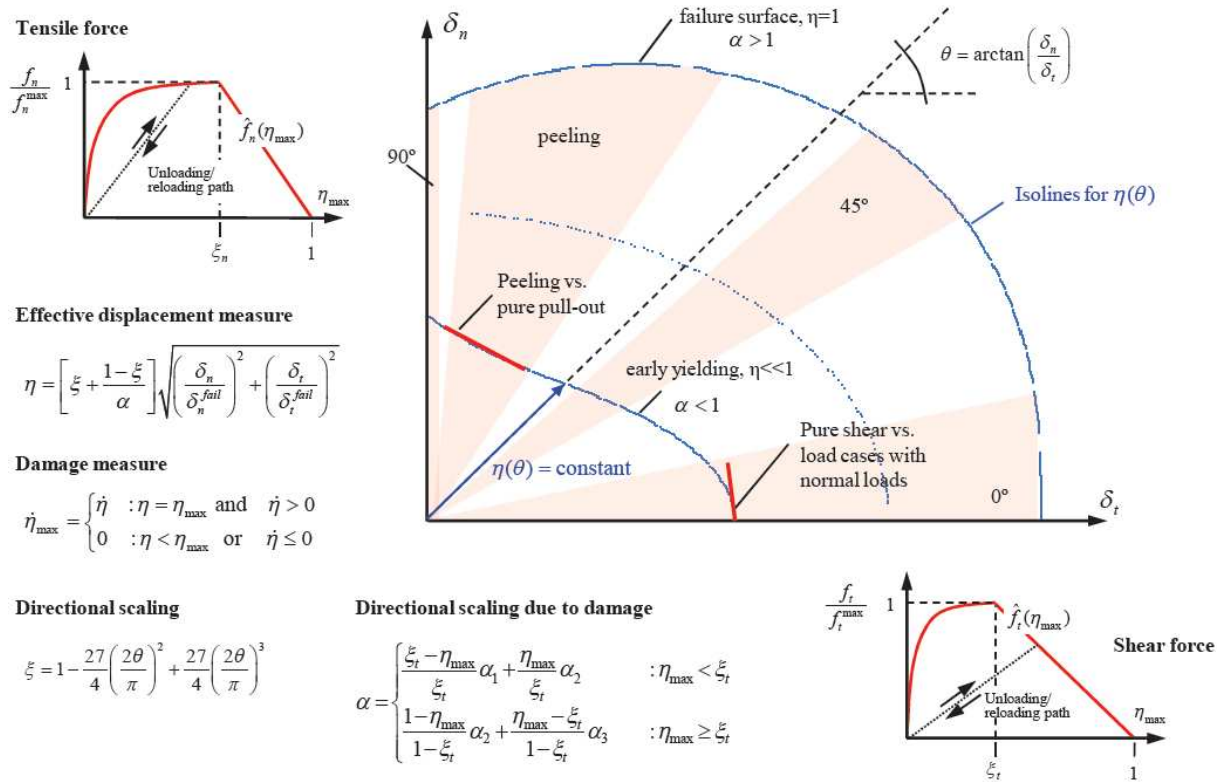


Figure 9.28. Mixed-mode behavior with effective displacement measure.

For the moment distribution, the difference between master sheet (stronger side where the rivet is entered) and slave sheet (weaker side) is accounted for by a gradual transfer from the slave to the master side as damage grows:

$$M_m = \frac{h_1 + h_2}{4} \left( 1 + \frac{\eta_{\max} - \xi_t}{1 - \xi_t} \right) f_t \quad M_s = \frac{h_1 + h_2}{4} \left( 1 - \frac{\eta_{\max} - \xi_t}{1 - \xi_t} \right) f_t$$

Eventually the connection to the slave sheet becomes a moment free hinge.

**\*CONSTRAINED\_SPOTWELD\_{OPTION}\_{OPTION}**

If it is desired to use a time filtered force calculation for the forced based failure criterion then the following option is available:

**FILTERED\_FORCE**

and one additional card must be defined below. To define an ID for the spotweld the following option is available:

**ID**

If the ID is defined an additional card is required. The ordering of the options is arbitrary.

Purpose: Define massless spot welds between non-contiguous nodal pairs. The spot weld is a rigid beam that connects the nodal points of the nodal pairs; thus, nodal rotations and displacements are coupled. The spot welds must be connected to nodes having rotary inertias, i.e., beams or shells. If this is not the case, for example, if the nodes belong to solid elements, use the option: \*CONSTRAINED\_RIVET. For Implicit, this case is treated like a rivet, constraining only the displacements. Note that shell elements do not have rotary stiffness in the normal direction and, therefore, this component cannot be transmitted. Spot welded nodes must not have the same coordinates. Coincident nodes in a spot weld can be handled by the \*CONSTRAINED\_NODAL\_RIGID\_BODY option. Brittle and ductile failures can be specified. Brittle failure is based on the resultant forces acting on the weld, and ductile failure is based on the average plastic strain value of the shell elements which include the spot welded node. Spot welds, which are connected to massless nodes, are automatically deleted in the initialization phase and a warning message is printed in the MESSAG file and the D3HSP file.

Warning: The accelerations of spot welded nodes are output as zero into the various databases, but if the acceleration of spotwelded nodes are required, use either the \*CONSTRAINED\_GENERALIZED\_WELD or the \*CONSTRAINED\_NODAL\_RIGID\_BODY input. However, if the output interval is frequent enough accurate acceleration time histories can be obtained from the velocity time history by differentiation in the post-processing phase.

**ID Card - Required if the option ID is active on the keyword card.**

Card 1            1            2            3            4            5            6            7            8

Variable	WID								
Type	I								
Default	0								

Card 1            1            2            3            4            5            6            7            8

Variable	N1	N2	SN	SS	N	M	TF	EP
Type	I	I	F	F	F	F	F	F
Default	none	none	optional	optional	none	none	1.E+20	1.E+20
Remarks	1.		2.				3	4

**Define if and only if the option FILTERED\_FORCE is specified.**

Card 2            1            2            3            4            5            6            7            8

Variable	NF	TW						
Type	I	F						
Default	none	none						
Remarks								

<u>VARIABLE</u>	<u>DESCRIPTION</u>
WID	Optional weld ID.
N1	Node ID
N2	Node ID
SN	Normal force at spotweld failure (see Remark 2 below).
SS	Shear force at spotweld failure (see Remark 2 below).
N	Exponent for normal spotweld force (see Remark 2 below).
M	Exponent for shear spotweld force (see Remark 2 below).
TF	Failure time for nodal constraint set.

VARIABLE	DESCRIPTION
EP	Effective plastic strain at failure.
NF	Number of force vectors stored for filtering.
TW	Time window for filtering.

**Remarks:**

1. Nodes connected by a spot weld cannot be members of another constraint set that constrain the same degrees-of-freedom, a tied interface, or a rigid body, i.e., nodes cannot be subjected to multiple, independent, and possibly conflicting constraints. Also, care must be taken to ensure that single point constraints applied to nodes in a constraint set do not conflict with the constraint sets constrained degrees-of-freedom.

2. Failure of the spot welds occurs when:

$$\left(\frac{|f_n|}{S_n}\right)^n + \left(\frac{|f_s|}{S_s}\right)^m \geq 1$$

where  $f_n$  and  $f_s$  are the normal and shear interface force. Component  $f_n$  is nonzero for tensile values only.

3. When the failure time, TF, is reached the spot weld becomes inactive and the constrained nodes may move freely.

4. Spot weld failure due to plastic straining occurs when the effective nodal plastic strain exceeds the input value,  $\epsilon_{fail}^p$ . This option can model the tearing out of a spotweld from the sheet metal since the plasticity is in the material that surrounds the spotweld, not the spotweld itself. A least squares algorithm is used to generate the nodal values of plastic strains at the nodes from the element integration point values. The plastic strain is integrated through the element and the average value is projected to the nodes via a least square fit. This option should only be used for the material models related to metallic plasticity and can result in slightly increased run times. Failures can include both the plastic and brittle failures.

```

$$$$$$$$$$$$$$$$$$$$$$$$$$$$$$$$$$$$$$$$$$$$$$$$$$$$$$$$$$$$$$$$$$$$$$$$$$$$$$$$$$$$
$
$$$$ *CONSTRAINED_SPOTWELD
$
$$$$$$$$$$$$$$$$$$$$$$$$$$$$$$$$$$$$$$$$$$$$$$$$$$$$$$$$$$$$$$$$$$$$$$$$$$$$$$$$$$$$
$

```



**\*CONSTRAINED\_TIE-BREAK**

Purpose: Define a tied shell edge to shell edge interface that can release locally as a function of plastic strain of the shells surrounding the interface nodes. A rather ductile failure is achieved.

Card            1            2            3            4            5            6            7            8

Variable	SNSID	MNSID	EPPF					
Type	I	I	F					
Default	none	none	0.					
Remarks		1, 2	3, 4					

**VARIABLE****DESCRIPTION**

SNSID	Slave node set ID, see *SET_NODE_OPTION.
MNSID	Master node set ID, see *SET_NODE_OPTION.
EPPF	Plastic strain at failure

**Remarks:**

- Nodes in the master node set must be given in the order they appear as one moves along the edge of the surface.
- Tie-breaks may not cross.
- Tie-breaks may be used to tie shell edges together with a failure criterion on the joint. If the average volume-weighted effective plastic strain in the shell elements adjacent to a node exceeds the specified plastic strain at failure, the node is released. The default plastic strain at failure is defined for the entire tie-break but can be overridden in the slave node set to define a unique failure plastic strain for each node.
- Tie-breaks may be used to simulate the effect of failure along a predetermined line, such as a seam or structural joint. When the failure criterion is reached in the adjoining elements, nodes along the slideline will begin to separate. As this effect propagates, the tie-breaks will appear to “unzip,” thus simulating failure of the connection.

**\*CONSTRAINED\_TIED\_NODES\_FAILURE**

Purpose: Define a tied node set with failure based on plastic strain. The nodes must be coincident.

Card            1            2            3            4            5            6            7            8

Variable	NSID	EPPF	ETYPE					
Type	I	F						
Default	none	0.						
Remarks	1, 2, 3, 4							

<u>VARIABLE</u>	<u>DESCRIPTION</u>
NSID	Nodal set ID, see *SET_NODE_OPTION.
EPPF	Plastic strain at failure
ETYPE	Element type for nodal group: EQ.0: shell, EQ.1: solid element

**Remarks:**

1. This feature applies to solid and shell elements using plasticity material models, and to solid elements using the honeycomb material \*MAT\_HONEYCOMB (EPPF=plastic volume strain). The specified nodes are tied together until the average volume weighted plastic strain exceeds the specified value. Entire regions of individual shell elements may be tied together unlike the tie-breaking shell slidelines. The tied nodes are coincident until failure. When the volume weighted average of the failure value is reached for a group of constrained nodes, the nodes of the elements that exceed the failure value are released to simulate the formation of a crack.
2. To use this feature to simulate failure, each shell element in the failure region should be generated with unique node numbers that are coincident in space with those of adjacent elements. Rather than merging these coincident nodes, the \*CONSTRAINED\_TIED\_NODES\_FAILURE option ties the nodal points together. As plastic strain develops and exceeds the failure strain, cracks will form and propagate through the mesh.

- 3. Entire regions of individual shell elements may be tied together, unlike the \*CONSTRAINED\_TIE-BREAK option. This latter option is recommended when the location of failure is known, e.g., as in the plastic covers which hide airbags in automotive structures.
- 4. When using surfaces of shell elements defined using the \*CONSTRAINED\_TIED\_NODES\_FAILURE option in contact, it is best to defined each node in the surface as a slave node with the NODE\_TO\_SURFACE contact options. If this is not possible, the automatic contact algorithms beginning with \*CONTACT\_AUTOMATIC\_... all of which include thickness offsets are recommended.

```

$$$$$$$$$$$$$$$$$$$$$$$$$$$$$$$$$$$$$$$$$$$$$$$$$$$$$$$$$$$$$$$$$$$$$$$$$$$$$$$$
$
$$$  *CONSTRAINED_TIED_NODES_FAILURE
$
$$$$$$$$$$$$$$$$$$$$$$$$$$$$$$$$$$$$$$$$$$$$$$$$$$$$$$$$$$$$$$$$$$$$$$$$$$$$$$$$
$
$ Tie shell elements together at the nodes specified in nodal set 101. The
$ constraint will be broken when the plastic strain at the nodes exceeds 0.085.
$
$ In this example, four shell elements come together at a common point.
$ The four corners of the shells are tied together with failure as opposed
$ to the more common method of merging the nodes in the pre-processing stage.
$
*CONSTRAINED_TIED_NODES_FAILURE
$
$.>...1.>...2.>...3.>...4.>...5.>...6.>...7.>...8
$  nsid      eppf
$    101      0.085
$
$
*SET_NODE_LIST
$   sid
$   101
$   nid1      nid2      nid3      nid4      nid5      nid6      nid7      nid8
$     775       778       896       897
$
$$$$$$$$$$$$$$$$$$$$$$$$$$$$$$$$$$$$$$$$$$$$$$$$$$$$$$$$$$$$$$$$$$$$$$$$$$$$$$$$

```



# **\*CONTACT**

The keyword **\*CONTACT** provides a way of treating interaction between disjoint parts. Different types of contact may be defined:

**\*CONTACT\_OPTION1\_{OPTION2}\_{OPTION3}\_{OPTION4}\_{OPTION5}**

**\*CONTACT\_AUTO\_MOVE**

**\*CONTACT\_COUPLING**

**\*CONTACT\_ENTITY**

**\*CONTACT\_GEBOD\_OPTION**

**\*CONTACT\_GUIDED\_CABLE**

**\*CONTACT\_INTERIOR**

**\*CONTACT\_RIGID\_SURFACE**

**\*CONTACT\_1D**

**\*CONTACT\_2D\_OPTION1\_{OPTION2}\_{OPTION3}**

The first, **\*CONTACT\_...**, is the general 3D contact algorithms. The second, **\*CONTACT\_COUPLING**, provides a means of coupling to deformable surfaces to MADYMO. The third, **\*CONTACT\_ENTITY**, treats contact using mathematical functions to describe the surface geometry for the master surface. The fourth, **\*CONTACT\_GEBOD** is a specialized form of the contact entity for use with the rigid body dummies (see **\*COMPONENT\_GEBOD**). The fifth, **\*CONTACT\_INTERIOR**, is under development and is used with soft foams where element inversion is sometimes a problem. Contact between layers of brick elements is treated to eliminate negative volumes. The sixth, **\*CONTACT\_RIGID\_SURFACE** is for modeling road surfaces for durability and NVH calculations. The seventh, **\*CONTACT\_1D**, remains in LS-DYNA for historical reasons, and is sometimes still used to model rebars which run along edges of brick elements. The last, **\*CONTACT\_2D**, is the general 2D contact algorithm based on those used previously in LS-DYNA2D.

# **\*CONTACT**

**\*CONTACT\_OPTION1\_{OPTION2}...**

**\*CONTACT\_OPTION1\_{OPTION2}\_{OPTION3}\_{OPTION4}\_{OPTION5}\_{OPTION6}**

Purpose: Define a contact interface.

OPTION1 specifies the contact type. Not all options are implemented for implicit solutions. A list of available contact options is given in Remark 4:

**AIRBAG\_SINGLE\_SURFACE**  
**AUTOMATIC\_BEAMS\_TO\_SURFACE**  
**AUTOMATIC\_GENERAL**  
**AUTOMATIC\_GENERAL\_INTERIOR**  
**AUTOMATIC\_NODES\_TO\_SURFACE**  
**AUTOMATIC\_NODES\_TO\_SURFACE\_SMOOTH**  
**AUTOMATIC\_ONE\_WAY\_SURFACE\_TO\_SURFACE**  
**AUTOMATIC\_ONE\_WAY\_SURFACE\_TO\_SURFACE\_TIEBREAK**  
**AUTOMATIC\_ONE\_WAY\_SURFACE\_TO\_SURFACE\_SMOOTH**  
**AUTOMATIC\_SINGLE\_SURFACE**  
**AUTOMATIC\_SINGLE\_SURFACE\_MORTAR**  
**AUTOMATIC\_SINGLE\_SURFACE\_SMOOTH**  
**AUTOMATIC\_SURFACE\_TO\_SURFACE**  
**AUTOMATIC\_SURFACE\_TO\_SURFACE\_MORTAR**  
**AUTOMATIC\_SURFACE\_TO\_SURFACE\_MORTAR\_TIED**  
**AUTOMATIC\_SURFACE\_TO\_SURFACE\_TIEBREAK**  
**AUTOMATIC\_SURFACE\_TO\_SURFACE\_SMOOTH**  
**CONSTRAINT\_NODES\_TO\_SURFACE**  
**CONSTRAINT\_SURFACE\_TO\_SURFACE**  
**DRAWBEAD**  
**ERODING\_NODES\_TO\_SURFACE**  
**ERODING\_SINGLE\_SURFACE**  
**ERODING\_SURFACE\_TO\_SURFACE**  
**FORCE\_TRANSDUCER\_CONSTRAINT**  
**FORCE\_TRANSDUCER\_PENALTY**  
**FORMING\_NODES\_TO\_SURFACE**  
**FORMING\_NODES\_TO\_SURFACE\_SMOOTH**  
**FORMING\_ONE\_WAY\_SURFACE\_TO\_SURFACE**  
**FORMING\_SURFACE\_TO\_SURFACE\_MORTAR**  
**FORMING\_ONE\_WAY\_SURFACE\_TO\_SURFACE\_SMOOTH**  
**FORMING\_SURFACE\_TO\_SURFACE**  
**FORMING\_SURFACE\_TO\_SURFACE\_SMOOTH**  
**NODES\_TO\_SURFACE**  
**NODES\_TO\_SURFACE\_INTERFERENCE**  
**NODES\_TO\_SURFACE\_SMOOTH**  
**ONE\_WAY\_SURFACE\_TO\_SURFACE**  
**ONE\_WAY\_SURFACE\_TO\_SURFACE\_INTERFERENCE**  
**ONE\_WAY\_SURFACE\_TO\_SURFACE\_SMOOTH**  
**RIGID\_NODES\_TO\_RIGID\_BODY**  
**RIGID\_BODY\_ONE\_WAY\_TO\_RIGID\_BODY**

**RIGID\_BODY\_TWO\_WAY\_TO\_RIGID\_BODY**  
**SINGLE\_EDGE**  
**SINGLE\_SURFACE**  
**SLIDING\_ONLY**  
**SLIDING\_ONLY\_PENALTY**  
**SPOTWELD**  
**SPOTWELD\_WITH\_TORSION**  
**SPOTWELD\_WITH\_TORSION\_PENALTY**  
**SURFACE\_TO\_SURFACE**  
**SURFACE\_TO\_SURFACE\_INTERFERENCE**  
**SURFACE\_TO\_SURFACE\_SMOOTH**  
**SURFACE\_TO\_SURFACE\_CONTRACTION\_JOINT**  
**TIEBREAK\_NODES\_TO\_SURFACE**  
**TIEBREAK\_NODES\_ONLY**  
**TIEBREAK\_SURFACE\_TO\_SURFACE**  
**TIED\_NODES\_TO\_SURFACE**  
**TIED\_SHELL\_EDGE\_TO\_SURFACE**  
**TIED\_SURFACE\_TO\_SURFACE**  
**TIED\_SURFACE\_TO\_SURFACE\_FAILURE**

OPTION2 specifies a thermal contact and is defined by either:

**THERMAL**  
**THERMAL\_FRICTION**

Only the SURFACE\_TO\_SURFACE contact type may be used with this option.

OPTION3 specifies that the first card to read defines the heading and ID number of contact interface and takes the single option:

**ID**

OPTION4 specifies that offsets may be used with the tied contacts types. If one of these three offset options is set, then offsets are permitted for these contact types, and, if not, the nodes are projected back to the contact surface during the initialization phase and a constraint formulation is used. Note that in a constraint formulation the nodes of rigid bodies are not permitted in the definition.

**OFFSET**

Contact types TIED\_NODES\_TO\_SURFACE, TIED\_SHELL\_EDGE\_TO\_SURFACE, and TIED\_SURFACE\_TO\_SURFACE may be used with this option. The OFFSET option switches the formulation from a constraint type formulation to one that is penalty based where the force and moment (if applicable) resultants are transferred discrete spring elements between the slave nodes and master segments. For the TIED\_SHELL\_EDGE\_TO\_SURFACE contact, the BEAM\_OFFSET option may be preferred. Rigid bodies can be used with this option. It is recommended that the nodal points in TIED\_NODES\_TO\_SURFACE and TIED\_SURFACE\_TO\_SURFACE not be

connected to structural nodes, i.e., nodes with rotational degrees-of-freedom, since the rotational degrees-of-freedom are not affected. Doing so may lead to instability since the translational motions due to rotation are imposed on the slave nodes.

**BEAM\_OFFSET**

This option applies only to contact types TIED\_SHELL\_EDGE\_TO\_SURFACE and SPOTWELD. If this option is set, then offsets are permitted for these contact types. The BEAM\_OFFSET option switches the formulation from a constraint type formulation to one that is penalty based. Beam like springs are used to transfer force and moment resultants between the slave nodes and the master segments. Rigid bodies can be used with this option.

**CONSTRAINED\_OFFSET**

Contact types TIED\_NODES\_TO\_SURFACE, TIED\_SHELL\_EDGE\_TO\_SURFACE, TIED\_SURFACE\_TO\_SURFACE and SPOTWELD, may be used with this option. If this option is set, then offsets are permitted for these contact types. The CONSTRAINED\_OFFSET option is a constraint type formulation. The nodal points in TIED\_NODES\_TO\_SURFACE and TIED\_SURFACE\_TO\_SURFACE may not be connected to structural nodes, i.e., nodes with rotational degrees-of-freedom, since the rotational degrees-of-freedom are not affected, which will lead to an instability since the translational motions due to rotation are imposed on the slave nodes.

OPTION5 gives extra options specifically for MPP implementation.

**MPP**

OPTION6 requires orthotropic friction coefficients.

**ORTHO\_FRICTION****Remarks:**

1. OPTION1, OPTION2, OPTION3, OPTION4, OPTION5, and OPTION6 may appear in any order in the keyword command line. The data must be in the order specified below.
2. OPTION1 is mandatory.
3. OPTION2, OPTION3, OPTION4, OPTION5, and OPTION6 are optional.
4. The following contact types are available for implicit calculations:

SURFACE\_TO\_SURFACE  
SURFACE\_TO\_SURFACE\_SMOOTH  
SURFACE\_TO\_SURFACE\_CONTRACTION\_JOINT  
NODES\_TO\_SURFACE  
NODES\_TO\_SURFACE\_SMOOTH

ONE\_WAY\_SURFACE\_TO\_SURFACE  
ONE\_WAY\_SURFACE\_TO\_SURFACE\_SMOOTH  
FORMING\_SURFACE\_TO\_SURFACE  
FORMING\_NODES\_TO\_SURFACE  
FORMING\_ONE\_WAY\_SURFACE\_TO\_SURFACE  
FORMING\_SURFACE\_TO\_SURFACE\_MORTAR  
AUTOMATIC\_BEAMS\_TO\_SURFACE  
AUTOMATIC\_SURFACE\_TO\_SURFACE  
AUTOMATIC\_SURFACE\_TO\_SURFACE\_MORTAR  
AUTOMATIC\_SURFACE\_TO\_SURFACE\_MORTAR\_TIED  
AUTOMATIC\_SURFACE\_TO\_SURFACE\_SMOOTH  
AUTOMATIC\_NODES\_TO\_SURFACE  
AUTOMATIC\_NODES\_TO\_SURFACE\_SMOOTH  
AUTOMATIC\_ONE\_WAY\_SURFACE\_TO\_SURFACE  
AUTOMATIC\_ONE\_WAY\_SURFACE\_TO\_SURFACE\_SMOOTH  
AUTOMATIC\_SINGLE\_SURFACE  
AUTOMATIC\_SINGLE\_SURFACE\_MORTAR  
AUTOMATIC\_SINGLE\_SURFACE\_SMOOTH  
TIED\_SURFACE\_TO\_SURFACE  
TIED\_NODES\_TO\_SURFACE  
TIED\_SHELL\_EDGE\_TO\_SURFACE  
TIED\_SURFACE\_TO\_SURFACE\_OFFSET  
TIED\_NODES\_TO\_SURFACE\_OFFSET  
TIED\_SHELL\_EDGE\_TO\_SURFACE\_OFFSET  
TIED\_SURFACE\_TO\_SURFACE\_BEAM\_OFFSET  
TIED\_NODES\_TO\_SURFACE\_BEAM\_OFFSET  
TIED\_SHELL\_EDGE\_TO\_SURFACE\_BEAM\_OFFSET  
TIED\_SURFACE\_TO\_SURFACE\_CONSTRAINED\_OFFSET  
TIED\_NODES\_TO\_SURFACE\_CONSTRAINED\_OFFSET  
TIED\_SHELL\_EDGE\_TO\_SURFACE\_CONSTRAINED\_OFFSET  
2D\_AUTOMATIC\_SURFACE\_TO\_SURFACE

5. For smooth contact, a smooth curve-fitted surface is used to represent the master segment, so that it can provide a more accurate representation of the actual surface, reduce the contact noise, and produce smoother results with coarse mesh. All the smooth contacts are available for MPP, only the forming smooth contacts are available for SMP. For surface\_to\_surface and single\_surface smooth contacts in MPP, both the slave and master sides are smoothed, thereby slowing the contact treatment considerably. The smooth option does not apply to segment based (SOFT=2) contacts.

## DISCUSSION AND EXAMPLES:

A brief discussion on the contact types and a few examples are provided at the end of this section. A theoretical discussion is provided in the LS-DYNA Theory Manual.

**Card ordering is important in this section:**

- **Card for the ID option is inserted here; otherwise, do not define this card.**

Define the ID and heading card first.

- **Card for the \_MPP option is inserted here; otherwise, do not define this card.**
- **Cards 1 to 3 are mandatory for all contact types.**
- **Card 4 is mandatory for the following contact types:**

- \*CONTACT\_CONSTRAINT\_type**
- \*CONTACT\_DRAWBEAD**
- \*CONTACT\_ERODING\_type**
- \*CONTACT\_...\_INTERFERENCE**
- \*CONTACT\_RIGID\_type**
- \*CONTACT\_TIEBREAK\_type**
- \*CONTACT\_...\_CONTRACTION\_JOINT\_type**

Each of these types have different Card 4 formats. These card formats are presented in this manual after the optional cards specified above but, if used, Card 4 needs to be specified in your dyna deck before the optional cards.

- **Card for the THERMAL option is inserted here; otherwise, do not define this card.**

Additional parameters are required for thermal contact and are defined on this card.

- **Card for the ORTHO\_FRICTION option is inserted here; otherwise, do not define this card.**

Four additional cards are required to define the frictional coefficients.

- **Optional Card A**

Additional contact parameters that may be user specified. Default values have evolved over time to become pretty good values for most circumstances.

- **Optional Card B, C, and D**

Additional contact parameters that may be user specified. If Optional Card B is used, then Optional Card A is mandatory (use a blank line if no changes are desired for Card A parameters). Similarly, to use Optional Card C or D, the optional cards that precede them must be present but may be blank lines.



# \*CONTACT

\*CONTACT\_OPTION1\_{OPTION2}...

The following card is defined only if the MPP option is specified.

MPP Card      1            2            3            4            5            6            7            8

Variable	IGNORE	BUCKET	LCBUCKET	NS2TRACK	INITITER	PARMAX		C Parm8
Type	I	I	I	I	I	F		I
Default	0	200	none	3	2	1.0005		0

## VARIABLE

## DESCRIPTION

IGNORE	This is the same as the “ignore initial penetrations” option on the *CONTROL_CONTACT Optional Card C entry 2 and can also be specified in the normal contact control cards. It predates both of those, and is not really needed anymore since both are honored by the MPP code. That is, if any of the three are on, initial penetrations are tracked.
BUCKET	Bucketsort frequency. This field is the only way to specify the bucketsort frequency for the MPP code. The BSORT option on Optional Card A is ignored.
LCBUCKET	Loadcurve for bucketsort frequency. The normal input for this is ignored by MPP.
NS2TRACK	Number of potential contacts to track for each slave node. The normal input for this (DEPTH on Optional Card A) is ignored.
INITITER	Number of iterations to perform when trying to eliminate initial penetrations.
PARMAX	The parametric extension distance for contact segments. The MAXPAR parameter on Optional Card A is not used.
C Parm8	Exclude beam to beam contact from the same PID for AUTOMATIC_GENERAL. EQ.0: disable (default) EQ.1: enable



The following card is read if and only if “&” is defined in column 1 of the first field.

Optional MPP card      1            2            3            4            5            6            7            8

Variable		CHKSEGS	PENSF	GRPABLE				
Type		I	F	I				
Default		0	1.0	0				

**VARIABLE****DESCRIPTION**

CHKSEGS

If this value is non-zero, then the node to surface and surface to surface contacts will perform a special check at time 0 for elements that are inverted (or nearly so), and remove them from contact. These poorly formed elements have been known to occur on the tooling in metalforming problems, which allows these problems to run. It should not normally be needed for reasonable meshes.

PENSF

This option is used together with IGNORE for 3D forging problems. If non-zero, the IGNORED penetration distance is multiplied by this value each cycle, effectively pushing the slave node back out to the surface. This is useful for nodes that might get generated below the master surface during 3D remeshing. Care should be exercised, as energy may be generated and stability may be effected for values lower than 0.95. A value in the range of 0.98 to 0.99 or higher (but < 1.0) is recommended.

GRPABLE

Set to 1 to invoke an alternate MPP communication algorithm for SINGLE\_SURFACE, NODE\_TO\_SURFACE, and SURFACE\_TO\_SURFACE contacts. The new algorithm does not support all contact options, including SOFT=2, as of yet, and is still under development. It can be significantly faster and scale better than the normal algorithm when there are more than two or three applicable contact types defined in the model. Its intent is to speed up the contact processing but not to change the behavior of the contact. See also \*CONTROL\_MPP\_CONTACT\_GROUPABLE.

## Card 1

This card is mandatory for all contact types.

Card 1	1	2	3	4	5	6	7	8
Variable	SSID	MSID	SSTYP	MSTYP	SBOXID	MBOXID	SPR	MPR
Type	I	I	I	I	I	I	I	I
Default	none	none	none	none			0	0
Remarks	1	2			optional	optional	0=off	0=off

### VARIABLE

### DESCRIPTION

SSID	Slave segment, node set ID, part set ID, part ID, or shell element set ID, see *SET_SEGMENT, *SET_NODE_OPTION, *PART, *SET_PART or *SET_SHELL_OPTION. For eroding contact use either a part ID or a part set ID. EQ.0: all part IDs are included for single surface contact, automatic single surface, and eroding single surface.
MSID	Master segment set ID, part set ID, part ID, or shell element set ID, see *SET_SEGMENT, *SET_NODE_OPTION, *PART, *SET_PART, or *SET_SHELL_OPTION: EQ.0: for single surface contact, automatic single surface, and eroding single surface.
SSTYP	ID type of SSID: EQ.0: segment set ID for surface-to-surface contact, EQ.1: shell element set ID for surface-to-surface contact, EQ.2: part set ID, EQ.3: part ID, EQ.4: node set ID for node to surface contact, EQ.5: include all for single surface definition. EQ.6: part set ID for exempted parts. All non-exempted parts are included in the contact. For *AUTOMATIC_BEAMS_TO_SURFACE contact either a part set ID or a part ID can be specified.

<b>VARIABLE</b>	<b>DESCRIPTION</b>
MSTYP	ID type of MSID: EQ.0: segment set ID, EQ.1: shell element set ID, EQ.2: part set ID, EQ.3: part ID.
SBOXID	Include in contact definition only those slave nodes/segments within box SBOXID (corresponding to BOXID in *DEFINE_BOX), or if SBOXID is negative, only those slave nodes/segments within contact volume  SBOXID  (corresponding to CVID in *DEFINE_CONTACT_VOLUME). SBOXID can be used only if SSTYP is set to 2 or 3, i.e., SSID is a part ID or part set ID.
MBOXID	Include in contact definition only those master segments within box MBOXID (corresponding to BOXID in *DEFINE_BOX), or if MBOXID is negative, only those master segments within contact volume  MBOXID  (corresponding to CVID in *DEFINE_CONTACT_VOLUME). MBOXID can be used only if MSTYP is set to 2 or 3, i.e., MSID is a part ID or part set ID.
SPR	Include the slave side in the *DATABASE_NCFORC and the *DATABASE_BINARY_INTFOR interface force files: EQ.1: slave side forces included.
MPR	Include the master side in the *DATABASE_NCFORC and the *DATABASE_BINARY_INTFOR interface force files: EQ.1: master side forces included.

**Remarks:**

1. Giving a slave set ID equal to zero is valid only for the single surface contact algorithms, i.e., the options SINGLE\_SURFACE, and the AUTOMATIC\_, AIRBAG\_, and ERODING\_SINGLE\_SURFACE options.
2. A master set ID is not defined for the single surface contact algorithms (including AUTOMATIC\_GENERAL). A master set ID is optional for FORCE\_TRANSDUCERS. If a master set is defined for the FORCE\_TRANSDUCER option, only those force that develop between and master and slave surfaces are considered. The master surface option is only implemented for the \_PENALTY option and works only with the AUTOMATIC\_SINGLE\_SURFACE contact types.

**Card 2****This card is mandatory for all contact types.**

Card 2            1            2            3            4            5            6            7            8

Variable	FS	FD	DC	VC	VDC	PENCHK	BT	DT
Type	F	F	F	F	F	I	F	F
Default	0.	0.	0.	0.	0.	0	0.	1.0E20
Remarks								

**VARIABLE****DESCRIPTION**

FS

Static coefficient of friction if FS is >0 and not equal to 2. The frictional coefficient is assumed to be dependent on the relative velocity  $v_{rel}$  of the surfaces in contact  $\mu_c = FD + (FS - FD)e^{-DC|v_{rel}|}$ . The two other possibilities are:

EQ.-2: If only the one friction table is defined it will be used and there is no need to define parameter FD. If more than one friction table is defined then the Table ID is defined by the FD Parameter below.

EQ.-1: If the frictional coefficients defined in the \*PART section are to be used, set FS to the negative number, -1.0.

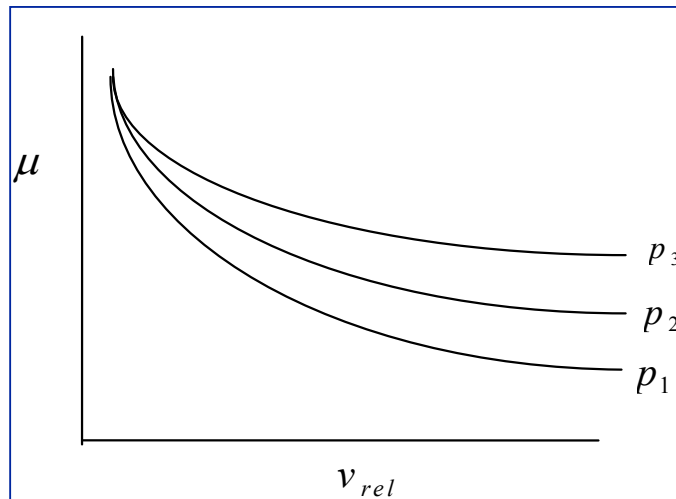
WARNING: Please note that the FS=-1.0 and FS=-2.0 options apply only to contact types:

SINGLE\_SURFACE,  
AUTOMATIC\_GENERAL,  
AUTOMATIC\_SINGLE\_SURFACE,  
AUTOMATIC\_NODES\_TO\_SURFACE,  
AUTOMATIC\_SURFACE\_TO\_SURFACE,  
AUTOMATIC\_ONE\_WAY\_SURFACE\_TO\_SURFACE,  
ERODING\_SINGLE\_SURFACE.

EQ.2: For contact type ONE\_WAY\_SURFACE\_TO\_SURFACE, the dynamic coefficient of friction points to the table, see DEFINE\_TABLE (The table ID is given by FD below.), giving the coefficient of friction as a function of the relative velocity and pressure. This option must be used in combination with the thickness offset option. See Figure 10.1.

VARIABLE	DESCRIPTION
FD	<p>Dynamic coefficient of friction. The frictional coefficient is assumed to be dependent on the relative velocity <math>v_{rel}</math> of the surfaces in contact</p> $\mu_c = FD + (FS - FD)e^{-DC v_{rel} }$ <p>Give table ID if FS=2. If FS=-2 and more than one friction table is defined, FD is used to specify friction table to be used.</p> <p><b>Note:</b> For the special contact option "TIED_SURFACE_TO_SURFACE_FAILURE" only, the variables FS and FD act as failure stresses, i.e.,</p> <p>failure occurs if <math>\left[ \frac{\max(0.0, \sigma_{normal})}{FS} \right]^2 + \left[ \frac{\sigma_{shear}}{FD} \right]^2 - 1 &gt; 0</math> where <math>\sigma_{normal}</math> and <math>\sigma_{shear}</math> are the interface normal and shear stresses.</p>
FS	Normal tensile stress at failure
FD	Shear stress at failure
DC	<p>Exponential decay coefficient. The frictional coefficient is assumed to be dependent on the relative velocity <math>v_{rel}</math> of the surfaces in contact</p> $\mu_c = FD + (FS - FD)e^{-DC v_{rel} }$
VC	<p>Coefficient for viscous friction. This is necessary to limit the friction force to a maximum. A limiting force is computed <math>F_{lim} = VC \cdot A_{cont} \cdot A_{cont}</math> being the area of the segment contacted by the node in contact.</p> <p>The suggested value for VC is to use the yield stress in shear <math>VC = \frac{\sigma_o}{\sqrt{3}}</math> where <math>\sigma_o</math> is the yield stress of the contacted material.</p>
VDC	<p>Viscous damping coefficient in percent of critical. In order to avoid undesirable oscillation in contact, e.g., for sheet forming simulation, a contact damping perpendicular to the contacting surfaces is applied.</p> <p>Damping coefficient <math>\xi = \frac{VDC}{100} \xi_{wd}</math>, eg VDC = 20. <math>\xi_{crit}</math> is determined in the following fashion by LS-DYNA.</p>

VARIABLE	DESCRIPTION
PENCHK	Small penetration in contact search option. If the slave node penetrates more than the segment thickness times the factor XPENE, see *CONTROL_CONTACT, the penetration is ignored and the slave node is set free. The thickness is taken as the shell thickness if the segment belongs to a shell element or it is taken as 1/20 of its shortest diagonal if the segment belongs to a solid element. This option applies to the surface-to-surface contact algorithms: See Table 10.1 for contact types and more details.
BT	Birth time (contact surface becomes active at this time). EQ.0: Birth time is inactive, i.e., contact is always active LT.0: Birth time,  BT , is active during dynamic relaxation, and after dynamic relaxation contact is always active GT.0: If DT>0, birth time applies both during and after dynamic relaxation.
DT	Death time (contact surface is deactivated at this time). LT.0: Birth time,  BT , is active after dynamic relaxation is completed and DT= DT . During dynamic relaxation, the contact is inactive. EQ.0: DT defaults to 1.E+20.



**Figure 10.1.** Friction coefficient,  $\mu$ , can be a function of relative velocity and pressure. Specify a flag for the static coefficient of friction, FS, and a table ID for the dynamic coefficient. This option only works with ONE\_WAY\_SURFACE\_TO\_SURFACE with thickness offsets.

**Card 3****This card is mandatory for all contact types.**

Card 3	1	2	3	4	5	6	7	8
Variable	SFS	SFM	SST	MST	SFST	SFMT	FSF	VSF
Type	F	F	F	F	F	F	F	F
Default	1.	1.	element thickness	element thickness	1.	1.	1.	1.

**VARIABLE****DESCRIPTION**

SFS	Scale factor on default slave penalty stiffness when SOFT=0 or SOFT=2, see also *CONTROL_CONTACT.
SFM	Scale factor on default master penalty stiffness when SOFT=0 or SOFT=2, see also *CONTROL_CONTACT.
SST	Optional thickness for slave surface (overrides true thickness). This option applies to contact with shell and beam elements. SST has no bearing on the actual thickness of the elements; it only affects the location of the contact surface. For the *CONTACT_TIED_.. options, SST and MST below can be defined as negative values, which will cause the determination of whether or not a node is tied to depend only on the separation distance relative to the absolute value of these thicknesses. More information is given under <u>General Remarks on *CONTACT</u> following Optional Card D.
MST	Optional thickness for master surface (overrides true thickness). This option applies only to contact with shell elements. True thickness is the element thickness of the shell elements. For the TIED options see SST above.
SFST	Scale factor for slave surface thickness (scales default thickness). This option applies to contact with shell and beam elements. SFST has no bearing on the actual thickness of the elements; it only affects the location of the contact surface. For the mortar contact, see general remarks.
SFMT	Scale factor for master surface thickness (scales default thickness). This option applies only to contact with shell elements. SFMT has no bearing on the actual thickness of the elements; it only affects the location of the contact surface.

---

<u>VARIABLE</u>	<u>DESCRIPTION</u>
FSF	Coulomb friction scale factor. The Coulomb friction value is scaled as $\mu_{sc} = FSF \cdot \mu_c$ , see above.
VSF	Viscous friction scale factor. If this factor is defined then the limiting force becomes: $F_{lim} = VSF \cdot VC \cdot A_{cont}$ , see above.

### Remarks:

The variables FSF and VSF above can be overridden segment by segment on the \*SET\_SEGMENT or \*SET\_SHELL\_OPTION cards for the **slave surface only** as A3 and A4, and for the **master surface only** as A1 and A2. See \*SET\_SEGMENT and \*SET\_SHELL\_OPTION.



**Card 4**

This Card is mandatory for:

- \*CONTACT\_AUTOMATIC\_SURFACE\_TO\_SURFACE\_TIEBREAK\_{OPTION}
- \*CONTACT\_AUTOMATIC\_ONE\_WAY\_SURFACE\_TO\_SURFACE\_TIEBREAK\_{OPTION}

If the response parameter OPTION below is set to 9, three damping constants can be defined for the various failure modes. To do this, set the keyword option to

**DAMPING**

Card 4            1            2            3            4            5            6            7            8

Variable	OPTION	NFLS	SFLS	PARAM	ERATEN	ERATES	CT2CN	CN
Type	I	F	F	F	F	F	F	F
Default	required	required	required	opt=2,6,11	opt=7,9,11	opt=7,9,11	opt=9,11	

Define the following card if and only if OPTION=9 and the DAMPING option is set on the keyword card.

optional            1            2            3            4            5            6            7            8

Variable	DMP_1	DMP_2	DMP_3					
Type	F	F	F					
Default	0.0	0.0	0.0					

<b>VARIABLE</b>	<b>DESCRIPTION</b>
OPTION	<p>Response:</p> <p>EQ.-3: see 3, moments are transferred. SMP only.</p> <p>EQ.-2: see 2, moments are transferred. SMP only.</p> <p>EQ.-1: see 1, moments are transferred. SMP only.</p> <p>EQ.1: slave nodes in contact and which come into contact will permanently stick. Tangential motion is inhibited.</p> <p>EQ.2: tiebreak is active for nodes which are initially in contact. Until failure, tangential motion is inhibited. If PARAM is set to unity, (1.0) shell thickness offsets are ignored, and the orientation of the shell surfaces is required such that the outward normals point to the opposing contact surface.</p> <p>EQ.3: as 1 above but with failure after sticking.</p> <p>EQ.4: tiebreak is active for nodes which are initially in contact but tangential motion with frictional sliding is permitted.</p> <p>EQ.5: tiebreak is active for nodes which are initially in contact. Stress is limited by the yield condition described in Remark 5 below. Damage is a function of the crack width opening. The damage function is defined by a load curve which starts at unity for a crack width of zero and decays in some way to zero at a given value of the crack opening. This option can be used to represent deformable glue bonds.</p> <p>EQ.6: This option is for use with solids and thick shells only. Tiebreak is active for nodes which are initially in contact. Failure stress must be defined for tiebreak to occur. After the failure stress tiebreak criterion is met, damage is a linear function of the distance C between points initially in contact. When the distance is equal to PARAM, damage is fully developed and interface failure occurs. After failure, this option behaves as a surface-to-surface contact.</p> <p>EQ.7: Dycoss Discrete Crack Model. “_ONE_WAY_SURFACE_TO_SURFACE_TIEBREAK” definition is recommended for this option. See Remark 7.</p> <p>EQ.8: This is similar to OPTION=6 but works with offset shell elements. “_ONE_WAY_SURFACE_TO_SURFACE_TIEBREAK” definition is recommended for this option.</p> <p>EQ.9: Extension of OPTION=7. Discrete Crack Model with power law and B-K damage models. “_ONE_WAY_SURFACE_TO_SURFACE_TIEBREAK” definition is recommended for this option. See Remark 8.</p> <p>EQ.10: This is similar to OPTION=7 but works with offset shell elements. “_ONE_WAY_SURFACE_TO_SURFACE_TIEBREAK” definition is recommended for this option.</p> <p>EQ.11: This is similar to OPTION=9 but works with offset shell elements. “_ONE_WAY_SURFACE_TO_SURFACE_TIEBREAK” definition is recommended for this option.</p>

<b>VARIABLE</b>	<b>DESCRIPTION</b>
NFLS	Normal failure stress for OPTION=2, 3, 4, 6, 7, 8, 9, 10 or 11. For OPTION=5 NFLS becomes the plastic yield stress as defined in Remark 5. For OPTION=9 or 11 and NFLS<0, a load curve ID=-NFLS is referenced defining normal failure stress as a function of element size. See remarks.
SFLS	Shear failure stress for OPTION=2, 3, 6, 7, 8, 9, 10 or 11. For OPTION=4, SFLS is a frictional stress limit if PARAM=1. This frictional stress limit is independent of the normal force at the tie. For OPTION=5 SFLS becomes the load curve ID of the damage model. For OPTION=9 or 11 and SFLS<0, a load curve ID=-SFLS is referenced defining shear failure stress as a function of element size. See remarks.
PARAM	For OPTION=2, setting PARAM=1 causes the shell thickness offsets to be ignored. For OPTION=4, setting PARAM=1 causes SFLS to be a frictional stress limit. For OPTION=6 or 8, PARAM is the critical distance, CCRIT, at which the interface failure is complete. For OPTION=7 or 10 PARAM is the friction angle in degrees. For OPTION=9 or 11, it is the exponent in the damage model. A positive value invokes the power law, while a negative one, the B-K model. See MAT_138 for additional details.
ERATEN	For OPTION=7,9,10,11 only. Normal energy release rate (stress*length) used in damage calculation, see Lemmen and Meijer [2001].
ERATES	For OPTION=7,9,10,11 only. Shear energy release rate (stress*length) used in damage calculation, see Lemmen and Meijer [2001].
CT2CN	The ratio of the tangential stiffness to the normal stiffness for OPTION=9,11. The default is 1.0.
CN	Normal stiffness (stress/length) for OPTION=9,11. If CN is not given explicitly, penalty stiffness is used (default). This optional stiffness should be used with care, since contact stability can get affected. A warning message with a recommended time step is given initially.
DMP_1	Mode I damping force per unit velocity per unit area.
DMP_2	Mode II damping force per unit velocity per unit area.
DMP_3	Mode III damping force per unit velocity per unit area.

**Remarks:**

1. After failure, this contact option behaves as a surface-to-surface contact with thickness offsets. After failure, no interface tension is possible.
2. The soft constraint option with SOFT=2 is not implemented for the tiebreak option.
3. For OPTION = 2, 3, and 6 the tiebreak failure criterion has normal and shear components:

$$\left( \frac{|\sigma_n|}{\text{NFLS}} \right)^2 + \left( \frac{|\sigma_s|}{\text{SFLS}} \right)^2 \geq 1$$

4. For OPTION = 4, the tiebreak failure criterion has only a normal stress component:

$$\frac{|\sigma_n|}{\text{NFLS}} \geq 1$$

5. For OPTION = 5, the stress is limited by a perfectly plastic yield condition. For ties in tension, the yield condition is

$$\frac{\sqrt{\sigma_n^2 + 3|\sigma_s|^2}}{\text{NLFS}} \leq 1$$

For ties in compression, the yield condition is

$$\frac{\sqrt{3|\sigma_s|^2}}{\text{NLFS}} \leq 1$$

The stress is also scaled by the damage function which is obtained from the load curve. For ties in tension, both normal and shear stress are scaled. For ties in compression, only shear stress is scaled.

6. For OPTION = 6 or 8, damage initiates when the stress meets the failure criterion. The stress is then scaled by the damage function. Assuming no load reversals, the energy released due to the failure of the interface is approximately  $0.5*S*CCRIT$ , where

$$S = \sqrt{\max(\sigma_n, 0)^2 + |\sigma_s|^2}$$

at the initiation of damage. This interface may be used for simulating crack propagation. For the energy release to be correct, the contact penalty stiffness must be much larger than

$$\frac{\text{MIN}(\text{NFLF}, \text{SFLS})}{\text{CCRIT}}$$

7. OPTION = 7 or 10 is the Dycoss Discrete Crack Model as described in Lemmen and Meijer [2001]. The relation for the crack initiation is given as

$$\left( \frac{\max(\sigma_n, 0)}{NFLS} \right)^2 + \left( \frac{\sigma_s}{SFLS (1 - \sin(\text{PARAM}) \min(0, \sigma_n))} \right) = 1$$

8. OPTION = 9 or 11 is an extension of the Dycoss Discrete Crack Model based on the fracture model in the cohesive material model \*MAT\_COHESIVE\_MIXED\_MODE, where the model is described in detail. Failure stresses/peak tractions NFLS and/or SFLS can be defined as functions of characteristic element length (square root of master segment area) via load curve. This option is useful to get nearly the same global responses (e.g. load-displacement curve) with coarse meshes compared to a fine mesh solution. In general, lower peak tractions are needed for coarser meshes. See also \*MAT\_138.

**This Card 4 is mandatory for:**

**\*CONTACT\_CONSTRAINT\_NODES\_TO\_SURFACE**  
**\*CONTACT\_CONSTRAINT\_SURFACE\_TO\_SURFACE**

Card 4            1            2            3            4            5            6            7            8

Variable	KPF								
Type	F								
Default	0.0								

<u>VARIABLE</u>	<u>DESCRIPTION</u>
KPF	Kinematic partition factor for constraint: EQ. 0.0: fully symmetric treatment. EQ.1.0: one way treatment with slave nodes constrained to master surface. Only the slave nodes are checked against contact. EQ.-1.0: one way treatment with master nodes constrained to slave surface. Only the master nodes are checked against contact.

# \*CONTACT

\*CONTACT\_OPTION1\_{OPTION2}...

This Card 4 is mandatory for:

\*CONTACT\_DRAWBEAD

\*CONTACT\_DRAWBEAD\_INITIALIZE

Card 4            1            2            3            4            5            6            7            8

Variable	LCIDRF	LCIDNF	DBDTH	DFSC	NUMINT	DBPID	ELOFF	
Type	I	I	F	F	I	I	I	
Default	required	none	0.0	1.0	0	0	0	

If the option INITIALIZE is active, then define the following card to initialize the plastic strain and thickness of elements that pass under the drawbead.

Optional        1            2            3            4            5            6            7            8

Variable	LCEPS	TSCALE	LCEPS2	OFFSET				
Type	I	F	I	F				
Default	required	1.0	optional	optional				

## VARIABLE

## DESCRIPTION

LCIDRF

If LCIDRF is positive then it defines the load curve ID giving the bending component of the restraining force,  $F_{\text{bending}}$ , per unit draw bead length as a function of displacement,  $\delta$ , see Figure 10.2. This force is due to the bending and unbending of the blank as it moves through the draw bead. The total restraining force is the sum of the bending and friction components.

If LCIDRF is negative, then the absolute value gives the load curve ID defining max bead force versus normalized draw bead length. The abscissa values are between zero and 1 and are the normalized draw bead length. The ordinate gives the maximum allowed draw bead, retaining force when the bead is in the fully closed position. If the draw bead is not fully closed, linear interpolation is used to compute the draw bead force.

VARIABLE	DESCRIPTION
LCIDNF	Load curve ID giving the normal force per unit draw bead length as a function of displacement, $\delta$ , see Figure 10.2. This force is due to the bending of the blank into the draw bead as the binder closes on the die and represents a limiting value. The normal force begins to develop when the distance between the die and binder is less than the draw bead depth. As the binder and die close on the blank this force should diminish or reach a plateau, see the Remarks section.
DBDTH	Draw bead depth, see Figure 10.2. Necessary to determine correct $\delta$ displacement from contact displacements.
DFSCL	Scale factor for load curve. Default=1.0. This factor scales load curve ID, LCIDRF above.
NUMINT	<p>Number of equally spaced integration points along the draw bead:            EQ.0: Internally calculated based on element size of elements that interact with draw bead.</p> <p>This is necessary for the correct calculation of the restraining forces. More integration points may increase the accuracy since the force is applied more evenly along the bead.</p>
DBPID	Optional part ID for the automatically generated truss elements for the draw bead display in the post-processor. If undefined LS-DYNA assigns a unique part ID.
ELOFF	Option to specify and element ID offset for the truss elements that are automatically generated for the draw bead display. If undefined LS-DYNA chooses a unique offset.
LCEPS	Load curve ID defining the plastic strain versus the parametric coordinate through the shell thickness. The parametric coordinate should be defined in the interval between -1 and 1 inclusive. The value of plastic strain at the integration point is interpolated from this load curve. If the plastic strain at an integration point exceeds the value of the load curve at the time initialization occurs, the plastic strain at the point will remain unchanged.
TSCALE	Scale factor that multiplies the shell thickness as the shell element moves under the draw bead.

---

<u>VARIABLE</u>	<u>DESCRIPTION</u>
LCEPS2	Optional load curve ID defining the plastic strain versus the parametric coordinate through the shell thickness, which is used after an element has traveled a distance equal to OFFSET. The parametric coordinate should be defined in the interval between -1 and 1 inclusive. The value of plastic strain at the integration point is interpolated from this load curve. If the plastic strain at an integration point exceeds the value of the load curve at the time initialization occurs, the plastic strain at the point will remain unchanged. Input parameters LCEPS2 and OFFSET provides a way to model the case where a material moves under two draw beads. In this latter case the curve would be the sum of the plastic strains generate by moving under two consecutive beads.
OFFSET	If the center of an element has moved a distance equal to OFFSET, the load curve ID, LCEPS2 is used to reinitialize the plastic strain. The TSCALE scale factor is also applied.

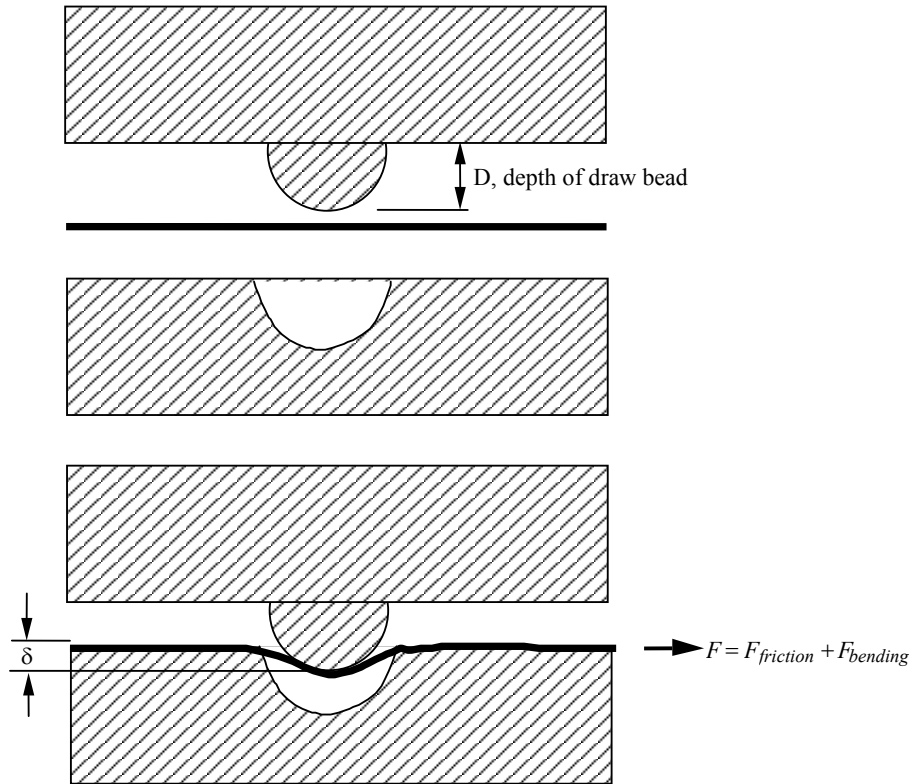
**Remarks:**

The draw bead is defined three ways:

1. A consecutive list of slave nodes that lie along the bead.
2. A part ID of a beam that lies along the draw bead.
3. A part set ID of beams that lie along the draw bead.

For straight draw beads only two nodes or a single beam need to be defined, i.e., one at each end, but for curved beads sufficient nodes or beams are required to define the curvature of the bead geometry. When beams are used to define the bead, with the exception of the first and last node, each node must connect with two beam elements. This requirement means that the number of slave nodes equals the number of beam elements plus one. The integration points along the bead are equally spaced and are independent of the nodal spacing used in the definition of the draw bead. By using the capability of tying extra nodes to rigid bodies (see \*CONSTRAINED\_EXTRA\_NODES or \*CONSTRAINED\_RIGID\_BODIES) the draw bead nodal points do not need to belong to the element connectivities of the die and binder. The blank makes up the master surface. **IT IS HIGHLY RECOMMENDED TO DEFINE A BOXID AROUND THE DRAWBEAD TO LIMIT THE SIZE OF THE MASTER SURFACE CONSIDERED FOR THE DRAW BEAD. THIS WILL SUBSTANTIALLY REDUCE COST AND MEMORY REQUIREMENTS.**





**Figure 10.2.** Draw bead contact model defines a resisting force as a function of draw bead displacement. The friction force is computed from the normal force in the draw bead and the given friction coefficient

# \*CONTACT

\*CONTACT\_OPTION1\_{OPTION2}...

This Card 4 is mandatory for:

\*CONTACT\_ERODING\_NODES\_TO\_SURFACE  
\*CONTACT\_ERODING\_SINGLE\_SURFACE  
\*CONTACT\_ERODING\_SURFACE\_TO\_SURFACE

Card 4            1            2            3            4            5            6            7            8

Variable	ISYM	EROSOP	IADJ					
Type	I	I	I					
Default	0	0	0					

## VARIABLE

## DESCRIPTION

ISYM	Symmetry plane option: EQ.0: off, EQ.1: do not include faces with normal boundary constraints (e.g., segments of brick elements on a symmetry plane). This option is important to retain the correct boundary conditions in the model with symmetry.
EROSOP	Erosion/Interior node option: EQ.0: only exterior boundary information is saved, EQ.1: storage is allocated so that eroding contact can occur. Otherwise, no contact is assumed after erosion of the corresponding element.
IADJ	Adjacent material treatment for solid elements: EQ.0: solid element faces are included only for free boundaries, EQ.1: solid element faces are included if they are on the boundary of the material subset. This option also allows the erosion within a body and the subsequent treatment of contact.

## Remarks:

Eroding contact may control the timestep (see ECDT in \*CONTROL\_CONTACT). For ERODING\_NODES\_TO\_SURFACE, define the slave side using a node set, not a part ID or part set ID.

**This Card 4 is mandatory for:**

- \*CONTACT\_NODES\_TO\_SURFACE\_INTERFERENCE
- \*CONTACT\_ONE\_WAY\_SURFACE\_TO\_SURFACE\_INTERFERENCE
- \*CONTACT\_SURFACE\_TO\_SURFACE\_INTERFERENCE

Purpose: This contact option provides a means of modeling parts which are shrink fitted together and are, therefore, prestressed in the initial configuration. This option turns off the nodal interpenetration checks (which changes the geometry by moving the nodes to eliminate the interpenetration) at the start of the simulation and allows the contact forces to develop to remove the interpenetrations. The load curves defined in this section scale the interface stiffness constants such that the stiffness can increase slowly from zero to a final value with effect that the interface forces also increase gradually to remove the overlaps.

Card 4            1            2            3            4            5            6            7            8

Variable	LCID1	LCID2						
Type	I	I						
Default	0	0						

---

**VARIABLE**


---

**DESCRIPTION**

LCID1	Load curve ID which scales the interface stiffness during dynamic relaxation. This curve must originate at (0,0) at time=0 and gradually increase.
LCID2	Load curve ID which scales the interface stiffness during the transient calculation. This curve generally has a constant value of unity for the duration of the calculation if LCID1 is defined. If LCID1=0, this curve must originate at (0,0) at time=0 and gradually increase to a constant value.

**Remarks:**

Extreme caution must be used with this option. First, shell thickness offsets are taken into account for deformable shell elements. Furthermore, SEGMENT ORIENTATION FOR SHELL ELEMENTS AND INTERPENETRATION CHECKS ARE SKIPPED. Therefore, it is necessary in the problem setup to ensure that all contact segments which belong to shell elements are properly oriented, i.e., the outward normal vector of the segment based on the right hand rule relative to the segment numbering, must point to the opposing contact surface; consequently,

automatic contact generation should be avoided for parts composed of shell elements unless automatic generation is used on the slave side of a nodes to surface interface.

**This Card 4 is mandatory for:**

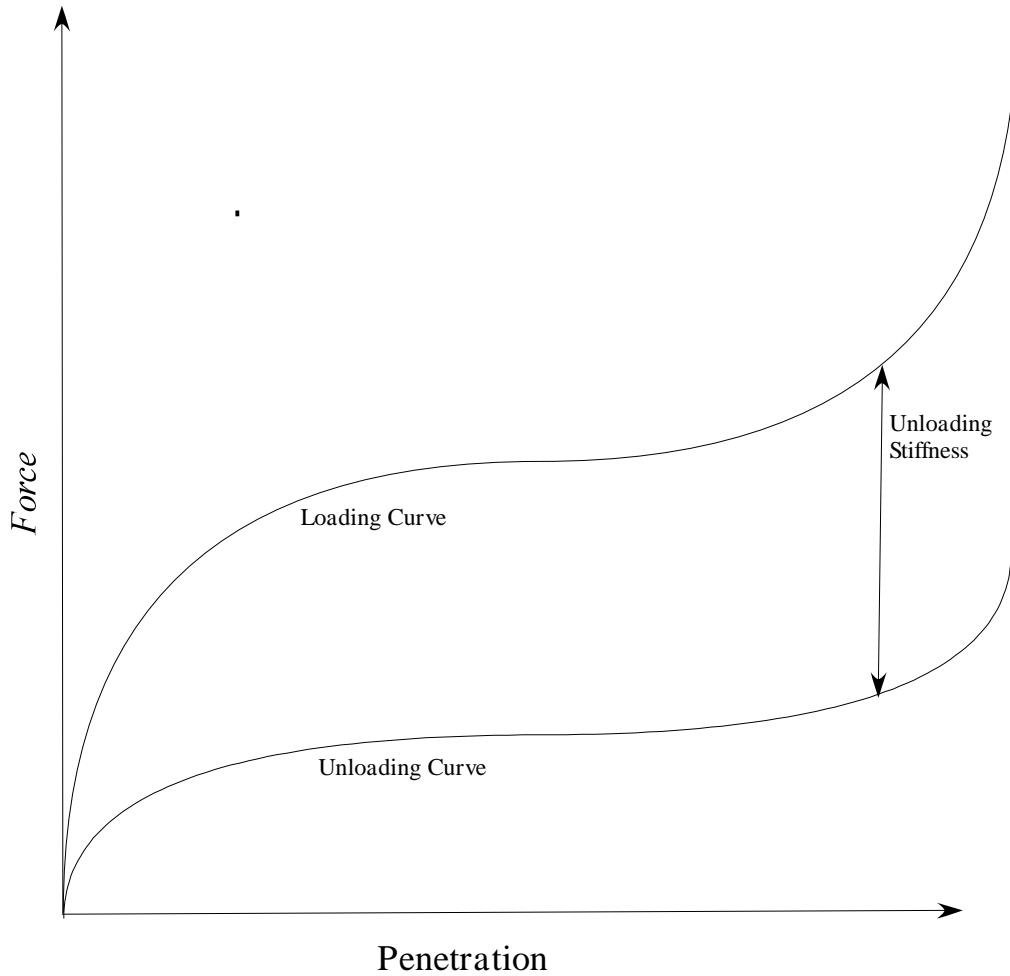
**\*CONTACT\_RIGID\_NODES\_TO\_RIGID\_BODY**  
**\*CONTACT\_RIGID\_BODY\_ONE\_WAY\_TO\_RIGID\_BODY**  
**\*CONTACT\_RIGID\_BODY\_TWO\_WAY\_TO\_RIGID\_BODY**

Card 4            1            2            3            4            5            6            7            8

Variable	LCID	FCM	US		LCDC	DSF	UNLCID	
Type	I	I	F		I	F	I	
Default	required	required	from LCID		optional	0.0	optional	

<u>VARIABLE</u>	<u>DESCRIPTION</u>
LCID	Load curve ID giving force versus penetration behavior for RIGID_contact. See also the definition of FCM below.
FCM	Force calculation method for RIGID_contact: EQ.1: Load curve gives total normal force on surface versus maximum penetration of any node (RIGID_BODY_ONE_WAY only). EQ.2: Load curve gives normal force on each node versus penetration of node through the surface (all RIGID_contact types). EQ.3: Load curve gives normal pressure versus penetration of node through the surface (RIGID_BODY_TWO_WAY and RIGID_BODY_ONE_WAY only). EQ.4: Load curve gives total normal force versus maximum soft penetration. In this case the force will be followed based on the original penetration point. (RIGID_BODY_ONE_WAY only).
US	Unloading stiffness for RIGID_contact. The default is to unload along the loading curve. This should be equal to or greater than the maximum slope used in the loading curve.
LCDC	Load curve ID giving damping coefficient (DC) versus penetration velocity. The damping force FD is then: $FD = DSF * DC * velocity$ .

<b>VARIABLE</b>	<b>DESCRIPTION</b>
DSF	Damping scaling factor.
UNLCID	Optional load curve ID giving force versus penetration behavior for RIGID_BODY_ONE_WAY contact. This option requires the definition of the unloading stiffness, US. See Figure 10.3.



**Figure 10.3.** Behavior if an unloading curve is defined

**This Card 4 is mandatory for:**

**\*CONTACT\_TIEBREAK\_NODES\_TO\_SURFACE and  
\*CONTACT\_TIEBREAK\_NODES\_ONLY**

Card 4            1            2            3            4            5            6            7            8

Variable	NFLF	SFLF	NEN	MES				
Type	F	F	F	F				
Default	required	required	2.	2.				

**VARIABLE****DESCRIPTION**

NFLF            Normal failure force. Only tensile failure, i.e., tensile normal forces, will be considered in the failure criterion.

SFLF            Shear failure force

NEN            Exponent for normal force

MES            Exponent for shear force. Failure criterion:

$$\left( \frac{|f_n|}{NFLF} \right)^{NEN} + \left( \frac{|f_s|}{SFLF} \right)^{MES} \geq 1$$

Failure is assumed if the left side is larger than 1.  $f_n$  and  $f_s$  are the normal and shear interface force.

**Remarks:**

These attributes can be overridden node by node on the \*SET\_NODE\_option cards.

Both NFLF and SFLF must be defined. If failure in only tension or shear is required then set the other failure force to a large value (1E+10).

After failure, contact\_tiebreak\_nodes\_to\_surface behaves as a nodes-to-surface contact with no thickness offsets (no interface tension possible) whereas the contact\_tiebreak\_nodes\_only stops acting altogether. Prior to failure, the two contact types behave identically.

This Card 4 is mandatory for:

**\*CONTACT\_TIEBREAK\_SURFACE\_TO\_SURFACE and  
\*CONTACT\_TIEBREAK\_SURFACE\_TO\_SURFACE\_ONLY**

Card 4            1            2            3            4            5            6            7            8

Variable	NFLS	SFLS	TBLCID	THKOFF				
Type	F	F	I	I				
Default	required	required	0	0				

**VARIABLE****DESCRIPTION**

NFLS            Tensile failure stress. See remark below.

SFLS            Shear failure stress. Failure criterion

$$\left( \frac{|\sigma_n|}{\text{NFLS}} \right)^2 + \left( \frac{|\sigma_s|}{\text{SFLS}} \right)^2 \geq 1$$

TBLCID            Optional load curve number defining the resisting stress versus gap opening for the post failure response. This can be used to model the failure of adhesives.

THKOFF            Thickness offsets are considered if THKOFF=1. If shell offsets are included in the meshed geometry, this option is highly recommended since segment orientation can be arbitrary and the contact surfaces can be disjoint.

**Remarks:**

The failure attributes can be overridden segment by segment on the \*SET\_SEGMENT or \*SET\_SHELL\_option cards for the **slave surface** as A1 and A2. These variables do not apply to the master surface. Both NFLS and SFLS must be defined. If failure in only tension or shear is required then set the other failure stress to a large value (1E+10). When used with shells, contact segment normals are used to establish the tension direction (as opposed to compression). Compressive stress does not contribute to the failure equation.

After failure, \*CONTACT\_TIEBREAK\_SURFACE\_TO\_SURFACE behaves as a surface-to-surface contact with no thickness offsets.

After failure, \*CONTACT\_TIEBREAK\_SURFACE\_TO\_SURFACE\_ONLY stops acting altogether. Until failure, it ties the slave nodes to the master nodes.

**This Card 4 is mandatory for:**

**\*CONTACT\_SURFACE\_TO\_SURFACE\_CONTRACTION\_JOINT**

Purpose: This contact option turns on the contraction joint model designed to simulate the effects of sinusoidal joint surfaces (shear keys) in the contraction joints of arch dams and other concrete structures. The sinusoidal functions for the shear keys are defined according to the following three methods [Solberg and Noble 2002]:

Method 1:  $\hat{g} = g - A(1 - \cos(B(s_2 - s_1)))$

Method 2:  $\hat{g} = g - 2A|\sin(B(s_2 - s_1)/2)|$

Method 3: (default)  $\hat{g} = g - \text{Acos}(Bs_2) + \text{Acos}(Bs_1)$

Where  $g$  is a gap function for contact surface,  $\hat{g}$  is gap function for the joint surface.  $A$  is key amplitude parameter, and  $B$  is key frequency parameter.  $s_1$  and  $s_2$  are referential surfaces:

$$s_1 = \mathbf{X}_{\text{surface1}} * \mathbf{T}_{\text{key}}$$

$$s_2 = \mathbf{X}_{\text{surface2}} * \mathbf{T}_{\text{key}}$$

$$\mathbf{T}_{\text{key}} = \mathbf{T}_{\text{slide}} \times \mathbf{n}$$

Where  $\mathbf{T}_{\text{slide}}$  is the free sliding direction of the keys,  $\mathbf{n}$  is the surface normal in reference.

Card 4            1            2            3            4            5            6            7            8

Variable	MTCJ	ALPHA	BETA	TSVX	TSVY	TSVZ		
Type	I	F	F	F	F	F		
Default	0	0.0	0.0	0.0	0.0	0.0		

**VARIABLE**

**DESCRIPTION**

MTCJ            The method option for the gap function,  $\hat{g}$

ALPHA           Key amplitude parameter A

BETA            Key frequency parameter B



<u>VARIABLE</u>	<u>DESCRIPTION</u>
TSVX	X component of the free sliding direction $T_{slide}$
TSVY	Y component of the free sliding direction $T_{slide}$
TSVZ	Z component of the free sliding direction $T_{slide}$

**This Card is mandatory for the THERMAL option, i.e.:**

**Reminder:** If Card 4 is required, then it must go before this thermal card. (Card 4 is required for certain contact types - see earlier in this section for the list, later in this section for details of Card 4.)

**\*CONTACT\_ ...\_THERMAL\_.....**

Thermal Card1      1          2          3          4          5          6          7          8

Variable	K	FRAD	H0	LMIN	LMAX	CHLM	BC_FLG	ALGO
Type	F	F	F	F	F	F	I	I
Default	none	none	none	none	none	1.0	0	0

<u>VARIABLE</u>	<u>DESCRIPTION</u>
K	<p>Thermal conductivity of fluid between the contact surfaces. If a gap with a thickness <math>l_{gap}</math> exists between the contact surfaces, then the conductance due to thermal conductivity between the contact surfaces is</p> $h_{cond} = \frac{K}{l_{gap}}$ <p>Note that LS- DYNA calculates <math>l_{gap}</math> based on deformation</p>

<b>VARIABLE</b>	<b>DESCRIPTION</b>
FRAD	<p>Radiation factor between the contact surfaces.</p> $f_{\text{rad}} = \frac{\sigma}{\frac{1}{\varepsilon_1} + \frac{1}{\varepsilon_2} - 1}$ <p>Where: <math>\sigma</math> = Stefan Boltzman constant  <math>\varepsilon_1</math> = emissivity of master surface  <math>\varepsilon_2</math> = emissivity of slave surface</p> <p>LS-DYNA calculates a radiant heat transfer conductance</p> $h_{\text{rad}} = f_{\text{rad}} (T_m + T_s)(T_m^2 + T_s^2)$
H0	<p>Heat transfer conductance for closed gaps. Use this heat transfer conductance for gaps in the range</p> $0 \leq l_{\text{gap}} \leq l_{\text{min}}$
LMIN	<p>Minimum gap (<math>l_{\text{min}}</math>), use the heat transfer conductance defined (H0) for gap thicknesses less than this value.</p> <p>If <math>l_{\text{min}} &lt; 0</math>, then <math>\text{abs}(l_{\text{min}})</math> is a load curve number defining <math>l_{\text{min}}</math> vs. time.</p>
LMAX	<p>No thermal contact if gap is greater than this value (<math>l_{\text{max}}</math>).</p>
CHLM	<p>Is a multiplier used on the element characteristic distance for the search routine. The characteristic length is the largest interface surface element diagonal.</p> <p>EQ.0: Default set to 1.0</p>
BC_FLAG	<p>Thermal boundary condition flag</p> <p>EQ.0: thermal boundary conditions are <b>on</b> when parts are in contact</p> <p>EQ.1: thermal boundary conditions are <b>off</b> when parts are in contact</p>
ALGO	<p>Contact algorithm type.</p> <p>EQ.0: two way contact, both surfaces change temperature due to contact</p> <p>EQ.1: one way contact, master surface does not change temperature due to contact. Slave surface does change temperature.</p>

Note that LS- DYNA calculates  $l_{\text{gap}}$  based on deformation

**Remarks:**

In summary:

$h = h_0$ , if the gap thickness is  $0 \leq l_{\text{gap}} \leq l_{\text{min}}$

$h = h_{\text{cond}} + h_{\text{rad}}$ , if the gap thickness is  $l_{\text{min}} \leq l_{\text{gap}} \leq l_{\text{max}}$

$h = 0$ , if the gap thickness is  $l_{\text{gap}} > l_{\text{max}}$

# \*CONTACT

\*CONTACT\_OPTION1\_{OPTION2}...

## \*CONTACT\_ ...\_THERMAL\_FRICTION\_ ...

WARNING: This is only implemented for the keyword \*CONTACT\_SURFACE\_TO\_SURFACE\_THERMAL\_FRICTION. Check with LSTC for information on other contact types.

This card is required if the FRICTION suffix is added to THERMAL. The keyword \*LOAD\_SURFACE\_STRESS must be used so that LS-DYNA will calculate contact pressure which is needed in the h(P) formulas. The blank (or work piece) must be defined as the slave surface in a metal forming model.

Purpose:

1. Used to define the mechanical static and dynamic friction coefficients as a function of temperature.
2. Used to define the thermal contact conductance as a function of temperature and pressure.

Card 1            1            2            3            4            5            6            7            8

Variable	LCFST	LCFDT	FORMULA	a	b	c	d	LCH
Type	I	I	I	I	I	I	I	I
Default	0	0	0	0	0.	0	0	0

**Optional Card (Required if FORMULA is a negative number, use as many cards as necessary to define -FORMULA variables)**

Card 2            1            2            3            4            5            6            7            8

Variable	UC1	UC2	UC3	UC4	UC5	UC6	UC7	UC8
Type	F	F	F	F	F	F	F	F
Default	0.0	0.0	0.0	0.0	0.0	0.0	0.0	0.0

---

**VARIABLE**

---

**DESCRIPTION**

LCFST

Load curve number for static coefficient of friction as a function of

<u>VARIABLE</u>	<u>DESCRIPTION</u>
	temperature. The load curve value multiplies the coefficient value FS.
LCFDT	Load curve number for dynamic coefficient of friction as a function of temperature. The load curve value multiplies the coefficient value FD.
FORMULA	Formula that defines the contact heat conductance as a function of temperature and pressure.
a	Load curve number for the “a” coefficient used in the formula.
b	Load curve number for the “b” coefficient used in the formula.
c	Load curve number for the “c” coefficient used in the formula.
d	Load curve number for the “d” coefficient used in the formula.
LCH	Load curve number for h. If this is defined, it will take precedence over any other definitions. GT.0: function versus time, GT.nlcur: general function(time,temp,pressure,gap) LT.0: function versus temperature.

**Remarks:**

FORMULA = 1	<p><math>h(P)</math> is defined by load curve “a”</p> <p>“a” defines a load curve for the contact conductance as a function of interface pressure.</p>
FORMULA = 2	<p><math>h(P) = a + bP + cP^2 + dP^3</math></p> <p>Although defined by load curves, the coefficients a, b, c, and d are typically constants for use in this formula. The load curves are functions of temperature.</p>
FORMULA = 3	$h(P) = \frac{\pi k_{\text{gas}}}{4\lambda} \left[ 1 + 85 \left( \frac{P}{\sigma} \right)^{0.8} \right] = \frac{a}{b} \left[ 1 + 85 \left( \frac{P}{c} \right)^{0.8} \right]$ <p>The above formula is from [Shvets and Dyban 1964].</p> <p>“a” defines a load curve for the thermal conductivity (<math>k_{\text{gas}}</math>) of the gas in the gap as a function of temperature.</p>

“b” defines a load curve for the parameter grouping  $\pi/4\lambda$ . Therefore, this load curve should be set to a constant value.  $\lambda$  is the surface roughness.

“c” defines a stress metric for deformation (e.g., yield) as a function of temperature.

FORMULA = 4

$$h(P) = a \left[ 1 - \exp \left( - b \frac{P}{c} \right) \right]^d$$

The above formula is from [Li and Sellars 1996].

“a” defines a load curve as a function of temperature.

“b” defines a load curve as a function of temperature.

“c” defines a stress metric for deformation (e.g., yield) as a function of temperature.

“d” defines a load curve as a function of temperature.

FORMULA = 5

$h(\text{gap})$  is defined by load curve “a”

“a” defines a load curve for the contact conductance as a function of the interface gap.

FORMULA < 0

This is equivalent to defining the keyword **\*USER\_INTERFACE\_CONDUCTIVITY** and the user subroutine `usrhcon` will be called for this contact interface for defining the contact heat transfer coefficient.

\*CONTACT\_ ... \_ORTHO\_FRICTION\_ ...

The following 4 cards are required if the option, ORTHO\_FRICTION is specified.

Card 1            1            2            3            4            5            6            7            8

Variable	FS1_S	FD1_S	DC1_S	VC1_S	LC1_S	OACS_S		
Type	F	F	F	F	F	I		
Default	0.	0.	0.	0.	0.	0		

Card 2            1            2            3            4            5            6            7            8

Variable	FS2_S	FD2_S	DC2_S	VC2_S	LC2_S			
Type	F	F	F	F	F			
Default	0.	0.	0.	0.	0.			

Card 3            1            2            3            4            5            6            7            8

Variable	FS1_M	FD1_M	DC1_M	VC1_M	LC1_M	OACS_M		
Type	F	F	F	F	F	I		
Default	0.	0.	0.	0.	0.	0		

Card 4            1            2            3            4            5            6            7            8

Variable	FS2_M	FD2_M	DC2_M	VC2_M	LC2_M			
Type	F	F	F	F	F			
Default	0.	0.	0.	0.	0.			

**VARIABLE**

**DESCRIPTION**

FSn\_S or M

Static coefficient of friction in the local n orthotropic direction for the slave (S) or master (M) surface. The frictional coefficient is assumed to be dependent on the relative velocity  $v_{rel}$  of the surfaces in contact  $\mu_c = FD + (FS - FD)e^{-DC|v_{rel}|}$  where the direction and surface are left off for clarity. The ORTHO\_FRICTION option applies only to contact types:

AUTOMATIC\_SURFACE\_TO\_SURFACE,  
AUTOMATIC\_ONE\_WAY\_SURFACE\_TO\_SURFACE,

when they are defined by segment sets. Each segment in the set requires the specification of an offset angle in degrees from the 1-2 side which locates the 1 direction. The offset angle is input as the first attribute of the segment in \*SET\_SEGMENT. The transverse direction, 2, is in the plane of the segment and is perpendicular to the 1 direction.

FDn\_S or M

Dynamic coefficient of friction in the local n orthotropic direction.

DCn\_S or M

Exponential decay coefficient for the local n direction.

VCn\_S or M

Coefficient for viscous friction in the local n direction. See the description for VC for mandatory Card 2 above.

LCn\_S or M

The table ID of a two dimensional table, see \*DEFINE\_TABLE or \*DEFINE\_TABLE\_2D, giving the friction coefficient in the local n direction as a function of the relative velocity and interface pressure. In this case, each curve in the table definition defines the coefficient of friction versus the interface pressure corresponding to a particular value of the relative velocity.



<u>VARIABLE</u>	<u>DESCRIPTION</u>
OACS_S or M	If the default value, 0, is active, the frictional forces acting on a node sliding on a segment are based on the local directions of the segment. If OACS is set to unity, 1, the frictional forces acting on a node sliding on a segment are based on the local directions of the sliding node.

### Optional Card A

**Reminder:** If Card 4 is required, then it must go before this optional card. (Card 4 is required for certain contact types - see earlier in this section for the list, later in this section for details of Card 4.)

Optional Card A	1	2	3	4	5	6	7	8
Variable	SOFT	SOFSC	LCIDAB	MAXPAR	SBOPT	DEPTH	BSORT	FRCFRQ
Type	I	F	I	F	F	I	I	I
Default	0	.1	0	1.025.	0.	2	10-100	1
Remarks			type a13					

<u>VARIABLE</u>	<u>DESCRIPTION</u>
SOFT	<p>Soft constraint option:</p> <p>EQ.0: penalty formulation,  EQ.1: soft constraint formulation,  EQ.2: segment-based contact.  EQ.4: constraint approach for FORMING contact option.</p> <p>The soft constraint may be necessary if the material constants of the elements which make up the surfaces in contact have a wide variation in the elastic bulk moduli. In the soft constraint option, the interface stiffness is based on the nodal mass and the global time step size. This method of computing the interface stiffness will typically give much higher stiffness value than would be obtained by using the bulk modulus; therefore, this method the preferred approach when soft foam materials interact with metals. See the remark below for the segment-based penalty formulation.</p>

<b>VARIABLE</b>	<b>DESCRIPTION</b>
SOFSCAL	Scale factor for constraint forces of soft constraint option (default=.10). Values greater than .5 for single surface contact and 1.0 for a one-way treatment are inadmissible.
LCIDAB	Load curve ID defining airbag thickness as a function of time for type a13 contact (*CONTACT_AIRBAG_SINGLE_SURFACE).
MAXPAR	<p>Maximum parametric coordinate in segment search (values 1.025 and 1.20 recommended). Larger values can increase cost. If zero, the default is set to 1.025 for most contact options. Other defaults are:</p> <p>EQ.1.006:SPOTWELD,  EQ.1.006:TIED_SHELL_..._CONSTRAINED_OFFSET,  EQ.1.006:TIED_SHELL_..._OFFSET,  EQ.1.006:TIED_SHELL_..._:BEAM_OFFSET,  EQ.1.100:AUTOMATIC_GENERAL</p> <p>This factor allows an increase in the size of the segments which may be useful at sharp corners. For the SPOTWELD and ..._OFFSET options larger values can sometimes lead to numerical instabilities; however, a larger value is sometimes necessary to ensure that all nodes of interest are tied.</p>
SBOPT	<p>Segment-based contact options (SOFT=2).</p> <p>EQ.0: defaults to 2.  EQ.1: pinball edge-edge contact (not recommended)  EQ.2: assume planer segments (default)  EQ.3: warped segment checking  EQ.4: sliding option  EQ.5: do options 3 and 4</p>
DEPTH	<p>Search depth in automatic contact. Value of 1 is sufficiently accurate for most crash applications and is much less expensive. LS-DYNA for improved accuracy sets this value to 2. If zero, the default is set to 2.</p> <p>LT.0:  DEPTH  is the load curve ID defining searching depth versus time. (not available when SOFT=2)</p> <p>See remarks below for segment-based contact (SOFT=2) options controlled by DEPTH.</p>
BSORT	<p>Number of cycles between bucket sorts. Values of 25 and 100 are recommended for contact types 4 and 13 (SINGLE_SURFACE), respectively. Values of 10-15 are okay for the surface to surface and node to surface contact. If zero, LS-DYNA determines the interval.</p> <p>LT.0:  BSORT  load curve ID defining bucket sorting frequency versus time.</p>

VARIABLE	DESCRIPTION
FRFCRQ	<p>Number of cycles between contact force updates for penalty contact formulations. This option can provide a significant speed-up of the contact treatment. If used, values exceeding 3 or 4 are dangerous. Considerable care must be exercised when using this option, as this option assumes that contact does not change FRFCRQ cycles.</p> <p>EQ.0: FRFCRQ is set to 1 and force calculations are performed each cycle-strongly recommended.</p>

**Remarks:**

Setting SOFT=1 or 2 on optional contact card A will cause the contact stiffness to be determined based on stability considerations, taking into account the time step and nodal masses. This approach is generally more effective for contact between materials of dissimilar stiffness or dissimilar mesh densities.

SOFT=2 is for general shell and solid element contact. This option is available for all SURFACE\_TO\_SURFACE, ONE\_WAY\_SURFACE\_TO\_SURFACE, and SINGLE\_SURFACE options including eroding and airbag contact. When the AUTOMATIC option is used, orientation of shell segment normals is automatic. When the AUTOMATIC option is not used, the segment or element orientations are used as input. The segment-based penalty formulation contact algorithm checks for segments vs. segment penetration rather than node vs. segment. After penetrating segments are found, an automatic judgment is made as to which is the master segment, and penalty forces are applied normal to that segment. The user may override this automatic judgment by using the ONE\_WAY options in which case the master segment normals are used as input by the user. All parameters on the first three cards are active except for VC, and VSF. On optional card A, some parameters have different meanings than they do for the default contact.

For SOFT=2, the SBOPT parameter on optional card A controls several options. The pinball edge-to-edge checking is not recommended and is included only for back compatibility. For edge-to-edge checking setting DEPTH=5 is recommended instead (see below). The warped segment option more accurately checks for penetration of warped surfaces. The sliding option uses neighbor segment information to improve sliding behavior. It is primarily useful for preventing segments from incorrectly catching nodes on a sliding surface.

For SOFT=2, the DEPTH parameter controls several additional options for segment based contact. When DEPTH=2 (default), surface penetrations measured at nodes are checked. When DEPTH=3, surface penetration may also be measured at the edge. This option is more accurate than DEPTH=2, and is good for a wide variety of simulations, but does not check for edge-to-edge penetration. When DEPTH=5, both surface penetrations and edge-to-edge penetration is checked. When DEPTH=13, the penetration checking is the same as for DEPTH=3, but the code has been tuned to better conserve energy. When DEPTH=23, the penetration checking is similar to DEPTH=3, but a new algorithm is used to try to improve robustness. The airbag contact has two additional options, DEPTH=1 and 4. DEPTH=4 activates additional airbag logic that uses

neighbor segment information when judging if contact is between interior or exterior airbag surfaces. This option is not recommended and is maintained only for backward compatibility. Setting DEPTH=1 suppresses all airbag logic.

For SOFT=2 contact, only the ISYM, I2D3D, SLDTHK, and SLDSTF parameters are active on optional card B. Also, the negative MAXPAR option is now incorporated into the DTSTIF option on optional card C. Data that uses the negative MAXPAR option will continue run correctly.

**Optional Card B**

**Reminder:** If Optional Card B is used, then Optional Card A must be defined. (Optional Card A may be a blank line).

Optional Card B            1            2            3            4            5            6            7            8

Variable	PENMAX	THKOPT	SHLTHK	SNLOG	ISYM	I2D3D	SLDTHK	SLDSTF
Type	F	I	I	I	I	I	F	F
Default	0	0	0	0	0	0	0	0
Remarks		Old types 3, 5, 10	Old types 3, 5, 10					

**VARIABLE**

**DESCRIPTION**

PENMAX

Maximum penetration distance for old type 3, 5, 8, 9, and 10 contact or the segment thickness multiplied by PENMAX defines the maximum penetration allowed (as a multiple of the segment thickness) for contact types a 3, a 5, a10, 13, 15, and 26. (see discussion at end of section, including Table 10.1):

EQ.0.0 for old type contacts 3, 5, and 10: Use small penetration search and value calculated from thickness and XPENE, see \*CONTROL\_CONTACT.

EQ.0.0 for contact types a 3, a 5, a10, 13, and 15: Default is 0.4, or 40 percent of the segment thickness

EQ.0.0 for contact type26: Default is 200.0 times the segment thickness

VARIABLE	DESCRIPTION
THKOPT	<p>Thickness option for contact types 3, 5, and 10:            EQ.0: default is taken from control card, *CONTROL_CONTACT,            EQ.1: thickness offsets are included,            EQ.2: thickness offsets are not included (old way).</p>
SHLTHK	<p>Define if and only if THKOPT above equals 1. Shell thickness considered in type surface to surface and node to surface type contact options, where options 1 and 2 below activate the new contact algorithms. The thickness offsets are always included in single surface and constraint method contact types:            EQ.0: thickness is not considered,            EQ.1: thickness is considered but rigid bodies are excluded,            EQ.2: thickness is considered including rigid bodies.</p>
SNLOG	<p>Disable shooting node logic in thickness offset contact. With the shooting node logic enabled, the first cycle that a slave node penetrates a master segment, that node is moved back to the master surface without applying any contact force.            EQ.0: logic is enabled (default),            EQ.1: logic is skipped (sometimes recommended for metalforming calculations or for contact involving foam materials).</p>
ISYM	<p>Symmetry plane option:            EQ.0: off,            EQ.1: do not include faces with normal boundary constraints (e.g., segments of brick elements on a symmetry plane).            This option is important to retain the correct boundary conditions in the model with symmetry. For the _ERODING_ contacts this option may also be defined on card 4.</p>
I2D3D	<p>Segment searching option:            EQ.0: search 2D elements (shells) before 3D elements (solids, thick shells) when locating segments.            EQ.1: search 3D (solids, thick shells) elements before 2D elements (shells) when locating segments.</p>
SLDTHK	<p>Optional solid element thickness. A nonzero positive value will activate the contact thickness offsets in the contact algorithms where offsets apply. The contact treatment will then be equivalent to the case where null shell elements are used to cover the brick elements. The contact stiffness parameter below, SLDSTF, may also be used to override the default value.</p>

<u>VARIABLE</u>	<u>DESCRIPTION</u>
SLDSTF	Optional solid element stiffness. A nonzero positive value overrides the bulk modulus taken from the material model referenced by the solid element.

**Optional Card C**

**Reminder:** If Optional Card C is used, then Optional Cards A and B must be defined. (Optional Cards A and B may be blank lines).

Optional Card C            1            2            3            4            5            6            7            8

Variable	IGAP	IGNORE	DPRFAC	DTSTIF			FLANGL	CID_RCF
Type	I	I	F	F			F	I
Default	1	0	0	0			0	0
Remarks			1	2				

<u>VARIABLE</u>	<u>DESCRIPTION</u>
IGAP	<p>Flag to improve implicit convergence behavior at the expense of (1) creating some sticking if parts attempt to separate and (2) possibly underreporting the contact force magnitude in the output files RCFORC and NCFORC. (IMPLICIT ONLY.)</p> <p>LT.0: Set IGAP=1 and set the distance for turning on the stiffness to (IGAP/10) times the original distance.</p> <p>EQ.1: Apply method to improve convergence (DEFAULT)</p> <p>EQ.2: Do not apply method</p> <p>GT.2: Set IGAP=1 for first IGAP-2 cycles, then set IGAP=2</p>
IGNORE	<p>Ignore initial penetrations in the *CONTACT_AUTOMATIC options.</p> <p>EQ.0: Take the default value from the fourth card of the CONTROL_CONTACT input.</p> <p>EQ.1: Allow initial penetrations to exist by tracking the initial penetrations.</p> <p>EQ.2: Allow initial penetrations to exist by tracking the initial penetrations. However, penetration warning messages are printed</p>

VARIABLE	DESCRIPTION
	with the original coordinates and the recommended coordinates of each slave node given.
DPRFAC	<p>Applies to the SOFT=2 and Mortar contact.</p> <p>Depth of penetration reduction factor for SOFT=2 contact.</p> <p>EQ.0.0: Initial penetrations are always ignored.</p> <p>GT.0.0: Initial penetrations are penalized over time.</p> <p>LE.1.0:  DPRFAC  is the load curve ID defining DPRFAC versus time.</p> <p>For the mortar contact this corresponds to initial contact pressure in interfaces with initial penetrations. See remarks below.</p>
DTSTIF	<p>Time step used in stiffness calculation for SOFT=1 and SOFT=2 contact.</p> <p>EQ.0.0: Use the initial value that is used for time integration.</p> <p>GT.0.0: Use the value specified.</p> <p>LT.-0.01 and GT. -1.0: use a moving average of the solution time step. (SOFT=2 only)</p> <p>LE.-1.0:  DTSTIF  is the ID of a curve that defines DTSTIF vs. time.</p>
FLANGL	<p>Angle tolerance in radians for feature lines option in smooth contact.</p> <p>EQ.0.0: No feature line is considered for surface fitting in smooth contact.</p> <p>GT.0.0: Any edge with angle between two contact segments bigger than this angle will be treated as feature line during surface fitting in smooth contact.</p>
CID_RCF	<p>Coordinate system ID to output RCFORC force resultants in a local system.</p>

**Remarks:**

1. DPRFAC is used only by segment based contact (SOFT=2) and Mortar Contact (see general remarks below for the latter option). By default, SOFT=2 contact measures the initial penetration between segment pairs that are found to be in contact and subtracts the measured value from the total penetration for as long as a pair of segments remains in contact. The penalty force is proportional to this modified value. This approach prevents shooting nodes, but may allow unacceptable penetration. DPRFAC can be used to decrease the measured value over time until the full penetration is penalized. Setting DPRFAC=0.01 will cause ~1% reduction in the measured value each cycle. The maximum allowable value for DPRFAC is 0.1. A small value such as 0.001 is recommended. DPRFAC does not apply to initial penetrations at the start of the calculation, only those that are measured at later times. This prevents nonphysical movement and energy growth at the start of the calculation.

The anticipated use for the load curve option is to allow the initial penetrations to be reduced at the end of a calculation if the final geometry is to be used for a subsequent analysis. To achieve this, load curve should have a y-value of zero until a time near the end of the analysis and then ramp up to a positive value such as 0.01 near the end of the analysis.

2. DTSTIF is used only by the SOFT=1 and SOFT=2 contact options. By default when the SOFT option is active, the contact uses the initial solution time step to scale the contact stiffness. If the user sets DTSIFF to a nonzero value, the inputted value will be used. Because the square of the time step appears in the denominator of the stiffness calculation, a DTSIFF value larger than the initial solution time step reduces the contact stiffness and a smaller value increases the stiffness. This option could be used when one component of a larger model has been analyzed independently and validated. When the component is inserted into the larger model, the larger model may run at a smaller time step due to higher mesh frequencies. In the full model analysis, setting DTSTIF equal to the component analysis time step for the contact interface that treats the component will cause consistent contact stiffness between the analyses.

The load curve option allows contact stiffness to be a function of time.. This should be done with care as energy will not be conserved. A special case of the load curve option is when  $|DTSTIF| = LCTM$  on \*CONTROL\_CONTACT. LCTM sets an upper bound on the solution time step. For  $|DTSTIF| = LCTM$ , the contact stiffness time step value will track LCTM whenever the LCTM value is less than the initial solution time step. If the LCTM value is greater, the initial solution time step is used. This option could be used to stiffen the contact at the end of an analysis. To achieve this, the LCTM curve should be defined such that it is larger than the solution time step until near the end of the analysis. Then the LCTM curve should ramp down below the solution time step causing it to decrease and the contact to stiffen. A load curve value of 0.1 of the calculated solution time step will cause penetrations to reduce by about 99%. To prevent shooting nodes, the rate at which the contact stiffness increases is automatically limited. Therefore, to achieve 99% reduction, the solution should be run for perhaps 1000 cycles with a small time step.

For segment based contact (SOFT=2), setting DTSTIF less than or equal to -0.01 and greater than -1.0, causes the contact stiffness will be updated based on the current solution time step. Varying the contact stiffness during a simulation can cause energy growth so this option should be used with care when extra stiffness is needed to prevent penetration and the solution time step has dropped from the initial. Because quick changes in contact stiffness can cause shooting nodes, using a moving average of the solution time step can prevent this. The value of DTSTIF determines the number of terms in the moving average where  $n=100*(-DTSTIF)$  such that  $n=1$  for  $DTSTIF=-0.01$  and  $n=100$  for  $DTSTIF=-0.999$ . Setting  $DTSTIF=-1.0$  triggers the load curve option described in the previous paragraph, so DTSIF cannot be smaller than -0.999 for this option.



**Optional Card D**

**Reminder:** If Optional Card D is used, then Optional Cards A, B and C must be defined. (Optional Cards A, B and C may be blank lines).

Optional Card D            1            2            3            4            5            6            7            8

Variable	Q2TRI	DTPCHK	SFNBR	FNLSCL	DNLSCL	TCSO	TIEDID	SHLEDG
Type	I	F	F	F	F	I	I	I
Default	0	0	0	0	0	0	0	
Remarks	1	2	3	5	5		4	

**VARIABLE****DESCRIPTION**

Q2TRI	Option to split quadrilateral contact segments into two triangles (only available when SOFT=2). EQ.0: Off (default). EQ.1: On for all slave shell segments. EQ.2: On for all master shell segments. EQ.3: On for all shell segments. EQ.4: On for all shell segments of material type 34.
DTPCHK	Time interval between shell penetration reports (only available for segment based contact) EQ.0.0: Off (default). GT.0.0: Check and report segment penetrations at time intervals equal to DTPCHK
SFNBR	Scale factor for neighbor segment contact (only available for segment based contact) EQ.0.0: Off (default). GT.0.0: Check neighbor segments for contact
FNLSCL	Scale factor for nonlinear force scaling.
TCSO	Option to consider only contact segments (not all attached elements) when computing the contact thickness for a node or segment (for SEGMENT_TO_SEGMENT contact and shell elements only) EQ.0: Off (default).

<u>VARIABLE</u>	<u>DESCRIPTION</u>
	EQ 1: Only consider segments in the contact definition
DNLSCL	Distance for nonlinear force scaling.
TIEDID	Incremental displacement update for tied contacts. (See remark 4 below.) EQ.0: Off (default). EQ.1: On
SHLEDG	Flag for assuming edge shape for shells when measuring penetration. This is available for segment based contact (see SOFT on optional card A) EQ.0: default to SHLEDG on *CONTROL_CONTACT EQ.1: Shell edges are assumed square and are flush with the nodes EQ.2: Shell edges are assumed round with radius equal to ½ shell thickness

**Remarks:**

- 1 Setting Q2TRI to a nonzero value causes quadrilateral shell segments to be split into two triangles. The contact segments only are split. The elements are not changed. This option is only available for segment based contact which is activated by setting SOFT=2.
- 2 Setting DTPCHK to a positive value causes a penetration check to be done periodically with the interval equal to DTPCHK. The check looks for shell segments that are penetrating the mid-plane of another shell segment. It does not report on penetration of thickness offsets. The penetrating pairs are reported to the message file or files for MPP. If at least one penetration is found, the total number of pairs is reported to the screen output. This option is only available for segment based contact which is activated by setting SOFT=2.
- 3 Setting SFNBR to a positive value turns on neighbor segment contact checking in segment based contact. This is helpful when a mesh folds as can happen with compression folding of an airbag. Only shell element segments are checked.
- 4 There have been several issues with tied OFFSET contacts and AUTOMATIC\_TIEBREAK contacts with offsets creating numerical round-off noise in stationary parts. By computing the interface displacements incrementally rather than using total displacements, the round-off errors that occur in single precision are eliminated. The incremental approach is available for the following contact types:

TIED\_SURFACE\_TO\_SURFACE\_OFFSET  
TIED\_NODES\_TO\_SURFACE\_OFFSET  
AUTOMATIC\_TIEBREAK

5. FNLSCS=f and DNLSCL=d scale the contact stiffness nonlinearly to provide smoother initial contact and a larger contact force as the depth of penetration exceeds DNLSCL. The stiffness k is scaled by the relation  $k = k \cdot f \sqrt{\delta / d}$  where  $\delta$  is the depth of penetration, making the penalty force proportional to the 3/2 power of the penetration depth. Adding a small amount of surface damping (e.g., VDC=10) is advised with this option. When SOFT=2 and FNLSCS is less than zero, an alternative stiffness scaling scheme is used,

$$k = k \cdot \left( \frac{0.01 \cdot f \cdot A_o}{d \cdot (d - \delta)} \right)$$

where  $A_o$  is the overlap area of segments in contact. For  $\delta$  greater than  $0.9 \cdot d$ , the stiffness is extrapolated to prevent it from going to infinity.

### Optional Card E

**Reminder:** If Optional Card E is used, then Optional Cards A, B, C and D must be defined. (Optional Cards A, B, C and D may be blank lines).

Optional Card D      1            2            3            4            5            6            7            8

Variable	SHAREC							
Type	I							
Default	0							
Remarks	1							

#### VARIABLE

#### DESCRIPTION

SHAREC

Shared constraint flag (only available for segment based contact)

EQ.0: Segments that share constraints not checked for contact.

EQ.1: Segments that share constraints are checked for contact.

## Remarks:

- 1 The SHAREC flag is a segment based contact option that allows contact checking of segment pairs that share a multi-point constraint or rigid bodies. Sharing a constraint is defined as having at least one node of each segment that belongs to the same constraint.

## General Remarks on \*CONTACT:

1. Modeling airbag interactions with structures and occupants using the actual fabric thickness, which is approximate 0.30 mm, may result in a contact breakdown that leads to inconsistent occupant behavior between different machines. Based on our experience, using a two-way automatic type contact definition, i.e., AUTOMATIC\_SURFACE\_TO\_SURFACE, between any airbag to structure/occupant interaction and setting the airbag fabric contact thickness to at least 10 times the actual fabric thickness has helped improved contact behavior and eliminates the machine inconsistencies. Due to a large stiffness difference between the airbag and the interacting materials, the soft constraint option (SOFT=1) or the segment based pinball option (SOFT=2) is recommended. It must be noted that with the above contact definition, only the airbag materials should be included in any \*AIRBAG\_SINGLE\_SURFACE definitions to avoid duplicate contact treatment that can lead to numerical instabilities.

2. TIED\_NODES\_TO\_SURFACE  
TIED\_SHELL\_EDGE\_TO\_SURFACE  
TIED\_SHELL\_EDGE\_TO\_SURFACE\_CONSTRAINED\_OFFSET  
SPOTWELD  
SPOTWELD\_WITH\_TORSION  
TIED\_SURFACE\_TO\_SURFACE

These contact definitions are based on constraint equations and will not work with rigid bodies. However, SPOTWELD\_WITH\_TORSION\_PENALTY does work with rigid bodies and tied interfaces with the offset option can be used with rigid bodies, i.e.,

TIED\_NODES\_TO\_SURFACE\_OFFSET  
TIED\_SHELL\_EDGE\_TO\_SURFACE\_OFFSET  
TIED\_SHELL\_EDGE\_TO\_SURFACE\_BEAM\_OFFSET  
TIED\_SURFACE\_TO\_SURFACE\_OFFSET

Also, it may sometimes be advantageous to use the CONSTRAINED\_EXTRA\_NODE\_OPTION instead for tying deformable nodes to rigid bodies since in this latter case the tied nodes may be an arbitrary distance away from the rigid body.

Tying will only work if the surfaces are near each other. The criteria used to determine whether a slave node is tied down is that it must be “close”. For shell elements “close” is defined as distance,  $\delta$ , less than:

$$\delta_1 = 0.60 * (thickness\_slave\_node + thickness\_master\_segment)$$

$$\delta_2 = 0.05 * \min(master\_segment\_diagonals)$$

$$\delta = \max(\delta_1, \delta_2)$$

If a node is further away it will not be tied and a warning message will be printed. For solid elements the slave node thickness is zero and the segment thickness is the element volume divided by the segment area; otherwise, the same procedure is used.

If there is a large difference in element areas between the master and slave side, the distance,  $\delta_2$ , may be too large and may cause the unexpected projection of nodes that should not be tied. This can occur during calculation when adaptive remeshing is used. To avoid this difficulty the slave and master thickness can be specified as negative values on Card 3 in which case

$$\delta = abs(\delta_1)$$

3. The contact algorithm for tying spot welds with torsion, SPOTWELD\_WITH\_TORSION, must be used with care. Parts that are tied by this option should be subjected to stiffness proportional damping of approximately ten percent, i.e., input a coefficient of 0.10. This can be defined for each part on the \*DAMPING\_PART\_STIFFNESS input. Stability problems may arise with this option if damping is not used. This comment applies also to the option \_PENALTY.

4. CONSTRAINT\_NODES\_TO\_SURFACE  
CONSTRAINT\_SURFACE\_TO\_SURFACE

These contact definitions must be used with care. The surface and the nodes which are constrained to a surface are not allowed to be used in any other CONSTRAINT\_... contact definition. If, however, contact has to be defined from both sides as in sheet metalforming, one of these contact definitions can be a CONSTRAINT\_ type; the other one could be a standard penalty type such as SURFACE\_TO\_SURFACE or NODES\_TO\_SURFACE.

5. AIRBAG\_SINGLE\_SURFACE  
AUTOMATIC\_GENERAL  
AUTOMATIC\_GENERAL\_INTERIOR  
AUTOMATIC\_NODES\_TO\_SURFACE  
AUTOMATIC\_ONE\_WAY\_SURFACE\_TO\_SURFACE  
AUTOMATIC\_SINGLE\_SURFACE  
AUTOMATIC\_SURFACE\_TO\_SURFACE  
SINGLE\_SURFACE

These contact definitions require thickness to be taken into account for rigid bodies modeled with shell elements. Therefore, care should be taken to ensure that realistic thicknesses are specified for the rigid body shells. A thickness that is too small may result in loss of contact and an unrealistically large thickness may result in a degradation

in speed during the bucket sorts as well as nonphysical behavior. The SHLTHK option on the \*CONTROL\_CONTACT card is ignored for these contact types.

6. Two methods are used in LS-DYNA for projecting the contact surface to account for shell thicknesses. The choice of methods can influence the accuracy and cost of the calculation. Segment based projection is used in contact types: See Figure 10.4

AIRBAG\_SINGLE\_SURFACE  
AUTOMATIC\_GENERAL  
AUTOMATIC\_NODES\_TO\_SURFACE  
AUTOMATIC\_ONE\_WAY\_SURFACE\_TO\_SURFACE  
AUTOMATIC\_SINGLE\_SURFACE  
AUTOMATIC\_SURFACE\_TO\_SURFACE  
FORMING\_NODES\_TO\_SURFACE  
FORMING\_ONE\_WAY\_SURFACE\_TO\_SURFACE  
FORMING\_SURFACE\_TO\_SURFACE

The remaining contact types use nodal normal projections if projections are used. The main advantage of nodal projections is that a continuous contact surface is obtained which is much more accurate in applications such as metal forming. The disadvantages of nodal projections are the higher costs due to the nodal normal calculations, difficulties in treating T-intersections and other geometric complications, and the need for consistent orientation of contact surface segments. The contact type:

SINGLE\_SURFACE

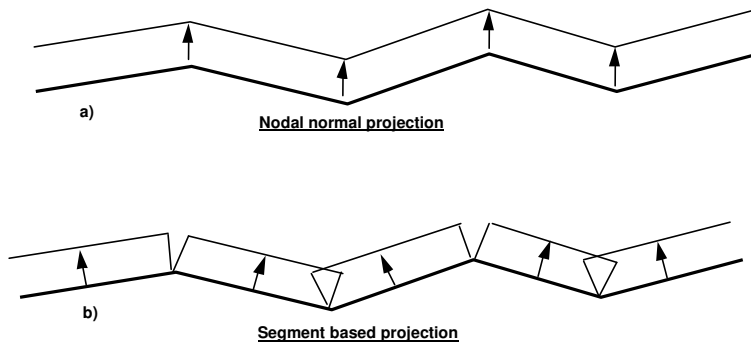
uses nodal normal projections and consequently is slower than the alternatives.

7. FORCE\_TRANSDUCER\_PENALTY  
FORCE\_TRANSDUCER\_CONSTRAINT

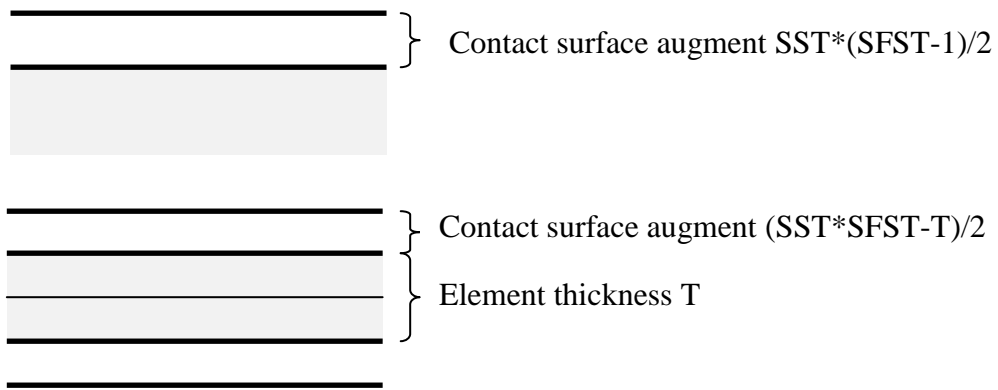
This contact allows the total contact forces applied by all contacts to be picked up. This contact does not apply any force to the model and will have no effect on the solution. Only the slave set and slave set type need be defined for this contact type. Generally, only the first three cards are defined. The force transducer option, \_PENALTY, works with penalty type contact algorithms only, i.e., it does not work with the CONSTRAINT or TIED options. For these latter options, use the \_CONSTRAINT option. If the interactions between two surfaces are needed, a master surface should be defined. In this case, only the contact forces applied between the slave and master surfaces are kept. The master surface option is only implemented for the \_PENALTY option and works only with the AUTOMATIC contact types.

8. FORMING\_... These contacts are mainly used for metal forming applications. A connected mesh is not required for the master (tooling) side but the orientation of the mesh **must** be in the same direction. These contact types are based on the AUTOMATIC type contacts and consequently the performance is better than the original two surface contacts.

9. The mortar contact, invoked by appending the suffix MORTAR to either FORMING\_SURFACE\_TO\_SURFACE, AUTOMATIC\_SURFACE\_TO\_SURFACE or AUTOMATIC\_SINGLE\_SURFACE is a segment to segment penalty based contact. For two segments on each side of the contact interface that are overlapping and penetrating, a consistent nodal force assembly taking into account the individual shape functions of the segments is performed, see Figure 10.6 for an illustration. In this respect the results with this contact may be more accurate, especially when considering contact with elements of higher order. By appending the suffix TIED to the CONTACT\_AUTOMATIC\_SURFACE\_TO\_SURFACE\_MORTAR keyword, this is treated as a tied contact interface. This contact is intended for implicit analysis in particular but is nevertheless supported for explicit analysis as well. For the AUTOMATIC contact, the contact surface can be augmented with the aid of parameters SST and SFST, and these parameters are interpreted differently for solids and shells. For shells SST corresponds to the contact thickness of the element (MST likewise for the master side), by default this is the same as the element thickness. This parameter can be scaled with aid of SFST (SFMT for the master side) to adjust the location of the contact surface, see Figure 10.5. For solids SST is by default a characteristic element size of the elements involved in the contact (MST is not used). SST is here used for determining a proper contact stiffness and can be set by the user. If so, it should correspond to a characteristic thickness in the model in order to obtain a reasonable contact stiffness. If set by the user, the contact surface can be adjusted with the aid of SFST (SFMT is not used for solids) if it is of importance to reduce the gap between parts, see Figure 10.5. This may be of interest if initial gaps results in free objects undergoing rigid body motion and thus preventing convergence in implicit. For the TIED option, SFST does not adjust the location of the contact surface, but instead modifies the distance for which a surface is tied. The criterion for tying two contact surfaces is that the distance should be less than  $0.05 * SFST * SST$ , i.e., by default it is within 5% of the element thickness (characteristic size for solids) but could be increased if desired. If initial penetrations are detected (reported in the message file) then by default these will yield an initial contact stress corresponding to this level of penetration. IGNORE>0 can be used to prevent unwanted effects of this. IGNORE=2 behaves differently than from other contacts, for this option the penetrations are not tracked but the contact surface is fixed at its initial location. In addition, for IGNORE=2, an initial contact pressure can be imposed on the interface by setting the DPRFAC parameter to the desired contact pressure. All this allows to properly eliminate any rigid body motion due to initial contact gaps.



**Figure 10.4.** Nodal normal and segment based projection is used in the contact options.



**Figure 10.5.** Illustration of contact surface location for automatic Mortar contact, solids on top and shells below.



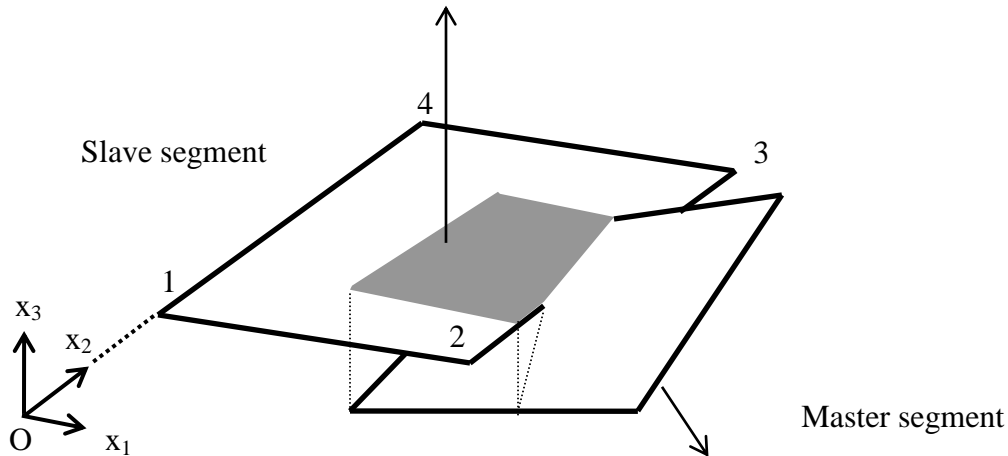


Figure 10.6. Illustration of Mortar segment to segment contact

INTERFACE TYPE ID	PENCHK	ELEMENT TYPE	FORMULA FOR RELEASE OF PENETRATING NODAL POINT
1, 2, 6, 7 3, 5, 8, 9, 10 (without thickness)	0	solid	$d = \text{PENMAX}$ if and only if $\text{PENMAX} > 0$ $d = 1.e+10$ if $\text{PENMAX} = 0$
		shell	$d = \text{PENMAX}$ if and only if $\text{PENMAX} > 0$ $d = 1.e+10$ if $\text{PENMAX} = 0$
	1	solid	$d = \text{XPENE} * \text{thickness of solid element}$
		shell	$d = \text{XPENE} * \text{thickness of shell element}$
	2	solid	$d = 0.05 * \text{minimum diagonal length}$
		shell	$d = 0.05 * \text{minimum diagonal length}$
3, 5, 10 (thickness) 17, and 18	—	solid	$d = \text{XPENE} * \text{thickness of solid element}$
		shell	$d = \text{XPENE} * \text{thickness of shell element}$
a3, a5, a10, 13, 15	—	solid	$d = \text{PENMAX} * \text{thickness of solid element}$ [default: $\text{PENMAX} = 0.5$ ]
		shell	$d = \text{PENMAX} * (\text{slave thickness} + \text{master thickness})$ [default: $\text{PENMAX} = 0.4$ ]
4	—	solid	$d = 0.5 * \text{thickness of solid element}$
		shell	$d = 0.4 * (\text{slave thickness} + \text{master thickness})$
26	—	solid	$d = \text{PENMAX} * \text{thickness of solid element}$ [default: $\text{PENMAX} = 200.0$ ]
		shell	$d = \text{PENMAX} * (\text{slave thickness} + \text{master thickness})$ [default: $\text{PENMAX} = 200.$ ]

Table 10.1. Criterion for node release for nodal points which have penetrated too far. Larger penalty stiffnesses are recommended for the contact interface which allows nodes to be released. For node-to-surface type contacts (5, 5a) the element thicknesses which contain the node determines the nodal

thickness. The parameter is defined on the \*CONTROL\_CONTACT input.

**The keyword options for the contact type and the corresponding Version 92X, 93X, 94X, 95X type numbers are:**

STRUCTURED INPUT TYPE ID	KEYWORD NAME
a13	AIRBAG_SINGLE_SURFACE
26	AUTOMATIC_GENERAL
i26	AUTOMATIC_GENERAL_INTERIOR
a 5	AUTOMATIC_NODES_TO_SURFACE
a 5	AUTOMATIC_NODES_TO_SURFACE_TIEBREAK
a10	AUTOMATIC_ONE_WAY_SURFACE_TO_SURFACE
13	AUTOMATIC_SINGLE_SURFACE
a 3	AUTOMATIC_SURFACE_TO_SURFACE
a 3	AUTOMATIC_SURFACE_TO_SURFACE_TIEBREAK
18	CONSTRAINT_NODES_TO_SURFACE
17	CONSTRAINT_SURFACE_TO_SURFACE
23	DRAWBEAD
16	ERODING_NODES_TO_SURFACE
14	ERODING_SURFACE_TO_SURFACE
15	ERODING_SINGLE_SURFACE
27	FORCE_TRANSDUCER_CONSTRAINT
25	FORCE_TRANSDUCER_PENALTY
m 5	FORMING_NODES_TO_SURFACE
m10	FORMING_ONE_WAY_SURFACE_TO_SURFACE
m 3	FORMING_SURFACE_TO_SURFACE
5	NODES_TO_SURFACE
5	NODES_TO_SURFACE_INTERFERENCE
10	ONE_WAY_SURFACE_TO_SURFACE
20	RIGID_NODES_TO_RIGID_BODY
21	RIGID_BODY_ONE_WAY_TO_RIGID_BODY
19	RIGID_BODY_TWO_WAY_TO_RIGID_BODY
22	SINGLE_EDGE
4	SINGLE_SURFACE
1	SLIDING_ONLY
p 1	SLIDING_ONLY_PENALTY
3	SURFACE_TO_SURFACE
3	SURFACE_TO_SURFACE_INTERFERENCE
8	TIEBREAK_NODES_TO_SURFACE
9	TIEBREAK_SURFACE_TO_SURFACE
6	TIED_NODES_TO_SURFACE
o 6	TIED_NODES_TO_SURFACE_OFFSET
7	TIED_SHELL_EDGE_TO_SURFACE
7	SPOTWELD
s 7	SPOTWELD_WITH_TORSION
2	TIED_SURFACE_TO_SURFACE
o 2	TIED_SURFACE_TO_SURFACE_OFFSET

**CONTACT EXAMPLES**

```

$
$$$$$$$$$$$$$$$$$$$$$$$$$$$$$$$$$$$$$$$$$$$$$$$$$$$$$$$$$$$$$$$$$$$$$$$$$$$$$$$$$$$$
$
$$$$ *CONTACT_NODES_TO_SURFACE
$
$$$$$$$$$$$$$$$$$$$$$$$$$$$$$$$$$$$$$$$$$$$$$$$$$$$$$$$$$$$$$$$$$$$$$$$$$$$$$$$$$$$$
$
$ Make a simple contact that prevents the nodes in part 2 from
$ penetrating the segments in part 3.
$
*CONTACT_NODES_TO_SURFACE
$
$.>...1.>...2.>...3.>...4.>...5.>...6.>...7.>...8
$   ssid      msid      sstyp   mstyp   sboxid   mboxid   spr      mpr
$         2         3         3         3
$
$   fs         fd         dc         vc         vdc      penchk   bt       dt
$
$   sfs        sfm        sst        mst        sfst     sfmt     fsf      vsf
$
$   sstype, mstype = 3 id's specified in ssid and msid are parts
$   ssid = 2 use slave nodes in part 2
$   msid = 3 use master segments in part 3
$
$ Use defaults for all parameters.
$
$$$$ Optional Cards A and B not specified (default values will be used).
$
$
$
$$$$$$$$$$$$$$$$$$$$$$$$$$$$$$$$$$$$$$$$$$$$$$$$$$$$$$$$$$$$$$$$$$$$$$$$$$$$$$$$$$$$
$

```



```

$$$$$$$$$$$$$$$$$$$$$$$$$$$$$$$$$$$$$$$$$$$$$$$$$$$$$$$$$$$$$$$$$$$$$$$$$$$$$$$$$$$$$$$$$$$$
$
$$$$ *CONTACT_DRAWBEAD
$
$$$$$$$$$$$$$$$$$$$$$$$$$$$$$$$$$$$$$$$$$$$$$$$$$$$$$$$$$$$$$$$$$$$$$$$$$$$$$$$$$$$$$$$$$$$$
$
$ Define a draw bead contact:
$ - the draw bead is to be made from the nodes specified in node set 2
$ - the master segments are to be those found in the box defined by box 2
$ that are in part 18
$ - include slave and master forces in interface file (spr, mpr = 1)
$
*CONTACT_DRAWBEAD
$
$.>....1.>....2.>....3.>....4.>....5.>....6.>....7.>....8
$ ssid msid sstyp mstyp sboxid mboxid spr mpr
$ 2 18 4 3 2 1 1
$
$ fs fd dc vc vdc penchk bt dt
$ 0.10
$
$ sfs sfm sst mst sfst sfmt fsf vsf
$
$$$$ Card 4 required because it's a drawbead contact
$
$ lcdidrf lcdnfn dbdth dfsc1 numint
$ 3 0.17436 2.0
$
$ lcdidrf = 3 load curve 3 specifies the bending component of the
$ restraining force per unit draw bead length
$ dbdth = 0.17436 draw bead depth
$ dfsc1 = 2.0 scale load curve 3 (lcdidrf) by 2
$
$$$$ Optional Cards A and B not specified (default values will be used).
$
*DEFINE_BOX
$ boxid xmm xmx ymn ymx zmn zmx
$ 2 0.000E+00 6.000E+00 6.000E+00 1.000E+02 -1.000E+03 1.000E+03
$
*SET_NODE_LIST
$ sid da1 da2 da3 da4
$ 2
$ nid1 nid2 nid3 nid4 nid5 nid6 nid7 nid8
$ 2580 2581 2582 2583 2584 2585 2586 2587
$ 2588 2589 2590
$
*DEFINE_CURVE
$ lcid sidr scla sclo offa offo
$ 3
$ a o
$ DEPTH FORC/LGTH
$ 0.000E+00 0.000E+00
$ 1.200E-01 1.300E+02
$ 1.500E-01 2.000E+02
$ 1.800E-01 5.000E+02

```

# \*CONTACT

## \*CONTACT\_AUTO\_MOVE

### \*CONTACT\_AUTO\_MOVE

Purpose: This feature allows for automatic move of a master surface in a contact definition to close an unspecified gap between a slave and the master surface. The gap may be caused as a result of an initial gravity loading on the slave part. The gap will be closed on a specified time to save CPU time. The master surface in metal forming application will typically be the upper cavity and the slave part will be the blank. This feature is applicable only in re-positioning of a tool in relationship to the blank after gravity loading in sheet metal forming application.

Cards 1            1            2            3            4            5            6            7            8

Variable	ID	CID	VID	LCID	ATIME			
Type	I	I	I	I	F			
Default	none	none	none	0	0.0			

#### VARIABLE

#### DESCRIPTION

ID	Move ID for this automatic move input. GT.0: velocity controlled tool kinematics (the variable VAD=0 in *BOUNDARY...) LT.0: displacement controlled tool kinematics (VAD=2)
CID	Contact ID
VID	Vector ID of a vector oriented in the direction of movement of the master surface, as in *DEFINE_VECTOR. The origin of the vector is unimportant since the direction cosines of the vector are computed and used.
LCID	Load curve defining tooling kinematics, either by velocity versus time or by displacement versus time. This load curve will be adjusted automatically during simulation to close the gap.
ATIME	Activation time defining the moment the master surface to be moved.

#### **Remarks:**

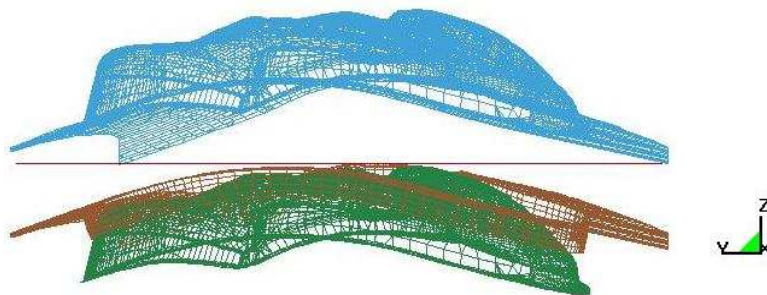
1. In an example shown below, referring to the partial input deck and figures attached, a combined simulation of gravity loading and binder closing of a fender outer is demonstrated. The geometry of the fender was taken from NUMISHEET 2002 benchmark. In this multi-

step implicit static set up, the blank is allowed 0.3 “time” unit to be loaded with gravity. At the end of gravity loading, a gap of 12mm was created between the upper die and the blank. The upper die is set to be moved at 0.3 time unit, closing the gap. It is noted that the upper die is controlled with displacement (VAD=2) of a triangular shape in the displacement versus “time” space as defined by load curve #201, and the ID in \*CONTACT\_AUTO\_MOVE is set to “-1”.

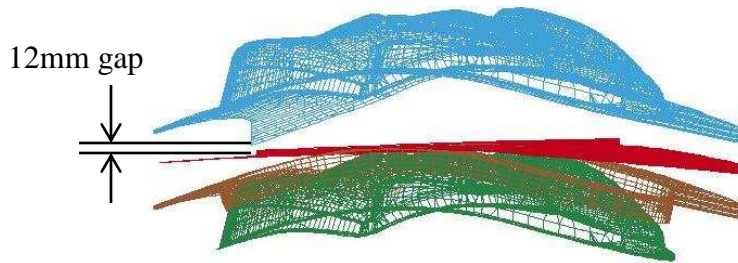
```

*PARAMETER
R grvtime      0.3
R endtime      1.0
R diemv        145.45
*CONTROL_TERMINATION
&endtime
*CONTROL_IMPLICIT_FORMING
2,2,100
*CONTROL_IMPLICIT_GENERAL
1,0.10
*CONTROL_ACCURACY
      1      2
*CONTACT_FORMING_ONE_WAY_SURFACE_TO_SURFACE_ID
11
.....
.....
.....
$---+---1---+---2---+---3---+---4---+---5---+---6---+---7---+---8
*BOUNDARY_PRESCRIBED_MOTION_RIGID
$#   pid   dof   vad   lcid   sf   vid   death   birth
      2     3     2    201 -1.000000   0     0.0     0.000
*CONTACT_AUTO_MOVE
$   ID   ContID   VID   LCID   ATIME
      -1     11     89    201   &grvtime
*DEFINE_VECTOR
89,0.0,0.0,0.0,0.0,0.0,-10.0
*DEFINE_CURVE
201
0.0,0.0
&grvtime,0.0
1.0,&diemv

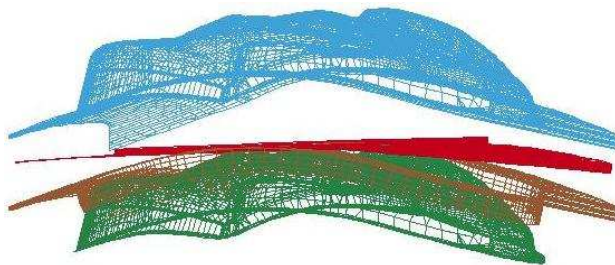
```



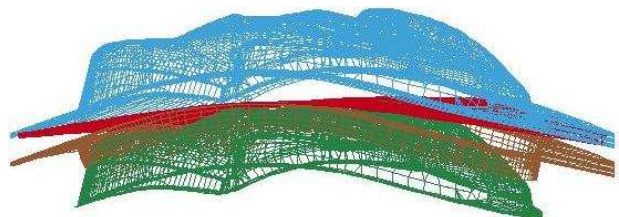
Initial position at t=0.0



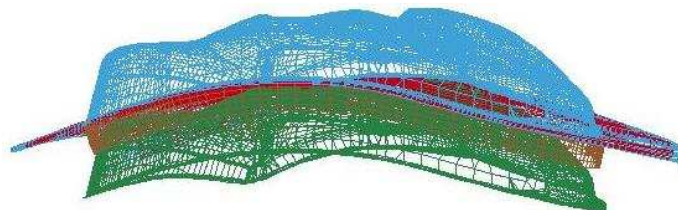
Gravity loaded shape at t=0.2



Upper die cavity moved at t=0.36  
closing the gap



Continue closing at t=0.743



Final closing at t=1.0

2. Similarly, for “velocity” controlled tool kinematics, an example is attached below. In this example, the “velocity” profile is ramped up initially and then kept constant. It is noted that the variable VAD in \*BOUNDARY is “0”, and ID in \*CONTACT\_AUTO\_MOVE is set to positive “1” indicating it is a velocity boundary condition.

```
*PARAMETER
R grvtime      0.3
R tramp        0.001
R diemv        145.45
R clsv         1000.0
*PARAMETER_EXPRESSION
R tramp1 tramp+gravtime
R endtime tramp1+(abs(diemv)-0.5*clsv*tramp)/clsv
```



```
*CONTACT_FORMING_ONE_WAY_SURFACE_TO_SURFACE_ID
11
....
....
$---+---1---+---2---+---3---+---4---+---5---+---6---+---7---+---8
*BOUNDARY_PRESCRIBED_MOTION_RIGID
$#      pid      dof      vad      lcid      sf      vid      death      birth
      2          3          0      201 -1.000000      0      0.0      0.000
*CONTACT_AUTO_MOVE
$      ID      ContID      VID      LCID      ATIME
      1          11          89      201 &grvtime
*DEFINE_VECTOR
89,0.0,0.0,0.0,0.0,0.0,-10.0
*DEFINE_CURVE
201
0.0,0.0
0.2,0.0
&tramp1,&clsv
&endtime,&clsv
```

3. For faster CPU time, it is recommended to set the variable SLSFAC in \*CONTROL\_CONTACT to a smaller number in implicit calculation.
4. Currently this feature is available for Implicit Static calculation only. It is implemented in LS-DYNA R5 Revision 64066 and later releases.

# \*CONTACT

# \*CONTACT\_COUPLING

## \*CONTACT\_COUPLING

Purpose: Define a coupling surface for MADYMO to couple LS-DYNA with deformable and rigid parts within MADYMO. In this interface, MADYMO computes the contact forces acting on the coupling surface, and LS-DYNA uses these forces in the update of the motion of the coupling surface for the next time step. Contact coupling can be used with other coupling options in LS-DYNA.

Card 1            1            2            3            4            5            6            7            8

Variable	ID							
Type	I							
Default	required							

**Cards 2, 3, 4, ... Define as cards as necessary. The next "\*" card terminates this input.**

Cards 2,3,..    1            2            3            4            5            6            7            8

Variable	SID	STYPE						
Type	I	I						
Default	required	0						

### VARIABLE

### DESCRIPTION

SID                      Set ID for coupling. See Remark 1 below.

STYPE                  Set type:  
EQ.0: part set  
EQ.1: shell element set  
EQ.2: solid element set  
EQ.3: thick shell element set

**Remarks:**

1. Only one coupling surface can be defined. If additional surfaces are defined, the coupling information will be added to the first definition.
2. The units and orientation can be converted by using the CONTROL\_COUPLING keyword. It is not necessary to use the same system of units in MADYMO and in LS-DYNA if unit conversion factors are defined.

**\*CONTACT\_ENTITY**

Purpose: Define a contact entity. Geometric contact entities treat the impact between a deformable body defined as a set of slave nodes or nodes in a shell part set and a rigid body. The shape of the rigid body is determined by attaching geometric entities. Contact is treated between these geometric entities and the slave nodes using a penalty formulation. The penalty stiffness is optionally maximized within the constraint of the Courant criterion. As an alternative, a finite element mesh made with shells can be used as geometric entity. Also, axisymmetric entities with arbitrary shape made with multi-linear polygons are possible. The latter is particularly useful for metalforming simulations.

WARNING: If the problem being simulated involves dynamic motion of the entity, care should be taken to insure that the inertial properties of the entity are correct. It may be necessary to use the \*PART\_INERTIA option to specify these properties.

**Define 5 cards for the contact entity definition below.**

Card 1                    1                    2                    3                    4                    5                    6                    7                    8

Variable	PID	GEOTYP	SSID	SSTYP	SF	DF	CF	INTORD
Type	I	I	I	I	F	F	F	I
Default	required	required	required	0	1.	0.	0.	0

**VARIABLE****DESCRIPTION**

PID

Part ID of the rigid body to which the geometric entity is attached, see \*PART.

GEOTYP

Type of geometric entity:

EQ.1: plane,

EQ.2: sphere,

EQ.3: cylinder,

EQ.4: ellipsoid,

EQ.5: torus,

EQ.6: CAL3D/MADYMO Plane, see Appendix I,

EQ.7: CAL3D/MADYMO Ellipsoid, see Appendix I,

EQ.8: VDA surface, see Appendix L,

EQ.9: rigid body finite element mesh (shells only),

EQ.10: finite plane,

EQ.11: load curve defining line as surface profile of axisymmetric rigid bodies.

<b>VARIABLE</b>	<b>DESCRIPTION</b>
SSID	Slave set ID, see *SET_NODE_OPTION, *PART, or *SET_PART.
SSTYP	Slave set type: EQ.0: node set, EQ.1: part ID, EQ.2: part set ID.
SF	Penalty scale factor. Useful to scale maximized penalty.
DF	Damping option, see description for *CONTACT_OPTION: EQ.0: no damping, GT.0: viscous damping in percent of critical, e.g., 20 for 20% damping, EQ.-n:  n  is the load curve ID giving the damping force versus relative normal velocity (see remark 1 below).
CF	Coulomb friction coefficient. Assumed to be constant.
INTORD	Integration order (slaved materials only). This option is not available with entity types 8 and 9 where only nodes are checked: EQ.0: check nodes only, EQ.1: 1 point integration over segments, EQ.2: 2×2 integration, EQ.3: 3×3 integration, EQ.4: 4×4 integration, EQ.5: 5×5 integration. This option allows a check of the penetration of the rigid body into the deformable (slaved) material. Then virtual nodes at the location of the integration points are checked.

**Remarks:**

1. The optional load curves that are defined for damping versus relative normal velocity and for force versus normal penetration should be defined in the positive quadrant. The sign for the damping force depends on the direction of the relative velocity and the treatment is symmetric if the damping curve is in the positive quadrant. If the damping force is defined in the negative and positive quadrants, the sign of the relative velocity is used in the table look-up.

# \*CONTACT

# \*CONTACT\_ENTITY

Card 2            1            2            3            4            5            6            7            8

Variable	BT	DT	SO	GO	ITHK			
Type	F	F	I	I	I			
Default	0.	1.E+20	0	0	0			

## VARIABLE

## DESCRIPTION

BT	Birth time
DT	Death time
SO	Flag to use penalty stiffness as in surface-to-surface contact: EQ.0: contact entity stiffness formulation, EQ.1: surface to surface contact method, EQ.-n:  n  is the load curve ID giving the force versus the normal penetration.
GO	Flag for mesh generation of the contact entity for entity types 1-5 and 10-11. This is used for visualization in post-processing only. EQ.0: mesh is not generated, EQ.1: mesh is generated.
ITHK	Flag for considering thickness for shell slave nodes (applies only to entity types 1, 2, 3; SSTYP must be set to zero). EQ.0: shell thickness is not considered, EQ.1: shell thickness is considered,

Card 3            1            2            3            4            5            6            7            8

Variable	XC	YC	ZC	AX	AY	AZ		
Type	F	F	F	F	F	F		
Default	0.	0.	0.	0.	0.	0		

Card 4            1            2            3            4            5            6            7            8

Variable	BX	BY	BZ					
Type	F	F	F					
Default	0.	0.	0.					

<u>VARIABLE</u>	<u>DESCRIPTION</u>
XC	x-center, $x_c$ , see remarks below.
YC	y-center, $y_c$ , see remarks below.
ZC	z-center, $z_c$ . See remarks below.
AX	x-direction for local axis A, $A_x$ , see remarks below.
AY	y-direction for local axis A, $A_y$ , see remarks below.
AZ	z-direction for local axis A, $A_z$ , see remarks below.
BX	x-direction for local axis B, $B_x$ , see remarks below.
BY	y-direction for local axis B, $B_y$ , see remarks below.
BZ	z-direction for local axis B, $B_z$ , see remarks below.

**Remarks:**

1. The coordinates,  $(x_c, y_c, z_c)$ , are the positions of the local origin of the geometric entity in global coordinates. The entity's local A-axis is determined by the vector  $(A_x, A_y, A_z)$  and the local B-axis by the vector  $(B_x, B_y, B_z)$ .
2. Cards 3 and 4 define a local to global transformation. The geometric contact entities are defined in a local system and transformed into the global system. For the ellipsoid, this is necessary because it has a restricted definition for the local position. For the plane, sphere, and cylinder, the entities can be defined in the global system and the transformation becomes  $(x_c, y_c, z_c)=(0,0,0)$ ,  $(A_x, A_y, A_z)=(1,0,0)$ , and  $(B_x, B_y, B_z)=(0,1,0)$ .

Card 5            1            2            3            4            5            6            7            8

Variable	INOUT	G1	G2	G3	G4	G5	G6	G7
Type	I	F	F	F	F	F	F	F
Default	0	0.	0.	0.	0.	0.	0.	0.

**VARIABLE****DESCRIPTION**

INOUT	In-out flag. Allows contact from the inside or the outside (default) of the entity: EQ.0: slave nodes exist outside of the entity, EQ.1: slave nodes exist inside the entity.
G1	Entity coefficient $g_1$ (CAL3D/MADYMO plane or ellipse number) for coupled analysis (see Appendix I).
G2	Entity coefficient $g_2$ , see remarks below.
G3	Entity coefficient $g_3$ , see remarks below.
G4	Entity coefficient $g_4$ , see remarks below.
G5	Entity coefficient $g_5$ , see remarks below.
G6	Entity coefficient $g_6$ , see remarks below.
G7	Entity coefficient $g_7$ , see remarks below.

**Remarks:**

Figures 10.7a and 10.7b show the definitions of the geometric contact entities. The relationships between the entity coefficients and the Figure 10.7a and 10.7b variables are as follows (please note that  $(P_x, P_y, P_z)$  is a position vector and that  $(Q_x, Q_y, Q_z)$  is a direction vector):

$$\begin{array}{ll}
 \text{GEOTYP} = 1: & g_1 = P_x & g_4 = Q_x \\
 & g_2 = P_y & g_5 = Q_y \\
 & g_3 = P_z & g_6 = Q_z \\
 & & g_7 = L
 \end{array}$$



If automatic generation is used, a square plane of length L on each edge is generated which represents the infinite plane. If generation is inactive, then g7 may be ignored.

GEOTYP = 2: g1 = Px g4 = r  
g2 = Py  
g3 = Pz

GEOTYP = 3: g1 = Px g4 = Qx  
g2 = Py g5 = Qy  
g3 = Pz g6 = Qz  
g7 = r

If automatic generation is used, a cylinder of length  $\sqrt{Qx^2 + Qy^2 + Qz^2}$  and radius r is generated which represents the infinite cylinder.

GEOTYP = 4: g1 = Px g4 = a  
g2 = Py g5 = b  
g3 = Pz g6 = c  
g7 = n (order of the ellipsoid)

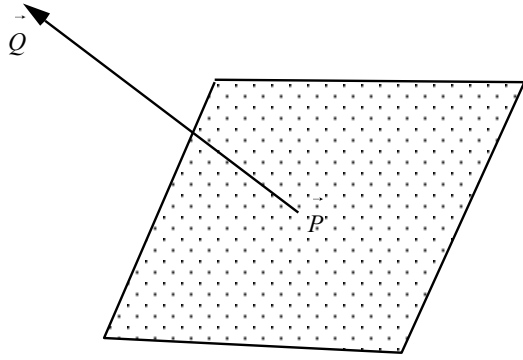
GEOTYP = 5: g1 = Radius of torus  
g2 = r  
g3 = number of elements along minor circumference  
g4 = number of elements along major circumference

GEOTYP = 8: g1 = Blank thickness (option to override true thickness)  
g2 = Scale factor for true thickness (optional)  
g3 = Load curve ID defining thickness versus time. (optional)

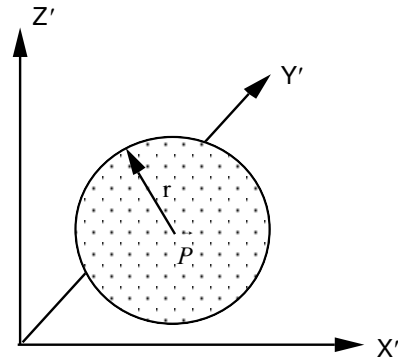
GEOTYP = 9: g1 = Shell thickness (option to override true thickness).  
**NOTE: The shell thickness specification is necessary if the slave surface is generated from solid elements.**  
g2 = Scale factor for true thickness (optional)  
g3 = Load curve ID defining thickness versus time. (optional)

GEOTYP =10: g1 = Length of edge along X' axis  
g2 = Length of edge along Y' axis

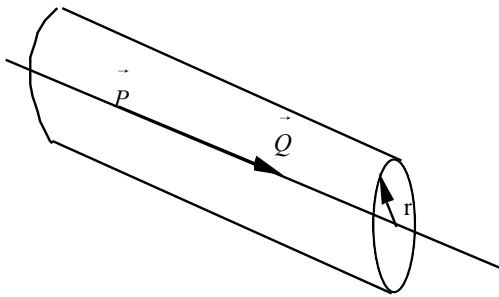
GEOTYP=11: g1 =Load curve ID defining axisymmetric surface profile about Z'-axis. Load curves defined by the keywords \*DEFINE\_CURVE or \*DEFINE\_CURVE\_ENTITY can be used.  
g2 = Number of elements along circumference  
EQ.0: default set to 10  
g3 = Number of elements along axis  
EQ.0: default set to 20  
EQ.-1: the elements are generated from the points on the load curve  
g4 = Number of sub divisions on load curve used to calculate contact  
EQ:0 default set to 1000



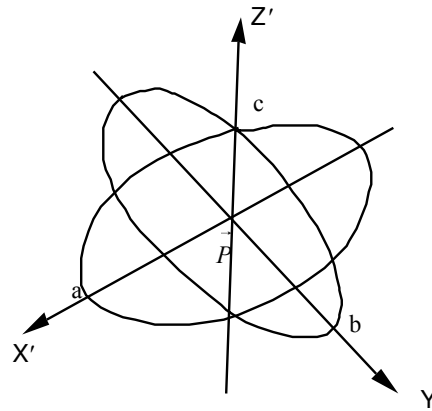
IGTYPE= 1: Infinite Plane



IGTYPE= 2: Sphere



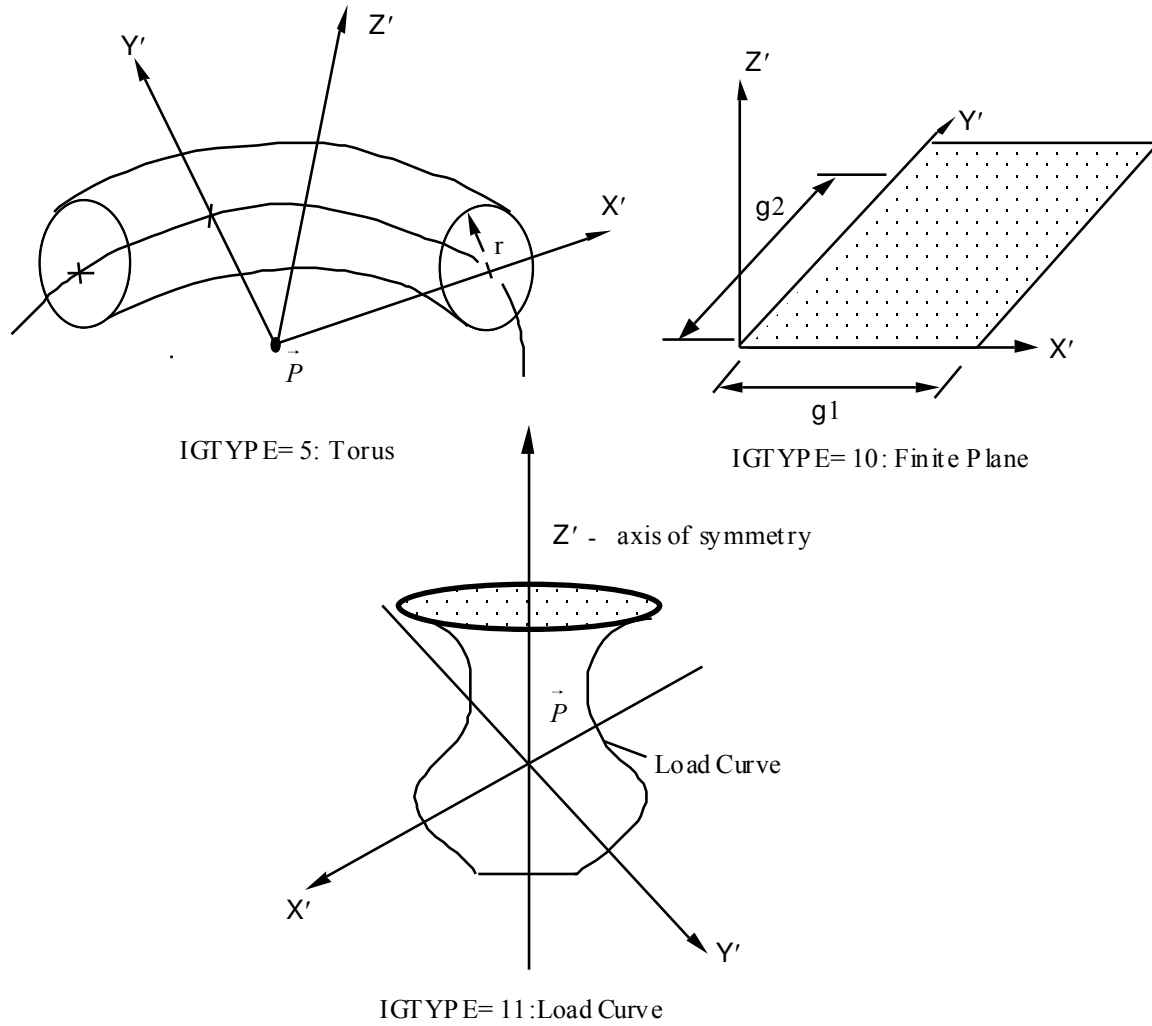
IGTYPE= 3: Infinite Cylinder



$$\left(\frac{X'}{a}\right)^n + \left(\frac{Y'}{b}\right)^n + \left(\frac{Z'}{c}\right)^n = 1$$

IGTYPE= 4: Hyperellipsoid

**Figure 10.7a.** Contact Entities.



**Figure 10.7b.** Contact Entities.

**\*CONTACT\_GEBOD\_OPTION**

Purpose: Define contact interaction between the segment of a GEBOD dummy and parts or nodes of the finite element model. This implementation follows that of the contact entity, however, it is specialized for the dummies. Forces may be output using the \*DATABASE\_GCEOUT command. See \*COMPONENT\_GEBOD and Appendix N for further details.

Conventional \*CONTACT\_OPTION treatment (surface-to-surface, nodes-to-surface, etc.) can also be applied to the segments of a dummy. To use this approach it is first necessary to determine part ID assignments by running the model through LS-DYNA's initialization phase.

The following options are available and refer to the ellipsoids which comprise the dummy. Options involving **HAND** are not applicable for the child dummy since its lower arm and hand share a common ellipsoid.

**LOWER\_TORSO**

**MIDDLE\_TORSO**

**UPPER\_TORSO**

**NECK**

**HEAD**

**LEFT\_SHOULDER**

**RIGHT\_SHOULDER**

**LEFT\_UPPER\_ARM**

**RIGHT\_UPPER\_ARM**

**LEFT\_LOWER\_ARM**

**RIGHT\_LOWER\_ARM**

**LEFT\_HAND**

**RIGHT\_HAND**

**LEFT\_UPPER\_LEG**

**RIGHT\_UPPER\_LEG**

**LEFT\_LOWER\_LEG**

**RIGHT\_LOWER\_LEG**

**LEFT\_FOOT**

**RIGHT\_FOOT**

Card 1            1            2            3            4            5            6            7            8

Variable	DID	SSID	SSTYP	SF	DF	CF	INTORD	
Type	I	I	I	F	F	F	I	
Default	required	required	required	1.	20.	0.5	0	

**VARIABLE**

**DESCRIPTION**

DID            Dummy ID, see \*COMPONENT\_GEBOD\_OPTION.

SSID            Slave set ID, see \*SET\_NODE\_OPTION, \*PART, or \*SET\_PART.

SSTYP            Slave set type:  
                   EQ.0: node set,  
                   EQ.1: part ID,  
                   EQ.2: part set ID.

SF              Penalty scale factor. Useful to scale maximized penalty.

DF              Damping option, see description for \*CONTACT\_OPTION:  
                   EQ.0: no damping,  
                   GT.0: viscous damping in percent of critical, e.g., 20 for 20%  
                   damping,  
                   EQ.-n: |n| is the load curve ID giving the damping force versus  
                   relative normal velocity (see Remark 1 below).

CF              Coulomb friction coefficient (see Remark 2 below). Assumed to be  
                   constant.

INTORD            Integration order (slaved materials only).  
                   EQ.0: check nodes only,  
                   EQ.1: 1 point integration over segments,  
                   EQ.2: 2×2 integration,  
                   EQ.3: 3×3 integration,  
                   EQ.4: 4×4 integration,  
                   EQ.5: 5×5 integration.  
                   This option allows a check of the penetration of the dummy segment  
                   into the deformable (slaved) material. Then virtual nodes at the location  
                   of the integration points are checked.

Card 2            1            2            3            4            5            6            7            8

Variable	BT	DT	SO					
Type	F	F	I					
Default	0.	1.E+20	0					

<u>VARIABLE</u>	<u>DESCRIPTION</u>
BT	Birth time
DT	Death time
SO	Flag to use penalty stiffness as in surface-to-surface contact: EQ.0: contact entity stiffness formulation, EQ.1: surface to surface contact method, EQ.-n:  n  is the load curve ID giving the force versus the normal penetration.

**Remarks:**

1. The optional load curves that are defined for damping versus relative normal velocity and for force versus normal penetration should be defined in the positive quadrant. The sign for the damping force depends on the direction of the relative velocity and the treatment is symmetric if the damping curve is in the positive quadrant. If the damping force is defined in the negative and positive quadrants, the sign of the relative velocity is used in the table look-up.
2. Insofar as these ellipsoidal contact surfaces are continuous and smooth it may be necessary to specify Coulomb friction values larger than those typically used with faceted contact surfaces.



# \*CONTACT

# \*CONTACT\_GUIDED\_CABLE

Card 1            1            2            3            4            5            6            7            8

Variable	NSID	PID/PSID	SOFT	SSFAC	FRIC			
Type	I	I	I	F	F			
Default	none	none	0	1.0	none			

## VARIABLE

## DESCRIPTION

NSID	Node set ID that guides the 1D elements.
PID/PSID	Part ID or part set ID if SET is included in the keyword line.
SOFT	Flag for soft constraint option. Set to 1 for soft constraint.
SSFAC	Stiffness scale factor for penalty stiffness value. The default value is unity. This applies to SOFT set to 0 and 1.
FRIC	Contact friction.



**\*CONTACT\_INTERIOR**

Purpose: Define interior contact for foam hexahedral and tetrahedral elements. Frequently, when foam materials are compressed under high pressure, the solid elements used to discretize these materials may invert leading to negative volumes and error terminations. In order to keep these elements from inverting, it is possible to consider interior contacts within the foam between layers of interior surfaces made up of the faces of the solid elements. Since these interior surfaces are generated automatically, the part (material) ID's for the materials of interest are defined here, prior to the interface definitions. **ONLY ONE PART SET ID CAN BE DEFINED.**

Card 1            1            2            3            4            5            6            7            8

Variable	PSID								
Type	I								
Default	none								

<u>VARIABLE</u>	<u>DESCRIPTION</u>
PSID	Part set ID including all parts for which interior contact is desired.

Four attributes should be defined for the part set:

- Attribute 1:        PSF, penalty scale factor (Default=1.00).
- Attribute 2:        Activation factor,  $F_a$  (Default=0.10). When the crushing of the element reaches  $F_a$  times the initial thickness the contact algorithm begins to act.
- Attribute 3:        ED, Optional modulus for interior contact stiffness.
- Attribute 4:        TYPE, Formulation for interior contact.  
                           EQ.1.0: Default, recommended for uniform compression  
                           EQ.2.0: Designed to control the combined modes of shear and compression. Works for type 1 brick formulation and type 10 tetrahedron formulation.

Define the part set with the \*SET\_PART\_COLUMN option to specify independent attribute values for each part in the part set,

**Remarks:**

The interior penalty is determined by the formula:

$$K = \frac{\text{SLSFAC} \cdot \text{PSF} \cdot \text{Volume}^{\frac{2}{3}} \cdot E}{\text{Min.Thickness}}$$

where SLSFAC is the value specified on the \*CONTROL\_CONTACT card , volume is the volume of the brick element, E is a constitutive modulus, and min. thickness is approximately the thickness of the solid element through its thinnest dimension. If ED, is defined above the interior penalty is then given instead by:

$$K = \frac{\text{Volume}^{\frac{2}{3}} \cdot ED}{\text{Min.Thickness}}$$

where the scaling factors are ignored. Generally, ED should be taken as the locking modulus specified for the foam constitutive model.

Caution should be observed when using this option since if the time step size is too large an instability may result. The time step size is not affected by the use of interior contact.

**\*CONTACT\_RIGID\_SURFACE**

Purpose: Define rigid surface contact. The purpose of rigid surface contact is to model large rigid surfaces, e.g., road surfaces, with nodal points and segments that require little storage and are written out at the beginning of the binary databases. The rigid surface motion, which can be optionally prescribed, is defined by a displacement vector which is written with each output state. The nodal points defining the rigid surface must be defined in the \*NODE\_RIGID\_SURFACE section of this manual. These rigid nodal points do not contribute degrees-of-freedom.

Card 1            1            2            3            4            5            6            7            8

Variable	CID	PSID	BOXID	SSID	FS	FD	DC	VC
Type	I	I	I	I	F	F	F	F
Default	none	none	0	none	0.	0.	0.	0.

Card 2            1            2            3            4            5            6            7            8

Variable	LCIDX	LCIDY	LCIDZ	FSLCID	FDLCID			
Type	I	I	I	I	I			
Default	0	0	0	0	0			

Card 3            1            2            3            4            5            6            7            8

Variable	SFS	STTHK	SFTHK	XPENE	BSORT	CTYPE		
Type	F	F	F	F	I	I		
Default	1.0	0.0	1.0	4.0	10	0		

<b>VARIABLE</b>	<b>DESCRIPTION</b>
CID	Contact interface ID. This must be a unique number.
PSID	Part set ID of all parts that may contact the rigid surface. See *SET_PART.
BOXID	Include only nodes of the part set that are within the specified box, see *DEFINE_BOX, in contact. If BOXID is zero, all nodes from the part set, PSID, will be included in the contact.
SSID	Segment set ID defining the rigid surface. See *SET_SEGMENT.
FS	Static coefficient of friction. The frictional coefficient is assumed to be dependent on the relative velocity $v_{rel}$ of the surfaces in contact $\mu_c = FD + (FS - FD)e^{-DC \cdot  v_{rel} }$ . If FSLCID is defined, see below, then FS is overwritten by the value from the load curve.
FD	Dynamic coefficient of friction. The frictional coefficient is assumed to be dependent on the relative velocity $v_{rel}$ of the surfaces in contact $\mu_c = FD + (FS - FD)e^{-DC \cdot  v_{rel} }$ . If FDLCID is defined, see below, then FD is overwritten by the value from the load curve.
DC	Exponential decay coefficient. The frictional coefficient is assumed to be dependent on the relative velocity $v_{rel}$ of the surfaces in contact $\mu_c = FD + (FS - FD)e^{-DC \cdot  v_{rel} }$ .
VC	Coefficient for viscous friction. This is necessary to limit the friction force to a maximum. A limiting force is computed $F_{lim} = VC \cdot A_{cont}$ . $A_{cont}$ being the area of the segment contacted by the node in contact. The suggested value for VC is to use the yield stress in shear $VC = \frac{\sigma_o}{\sqrt{3}}$ where $\sigma_o$ is the yield stress of the contacted material.
LCIDX	Load curve ID defining x-direction motion. If zero, there is no motion in the x-coordinate system.
LCIDY	Load curve ID defining y-direction motion. If zero, there is no motion in the y-coordinate system.
LCIDZ	Load curve ID defining z-direction motion. If zero, there is no motion in the z-coordinate system.
FSLCID	Load curve ID defining the static coefficient of friction as a function of

VARIABLE	DESCRIPTION
	interface pressure. This option applies to shell segments only.
FDLCID	Load curve ID defining the dynamic coefficient of friction as a function of interface pressure. This option applies to shell segments only.
SFS	Scale factor on default slave penalty stiffness, see also *CONTROL_CONTACT.
STTHK	Optional thickness for slave surface (overrides true thickness). This option applies to contact with shell, solid, and beam elements. True thickness is the element thickness of the shell elements. Thickness offsets are not used for solid element unless this option is specified.
SFTHK	Scale factor for slave surface thickness (scales true thickness). This option applies only to contact with shell elements. True thickness is the element thickness of the shell elements.
XPENE	Contact surface maximum penetration check multiplier. If the penetration of a node through the rigid surface exceeds the product of XPENE and the slave node thickness, the node is set free. EQ.0: default is set to 4.0.
BSORT	Number of cycles between bucket sorts. The default value is set to 10 but can be much larger, e.g., 50-100, for fully connected surfaces.
CTYPE	The contact formulation. The default, CTYPE=0, is equivalent to the ONE_WAY_SURFACE_TO_SURFACE formulation, and CTYPE=1 is a penalty formulation. If the slave surface belongs to a rigid body, CTYPE=1 must be used.

**Remarks:**

Thickness offsets do not apply to the rigid surface. There is no orientation requirement for the segments in the rigid surface, and the surface may be assembled from disjoint, but contiguous, arbitrarily oriented meshes. With disjoint meshes, the global searches must be done frequently, about every 10 cycles, to ensure a smooth movement of a slave node between mesh patches. For fully connected meshes this frequency interval can be safely set to 50-200 steps between searches.

The modified binary database (D3PLOT) contains the road surface information prior to the state data. This information contains:

NPDS = Total number of rigid surface points in problem.

NRSC	=	Total number of rigid surface contact segments summed over all definitions.
NSID	=	Number of rigid surface definitions.
NVELQ	=	Number of words at the end of each binary output state defining the rigid surface motion. This equals 6 x NSID if any rigid surface moves or zero if all rigid surfaces are stationary.
PIDS	=	An array equal in length to NPDS. This array defines the ID for each point in the road surface.
XC	=	An array equal in length to 3 x NPDS. This array defines the global x, y, and z coordinates of each point.

For each road surface define the following NSID sets of data.

ID	=	Rigid surface ID.
NS	=	Number of segments in rigid surface.
IXRS	=	An array equal in length to 4 x NS. This is the connectivity of the rigid surface in the internal numbering system.

At the end of each state, 6 x NVELQ words of information are written. For each road surface the x, y, and z displacements and velocities are written. If the road surface is fixed, a null vector should be output. Skip this section if NVELQ=0. LS-PREPOST currently displays rigid surfaces and animates their motion.

**\*CONTACT\_1D**

Purpose: Define one-dimensional slide lines for rebar in concrete.

Card 1            1            2            3            4            5            6            7            8

Variable	NSIDS	NSIDM	ERR	SIGC	GB	SMAX	EXP	
Type	I	I	F	F	F	F	F	
Default	none	none	0.	0.	0.	0.	0.	

<u>VARIABLE</u>	<u>DESCRIPTION</u>
NSIDS	Nodal set ID for the slave nodes, see *SET_NODE.
NSIDM	Nodal set ID for the master nodes, see *SET_NODE.
ERR	External radius of rebar
SIGC	Compressive strength of concrete
GB	Bond shear modulus
SMAX	Maximum shear strain
EXP	Exponent in damage curve

**Remarks:**

With this option the concrete is defined with solid elements and the rebar with truss elements, each with their own unique set of nodal points. A string of consecutive nodes, called slave nodes, related to the truss elements may slide along a string of consecutive nodes, called master nodes, related to the solid elements. The sliding commences after the rebar debonds.

The bond between the rebar and concrete is assumed to be elastic perfectly plastic. The maximum allowable slip strain is given as:

$$u_{max} = SMAX \cdot e^{-EXP \cdot D}$$

where D is the damage parameter  $D_{n+1} = D_n + \Delta u$ . The shear force, acting on area  $A_s$ , at time n+1 is given as:

$$f_{n+1} = \min ( f_n - GB \cdot A_s \cdot \Delta u, GB \cdot A_s \cdot u_{\max} )$$



**\*CONTACT\_2D\_OPTION1\_{OPTION2}\_{OPTION3}**

Purpose: Define a 2-dimensional contact or slide line. This option is to be used with 2D solid and shell elements using the `plane_stress`, `plane_strain` or axisymmetric formulations, see `*SECTION_SHELL`.

OPTION1 specifies the contact type. The following options should be used with deformable materials only (i.e., not rigid):

**SLIDING\_ONLY****TIED\_SLIDING****SLIDING\_VOIDS**

since these methods are based on the imposition of constraints. The constraint methods may be used with rigid bodies if the rigid body is the master surface and all rigid body motions are prescribed. The following options may be used with rigid materials as well:

**PENALTY\_FRICTION****PENALTY****AUTOMATIC\_SINGLE\_SURFACE****AUTOMATIC\_SURFACE\_TO\_SURFACE****AUTOMATIC\_NODE\_TO\_SURFACE****AUTOMATIC\_SURFACE\_IN\_CONTINUUM****AUTOMATIC\_TIED****AUTOMATIC\_TIED\_ONE\_WAY**

The following options should be used for SPH particles in contact with 2D solid elements (2D shell elements are not supported currently) using the `plane_stress`, `plane_strain` or axisymmetric formulation:

**NODE\_TO\_SOLID****NODE\_TO\_SOLID\_TIED**

OPTION2 specifies a thermal contact and takes the single option:

**THERMAL**

Only the AUTOMATIC types: `SINGLE_SURFACE`, `SURFACE_TO_SURFACE`, and `NODE_TO_SURFACE` may be used with this option.



For all options EXCEPT the AUTOMATIC and NODE\_TO\_SOLID options, define the following two cards.

Card 1            1            2            3            4            5            6            7            8

Variable	SSID	MSID	TBIRTH	TDEATH				
Type	I	I	F	F				
Default	none	none	0.	1.e20				

Card 2            1            2            3            4            5            6            7            8

Variable	EXT_PAS	THETA1	THETA2	TOL_IG	PEN	TOLOFF	FRCSCCL	ONEWAY
Type	I	F	F	F	F	F	F	F
Default	none	none	none	0.001	0.1	0.025	0.010	0.0

For the PENALTY\_FRICTION option define the following additional card

Card 3            1            2            3            4            5            6            7            8

Variable	FRIC	FRIC_L	FRIC_H	FRIC_S				
Type	F	F	F	F				

**VARIABLE****DESCRIPTION**

SSID	Nodal set ID for the slave nodes, see *SET_NODE. <b>The slave surface must be to the left of the master surface.</b>
MSID	Nodal set ID for the master nodes, see *SET_NODE.
TBIRTH	Birth time for contact.
TDEATH	Death time for contact.

---

<b>VARIABLE</b>	<b>DESCRIPTION</b>
EXT_PAS	Slideline extension bypass option. EQ.0: extensions are use EQ.1: extensions are not used
THETA1	Angle in degrees of slideline extension at first master node. EQ.0: extension remains tangent to first master segment.
THETA2	Angle in degrees of slideline extension at last master node. EQ.0: extension remains tangent to last master segment.
TOL_IG	Tolerance for determining initial gaps. EQ.0.0: default set to 0.001
PEN	Scale factor or penalty. EQ.0.0: default set to 0.10
TOLOFF	Tolerance for stiffness insertion for implicit solution only. The contact stiffness is inserted when a node approaches a segment a distance equal to the segment length multiplied by TOLOFF. The stiffness is increased as the node moves closer with the full stiffness being used when the nodal point finally makes contact. EQ.0.0: default set to 0.025.
FRCSCS	Scale factor for the interface friction. EQ.0.0: default set to 0.010
ONEWAY	Flag for one way treatment. If set to 1.0 the nodal points on the slave surface are constrained to the master surface. This option is generally recommended if the master surface is rigid. EQ.1.0: activate one way treatment.
FRIC	Coefficient of friction
FRIC_L	Coefficient of friction at low velocity.
FRIC_H	Coefficient of friction at high velocity.
FRIC_S	Friction factor for shear.

**\*CONTACT\_2D\_AUTOMATIC** Options:

**For the AUTOMATIC options define the following two cards:**

Card 1            1            2            3            4            5            6            7            8

Variable	SIDS	SIDM	SFACT	FREQ	FS	FD	DC	
Type	I	I	F	I	F	F	F	
Default	none	none	1.0	50	0.	0.	0.	
Remarks	1,2	1,2						

Card 2            1            2            3            4            5            6            7            8

Variable	TBIRTH	TDEATH	SOS	SOM	NDS	NDM	COF	INIT
Type	F	F	F	F	I	I	I	I
Default	0.	1.e20	1.0	1.0	0	0	0	0
Remarks			3	3	4	5		8

**This Card is mandatory for the THERMAL option, i.e.,:**

**\*CONTACT\_AUTOMATIC\_...\_THERMAL\_.....**

Optional        1            2            3            4            5            6            7            8

Variable	K	RAD	H	LMIN	LMAX	CHLM	BC_FLAG	
Type	F	F	F	F	F	F	I	
Default	none	none	none	none	none	1.0	0	

**Optional Card A**

Card A            1            2            3            4            5            6            7            8

Variable	VC	VDC	IPF	SLIDE	ISTIFF	TIEDGAP		
Type	F	F	I	I	I	R		
Default	0.	10.0	0	0	0			
Remarks				10	11	12		

**VARIABLE****DESCRIPTION**

SIDS	Set ID to define the slave surface. If SIDS>0, a part set is assumed, see *SET_PART. If SIDS<0, a node set with ID equal to the absolute value of SIDS is assumed, see *SET_NODE.
SIDM	Set ID to define the master surface. If SIDM>0, a part set is assumed, see *SET_PART. If SIDM<0, a node set with ID equal to the absolute value of SIDM is assumed, see *SET_NODE. Do not define for single surface contact.
SFACT	Scale factor for the penalty force stiffness.
FREQ	Search frequency. The number of timesteps between bucket sorts. For implicit contact this parameter is ignored and the search frequency is 1. EQ.0: default set to 50.
FS	Static coefficient of friction. The frictional coefficient is assumed to be dependent on the relative velocity $v_{rel}$ of the surfaces in contact according to the relationship given by: $\mu_c = FD + (FS - FD)e^{-DC \cdot  v_{rel} }$ .
FD	Dynamic coefficient of friction. The frictional coefficient is assumed to be dependent on the relative velocity $v_{rel}$ of the surfaces in contact $\mu_c = FD + (FS - FD)e^{-DC \cdot  v_{rel} }$ .
DC	Exponential decay coefficient. The frictional coefficient is assumed to be dependent on the relative velocity $v_{rel}$ of the surfaces in contact $\mu_c = FD + (FS - FD)e^{-DC \cdot  v_{rel} }$ .
TBIRTH	Birth time for contact.

VARIABLE	DESCRIPTION
TDEATH	Death time for contact.
SOS	Surface offset from midline for 2D shells of slave surface EQ.0.0: default to 1. GT.0.0: scale factor applied to actual thickness LT.0.0: absolute value is used as the offset
SOM	Surface offset from midline for 2D shells of master surface EQ.0: default to 1. GT.0: scale factor applied to actual thickness LT.0: absolute value is used as the offset
NDS	Normal direction flag for 2D shells of slave surface EQ.0: Normal direction is determined automatically EQ.1: Normal direction is in the positive direction EQ.-1: Normal direction is in the negative direction
NDM	Normal direction flag for 2D shells of master surface EQ.0: Normal direction is determined automatically EQ.1: Normal direction is in the positive direction EQ.-1: Normal direction is in the negative direction
COF	Closing/Opening flag for implicit contact EQ.0: Recommended for most problem where gaps are only closing. EQ.1: Recommended when gaps are opening to avoid sticking.
INIT	Special processing during initialization EQ.0: No special processing. EQ.1: Forming option.
K	Thermal conductivity (k) of fluid between the slide surfaces. If a gap with a thickness $l_{\text{gap}}$ exists between the slide surfaces, then the conductance due to thermal conductivity between the slide surfaces is $h_{\text{cond}} = \frac{k}{l_{\text{gap}}}$ Note that LS- DYNA calculates $l_{\text{gap}}$ based on deformation.
RAD	Radiation factor, f, between the slide surfaces. A radiant-heat-transfer coefficient ( $h_{\text{rad}}$ ) is calculated (see *BOUNDARY_RADIATION). If a gap exists between the slide surfaces, then the contact conductance is calculated by $h = h_{\text{cond}} + h_{\text{rad}}$

<b>VARIABLE</b>	<b>DESCRIPTION</b>
H	Heat transfer conductance ( $h_{\text{cont}}$ ) for closed gaps. Use this heat transfer conductance for gaps in the range $0 \leq l_{\text{gap}} \leq l_{\text{min}}$ where $l_{\text{min}}$ is GCRIT defined below.
LMIN	Critical gap ( $l_{\text{min}}$ ), use the heat transfer conductance defined (HTC) for gap thicknesses less than this value.
LMAX	No thermal contact if gap is greater than this value ( $l_{\text{max}}$ ).
CHLM	Is a multiplier used on the element characteristic distance for the search routine. The characteristic length is the largest interface surface element diagonal. EQ.0: Default set to 1.0
BC_FLAG	Thermal boundary condition flag EQ.0: thermal boundary conditions are <b>on</b> when parts are in contact EQ.1: thermal boundary conditions are <b>off</b> when parts are in contact
VC	Coefficient for viscous friction. This is used to limit the friction force to a maximum. A limiting force is computed $F_{\text{lim}} = VC \cdot A_{\text{cont}}$ . $A_{\text{cont}}$ being the area of contacted between segments. The suggested value for VC is to use the yield stress in shear: $VC = \frac{\sigma_o}{\sqrt{3}}$ where $\sigma_o$ is the yield stress of the contacted material.
VDC	Viscous damping coefficient in percent of critical for explicit contact.
IPF	Initial penetration flag for explicit contact. EQ.0: Allow initial penetrations to remain EQ.1: Push apart initially penetrated surfaces
SLIDE	Sliding option. EQ.0: Off EQ.1: On



---

<u>VARIABLE</u>	<u>DESCRIPTION</u>
ISTIFF	Stiffness scaling option. EQ.0: Use default option. EQ.1: Scale stiffness using segment masses and explicit time step (default for explicit contact) EQ.2: Scale stiffness using segment stiffness and dimensions (default for implicit contact)
TIEDGAP	Search gap for tied contacts. EQ.0: Default, use 1% of the master segment length GT.0: Use the input value LT.0: Use n% of the master segment length where n= TIEDGAP

# \*CONTACT\_2D

\*CONTACT\_2D\_OPTION1\_{OPTION2}\_{OPTION3}

\*CONTACT\_2D\_NODE\_TO\_SOLID Options:

For the NODE\_TO\_SOLID options define the following two cards:

Card 1            1            2            3            4            5            6            7            8

Variable	SSID	MSID	TBIRTH	TDEATH				
Type	I	I	F	F				
Default	none	none	0.	1.e20				

Card 2            1            2            3            4            5            6            7            8

Variable					PEN			
Type					F			
Default					1.0			

**VARIABLE**

**DESCRIPTION**

SSID	Nodal set ID or part set ID for the slave nodes, If SSID>0, a nodal set ID is assumed, If SSID<0 a part set ID is assumed.
MSID	Master part set ID. MSID<0 since only part set is allowed.
TBIRTH	Birth time for contact.
TDEATH	Death time for contact.
PEN	Scale factor for penalty. EQ.0.0: default set to 1.0

**Remarks:**

Remarks 1 through 12 pertain to 2D\_AUTOMATIC contact, Remarks 13 pertain to NODE\_TO\_SOLID contact.

1. For AUTOMATIC\_SURFACE\_TO\_SURFACE, AUTOMATIC\_SINGLE\_SURFACE contact and AUTOMATIC\_NODE\_TO\_SURFACE contact, penetration of 2D shell elements and external faces of 2D continuum elements is prevented by penalty forces. Parts in the slave part set are checked for contact with parts in the master part set. Self contact is checked for any part in both sets. If the slave part set is omitted, all parts are checked for contact. If the master part set is omitted, it is assumed to be identical to the slave part set.
2. For AUTOMATIC\_SURFACE\_IN\_CONTINUUM contact, penalty forces prevent the flow of slave element material (the continuum) through the master surfaces. Flow of the continuum tangent to the surface is permitted. Only 2D solid parts are permitted in the slave part set. Both 2D solid and 2D shell parts are permitted in the master part set. Neither the slave part set ID or the master part set ID may be omitted.
3. By default, the true thickness of 2D shell elements is taken into account for AUTOMATIC\_SURFACE\_TO\_SURFACE and AUTOMATIC\_NODE\_TO\_SURFACE contact. The user can override the true thickness by using SOS and SOM. If the surface offset is reduced to a small value, the automatic normal direction algorithm may fail, so it is best to specify the normal direction using NDS or NDM. Thickness of 2D shell elements is not considered for AUTOMATIC\_SURFACE\_IN\_CONTINUUM contact.
4. By default, the normal direction of 2D shell elements is evaluated automatically for AUTOMATIC\_SURFACE\_TO\_SURFACE and AUTOMATIC\_NODE\_TO\_SURFACE contact. The user can override the automatic algorithm using NDS or NDM and contact will occur with the positive or negative face of the element.
5. For SURFACE\_IN\_CONTINUUM contact, flow through 2D shell elements is prevented in both directions by default. If NDM is set to  $\pm 1$ , flow in the direction of the normal is permitted.
6. When using AUTOMATIC\_SURFACE\_IN\_CONTINUUM contact, there is no need to mesh the continuum around the structure because contact is not with continuum nodes but with material in the interior of the continuum elements. The algorithm works well for Eulerian or ALE elements since the structure does not interfere with remeshing. However, a structure will usually not penetrate the surface of an ALE continuum since the nodes are Lagrangian normal to the surface. Therefore, if using an ALE fluid, the structure should be initially immersed in the fluid and remain immersed throughout the calculation. Penetrating the surface of an Eulerian continuum is not a problem.
7. For all types of 2D\_AUTOMATIC contact, eroding materials are treated by default. At present, subcycling is not possible.

8. Currently only one special initialization option is available. The forming option is intended for implicit solutions of thin solid parts when back side segments may interfere with the solution. It automatically removes back side segments during initialization. If slave or master surfaces are defined by node sets, the forming option should be turned off.
9. For the thermal option:  
$$h = h_{\text{cont}}, \text{ if the gap thickness is } 0 \leq l_{\text{gap}} \leq l_{\text{min}}$$
$$h = h_{\text{cond}} + h_{\text{rad}}, \text{ if the gap thickness is } l_{\text{min}} \leq l_{\text{gap}} \leq l_{\text{max}}$$
$$h = 0, \text{ if the gap thickness is } l_{\text{gap}} > l_{\text{max}}$$
10. When turned on, the sliding option activates additional logic intended to improve sliding when surfaces in contact have kinks or corners. This option is off by default.
11. The ISTIFF option allows control of the equation used in calculating the penalty stiffness. For backward compatibility, the default values are different for implicit and explicit solutions. When ISTIFF=1 is used, the explicit time step appears in the stiffness equation regardless if the calculation is implicit or explicit.
12. AUTOMATIC\_TIED\_ONE\_WAY contact creates two degree of freedom translational kinematic constraints to nodes on the slave surface which are initially located on or near master segments. AUTOMATIC\_TIED contact creates kinematic constraints between slave nodes and master segments, and also creates penalty constraints between master nodes and slave segments. With either contact option, a kinematic constraint may be switched to penalty if there is a conflict with another constraint. The TIEDGAP parameter determines the maximum normal distance from a segment to a node for a constraint to be formed. Nodes will not be moved to eliminate an initial gap, and the initial gap will be maintained throughout the calculation.
13. NODE\_TO\_SOLID contact is a penalty based contact type used particularly for SPH particles with solid elements using the plane\_stress, plane\_strain or axisymmetric formulation. NODE\_TO\_SOLID\_TIED contact is used for SPH particles tied with solid elements, an offset of distance h (smooth length) is adopted for each SPH particle.

The remaining discussion applies to the SLIDING\_ONLY, TIED\_SLIDING, SLIDING\_VOIDS, PENALTY\_FRICTION, and PENALTY options. These options were adopted from LS-DYNA2D and originated in the public domain version of DYNA2D from the Lawrence Livermore National Laboratory. The AUTOMATIC contact options are generally recommended excepted for the TIED option.

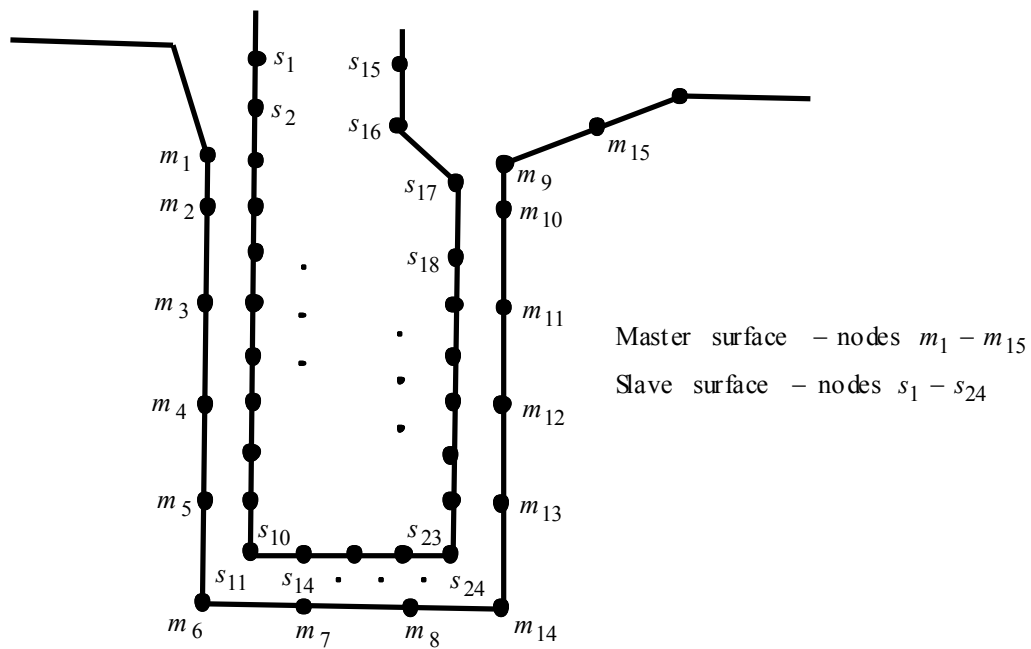
Consider two slideline surfaces in contact. It is necessary to designate one as a slave surface and the other as a master surface. Nodal points defining the slave surface are called slave nodes, and similarly, nodes defining the master surface are called master nodes. Each slave-master surface combination is referred to as a slideline.

Many potential problems with the algorithm can be avoided by observing the following precautions:

- Metallic materials should contain the master surface along high explosive-metal interfaces.
- Sliding only type slidelines are appropriate along high explosive-metal interfaces. The penalty formulation is not recommended along such interfaces.
- If one surface is more finely zoned, it should be used as the slave surface. If penalty slidelines are used, PENALTY and PENALTY\_FRICTION, the slave-master distinction is irrelevant.
- A slave node may have more than one master segment, and may be included as a member of a master segment if a slideline intersection is defined.
- Angles in the master side of a slideline that approach 90° must be avoided.

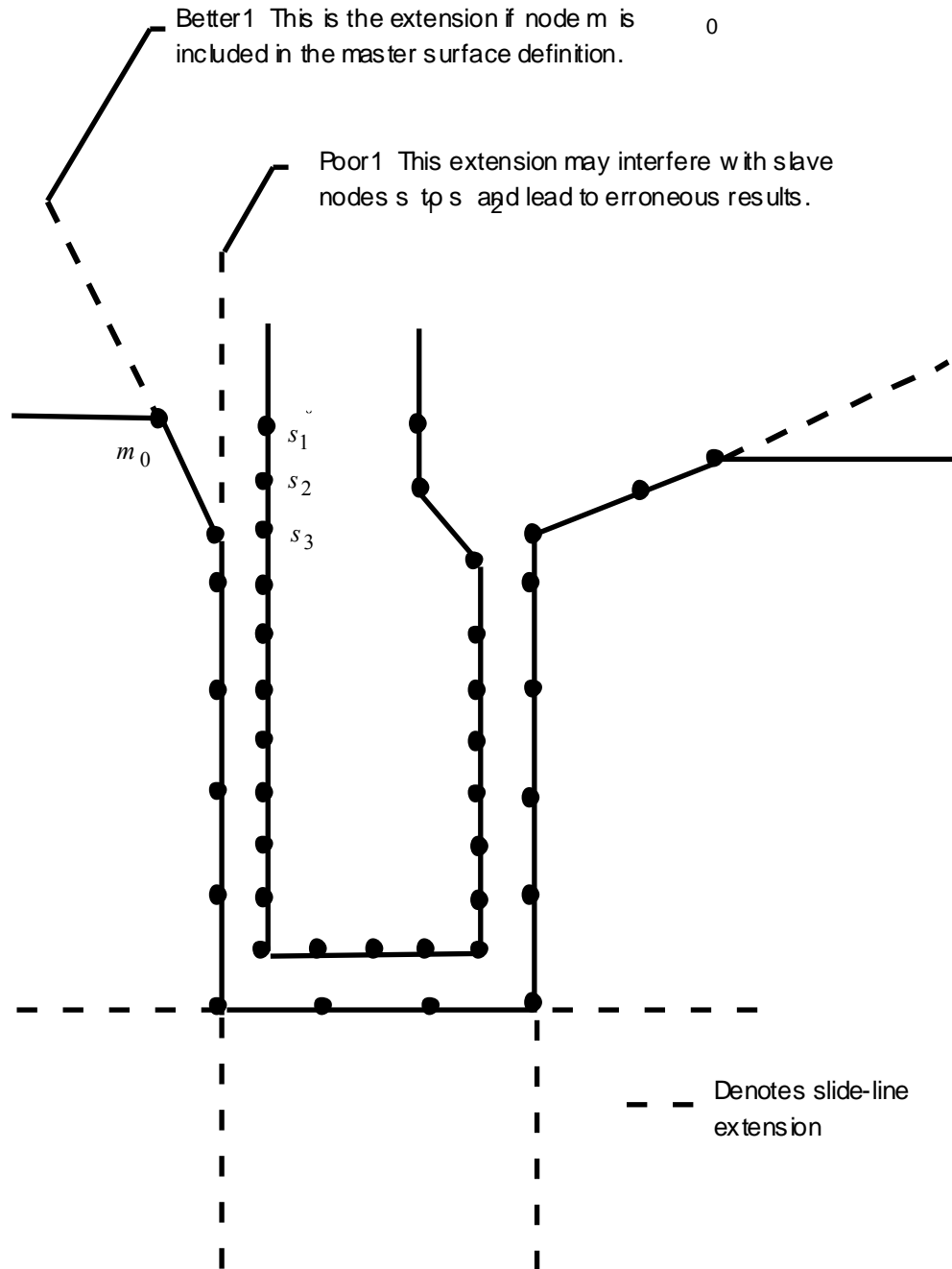
Whenever such angles exist in a master surface, two or more slidelines should be defined. This procedure is illustrated in Figure 10.8. An exception for the foregoing rule arises if the surfaces are tied. In this case, only one slideline is needed.

- Whenever two surfaces are in contact, the smaller of the two surfaces should be used as the slave surface. For example, in modeling a missile impacting a wall, the contact surface on the missile should be used as the slave surface.
- Care should be used when defining a master surface to prevent the extension from interfering with the solution. In Figures 10.9 and 10.10, slideline extensions are shown.

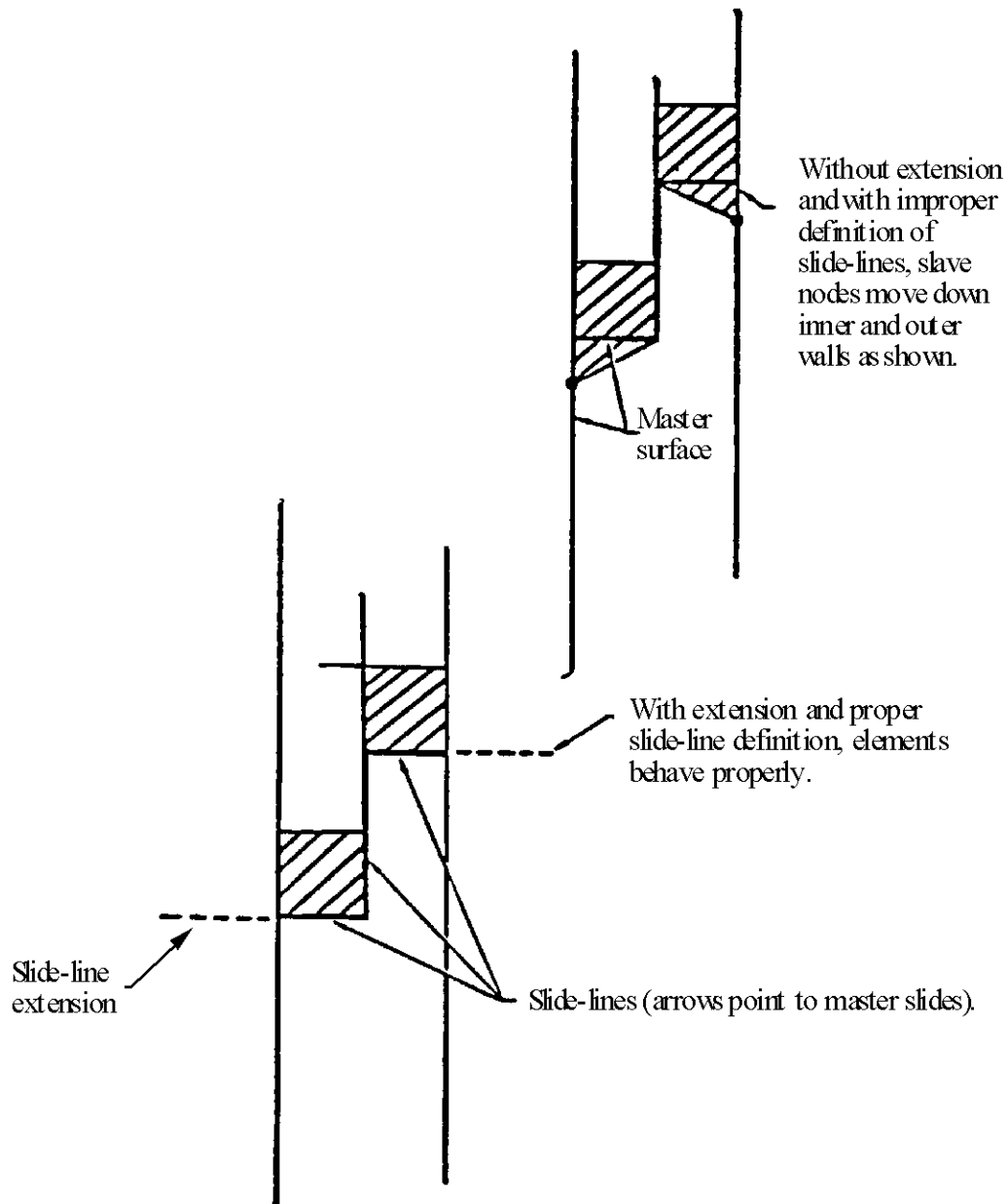


1		2		3	
<u>Slaves</u>	<u>Masters</u>	<u>Slaves</u>	<u>Masters</u>	<u>Slaves</u>	<u>Masters</u>
s1	m1	s11	m6	s24	m14
s2	m2	s12	m7	s23	m13
.	.	.	m8	.	.
.	.	.	m14	.	.
.	.	.	.	.	.
		s14			m9
s11	m6	s24		s15	m15

**Figure 10.8.** Proper definition of illustrated slave-master surface requires three slidelines (note that slave surface is to the left of the master surface as one moves along master nodes in order of definition).



**Figure 10.9.** Master surface extensions defined automatically by DYNA (extensions are updated every time step to remain tangent to ends of master sides of slidelines unless angle of extension is defined in input).



**Figure 10.10.** Example of slideline extensions helping to provide realistic response.



# \*CONTROL

The keyword control cards are optional and can be used to change defaults, activate solution options such as mass scaling, adaptive remeshing, and an implicit solution; however, it is advisable to define the \*CONTROL\_TERMINATION card. **The ordering of the control cards in the input file is arbitrary. To avoid ambiguities, define no more than one control card of each type.** The following control cards are organized in alphabetical order:

- \*CONTROL\_ACCURACY
- \*CONTROL\_ADAPSTEP
- \*CONTROL\_ADAPTIVE
- \*CONTROL\_ALE
- \*CONTROL\_BULK\_VISCOSITY
- \*CONTROL\_CHECK\_{OPTION}
- \*CONTROL\_COARSEN
- \*CONTROL\_CONTACT
- \*CONTROL\_COUPLING
- \*CONTROL\_CPU
- \*CONTROL\_DYNAMIC\_RELAXATION
- \*CONTROL\_EFG
- \*CONTROL\_ENERGY
- \*CONTROL\_EXPLOSIVE\_SHADOW
- \*CONTROL\_FORMING\_POSITION
- \*CONTROL\_FORMING\_TEMPLATE
- \*CONTROL\_FORMING\_TRAVEL
- \*CONTROL\_FORMING\_USER
- \*CONTROL\_HOURLASS\_{OPTION}
- \*CONTROL\_IMPLICIT\_AUTO
- \*CONTROL\_IMPLICIT\_BUCKLE
- \*CONTROL\_IMPLICIT\_CONSISTENT\_MASS
- \*CONTROL\_IMPLICIT\_DYNAMICS
- \*CONTROL\_IMPLICIT\_EIGENVALUE
- \*CONTROL\_IMPLICIT\_GENERAL
- \*CONTROL\_IMPLICIT\_INERTIA\_RELIEF
- \*CONTROL\_IMPLICIT\_JOINTS
- \*CONTROL\_IMPLICIT\_MODES
- \*CONTROL\_IMPLICIT\_SOLUTION
- \*CONTROL\_IMPLICIT\_SOLVER
- \*CONTROL\_IMPLICIT\_STABILIZATION
- \*CONTROL\_IMPLICIT\_TERMINATION
- \*CONTROL\_MPP\_DECOMPOSITION\_AUTOMATIC
- \*CONTROL\_MPP\_DECOMPOSITION\_DISTRIBUTE\_BAGREF
- \*CONTROL\_MPP\_DECOMPOSITION\_CHECK\_SPEED
- \*CONTROL\_MPP\_DECOMPOSITION\_CONTACT\_DISTRIBUTE

# **\*CONTROL**

---

**\*CONTROL\_MPP\_DECOMPOSITION\_CONTACT\_ISOLATE**  
**\*CONTROL\_MPP\_DECOMPOSITION\_DISTRIBUTE\_ALE\_ELEMENTS**  
**\*CONTROL\_MPP\_DECOMPOSITION\_DISTRIBUTE\_SPH\_ELEMENTS**  
**\*CONTROL\_MPP\_DECOMPOSITION\_ELCOST**  
**\*CONTROL\_MPP\_DECOMPOSITION\_FILE**  
**\*CONTROL\_MPP\_DECOMPOSITION\_METHOD**  
**\*CONTROL\_MPP\_DECOMPOSITION\_NUMPROC**  
**\*CONTROL\_MPP\_DECOMPOSITION\_OUTDECOMP**  
**\*CONTROL\_MPP\_DECOMPOSITION\_PARTS\_DISTRIBUTE**  
**\*CONTROL\_MPP\_DECOMPOSITION\_SCALE\_CONTACT\_COST**  
**\*CONTROL\_MPP\_DECOMPOSITION\_SCALE\_FACTOR\_SPH**  
**\*CONTROL\_MPP\_DECOMPOSITION\_SHOW**  
**\*CONTROL\_MPP\_DECOMPOSITION\_TRANSFORMATION**  
**\*CONTROL\_MPP\_IO\_BINOUTONLY**  
**\*CONTROL\_MPP\_IO\_LSTC\_REDUCE**  
**\*CONTROL\_MPP\_IO\_NOD3DUMP**  
**\*CONTROL\_MPP\_IO\_NODUMP**  
**\*CONTROL\_MPP\_IO\_NOFULL**  
**\*CONTROL\_MPP\_IO\_SWAPBYTES**  
**\*CONTROL\_NONLOCAL**  
**\*CONTROL\_OUTPUT**  
**\*CONTROL\_PARALLEL**  
**\*CONTROL\_PORE\_FLUID**  
**\*CONTROL\_REMESHING**  
**\*CONTROL\_RIGID**  
**\*CONTROL\_SHELL**  
**\*CONTROL\_SOLID**  
**\*CONTROL\_SOLUTION**  
**\*CONTROL\_SPH**  
**\*CONTROL\_SPOTWELD\_BEAM**  
**\*CONTROL\_STAGED\_CONSTRUCTION**  
**\*CONTROL\_STRUCTURED\_{OPTION}**  
**\*CONTROL\_SUBCYCLE**  
**\*CONTROL\_TERMINATION**  
**\*CONTROL\_THERMAL\_NONLINEAR**  
**\*CONTROL\_THERMAL\_SOLVER**  
**\*CONTROL\_THERMAL\_TIMESTEP**  
**\*CONTROL\_TIMESTEP**

LS-DYNA's implicit mode may be activated in two ways. Using the **\*CONTROL\_IMPLICIT\_GENERAL** keyword, a simulation may be flagged to run entirely in implicit mode. Alternatively, an explicit simulation may be seamlessly switched into implicit

mode at the termination time using the **\*INTERFACE\_SPRINGBACK\_SEAMLESS** keyword. The seamless switching feature is intended to simplify metal forming springback calculations, where the forming phase can be run in explicit mode, followed immediately by an implicit static springback simulation. In case of difficulty, restart capability is supported. Eight keywords are

available to support implicit analysis. Default values are carefully selected to minimize input necessary for most simulations. These are summarized below:

- \*CONTROL\_IMPLICIT\_GENERAL  
Activates implicit mode, selects time step size.
- \*CONTROL\_IMPLICIT\_INERTIA\_RELIEF  
Allows linear analysis of models with rigid body modes.
- \*CONTROL\_IMPLICIT\_SOLVER  
Selects parameters for solving system of linear equations  $[K]\{x\}=\{f\}$ .
- \*CONTROL\_IMPLICIT\_SOLUTION  
Selects linear or nonlinear solution method, convergence tolerances.
- \*CONTROL\_IMPLICIT\_AUTO  
Activates automatic time step control.
- \*CONTROL\_IMPLICIT\_DYNAMICS  
Activates and controls dynamic implicit solution using Newmark method.
- \*CONTROL\_IMPLICIT\_EIGENVALUE  
Activates and controls eigenvalue analysis.
- \*CONTROL\_IMPLICIT\_MODES  
Activates and controls computation of constraint and attachment modes.
- \*CONTROL\_IMPLICIT\_STABILIZATION  
Activates and controls artificial stabilization for multi-step springback.

**\*CONTROL\_ACCURACY**

Purpose: Define control parameters that can improve the accuracy of the calculation.

Card 1            1            2            3            4            5            6            7            8

Variable	OSU	INN	PIDOSU					
Type	I	I	I					
Default	0 (off)		optional					

**VARIABLE****DESCRIPTION**

OSU	Global flag for 2nd order objective stress updates (See Remark 1 below). Generally, for explicit calculations only those parts undergoing large rotations, such as rolling tires, need this option. Objective stress updates can be activated for a subset of part IDs by defining the part set in columns 21-30. EQ.0: Off (default) EQ.1: On
INN	Invariant node numbering for shell and solid elements. (See Remarks 2 and 3 below). EQ.-4: On for both shell and solid elements except triangular shells EQ.-2: On for shell elements except triangular shells EQ. 1: Off (default for explicit) EQ. 2: On for shell and thick shell elements (default for implicit) EQ. 3: On for solid elements EQ. 4: On for shell, thick shell, and solid elements
PIDOSU	Part set ID for objective stress updates. If this part set ID is given only those part IDs listed will use the objective stress update; therefore, OSU is ignored.

**Remarks:**

1. Second order objective stress updates are occasionally necessary. Some examples include spinning bodies such as turbine blades in a jet engine, high velocity impacts generating large strains in a few time steps, and large time step sizes due to mass scaling in metal forming. There is a significantly added cost which is due in part to the added cost of the second order terms in the stress update when the Jaumann rate is used and the

need to compute the strain-displacement matrix at the mid-point geometry. This option is available for one point brick elements, the selective-reduced integrated brick element which uses eight integration points, the fully integrated plane strain and axisymmetric volume weighted (type 15) 2D solid elements, the thick shell elements, and the following shell elements: Belytschko-Tsay, Belytschko-Tsay with warping stiffness, Belytschko-Chiang-Wong, S/R Hughes-Liu, and the type 16 fully integrated shell element.

2. Invariant node numbering for shell and thick shell elements affects the choice of the local element shell coordinate system. The orientation of the default local coordinate system is based on the shell normal vector and the direction of the 1-2 side of the element. If the element numbering is permuted, the results will change in irregularly shaped elements. With invariant node numbering, permuting the nodes shifts the local system by an exact multiple of 90 degrees. In spite of its higher costs [ $<5\%$ ], the invariant local system is recommended for several reasons. First, element forces are nearly independent of node sequencing; secondly, the hourglass modes will not substantially affect the material directions; and, finally, stable calculations over long time periods are achievable. The INN parameter has no effect on thick shell form 2 which is always invariant and thick shell form 3 which is never invariant.
3. Invariant node numbering for solid elements is available for anisotropic materials only. This option has no effect on solid elements of isotropic material. This option is recommended when solid elements of anisotropic material undergo significant deformation.

**\*CONTROL\_ADAPSTEP**

Purpose: Define control parameters for contact interface force update during each adaptive cycle.

Card 1            1            2            3            4            5            6            7            8

Variable	FACTIN	DFACTR							
Type	F	F							
Default	1.0	0.01							

**VARIABLE****DESCRIPTION**

FACTIN            Initial relaxation factor for contact force during each adaptive remesh. To turn this option off set FACTIN=1.0. Unless stability problems occur in the contact, FACTIN=1.0 is recommended since this option can create some numerical noise in the resultant tooling forces. A typical value for this parameter is 0.10.

DFACTR            Incremental increase of FACTIN during each time step after the adaptive step. FACTIN is not allowed to exceed unity. A typical value might be 0.01.

**Remarks:**

- This command applies to contact with thickness offsets including contact types:
  - \*CONTACT\_FORMING\_....,
  - \*CONTACT\_NODES\_TO\_SURFACE,
  - \*CONTACT\_SURFACE\_TO\_SURFACE,
  - \*CONTACT\_ONE\_WAY\_SURFACE\_TO\_SURFACE.

**\*CONTROL\_ADAPTIVE**

Purpose: Activate adaptive meshing. The parts which are adaptively meshed are defined by \*PART. See remarks below.

Card 1            1            2            3            4            5            6            7            8

Variable	ADPFREQ	ADPTOL	ADPOPT	MAXLVL	TBIRTH	TDEATH	LCADP	IOFLAG
Type	F	F	I	I	F	F	I	I
Default	none	1.0E20	1	3	0.0	1.0E20	0	0

**(This card is optional).**

Card 2            1            2            3            4            5            6            7            8

Variable	ADPSIZE	ADPASS	IREFLG	ADPENE	ADPTH	MEMORY	ORIENT	MAXEL
Type	F	I	I	F	F	I	I	I
Default		0	0	0.0	inactive	inactive	0	inactive

**(This card is optional).**

Card 3            1            2            3            4            5            6            7            8

Variable	IADPN90	IADPGH	NCFREQ	IADPCL	ADPCTL	CBIRTH	CDEATH	LCLVL
Type	I	I	I	I	F	F	F	F
Default	0	0	none	1	none	0.0	1.0E20	

(This card is optional)

Card 4            1            2            3            4            5            6            7            8

Variable	CNLA			MMM2D	ADPERR			
Type	F			I	I			
Default	0			0	0			

<u>VARIABLE</u>	<u>DESCRIPTION</u>
ADPFREQ	Time interval between adaptive refinements, see Figure 11.1.
ADPTOL	Adaptive error tolerance in degrees for ADPOPT set to 1 or 2 below. If ADPOPT is set to 8, ADPTOL is the characteristic element size.
ADPOPT	<p>Adaptive options:</p> <p>EQ.1: angle change in degrees per adaptive refinement relative to the surrounding elements for each element to be refined.</p> <p>EQ.2: total angle change in degrees relative to the surrounding element for each element to be refined. For example, if the adptol=5 degrees, the element will be refined to the second level when the total angle change reaches 5 degrees. When the angle change is 10 degrees the element will be refined to the third level.</p> <p>EQ.4: adapts when the element error in the energy norm (<math>\Delta e</math>) exceeds ADPTOL/100 times the mean energy norm within the part, which is estimated as:</p> $\Delta e = \left( \int_{\Omega_k} \ \Delta \sigma\ ^2 / E d\Omega \right)^{\frac{1}{2}}$ <p>where E is is Young's modular. The error of the stresses <math>\Delta \sigma</math> is defined as the difference between the the recovered solution <math>\sigma^*</math> and the numerical solution <math>\sigma^h</math>, i.e. <math>\Delta \sigma \equiv \sigma^* - \sigma^h</math>. Various recovery techniques for <math>\sigma^*</math> and error estimators for <math>\Delta e</math> are defined by APTERR. This options works for shell types 2,4,16,18,20.</p> <p>EQ.7: 3D r-adaptive remeshing for solid elements. Solid element type 13, a tetrahedron, and 3-D EFG type 41, are used in the adaptive remeshing process. A completely new mesh is generated which is initialized from the old mesh using a least squares approximation. The mesh size is currently based on the minimum and maximum edge lengths defined on the *CONTROL_REMESHING keyword input. This option remains</p>



VARIABLE	DESCRIPTION
	<p>under development, and, we are not sure of its reliability on complex geometries.</p> <p>EQ.8: 2D r-adaptive remeshing for axisymmetric and plane strain solid elements. A completely new mesh is generated which is initialized from the old mesh using a least squares approximation. The mesh size is currently based on the value, ADPTOL, which gives the characteristic element size. This option is based on earlier work by Dick and Harris [1992]. If ADPOPT is negative, then self-contacting material <u>will not</u> be merged together. The self-merging is often preferred since it eliminates sharp folds in the boundary; however, if the sharp fold is being simulated unexpected results are generated.</p>
MAXLVL	<p>Maximum number of refinement levels. Values of 1, 2, 3, 4, ... allow a maximum of 1, 4, 16, 64, ... elements, respectively, to be created for each original element. The refinement level can be overridden by *DEFINE_BOX_ADAPTIVE, or *DEFINE_SET_ADAPTIVE.</p>
TBIRTH	<p>Birth time at which the adaptive remeshing begins, see Figure 11.1.</p>
TDEATH	<p>Death time at which the adaptive remeshing ends, see Figure 11.1.</p>
LCADP	<p>Adaptive interval is changed as a function of time given by load curve ID, LCADP. If this option is nonzero, the ADPFREQ will be replaced by LCADP. The x-axis is time and the y-axis is the varied adaptive time interval.</p>
IOFLAG	<p>Flag to generate adaptive mesh at exit including *NODE, *ELEMENT, *SHELL, and *BOUNDARY_, *CONTACT_NODE_, and *CONSTRAINED_ADAPTIVITY, to be saved in the file, adapt.msh.</p> <p>EQ.1: generate adaptive mesh.</p>
ADPSIZE	<p>Minimum element size to be adapted based on element edge length. If undefined the edge length limit is ignored.</p> <p>LT.0: absolute value defines the minimum characteristic element length to be adapted based on square root of the element area, i.e., instead of comparing the shortest element edge with ADPSIZE, it compares the square root of the element area with  ADPSIZE  whenever ADPSIZE is defined by a negative value.</p>
ADPASS	<p>One or two pass adaptivity flag:</p> <p>EQ.0: two pass adaptivity as shown in Figure 11.2a,</p> <p>EQ.1: one pass adaptivity as shown in Figure 11.2b.</p>
IREFLG	<p>Uniform refinement level. A value of 1, 2, 3 ... allow 4, 16, 64 ...</p>

**VARIABLE****DESCRIPTION**

elements, respectively, to be created uniformly for each original element. If negative, |IREFLG| is taken as a load curve ID. With the curve option, the abscissa values define the refinement time, and the ordinate values define the minimum element size. Only one refinement level is performed per time step. An advantage of the load curve option is that the mesh is adapted to honor the minimum element size, but with the uniform option, IREFLG>0, this is not possible.

**Note: If the element size defined with \*DEFINE\_CURVE is positive, the element size will override the element size defined with \*CONTROL\_ADAPTIVE and \*DEFINE\_SET\_ADAPTIVE. Also, if the element size defined with \*DEFINE\_CURVE is negative the element size is used for refinement only.**

ADPENE	Adapt the mesh when the contact surfaces approach or penetrate the tooling surface depending on whether the value of ADPENE is positive (approach) or negative (penetrates), respectively. The tooling adaptive refinement is based on the curvature of the tooling. If ADPENE is positive the refinement generally occurs before contact takes place; consequently, it is possible that the parameter ADPASS can be set to 1 in invoke the one pass adaptivity.
ADPTH	<p>EQ.0.0 This parameter is ignored</p> <p>GT.0.0 Absolute shell thickness level below which adaptive remeshing should began.</p> <p>LT.0.0 Element thickness ratio. If the ratio of the element thickness to the original element thickness is less than the absolute value of ADPTHK, the element will be refined.</p> <p>This option works only if ADPTOL is nonzero. If thickness based adaptive remeshing is desired without angle changes, then, set ADPTOL to a large angle.</p>
MEMORY	This flag can have two meanings depending on whether the memory environmental variable is or is not set. The command "setenv LSTC_MEMORY auto" sets the memory environmental variable which causes LS-DYNA to expand memory automatically. Note that automatic memory expansion is not always 100% reliable depending on the machine and operating system level; consequently, it is not yet the default. To see if this is set on a particular machine type the command "env". If the environmental variable <u>is not set</u> then when memory usage reaches this percentage, MEMORY, further adaptivity is prevented to avoid exceeding the memory specified at execution time. Caution is necessary since memory usage is checked after each adaptive step, and, if the memory usage increases by more than the residual percentage,

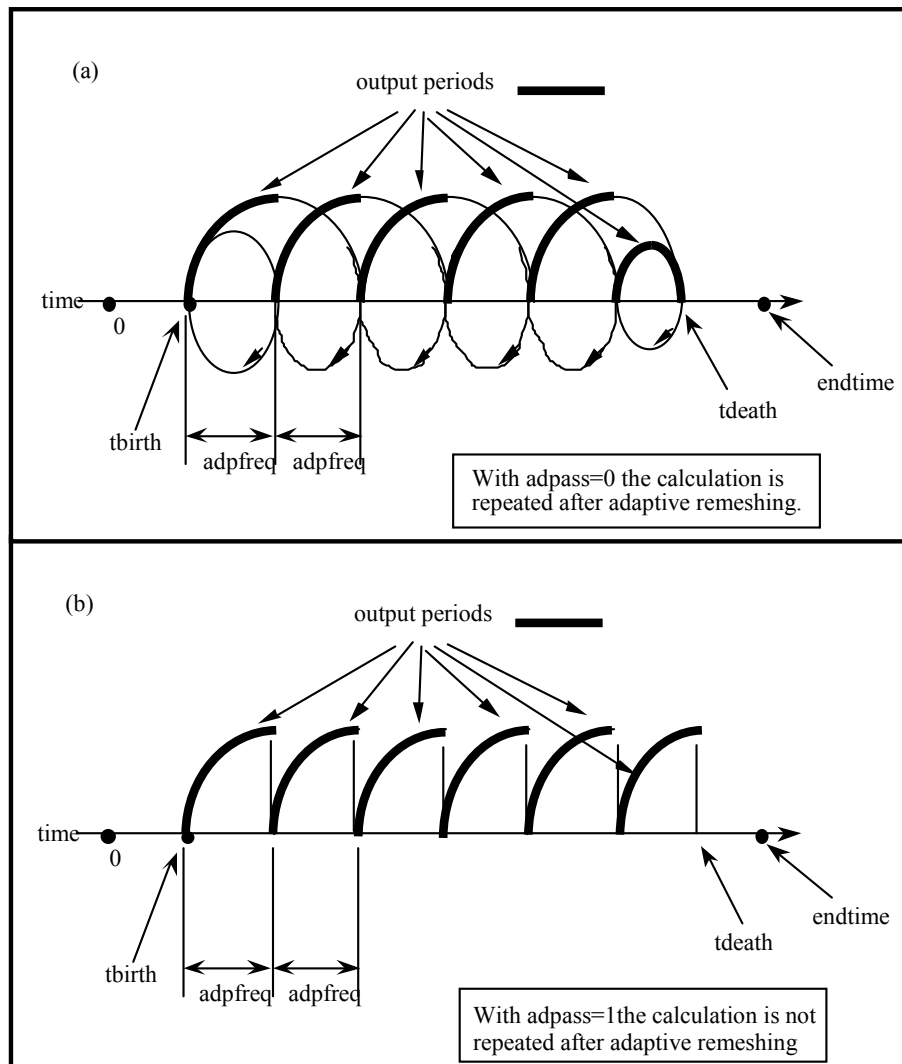
VARIABLE	DESCRIPTION
	<p>100-PERCENT, the calculation will terminate.</p> <p>If the memory environmental variable <u>is set</u> then when the number of words of memory allocated reaches or exceeds this value, MEMORY, further adaptivity is stopped.</p>
ORIENT	<p>This option applies to the FORMING contact option only. If this flag is set to one (1), the user orientation for the contact interface is used. If this flag is set to zero (0), LS-DYNA sets the global orientation of the contact surface the first time a potential contact is observed after the birth time. If slave nodes are found on both sides of the contact surface, the orientation is set based on the principle of "majority rules". Experience has shown that this principle is not always reliable.</p>
MAXEL	<p>Adaptivity is stopped if this number of elements is exceeded.</p>
IADPN90	<p>Maximum number of elements covering 90 degree of radii. See Remark 6.</p>
IADPGH	<p>Fission flag for neighbor splitting. EQ.0: split all neighbor elements EQ.1: do not split neighbor elements</p>
NCFREQ	<p>Frequency of fission to fusion steps. For example, if NCFREQ=4, then fusion will occur on the fourth, eighth, twelfth, etc., fission steps, respectively. If this option is used NCFREQ&gt;1 is recommended.</p>
IADPCL	<p>Fusion will not occur until the fission level reaches IADPCL. Therefore, if IADPCL=2, MAXLVL=5, any element can be split into 256 elements. If the surface flattens out, the number of elements will be reduced if the fusion option is active, i.e., the 256 elements can be fused and reduced to 16.</p>
ADPCTL	<p>Adaptivity error tolerance in degrees for activating fusion. It follows the same rules as ADPOPT above.</p>
CBIRTH	<p>Birth time for adaptive fusion. If ADPENE&gt;0, look-ahead adaptivity is active. In this case, fission, based on local tool curvature, will occur while the blank is still relatively flat. The time value given for CBIRTH should be set to a time later in the simulation after the forming process is well underway.</p>
CDEATH	<p>Death time for adaptive fusion.</p>
LCLVL	<p>Load curve ID of a curve that defines the maximum refinement level as a function of time</p>

<b>VARIABLE</b>	<b>DESCRIPTION</b>
CNLA	Limit angle for corner nodes. See Remark 7.
MMM2D	If non-zero, common boundaries of all adapted materials will be merged. Only for 2D r-adaptivity
ADPERR	3-digit number, as “XYY”, where “X” and “YY” define the options for the recovery techniques and the error estimators, respectively, X EQ.0: superconvergent patch recovery (SPR) (default); EQ.1: the least square fit of the stress to the nodes (Global L2); EQ.2: error density SPR, as $\Delta \tilde{e} = \Delta e / \text{Area}_{\text{element}}$ ; EQ.3 self-weighted SPR, as $\Delta \hat{e} = \sqrt{\Delta e \times e}$ YY EQ.00: energy norm (default); EQ.01 Cauchy $\sigma_x$ ; EQ.02 $\sigma_y$ ; EQ.03 $\sigma_z$ ; EQ.04 $\tau_{xy}$ ; EQ.05 $\tau_{yz}$ ; EQ.06 $\tau_{zx}$ ; EQ.07 effective plastic strain, $\epsilon^{\text{ep}}$ ; EQ.08 pressure; EQ.09 von Mises; EQ.10 principal deviator stress $s_{11}$ ; EQ.11 $s_{22}$ ; EQ.12 $s_{33}$ ; EQ.13 Tresca; EQ.14 principal stress $\sigma_{11}$ ; EQ.15 $\sigma_{22}$ ; EQ.16 $\sigma_{33}$ ; EQ.20 user subroutine: “uadpval” to extract the numerical solutions for recovery, and “uadpnorm” to provide an error estimator.

**Remarks:**

1. D3DUMP and RUNRSF files contain all information necessary to restart an adaptive run. This did not work in version 936 of LS-DYNA.
2. Card 2 input is optional and is not required.
3. In order for this control card to work, the flag ADPOPT=1 must be set in the \*PART definition. Otherwise, adaptivity will not function.
4. In order for adaptivity to work optimally, the parameter SNLOG=1, must be set on Optional Control Card B in the \*CONTACT Section. On disjoint tooling meshes the contact option \*CONTACT\_FORMING\_..... is recommended.
5. A file adapt.rid is left on disk after the adaptive run is completed. This file contains the root ID of all elements that are created during the calculation, and it does not need to be kept if it is not used in post-processing.
6. For springback analysis, IADPN90 is usually chosen between 4 and 6.

7. When using 2D r-adaptive remeshing, the generated new mesh should have a node at each corner so that corners are not smoothed. By default, the mesher will assume a corner wherever the interior angle between adjacent edges is less than 110 degrees. Setting CNLA larger than 110 enables angles larger than 110 to be corners. Care should be taken to avoid an unnecessarily large value of CNLA as this may prevent the mesher from generating smooth meshes.



**Figure 11.1.** At time= $t_{\text{birth}}$  the adaptive calculation begins. After computing for a time interval  $\text{adpfreq}$  error norms are computed. If  $\text{ADPASS}=0$ , then the mesh that existed at time= $t_{\text{birth}}$  is refined based on the computed error norms. With the new mesh, the calculation continues to time= $t_{\text{birth}}+2 \times \text{adpfreq}$  where the error norms are again computed. The mesh that existed at time= $t_{\text{birth}}+\text{adpfreq}$  is refined and the calculation continues to time= $t_{\text{birth}}+3 \times \text{adpfreq}$ , and so on. However, if  $\text{ADPASS}=1$ , then the mesh that exist at time = $t_{\text{birth}}+\text{adpfreq}$  is refined and the calculation continues. Errors that develop between adaptive

remeshing are preserved. Generally, ADPASS=0 is recommended but this option is considerably more expensive.

**\*CONTROL\_ADAPTIVE\_CURVE**

Purpose: To refine the element mesh along a curve. All curves defined by the keyword \*DEFINE\_CURVE\_TRIM are used in the refinement. This option provides additional refinement to that created by \*CONTRO\_ADAPTIVE. Additionally, mesh refinement along a predefined curve with specific distance/range is enabled when this keyword is used together with \*DEFINE\_CURVE\_TRIM\_3D, by activating the variable TCTOL.

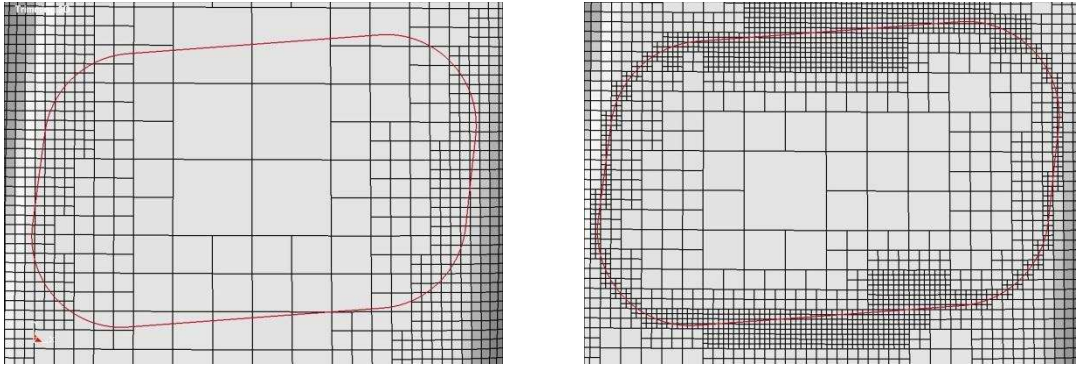
Card 1            1            2            3            4            5            6            7            8

Variable	IDSET	ITYPE	N	SMIN	ITRIOPT			
Type	I	I	I	F	I			

<u>VARIABLE</u>	<u>DESCRIPTION</u>
IDSET	Set ID
ITYPE	Set type: EQ.1: IDSET is shell set ID. EQ.2: IDSET is part set ID.
N	Refinement option: EQ.1: Refine until there are no adaptive constraints remaining in the element mesh around the curve, subjected to the maximum refinement level of 5. GT.1: Refine no more than N levels.
SMIN	If the element dimension is smaller than this value, do not refine.
ITRIOPT	Option to refine an enclosed area of a trim curve. EQ.0: Refine the elements along the trim curve. EQ.1: Refine the elements along the trim curve and enclosed by the trim curve.

**Remarks:**

1. Keyword manual pages \*DEFINE\_CURVE\_TRIM provides more details regarding mesh refinement along a curve within a user specified distance/range, useful in performing a flanging simulation in a multistage stamping die process simulation.



**Figure 11.2.** Refinement along a curve.



**\*CONTROL\_ADAPTIVE\_SOLID\_TO\_SPH**

Purpose: Define an adaptive option to switch solid elements that reach a failure criterion into SPH elements.

Card 1            1            2            3            4            5            6            7            8

Variable	PID	ITYPE	N					
Type	I	I	I					

<u>VARIABLE</u>	<u>DESCRIPTION</u>
PID	Part Set ID or Part ID.
ITYPE	Part type: EQ.1: PID is a part set ID. EQ.2: PID is a part ID.
N	Refinement option: EQ.1: Refine one solid element into one SPH element. EQ.2: Refine one solid element into two SPH elements. EQ.3: Refine one solid element into four SPH elements.

# \*CONTROL

\*CONTROL\_ALE

## \*CONTROL\_ALE

Purpose: Set global control parameters for the Arbitrary Lagrange-Eulerian (ALE) and Eulerian calculations. This is required when ELFORM = 5, 6, 7, 11, and 12.

Card 1            1            2            3            4            5            6            7            8

Variable	DCT	NADV	METH	AFAC	BFAC	CFAC	DFAC	EFAC
Type	I	I	I	F	F	F	F	F
Default	1	0	1	0	0	0	0	0

Card 2            1            2            3            4            5            6            7            8

Variable	START	END	AAFAC	VFACT	PRIT	EBC	PREF	NSIDEBC
Type	F	F	F	F	F	I	F	I
Default	0	1.0E+20	1	1.0E-06	0.0	0	0.0	none

### Optional Card 3

Card 3            1            2            3            4            5            6            7            8

Variable	NCPL	NBKT	IMASCL	CHECKR	BEAMIN	INIJWL	PDIFMX	
Type	I	I	I	F	F	I	F	
Default	1	50	0	0.0	0.0	0	0.0	

---

<u>VARIABLE</u>	<u>DESCRIPTION</u>
DCT	Flag to invoke alternate advection logic. Formerly flag to control default continuum treatment: NE.-1: Use default advection logic. EQ.-1: Use alternate advection logic; generally recommended, especially for simulation of explosives (see Remark 9).
NADV	Number of cycles between advections (almost always set to 1).
METH	Advection method: EQ.1: donor cell + HIS (Half-Index-Shift, first order accurate), EQ.2: Van Leer + HIS (Half-Index-Shift, second order). EQ.-2: Van Leer + HIS, with the monotonicity condition relaxed during advection process to better preserve *MAT_HIGH_EXPLOSIVE_BURN material interface. (See Remark 10) EQ.3: donor cell + HIS, first order accurate, conserving total energy over each advection step instead of conserving internal energy (See Remark 5).
AFAC	ALE smoothing weight factor - Simple average: EQ.-1: turn smoothing off. (See Remark 6).
BFAC	ALE smoothing weight factor – Volume weighting
CFAC	ALE smoothing weight factor – Isoparametric
DFAC	ALE smoothing weight factor – Equipotential
EFAC	ALE smoothing weight factor – Equilibrium
START	Start time for ALE smoothing
END	End time for ALE smoothing
AAFAC	ALE advection factor (donor cell options, default=1.0)
VFACT	Volume fraction limit for stresses in single material and void formulation. All stresses are set to zero for elements with lower volume fraction than VFACT. EQ.0.0: set to default 1.0E-06.
PRIT	A flag to turn on or off the pressure equilibrium iteration option for multi-material elements (See Remark 1). EQ.0: Off (default) EQ.1: On

---

<b>VARIABLE</b>	<b>DESCRIPTION</b>
EBC	Automatic Eulerian boundary condition (See Remark 2). EQ.0: Off EQ.1: On with stick condition EQ.2: On with slip condition
PREF	Reference pressure applied to the free surfaces of the ALE mesh boundary. (See Remark 3).
NSIDEBC	A node set ID (NSID) which is to be excluded from the EBC constraint.
NCPL	Number of Lagrangian cycles between coupling calculations. This is typically done every cycle; therefore, its default is 1. This is on optional card 3.
NBKT	Number of Lagrangian cycles between global bucket-sort searches to locate the position of the Lagrangian structure (mesh) relative to the ALE fluid (mesh). Default is 50. This is on optional card 3.
IMASCL	A flag for turning ON/OFF mass scaling for ALE parts. The global mass scaling control (parameter DT2MS under *CONTROL_TIMESTEP card) must be ON. If the run dt is lower than the mass scaling dt, then IMASCL has the following effects: EQ.0: (Default) No mass scaling for ALE parts. Print out maximum 20 warnings. EQ.1: No mass scaling for ALE parts. Stop the run. EQ.2: Do mass scaling for ALE parts (the result may not be correct due to this scaling).
CHECKR	A parameter for reducing or eliminating an ALE pressure locking pattern. It may range from 0.01 to 0.1 (See Remark 4).
BEAMIN	Flag to align the dynamics of plain strain and axisymmetric beams in 2D FSI ALE models to their shell counterparts in 3D FSI ALE models: EQ.0.0: Off (default) EQ.1.0: On
INIJWL	Flag to initialize to PREF the pressures of ALE groups with *EOS_2 or *EOS_14: EQ.0: Off (default) EQ.1: On
PDIFMX	Maximum of pressure difference between neighboring ALE elements under which the stresses are zeroed out: EQ.0: Off (default) GT.1: On

**Remarks:**

1. By default, all materials in a multi-material element are assumed to undergo the same element averaged strain rates. This assumption may not be robust when mixing materials with very different compressibility. In this case, an assumption of pressure equilibrium (PRIT=1) in the element may be more appropriate.
2. This option, used for EULER formulations, automatically defines velocity boundary condition constraints for the user. The constraints, once defined, are applied to all nodes on free surfaces of an Eulerian domain. For problems where the normal velocity of the material at the boundary is zero such as injection molding problems, the automatic boundary condition parameter is set to 2. This will play the same role as the nodal single point constraint. For EBC=1, the material velocity of all free surface nodes of an Eulerian domain is set to zero.
3. The PREF definition is equivalent to using the \*LOAD\_SEGMENT card to provide pressure loading on the free surfaces of all ALE or Eulerian mesh(es) in a model. This cannot be used to initialize the internal pressure of the material (that must be done via the \*EOS\_ or \*BOUNDARY\_AMBIENT\_EOS cards).
4. Due to one point integration, ALE elements may experience a spatial instability in the pressure field referred to as checker boarding. CHECKR is a scale for diffusive flux calculation to alleviate this problem.
5. Generally, it is not possible to conserve both momentum and kinetic energy (KE) at the same time. Typically, internal energy (IE) is conserved and KE may not be. This may result in some KE loss (hence, total energy loss). For many analyses this is tolerable, but for airbag application, this may lead to the reduction of the inflating potential of the inflator gas. METH=3 tries to eliminate this loss in KE over the advection step by storing any loss KE under IE, thus conserving total energy of the system.
6. All the smoothing factors (AFAC, BFAC, CFAC, DFAC, EFAC) are generally most applicable to ELFORM=5 (single material ALE formulation).
7. Although this card has many parameters, only a few are required definitions. Typically, one can try, as a first run, setting NADV=1, METH=1, AFAC=-1 and the rest as "0". Sometimes when needed, PREF may be defined. This is adequate for most cases. METH may be changed to 2 or 3 later depending on the physics of the problem during fine-tuning of the model.
8. Due to the fact that we have internal forces at the nodes, while the pressure is stored at the element center, sometimes there is a "checker-board pattern" in the pressure distribution. It is a kind of locking effect that normally occurs only in problems having very small volumetric strains, i.e., at small pressures. "CHECKR" is designed for alleviating this problem.
9. DCT is an obsolete (unused) flag in pre-R5 releases of 971 but can be used starting with the R5 release to invoke an alternate advection scheme. DCT=-1 is recommended over

the default scheme, especially for simulating explosives and includes the following major changes:

- (a) Relaxes an artificial limit on the expansion ratio limit. The default limit improves stability in some situations but can overestimate the explosive impulse.
  - (b) Corrects redundant out-flux of material at corner elements. The redundancy can lead to negative volume.
  - (c) Removes several artificial constraints in the advection which were originally implemented to assist in stability but are no longer needed.
10. The METH=-2 advection type is the same as METH=2 with only one exception. It employs a looser constraint on monotonicity requirement during ALE advection. When METH=2, for each advection process along three directions (front/back, top/bottom, left/right), the maximum/minimum values for advected history variables in the three elements along that direction are capped. METH=-2 relaxed the monotonicity condition so that the advected value is capped at the maximum/minimum value in the element itself and its neighboring 26 elements. This option, in certain conditions, can better preserve the material interface for materials defined with \*MAT\_HIGH\_EXPLOSIVE\_BURN.

## \*CONTROL\_BULK\_VISCOSITY

Purpose: Reset the default values of the bulk viscosity coefficients globally. This may be advisable for shock wave propagation and some materials. Bulk viscosity is used to treat shock waves. A viscous term  $q$  is added to the pressure to smear the shock discontinuities into rapidly varying but continuous transition regions. With this method the solution is unperturbed away from a shock, the Hugoniot jump conditions remain valid across the shock transition, and shocks are treated automatically.

Card            1            2            3            4            5            6            7            8

Variable	Q1	Q2	TYPE	BTYPE				
Type	F	F	I	I				
Default	1.5	.06	1	0				

**VARIABLE****DESCRIPTION**

Q1	Default quadratic viscosity coefficient.
Q2	Default linear viscosity coefficient.
TYPE	Default bulk viscosity type, IBQ (Default=1) EQ. -2: standard (also types 2, 4, 10, 16, and 17). With this option the internal energy dissipated by the viscosity in the shell elements is computed and included in the overall energy balance. EQ. -1: standard (also types 2, 4, 10, 16, and 17 shell elements). The internal energy is not computed in the shell elements. EQ.+1: standard. Solid elements only and internal energy is always computed and included in the overall energy balance. EQ.+2: Richards-Wilkins. Two-dimensional plane strain and axisymmetric solid elements only. Internal energy is always computed and included in the overall energy balance.
BTYPE	Beam bulk viscosity type (Default=0) EQ. 0: The bulk viscosity is turned off for beams. EQ. 1: The bulk viscosity is turned on for beam types 1 and 11. The energy contribution is not included in the overall energy balance. EQ. 2: The bulk viscosity is turned on for beam type 1 and 11. The energy contribution is included in the overall energy balance.

**Remarks:**

The bulk viscosity creates an additional additive pressure term given by:

$$q = \rho l (Q_1 l \dot{\epsilon}_{kk}^2 - Q_2 a \dot{\epsilon}_{kk}) \quad \text{if } \dot{\epsilon}_{kk} < 0$$

$$q = 0 \quad \text{if } \dot{\epsilon}_{kk} \geq 0$$

where  $Q_1$  and  $Q_2$  are dimensionless input constants which default to 1.5 and .06, respectively, and  $l$  is a characteristic length given as the square root of the area in two dimensions and as the cube root of the volume in three,  $a$  is the local sound speed,  $Q_1$  defaults to 1.5 and  $Q_2$  defaults to .06. See Chapter 21 in the LS-DYNA Theory Manual for more details.

The Richards-Wilkins, see [Richards 1965, Wilkins 1976], bulk viscosity considers the directional properties of the shock wave. This has the effect of turning off the bulk viscosity in converging geometries minimizing the effects of “q-heating”. The standard option is active whenever the volumetric strain rate is undergoing compression even though no shock waves are present.



**\*CONTROL\_CHECK\_{OPTION}**

Available options include:

<BLANK>

**SHELL**

Purpose: Check for various problems in the mesh.

(OPTION = **SHELL**) (include one card for each part to be checked, or use part set ID for PSID)

Card 1            1            2            3            4            5            6            7            8

Variable	PSID	IFAUTO	CONVEX	ADPT	ARATIO	ANGLE	SMIN	
Type	I	I	I	I	F	F	F	
Default	0	0	1	1	0.25	150.0	0.0	

<u>VARIABLE</u>	<u>DESCRIPTION</u>
PSID	Part/part set ID to be checked: EQ.0: do not check GT.0: part ID LT.0: part set ID.
IFAUTO	Flag to automatically correct bad elements: EQ.0: write warning message only EQ.1: fix bad element, write message
CONVEX	Check element convexity (internal angles less than 180 degrees) EQ.0: do not check EQ.1: check
ADPT	Check adaptive constraints EQ.0: do not check EQ.1: check
ARATIO	Minimum allowable aspect ratio. Elements which do not meet minimum aspect ratio test will be treated according to IFAUTO above.
ANGLE	Maximum allowable internal angle. Elements which fail this test will be treated according to IFAUTO above.

---

<u>VARIABLE</u>	<u>DESCRIPTION</u>
SMIN	Minimum element size. Elements which fail this test will be treated according to IFAUTO above.

**Remarks:**

1. For the SHELL option, shell element integrity checks which have been identified as important in metal forming applications are performed. These checks can improve springback convergence and accuracy. This option will repair bad elements created, for example, during trimming operations.
2. If the convexity test is activated, all failed elements will be fixed regardless of IFAUTO.
3. In addition to illegal constraint definitions (slave which is also a master), checks are performed for mesh connectivities which have been found to cause convergence trouble in implicit springback applications.
4. Variable SMIN should be set to 1/4 to 1/3 of smallest pre-trim element length. In an example below, smallest element length pre-trim is 0.6mm, which makes SMIN to be 0.18:  

```
*CONTROL_CHECK_SHELL  
1,1,1,1,0.25,150.0,0.18  
$ smin=(0.25~0.3)*smallest pre-trim element length, which is ~0.6 mm.
```
5. Shell checking is done during the input phase (in sprinback input deck) in LS-DYNA R5 Revision 63063 and prior releases. After the Revision, it is done after trimming is completed. Therefore the keyword should be included in a trimming input deck.

**\*CONTROL\_COARSEN**

Purpose: Adaptively de-refine (coarsen) a shell mesh by selectively merging four adjacent elements into one. Adaptive constraints are added and removed as necessary.

Card 1            1            2            3            4            5            6            7            8

Variable	ICOARSE	ANGLE	NSEED	PSID	SMAX			
Type	I	F	I	I	F			
Default	0	none	0	0	0			

Card 2            1            2            3            4            5            6            7            8

Variable	N1	N2	N3	N4	N5	N6	N7	N8
Type	I	I	I	I	I	I	I	I
Default	0	0	0	0	0	0	0	0

**VARIABLE**

**DESCRIPTION**

ICOARSE

Coarsening flag:

EQ.0: do not coarsen (default),

EQ.1: coarsen mesh at beginning of simulation for forming model

EQ.2: coarsen mesh at beginning of simulation for crash model

ANGLE

Allowable angle change between neighboring elements. Adjacent elements which are flat to within ANGLE degrees are merged. (Suggested starting value = 8.0 degrees)

NSEED

Number of seed nodes (optional).

EQ.0: use only automatic searching.

EQ.n: also search starting with node IDs given below (maximum = 8 nodes)

PSID

Part set ID. All the parts defined in this set will be prevented from been coarsened.

<u>VARIABLE</u>	<u>DESCRIPTION</u>
SMAX	Maximum element size. For ICOARSE=2, no elements larger than this size will be created.
N1...N8	Optional list of seed node IDs for extra searching. If no seed nodes are specified, leave card 2 blank.

**Remarks:**

1. Coarsening is performed at the start of a simulation. The first plot state represents the coarsened mesh. By setting the termination time to zero and including the keyword \*INTERFACE\_SPRINGBACK\_LSDYNA a keyword input deck can be generated containing the coarsened mesh.
2. By default, an automatic search is performed to identify elements for coarsening. In some meshes, isolated regions of refinement may be overlooked. Seed nodes can be identified in these regions to assist the automatic search. Seed nodes identify the central node of a four-element group which is coarsened into a single element if the angle criterion is satisfied.
3. The keyword \*DEFINE\_BOX\_COARSEN can be used to indicate regions of the mesh which are protected from coarsening.

**\*CONTROL\_CONTACT****\*CONTROL****\*CONTROL\_CONTACT**

Purpose: Change defaults for computation with contact surfaces.

Card 1            1            2            3            4            5            6            7            8

Variable	SLSFAC	RWPNAL	ISLCHK	SHLTHK	PENOPT	THKCHG	ORIEN	ENMASS
Type	F	F	I	I	I	I	I	I
Default	.1	none	1	0	1	0	1	0

Card 2            1            2            3            4            5            6            7            8

Variable	USRSTR	USRFRC	NSBCS	INTERM	XPENE	SSTHK	ECDT	TIEDPRJ
Type	I	I	I	I	F	I	I	I
Default	0	0	10-100	0	4.0	0	0	0

**Card 3 is optional. The following parameters are the default values used by parts in automatic contacts. These frictional coefficients apply only to contact types: SINGLE\_SURFACE, AUTOMATIC\_GENERAL, AUTOMATIC\_SINGLE\_SURFACE, AUTOMATIC\_NODES\_TO\_..., AUTOMATIC\_SURFACE\_..., and AUTOMATIC\_ONE\_WAY\_..., and ERODING\_SINGLE\_SURFACE. Also see \*CONTACT and \*PART. Note that these default values will override the values specified for these contact types in the \*CONTACT section.**

Card 3            1            2            3            4            5            6            7            8

Variable	SFRIC	DFRIC	EDC	VFC	TH	TH_SF	PEN_SF	
Type	F	F	F	F	F	F	F	
Default	0.0	0.0	0.0	0.0	0.0	0.0	0.0	

# \*CONTROL

\*CONTROL\_CONTACT

Card 4 is optional. If this card is defined, then Card 3 above must be included. A blank card may be inserted for Card 3.

Card 4            1            2            3            4            5            6            7            8

Variable	IGNORE	FRCENG	SKIPRWG	OUTSEG	SPOTSTP	SPOTDEL	SPOTHIN	
Type	I	I	I	I	I	I	F	
Default	0	0	0	0	0	0	inactive	

Card 5 is optional. If this card is defined, then Cards 3 and 4 above must be included. Blank cards may be inserted.

Card 5            1            2            3            4            5            6            7            8

Variable	ISYM	NSEROD	RWGAPS	RWGDT H	RWKSF	ICOV	SWRADF	ITHOFF
Type	I	I	I	F	F	I	F	I
Default	0	0	0	0.	1.0	0	0.	0

Card 6 is optional. If this card is defined, then Cards 3 to 5 above must be included. Blank cards may be inserted.

Card 6            1            2            3            4            5            6            7            8

Variable	SHLEDG	PSTIFF	ITHCNT	TDCNOF	FTALL		SHLTRW	
Type	I	I	I	I	I		F	
Default	0	0	0	0	0		0.	

## VARIABLE

## DESCRIPTION

SLSFAC

Scale factor for sliding interface penalties, SLSFAC:  
EQ.0: default = .1.

---

<u>VARIABLE</u>	<u>DESCRIPTION</u>
RWPNAL	<p>Scale factor for rigid wall penalties, which treat nodal points interacting with rigid walls, RWPNAL. The penalties are set so that an absolute value of unity should be optimal; however, this penalty value may be very problem dependent. If rigid/deformable materials switching is used, this option should be used if the switched materials are interacting with rigid walls.</p> <p>LT.0.0: all nodes are treated by the penalty method. This is required for implicit calculations. Since seven (7) variables are stored for each slave node, only the nodes that may interact with the wall should be included in the node list.</p> <p>EQ.0.0: the constraint method is used and nodal points which belong to rigid bodies are not considered.</p> <p>GT.0.0: rigid bodies nodes are treated by the penalty method and all other nodes are treated by the constraint method.</p>
ISLCHK	<p>Initial penetration check in contact surfaces with indication of initial penetration in output files (see remarks below):</p> <p>EQ.0: the default is set to 1, EQ.1: no checking, EQ.2: full check of initial penetration is performed.</p>
SHLTHK	<p>Shell thickness considered in type surface to surface and node to surface type contact options, where options 1 and 2 below activate the new contact algorithms. The thickness offsets are always included in single surface, constraint method, and automatic surface to surface and node to surface contact types (See remarks below.):</p> <p>EQ.0: thickness is not considered, EQ.1: thickness is considered but rigid bodies are excluded, EQ.2: thickness is considered including rigid bodies.</p>
PENOPT	<p>Penalty stiffness value option. For default calculation of the penalty value please refer to the LS-DYNA Theory Manual.</p> <p>EQ.0: the default is set to 1, EQ.1: minimum of master segment and slave node (default for most contact types), EQ.2: use master segment stiffness (old way), EQ.3: use slave node value, EQ.4: use slave node value, area or mass weighted, EQ.5: same as 4 but inversely proportional to the shell thickness. This may require special scaling and is not generally recommended. Options 4 and 5 can be used for metalforming calculations.</p>

<b>VARIABLE</b>	<b>DESCRIPTION</b>
THKCHG	Shell thickness changes considered in single surface contact: EQ.0: no consideration (default), EQ.1: shell thickness changes are included.
ORIEN	Optional automatic reorientation of contact interface segments during initialization: EQ.0: default is set to 1. EQ.1: active for automated (part) input only. Contact surfaces are given by *PART definitions. EQ.2: active for manual (segment) and automated (part) input. EQ.3: inactive for non-forming contact. EQ.4: inactive for forming contact.
ENMASS	Treatment of the mass of eroded nodes in contact. This option affects all contact types where nodes are removed after surrounding elements fail. Generally, the removal of eroded nodes makes the calculation more stable; however, in problems where erosion is important the reduction of mass will lead to incorrect results. ENMASS is not supported when SOFT=2 on optional card A. EQ.0: eroding nodes are removed from the calculation. EQ.1: eroding nodes of solid elements are retained and continue to be active in contact. EQ.2: the eroding nodes of solid and shell elements are retained and continue to be active in contact.
USRSTR	Storage per contact interface for user supplied interface control subroutine, see Appendix F. If zero, no input data is read and no interface storage is permitted in the user subroutine. This storage should be large enough to accommodate input parameters and any history data. This input data is available in the user supplied subroutine.
USRFRC	Storage per contact interface for user supplied interface friction subroutine, see Appendix G. If zero, no input data is read and no interface storage is permitted in the user subroutine. This storage should be large enough to accommodate input parameters and any history data. This input data is available in the user supplied subroutine.
NSBCS	Number of cycles between contact searching using three dimensional bucket searches. Defaults recommended.
INTERM	Flag for intermittent searching in old surface-to-surface contact using the interval specified as NSBCS above: EQ.0: off, EQ.1: on.



---

<b>VARIABLE</b>	<b>DESCRIPTION</b>
XPENE	Contact surface maximum penetration check multiplier. If the small penetration checking option, PENCHK, on the contact surface control card is active, then nodes whose penetration then exceeds the product of XPENE and the element thickness are set free, see *CONTACT_OPTION_...: EQ.0: default is set to 4.0.
SSTHK	Flag for using actual shell thickness in single surface contact logic-types 4, 13, 15 and 26. See remarks 1 and 2 below. EQ.0: Actual shell thickness is not used in the contacts. (default), EQ.1: Actual shell thickness is used in the contacts. (sometimes recommended for metal forming calculations).
ECDT	Time step size override for eroding contact: EQ.0: contact time size may control Dt. EQ.1: contact is not considered in Dt determination.
TIEDPRJ	Bypass projection of slave nodes to master surface in types: *CONTACT_TIED_NODES_TO_SURFACE, *CONTACT_TIED_SHELL_EDGE_TO_SURFACE, and *CONTACT_TIED_SURFACE_TO_SURFACE tied interface options: EQ.0: eliminate gaps by projection nodes, EQ.1: bypass projection. Gaps create rotational constraints which can substantially affect results.
SFRIC	Default static coefficient of friction (see *PART_CONTACT)
DFRIC	Default dynamic coefficient of friction (see *PART_CONTACT)
EDC	Default exponential decay coefficient (see *PART_CONTACT)
VFC	Default viscous friction coefficient (see *PART_CONTACT)
TH	Default contact thickness (see *PART_CONTACT)
TH_SF	Default thickness scale factor (see *PART_CONTACT)
PEN_SF	Default local penalty scale factor (see *PART_CONTACT)

<b>VARIABLE</b>	<b>DESCRIPTION</b>
IGNORE	<p>Ignore initial penetrations in the *CONTACT_AUTOMATIC options. In the SMP contact this flag is not implement for the AUTOMATIC_GENERAL option. “Initial” in this context refers to the first timestep that a penetration is encountered. This option can also be specified for each interface on the third optional card under the keyword, *CONTACT. The value defined here will be the default.</p> <p>EQ.0: move nodes to eliminate initial penetrations in the model definition.</p> <p>EQ.1: allow initial penetrations to exist by tracking the initial penetrations.</p> <p>EQ.2: allow initial penetrations to exist by tracking the initial penetrations. However, penetration warning messages are printed with the original coordinates and the recommended coordinates of each slave node given.</p>
FRCENG	<p>Flag to activate the calculation of frictional sliding energy:</p> <p>EQ.0: do not calculate,</p> <p>EQ.1: calculate frictional energy in contact and store as “Surface Energy Density” in the binary INTFOR file. Convert mechanical frictional energy to heat when doing a coupled thermal-mechanical problem. When PKP_SEN=1 on the keyword card *DATABASE_EXTENT_BINARY, it is possible to identify the energies generated on the upper and lower shell surfaces, which is important in metal forming applications. This data is mapped after each H-adaptive remeshing.</p>
SKIPRWG	<p>Flag not to display stationary rigid wall by default.</p> <p>EQ.0: generate 4 extra nodes and 1 shell element to visualize stationary planar rigid wall.</p> <p>EQ.1: do not generate stationary rigid wall.</p>
OUTSEG	<p>Flag to output each beam spot weld slave node and its master segment for contact type: *CONTACT_SPOTWELD into the D3HSP file.</p> <p>EQ.0: no, do not write out this information.</p> <p>EQ.1: yes, write out this information.</p>
SPOTSTP	<p>If a spot weld node or face, which is related to a *MAT_SPOTWELD beam or solid element, respectively, cannot be found on the master surface, should an error termination occur?</p> <p>EQ.0: no, continue calculation,</p> <p>EQ.1: yes, print error message and terminate,</p> <p>EQ.2: no, delete unconstrained weld and continue calculation.</p>

<b>VARIABLE</b>	<b>DESCRIPTION</b>
SPOTDEL	<p>If the nodes of a spot weld beam or solid element are attached to a shell element that fails and are deleted, then the attached spot weld element is deleted if this flag is on. There is a small cost penalty related to this option on non-vector processors. On vector processors, however, this option can significantly slow down the calculation if many weld elements fail since the vector lengths are reduced.</p> <p>EQ.0: no, do not delete the spot weld beam or solid element, EQ.1: yes, delete the weld elements when the attached shells on one side of the element fail.</p>
SPOTHIN	<p>Optional thickness scale factor. If active, define a factor greater than zero, but less than one. Premature failure of spot welds can occur due to contact of the spot welded parts in the vicinity of the spot weld. This contact creates tensile forces in the spot weld. Although this seems physical, the compressive forces generated in the contact are large enough to fail the weld in tension before failure is observed in experimental test. With this option, the thickness of the parts in the vicinity of the weld are automatically scaled, the contact forces do not develop, and the problem is avoided. We recommend setting the IGNORE option to 1 or 2 if SPOTHIN is active. This option applies only to the AUTOMATIC_SINGLE_SURFACE option.</p>
ISYM	<p>Symmetry plane option default for automatic segment generation when contact is defined by part ID's:</p> <p>EQ.0: off, EQ.1: do not include faces with normal boundary constraints (e.g., segments of brick elements on a symmetry plane).</p> <p>This option is important to retain the correct boundary conditions in the model with symmetry.</p>
NSEROD	<p>Flag to use one-way node to surface erosion</p> <p>EQ.0: use two-way algorithm EQ.1: use one-way algorithm</p>
RWGAPS	<p>Flag to add rigid wall gap stiffness, see parameter RWGDTH below.</p> <p>EQ.1: add gap stiffness EQ.2: do not add gap stiffness</p>
RWGDTH	<p>Death time for gap stiffness. After this time the gap stiffness is no longer added.</p>
RWKSF	<p>Rigid wall penalty scale factor for contact with deformable parts during implicit calculations. This value is independent of SLSFAC and RWPNAL. If RWKSF is also specified in *RIGIDWALL_PLANAR, the stiffness is scaled by the product of the two values.</p>

<b>VARIABLE</b>	<b>DESCRIPTION</b>
ICOV	Invokes the covariant formulation of Konyukhov and Schweizerhof in the FORMING contact option. This option is available in the third revision of version 971, but is not recommended since it is still being implemented. EQ.0: standard formulation (default) EQ.1: covariant contact formulation.
SWRADF	Spot weld radius scale factor for neighbor segment thinning EQ.0: neighbor segments not thinned (default) GT.0: The radius of beam spot welds are scaled by SWRADF when searching for close neighbor segments to thin.
ITHOFF	Flag for offsetting thermal contact surfaces for thick thermal shells EQ.0: No offset, if thickness is not included in the contact the heat will be transferred between the mid-surfaces of the corresponding contact segments (shells). EQ.1: Offsets are applied so that contact heat transfer is always between the outer surfaces of the contact segments (shells).
SHLEDG	Flag for assuming edge shape for shells when measuring penetration. This is available for segment based contact (see SOFT on *CONTACT) EQ.0: Shell edges are assumed round (default), EQ.1: Shell edges are assumed square and are flush with the nodes
PSTIFF	Flag to choose the method for calculating the penalty stiffness. This is available for segment based contact (see SOFT on *CONTACT) EQ.0: Based on material density and segment dimensions (default), EQ.1: Based on nodal masses.
ITHCNT	Thermal contact heat transfer methodology LT.0: conduction evenly distributed (pre R4) EQ.0: default set to 1 EQ.1: conduction weighted by shape functions, reduced intergration EQ.2: conduction weighted by shape functions, full integration
TDCNOF	Tied constraint offset contact update option. EQ.0: Update velocities and displacements from accelerations EQ.1: Update velocities and acclerations from displacements. This option is recommended only when there are large angle changes where the default does not maintain a constant offset to a small tolerance. This latter option is not as stable as the default and may require additional damping for stability. See *CONTROL_BULK_VISCOSITY and *DAMPING_PART_STIFFNESS.

---

<u>VARIABLE</u>	<u>DESCRIPTION</u>
FTALL	Option to output contact forces to RCFORC for all 2 surface force transducers when the force transducer surfaces overlap. EQ.0: Output to the first force transducer that matches (default) EQ.1: Output to all force transducers that match.
SHLTRW	Optional shell thickness scale factor for contact with rigid walls. Shell thickness is not considered when SHLTRW=0 (default). SHLTRW=0.5 will result in an offset of half of shell thickness in contact with rigid walls.

**Remarks:**

1. The shell thickness change option must be activated in CONTROL\_SHELL control input (see ISTUPD) and a nonzero flag specified for SHLTHK above before the shell thickness changes can be included in the surface-to-surface contact types. An additional flag must be set, see THKCHG above, if thickness changes are included in the single surface contact algorithms. The contact algorithms that include the shell thickness are relatively recent and are now fully optimized and parallelized. The searching in these algorithms is considerably more extensive and therefore slightly more expensive.
2. In the single surface contacts types SINGLE\_SURFACE, AUTOMATIC\_SINGLE\_SURFACE, AUTOMATIC\_GENERAL, AUTOMATIC\_GENERAL\_INTERIOR and ERODING\_SINGLE\_SURFACE, the default contact thickness is taken as the smaller of two values -- the shell thickness or 40% of the minimum edge length. This may create unexpected difficulties if it is the intent to include thickness effects when the in-plane shell element dimensions are less than the thickness. The default is based on years of experience where it has been observed that sometimes rather large nonphysical thicknesses are specified to achieve high stiffness values. Since the global searching algorithm includes the effects of shell thicknesses, it is possible to slow the searches down considerably by using such nonphysical thickness dimensions.
3. The initial penetration check option is always performed in v. 950 irregardless of the value of ISLCHK. If you do not want to remove initial penetrations then set the contact birth time (see \*CONTACT\_...) so that the contact is not active at time 0.
4. Automatic reorientation requires offsets between the master and slave surface segments. The reorientation is based on segment connectivity and, once all segments are oriented consistently based on connectivity, a check is made to see if the master and slave surfaces face each other based on the right hand rule. If not, all segments in a given surface are reoriented. This procedure works well for non-disjoint surfaces. If the surfaces are disjoint, the AUTOMATIC contact options, which do not require orientation, are recommended. In the FORMING contact options automatic reorientation works for disjoint surfaces.

5. If SPOTHIN is greater than zero and SWRADF is greater than zero, a neighbor segment thinning option is active. The radius of a beam spot weld is scaled by SWRADF, and then a search is made for shell segments that are neighbors of the tied shell segments that are touched by the weld but not tied by it.
6. Segment based contact (see \*SOFT on \*CONTACT) calculates a penalty stiffness based on the solution time step and the masses of the segments in contact. By default, segment masses are calculated using the material density of the element associated with the segment and the volume of the segment. This method does not take into account added mass introduced by lumped masses or mass scaling and can lead to stiffness that is too low. Therefore, a second method (PSTIFF=1) was added which estimates the segment mass using the nodal masses.
7. Two surface force transducers measure the contact force from any contact interfaces that generate force between the slave and master surfaces of the force transducer. When contact is detected, a search is made to see if the contact force should be added to any 2 surface force transducers. By default, when a force transducer match is found, the force is added and the search terminates. When FTALL=1, the search continues to check for other two surface force transducer matches. This option is useful when the slave and master force transducer surfaces overlap. If there is no overlap, the default is recommended.

**\*CONTROL\_COUPLING**

Purpose: Change defaults for MADYMO3D/CAL3D coupling, see Appendix I.

Card 1            1            2            3            4            5            6            7            8

Variable	UNLENG	UNTIME	UNFORC	TIMIDL	FLIPX	FLIPY	FLIPZ	SUBCYL
Type	F	F	F	F	I	I	I	I
Default	1.	1.	1.	0.	0	0	0	1

<u>VARIABLE</u>	<u>DESCRIPTION</u>
UNLENG	Unit conversion factor for length. MADYMO3D/GM-CAL3D lengths are multiplied by UNLENG to obtain LS-DYNA lengths.
UNTIME	Unit conversion factor for time, UNTIME. MADYMO3D/GM-CAL3D time is multiplied by UTIME to obtain LS-DYNA time.
UNFORC	Unit conversion factor for force, UNFORC. MADYMO3D/GM-CAL3D force is multiplied by UNFORC to obtain LS-DYNA force.
TIMIDL	Idle time during which CAL3D or MADYMO is computing and LS-DYNA remains inactive. Important for saving computer time.
FLIPX	Flag for flipping X-coordinate of CAL3D/MADYMO3D relative to the LS-DYNA model: EQ.0: off, EQ.1: on.
FLIPY	Flag for flipping Y-coordinate of CAL3D/MADYMO3D relative to the LS-DYNA model: EQ.0: off, EQ.1: on.
FLIPZ	Flag for flipping Z-coordinate of CAL3D/MADYMO3D relative to the LS-DYNA model: EQ.0: off, EQ.1: on.

<u>VARIABLE</u>	<u>DESCRIPTION</u>
SUBCYL	<p>CAL3D/MADYMO3D subcycling interval (# of cycles):</p> <p>EQ.0: Set to 1,</p> <p>EQ.n: number of LS-DYNA time steps between each CAL3D/MADYMO3D step. Then the position of the contacting rigid bodies is assumed to be constant for n LS-DYNA time steps. This may result in some increase in the spikes in contact, thus this option should be used carefully. As the CAL3D/MADYMO3D programs usually work with a very small number of degrees of freedom, not much gain in efficiency can be achieved.</p>



**\*CONTROL\_CPU**

Purpose: Control cpu time.

Card	1	2	3	4	5	6	7	8
------	---	---	---	---	---	---	---	---

Variable	CPUTIM	IGLST						
Type	F	I						

<u>VARIABLE</u>	<u>DESCRIPTION</u>
CPUTIM	Seconds of cpu time: EQ.0.0: no cpu time limit set GT.0.0: time limit for cumulative cpu of the entire simulation, including all restarts. LT.0.0: absolute value is the cpu time limit in seconds for the first run and for each subsequent restart.
IGLST	Flag for outputting cpu and elapsed times in glstat file EQ.0: no EQ.1: yes

**Remarks:**

The cpu limit is not checked until after the initialization stage of the calculation. Upon reaching the cpu limit, the code will output a restart dump file and terminate. The CPU limit can also be specified on the LS-DYNA execution line via "c=". If a value is specified on both the execution line and in the input deck, the minimum value will be used.

# \*CONTROL

\*CONTROL\_CPM

## \*CONTROL\_CPM

Purpose: Global control parameters for CPM (Corpuscular Particle Method).

Card 1            1            2            3            4            5            6            7            8

Variable	CPMOUT							
Type	I							
Default	11							

### VARIABLE

### DESCRIPTION

CPMOUT

Control CPM output database to d3plot  
EQ.11: full CPM database in version 3 format (default)  
EQ.21: full CPM database in version 4 format  
EQ.22: CPM coordinates only in version 4 format  
EQ.23: CPM summary only in version 4 format

### Remarks:

“Version 3” is an older format than “version 4”. Version 4 stores data more efficiently than version 3 and has options for what data is stored, but may not be readable by old LS-PrePost executables.

**\*CONTROL\_DISCRETE\_ELEMENT**

Purpose: To define global control parameters for discrete element sphere.

Card 1            1            2            3            4            5            6            7            8

Variable	NDAMP	TDAMP	FricS	FricD				
Type	F	F	F	F				
Default	0	0	0	0				

<b>VARIABLE</b>	<b>DESCRIPTION</b>
-----------------	--------------------

- |       |   |
|-------|---|
| NDAMP | Normal damping coefficient  |
| TDAMP | Tangential damping coefficient  |
| FricS | Static friction coefficient<br>EQ.0: 3 DOF<br>NE.0: 6 DOF (consider rotational DOF) |
| FricD | Rolling friction coefficient  |

**\*CONTROL\_DYNAMIC\_RELAXATION**

Purpose: Initialize stresses and deformation in a model to simulate a preload. Examples of preload include load due to gravity, load due to a constant angular velocity, and load due to torquing of a bolt. After the preloaded state is achieved by one of three methods described below, the time resets to zero and the normal phase of the solution automatically begins from the preloaded state.

IDRFLG controls the manner in which the preloaded state is computed. If IDRFLG is 1 or -1, a transient 'dynamic relaxation' analysis is invoked in which an explicit analysis, damped by means of scaling nodal velocities by the factor DRFCTR each time step, is performed. When the ratio of current distortional kinetic energy to peak distortional kinetic energy falls below the convergence tolerance (DRTOL) or when the time reaches DRTERM, the dynamic relaxation analysis stops and the current state becomes the initial state of the subsequent normal analysis. Distortional kinetic energy is total kinetic energy less the kinetic energy due to rigid body motion. A history of the distortional kinetic energy computed during the dynamic relaxation phase is automatically written to a file called "relax". This file can be read as an "ASCII" file by LS-PrePost and its data plotted. To create a binary output database having the same format as a d3plot database but which pertains to the dynamic relaxation analysis, use \*DATABASE\_BINARY\_D3DRLF. The output interval is given by this command as an integer representing the number of convergence checks between output states. The frequency of the convergence checks is controlled by the parameter NRCYCK. Dynamic relaxation will be invoked if SIDR is set to 1 or 2 in any of the \*DEFINE\_CURVE commands, even if there is no \*CONTROL\_DYNAMIC\_RELAXATION command. Curves so tagged are applicable to the preload analysis phase. Curves with SIDR set to 0 or 2 are applicable to the normal phase of the solution. At the conclusion of the dynamic relaxation phase and before the start of the normal solution phase, a binary dump file (d3dump01) and a 'prescribed geometry' file (drdisp.sif) are written by LS-DYNA. Either of these files can be used in a subsequent analysis to quickly initialize to the preloaded state without having to repeat the dynamic relaxation run. The binary dump file is utilized via a restart analysis (see the \*RESTART section of the LS-DYNA Users Manual). The drdisp.sif file is utilized by setting IDRFLG=2 as described below and discussed in Remark 1.

If IDRFLG is set to 2, the preloaded state is quickly reached by linearly ramping nodal displacements, rotations, and temperatures to prescribed values over 100 time steps. See Remark 1.

If IDRFLG is set to 5, an implicit analysis is performed to obtain the preloaded state and in this case, the preload analysis completes when 'time' is equal to DRTERM. The implicit step size is specified with a \*CONTROL\_IMPLICIT\_GENERAL command. The implicit analysis is, by default, static but can be made transient via the \*CONTROL\_IMPLICIT\_DYNAMICS command (see Remark 3).

Card            1            2            3            4            5            6            7            8

Variable	NRCYCK	DRTOL	DRFCTR	DRTERM	TSSFDR	IRELAL	EDTTL	IDRFLG
Type	I	F	F	F	F	I	F	I
Default	250	0.001	0.995	infinity	TSSFAC	0	0.04	0
Remarks				3				1, 2, 3

**Define the following card if and only if IDRFLG=3.**

                  1            2            3            4            5            6            7            8

Variable	DRPSET							
Type	I							
Default	0							
Remarks	4							

<u>VARIABLE</u>	<u>DESCRIPTION</u>
NRCYCK	Number of iterations between convergence checks, for dynamic relaxation option (default = 250).
DRTOL	Convergence tolerance for dynamic relaxation option (default = 0.001).
DRFCTR	Dynamic relaxation factor (default = .995).
DRTERM	Optional termination time for dynamic relaxation. Termination occurs at this time or when convergence is attained (default = infinity).
TSSFDR	Scale factor for computed time step during dynamic relaxation. If zero, the value is set to TSSFAC defined on *CONTROL_TIMESTEP. After converging, the scale factor is reset to TSSFAC.

<u>VARIABLE</u>	<u>DESCRIPTION</u>
IRELAL	Automatic control for dynamic relaxation option based on algorithm of Papadrakakis [1981]: EQ.0: not active, EQ.1: active.
EDTTL	Convergence tolerance on automatic control of dynamic relaxation.
IDRFLG	Dynamic relaxation flag for stress initialization: EQ.-999: dynamic relaxation not activated even if specified on a load curve, see *DEFINE_CURVE, EQ.-1: dynamic relaxation is activated and time history output is produced during dynamic relaxation, see Remark 2. EQ.0: not active, EQ.1: dynamic relaxation is activated, EQ.2 initialization to a prescribed geometry, see Remark 1, EQ.3 dynamic relaxation is activated as with IDRFLG=1, but with a part set ID for convergence checking, EQ.5: initialize implicitly, see Remark 3.
DRPSET	Part set ID for convergence checking (for IDRFLG=3 only)

**Remarks:**

1. When IDRFLG=2, an ASCII file specified by "m=" on the LS-DYNA execution line is read which describes the initialized state. The ASCII file contains each node ID with prescribed values of nodal displacement (x, y, z), nodal rotation (x, y, z) and nodal temperature in (I8, 7E15.0) format.
2. If IDRFLG is set to -1 the dynamic relaxation proceeds as normal but time history data is written to the D3THDT file in addition to the normal data being written to the D3DRLF file. At the end of dynamic relaxation, the problem time is reset to zero. However, information is written to the D3THDT file with an increment to the time value. The time increment used is reported at the end of dynamic relaxation.
3. When IDRFLG=5, LS-DYNA performs an implicit analysis for the preload phase of the simulation. Parameters for controlling the implicit preload solution are defined using appropriate \*CONTROL\_IMPLICIT keywords to specify solver type, implicit time step, etc. When using this option, one must specify DRTERM to indicate the termination "time" of the implicit preload analysis. When DRTERM is reached, the implicit preload phase terminates and LS-DYNA begins the next phase of the analysis according to IMFLAG in \*CONTROL\_IMPLICIT\_GENERAL. For example, if it is desired to run an implicit preload phase and switch to the explicit solver for the subsequent transient phase, IDRFLG should be set to 5 and IMFLAG should be set to 0.

4. When IDRFLG=3, a part set ID is used to check for convergence. For example, if only the tires are being inflated on a vehicle, it may be sufficient in some cases to look at convergence based on the part ID's in the tire and possibly the suspension system.

**\*CONTROL\_EFG**

Purpose: Define controls for the mesh-free computation.

Card 1            1            2            3            4            5            6            7            8

Variable	ISPLINE	IDILA	ININT					
Type	I	I	I					
Default	0	0	12					
Remarks			1					

Card 2            1            2            3            4            5            6            7            8

Variable	IMLM	ETOL	IDEB	HSORT	SSORT			
Type	I	F	I	I	I			
Default	0	1.eE-4	0	0	0			

**VARIABLE****DESCRIPTION**

ISPLINE

Optional choice for the mesh-free kernal functions:

EQ.0: Cubic spline function (default)

EQ.1: Quadratic spline function

EQ.2: Cubic spline function with circular disk.

IDILA

Optional choice for the normalized dilation parameter:

EQ.0: Maximum distance based on the background element.

EQ.1: Maximum distance based on surrounding nodes

ININT

This is the factor needed for the estimation of maximum workspace (MWSPAC) that can be used during the initialization phase.

IMLM

Optional choice for the matrix operation, linear solving and memory usage:

EQ.1: Original BCSLIB-EXT solvers.



<u>VARIABLE</u>	<u>DESCRIPTION</u>
	EQ.2: EFGPACK.
ETOL	Error tolerance in the IMLM. When IMLM=2 is used, ININT in card one becomes redundant. IMLM = 2 is recommended.
IDEB	Output internal debug message
HSORT	Not used
SSORT	Automatic sorting of background triangular shell elements to FEM #2 when EFG shell type 41 is used EQ. 0: no sorting EQ. 1: full sorting

**Remarks:**

1. The mesh-free computation requires calls to use BCSLIB-EXT solvers during the initialization phase. The maximum workspace (MWSPAC) that can be used during the call is calculated according to:

$$MWSPAC = ININT^{**3} * NUMNEFG$$

where NUMNEFG is the total number of mesh-free nodes. The ININT default value is 12. This value implicitly tells you how many nodes are within the domain of influence per each node in one direction. Increasing this number when the larger normalized dilation parameters are used.

2. When ISPLINE=2 is used, the input of the normalized dilation parameters (DX, DY, DZ) for the kernel function in \*SECTION\_SOILD\_EFG and SECTIOL\_SHELL\_EFG only requires DX value.
3. EFGPACK was added to automatically compute the required maximum workspace in the initialization phase and to improve efficiency in the matrix operation, linear solving and memory usage. The original BCSLIB-EXT solver requires an explicit workspace (ININT) for the initialization.

# \*CONTROL

# \*CONTROL\_ENERGY

## \*CONTROL\_ENERGY

Purpose: Provide controls for energy dissipation options.

Card            1            2            3            4            5            6            7            8

Variable	HGEN	RWEN	SLNTEN	RYLEN				
Type	I	I	I	I				
Default	1	2	1	1				

### VARIABLE

### DESCRIPTION

HGEN	Hourglass energy calculation option. This option requires significant additional storage and increases cost by ten percent: EQ.1: hourglass energy is not computed (default), EQ.2: hourglass energy is computed and included in the energy balance. The hourglass energies are reported in the ASCII files GLSTAT and MATSUM, see *DATABASE_OPTION.
RWEN	Rigidwall energy (a.k.a. stonewall energy) dissipation option: EQ.1: energy dissipation is not computed, EQ.2: energy dissipation is computed and included in the energy balance (default). The rigidwall energy dissipation is reported in the ASCII file GLSTAT, see *DATABASE_OPTION.
SLNTEN	Sliding interface energy dissipation option (This parameter is always set to 2 if contact is active. The option SLNTEN=1 is not available.): EQ.1: energy dissipation is not computed, EQ.2: energy dissipation is computed and included in the energy balance. The sliding interface energy is reported in ASCII files GLSTAT and SLEOUT, see *DATABASE_OPTION.
RYLEN	Rayleigh energy dissipation option (damping energy dissipation): EQ.1: energy dissipation is not computed (default), EQ.2: energy dissipation is computed and included in the energy balance. The damping energy is reported in ASCII file GLSTAT, see *DATABASE_OPTION.

**\*CONTROL\_EXPLOSIVE\_SHADOW**

Purpose: Compute detonation times in explosive elements for which there is no direct line of sight. If this control card is missing, the lighting time for an explosive element is computed using the distance from the center of the element to the nearest detonation point,  $L_d$ ; the detonation velocity,  $D$ ; and the lighting time for the detonator,  $t_d$ :

$$t_L = t_d + \frac{L_d}{D}$$

The detonation velocity for this option is taken from the element whose lighting time is computed and does not account for the possibilities that the detonation wave may travel through other explosives with different detonation velocities or that the line of sight may pass outside of the explosive material.

If this control card is present, the lighting time is based on the shortest distance through the explosive material. If inert obstacles exist within the explosive material, the lighting time will account for the extra time required for the detonation wave to travel around the obstacles. The lighting times also automatically accounts for variations in the detonation velocity if different explosives are used. No additional input is required for this control option. This option works for two and three-dimensional solid elements. Also, see \*INITIAL\_DETONATION and \*MAT\_HIGH\_EXPLOSIVE.

**\*CONTROL\_FORMING\_AUTO\_NET**

Purpose: This keyword facilitates springback simulation of a formed panel on resting nets of a checking fixture. With this keyword, nets are automatically generated according to specified dimensions and positions.

Card 1            1            2            3            4            5            6            7            8

Variable	IDNET	ITYPE	IDV	IDP	X	Y	Z	
Type	I		I	I	F	F	F	
Default	none		0	0	0.0	0.0	0.0	

Card 2            1            2            3            4            5            6            7            8

Variable	SX	SY	OFFSET					
Type	F	F	F					
Default	0.0	0.0	0.0					

**Cards 3,4,5,6... repeat Card 1 and 2, as many times as needed to define multiple nets. The next "\*" card terminates the input.**

<u>VARIABLE</u>	<u>DESCRIPTION</u>
IDNET	ID of the net; must be unique.
ITYPE	Not used at this time.
IDV	Vector ID indicating the direction of the net to be generated. See *DEFINE_VECTOR for details. If not defined, the net will be generated along the global Z-axis.
IDP	Part ID of the panel undergoing springback simulation.
X	X-coordinate of a reference point for the net to be generated.
Y	Y-coordinate of a reference point for the net to be generated.

VARIABLE	DESCRIPTION
Z	Z-coordinate of a reference point for the net to be generated.
SX	Length of the net along X-axis.
SY	Length of the net along Y-axis.
OFFSET	The net will be generated at this offset distance away from the reference point. GT.0: the net will be on the global +Z side, or on the vector head side if IDV is defined. LT.0: the net will be on the global -Z side, or on the vector tail side if IDV is defined.

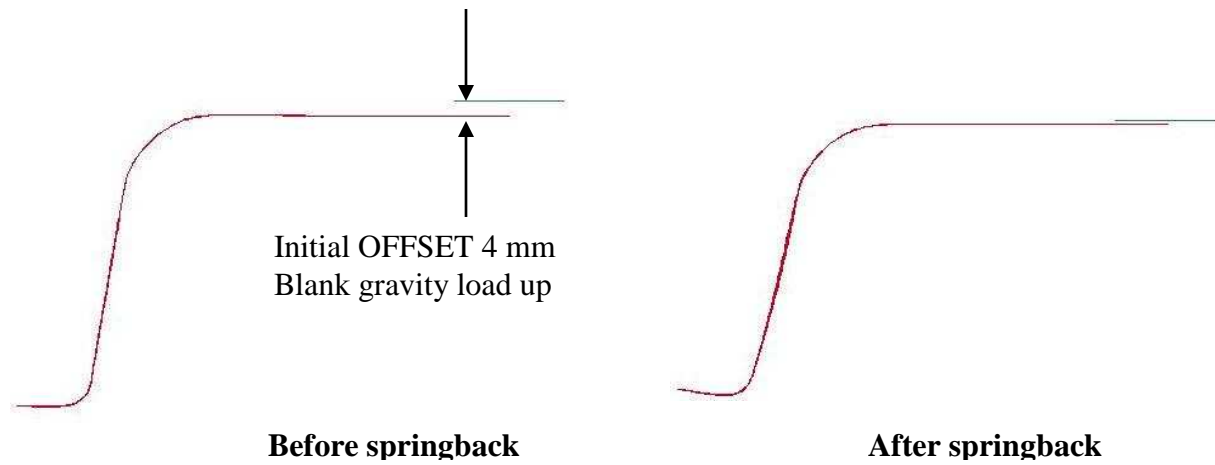
**Remarks:**

1. IDNET is not Part ID of the net to be created. For each X, Y, Z position one net of different part ID will be generated. Part IDs of the generated nets will follow the last part ID in the model and increase in ascending order and is automatically generated. Other properties such as section, material properties and contact interfaces are also established between the panel and nets within the code. Contact type \*CONTACT\_FORMING\_ONE\_WAY\_SURFACE\_TO\_SURFACE is used. Currently, the default type of the net is rectangular in shape.
2. Multiple nets can be generated using one such keyword. In a keyword example shown below, nets ID 1 through 4 are to be generated on the tail side of the vector ID 89, at 4mm away from each respective reference point defined by X, Y and Z coordinates. This example input can be included in a usual springback simulation input deck (without the SPC constraints anywhere) to complete the input file to simulate the panel springback on nets. Gravity load needs to be included.

```

*CONTROL_FORMING_AUTO_NET
$-----1-----2-----3-----4-----5-----6-----7-----8
$  IDNET  ITYPE  IDV  IDP  X  Y  Z
$    1      89    5  2209.82 -33.6332 1782.48
$  SX  SY  OFFSET
$ 15.0 15.0 -4.0
$  IDNET  ITYPE  IDV  IDP  X  Y  Z
$    2      89    5  3060.23 -33.6335 1782.48
$  SX  SY  OFFSET
$ 15.0 15.0 -4.0
$  IDNET  ITYPE  IDV  IDP  X  Y  Z
$    3      89    5  3061.21 31.4167 1784.87
$  SX  SY  OFFSET
$ 15.0 15.0 -4.0
$  IDNET  ITYPE  IDV  IDP  X  Y  Z
$    4      89    5  2208.84 31.4114 1784.87
$  SX  SY  OFFSET
$ 15.0 15.0 -4.0
    
```





4. This feature is now available in Implicit Static in LS-DYNA R5 Revision 62781 or later releases.

# \*CONTROL

# \*CONTROL\_FORMING\_AUTOPOSITION\_PARAMETER

## \*CONTROL\_FORMING\_AUTOPOSITION\_PARAMETER\_{OPTION}

Available options include:

<BLANK>

SET

Purpose: The keyword is developed to calculate the minimum required separation distances among forming tools for initial tool and blank positioning in metal forming simulation.

### Cards 1,2,3,4, ... (the next "\*" card terminates the input)

Card 1            1            2            3            4            5            6            7            8

Variable	PID	CID	DIR	MPID	POSITION	PREMOVE	THICK	PARORDER
Type	I	I	I	I	I	F	F	I/A
Default	none	0	none	none	0	0.0	0.0	None

### VARIABLE

### DESCRIPTION

PID	Part ID. This part will be moved based on the following controlling parameters. When option _SET is activated, PID becomes part set ID, defined by *SET_PART_LIST. It is useful in defining tailor-welded blanks, where two pieces of the blanks must move simultaneously.
CID	Coordinate ID (Default is global coordinate system).
DIR	Direction in which the part will be moved: EQ. 1: x direction, EQ. 2: y direction, EQ. 3: z direction.
MPID	Master part ID, whose position is to be referenced by PID for positioning. When option _SET is activated, MPID becomes part set ID, defined by *SET_PART_LIST.



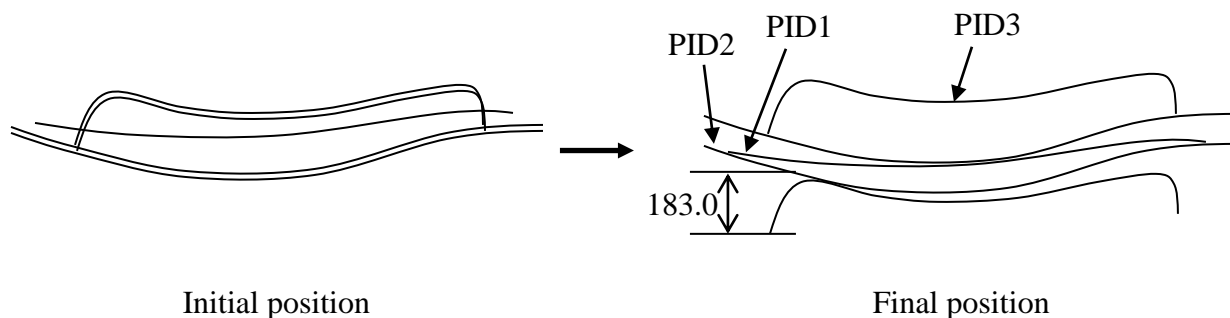
<u>VARIABLE</u>	<u>DESCRIPTION</u>
POSITION	Definition of relative position between PID and MPID: EQ.1: PID is above MPID; EQ.-1: PID is below MPID. Definition of 'above' is determined by the defined coordinate system. IF PID is above MPID, it means PID has a larger z-coordinate. This definition is helpful in line die simulation where local coordinate system may be used.
PREMOVE	PID is moved with a value of PREMOVE before it is positioned.
THICK	Thickness of the PID.
PARORDER	The name of the variable without the ampersand &, as defined in *PARAMETER, or the position or order of the parameter defined in the *PARAMETER list.

**Remarks:**

1. In line-die (multi-stage) simulation, initial positioning of tools and blank is one of the major issues preventing several die processes to be run automatically with one job submission. A previous method to run line die simulation is to use a preprocessor between each process to re-position the tools and blank and re-generate the required input decks. In the new approach, all the tools are placed in home position, with desired final gaps. The keyword \*PARAMETER is used to define and initialize the moving distance of each tool as a variable, which later is defined in this keyword for auto positioning. The required distance between each contact pair is calculated and stored in the variable, and in conjunction with \*PART\_MOVE, all tools can be positioned properly. In addition \*PARAMETER\_EXPRESSION can be used to calculate all time related inputs for the tools from the moving distances and user defined tool moving speeds.
2. All tools must be in their home positions. In addition, inputs pertaining to this keyword is order sensitive. The following order should be followed:  
All model information – include all elements and nodes first;  
Part set definition with \*SET\_PART\_LIST;  
\*PARAMETER;  
This keyword;  
\*PARAMETER\_EXPRESSION;  
\*PART\_MOVE.
3. This keyword can also be used to just position the tools and blank, without forming simulation, and output dynain file which contains the blank and tools. In this case, keywords \*PARAMETER\_EXPRESSION, \*CONTROL\_TERMINATION, and tool kinematic definitions do not need to be defined.

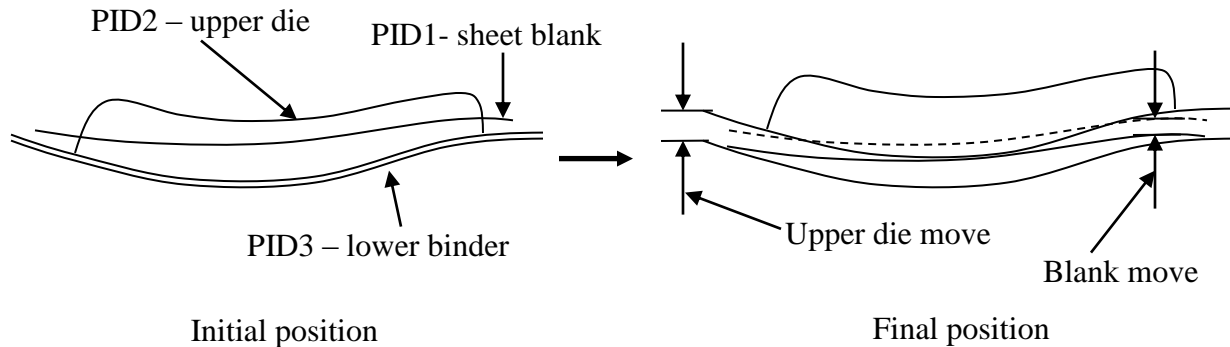
- To calculate the kinematics of the tools, it is suggested to use the ABSOLUTE value of the auto positioned distance by using the ABS function with the \*PARAMETER\_EXPRESSION. This is especially useful when working on flanging simulation with local coordinates and vectors, which could generate negative distances depending on the local coordinate system defined. Flanging steel moving in any direction can be defined by creating a local coordinate system and a vector, with keywords \*DEFINE\_COORDINATE\_SYSTEM. The local coordinate system can be created easily with Coord and Vector menus in page 5 of the LS-PrePost. For the local system, select SYSTEM under Create, and use EPoint and alongZ to define the system based on one straight line.
- Draw beads can be modeled with beam elements, positioned and attached to a tool at home position. Draw beads with beam elements can be moved in the keyword \*PART\_MOVE, and automatically positioned just like any other types of elements.
- REMOVE can be used to position the lower punch a specific distance away from the blank. For example, in an air draw process in the example below, a blank PID 1 is positioned relative to the binder PID 2 first, then an upper die cavity PID 3 is positioned relative to the blank PID 1. Finally a binder PID 2 is positioned with respect to the blank PID 1 and with a pre-determined REMOVE distance of 183.0 mm. The following keywords illustrate the details.

```
$---+---1---+---2---+---3---+---4---+---5---+---6---+---7---+---8
*CONTROL_FORMING_AUTOPOSITION_PARAMETER
$---+---1---+---2---+---3---+---4---+---5---+---6---+---7---+---8
$      PID      CID      DIR      MPID  POSITION  PREMOVE  THICK  PARORDER
$ blankmv
      1          3          2          1          &bthick  blankmv
$ updiemv
      3          3          1          1          updiemv
$ premove of binder up 183.0 so post won't support blank at all. The distance
$ have to be pre-measured by users. It's a part of the process input.
$ bindmv
      2          3          1          -1  183.0          bindmv
$---+---1---+---2---+---3---+---4---+---5---+---6---+---7---+---8
```



- Extra punch support or extra gap between punch and blank can also be achieved by adding (or subtracting) a user defined value to (or, from) the auto positioned distance, using \*PARAMETER\_EXPRESSION and \*PART\_MOVE.

8. A partial input deck and a drawing are shown below to illustrate an example of a binder closing simulation in an air draw in global Z-direction:



```

*INCLUDE
$blank from previous case
case5.dynain
*INCLUDE
closing_tool.k
*INCLUDE
beads_home.k
*SET_PART_LIST
$ blank
1
1
*SET_PART_LIST
$ upper die
2
2
*SET_PART_LIST
$ lower binder
3
3
$---+---1---+---2---+---3---+---4---+---5---+---6---+---7---+---8
*parameter
$$$$$$$$$$$$$$$$$$$$$$$$$$$$$$$$$$$$$$$$ Tool move variables
R blankmv      0.0
R updiemv     0.0
R bindmv      0.0
$$$$$$$$$$$$$$$$$$$$$$$$$$$$$$$$$$$$$$$$ Tool speed and ramp up definition
R tclsup      0.001
R vcls       1000.0
$---+---1---+---2---+---3---+---4---+---5---+---6---+---7---+---8
*CONTROL_FORMING_AUTOPOSITION_PARAMETER_SET
$   PID      CID      DIR      MPID  POSITION  PREMOVE    THICK  PARORDER
$ positioning blank on top of lower binder
   1          3          3          3          1          0.7    blankmv
$ positioning upper die on top of blank
   2          3          1          1          1          0.7    updiemv
$---+---1---+---2---+---3---+---4---+---5---+---6---+---7---+---8
*PARAMETER_EXPRESSION
$   PRMR1    EXPRESSION
R clstime   (abs(updiemv)-vcls*tclsup)/vcls+2.0*tclsup
R endtime   &clstime
$---+---1---+---2---+---3---+---4---+---5---+---6---+---7---+---8

```

# \*CONTROL

# \*CONTROL\_FORMING\_AUTOPOSITION\_PARAMETER

---

```
*PART_MOVE
$  PID          XMOV          YMOV          ZMOV          CID
   1           0.0           0.0           &blankmv
   2           0.0           0.0           &updiemv
$---+---1---+---2---+---3---+---4---+---5---+---6---+---7---+---8
*CONTROL_TERMINATION
&endtime
```

**\*CONTROL\_FORMING\_ONESTEP\_OPTION**

Purpose: This keyword activates a one-step solution, also called ‘inverse method’, which can be applied in initial blank size/material cost estimation, and initialization of plastic strains and blank thickness for crash simulation. The input is a formed or trimmed part (with holes filled) and the output is a corresponding flat blank in an unformed state, along with all the stress/strain information on the formed or trimmed part. This feature utilizes some of the existing implicit static solver to iterate and to arrive at a converged solution.

Available options include:

**<BLANK>**

**AUTO\_CONSTRAINT**

**DRAWBEAD**

**FRICITION**

Option **AUTO\_CONSTRAINT** allows nodal restraints to be applied automatically in implicit calculation to prevent rigid body motion. Option **DRAWBEAD** is used for application of extra draw bead forces, in addition to the AUTOBD below. Option **FRICITION** applies friction along the periphery of the part, based on a user input “binder pressure”.

**Card 1 for no option <BLANK>:**

Card 1            1            2            3            4            5            6            7            8

Variable	OPTION	UNUSED	AUTOBD					
Type	I		F					
Default	none		0.3					

# \*CONTROL

# \*CONTROL\_FORMING\_ONESTEP

## Card 1 for option AUTO\_CONSTRAINT:

Card 1            1            2            3            4            5            6            7            8

Variable	ICON							
Type	I							
Default	none							

## Card 1 for option DRAWBEAD:

Card 1            1            2            3            4            5            6            7            8

Variable	NDSET	LCID	TH	PERCNT				
Type	I	I	F	F				
Default	none	none	0.0	0.0				

## Card 1 for option FRICTION:

Card 1            1            2            3            4            5            6            7            8

Variable	NDSET	BDTON	FRICT					
Type	I	F	F					
Default	none	0.0	0.12					

**Card 2:**

Card 2            1            2            3            4            5            6            7            8

Variable	Blank						
Type	Blank						
Default	Blank						

<u>VARIABLE</u>	<u>DESCRIPTION</u>
OPTION	One-step solution method: EQ.7: Invokes a one-step solution with blank unfolding that accounts for part undercut
UNUSED	Unused – leave blank.
AUTOBD	Apply a constant draw bead lock force fraction of the fully locked bead force along the entire periphery of the blank. The fully locked bead force is automatically calculated based on a material hardening curve input. LT. 0.0: Turns off the “auto-bead” feature. EQ. 0.0: Automatically applies 30% of fully locked force. GT. 0.0: Fraction input will be used to scale the fully locked force.
ICON	Automatic nodal constraining option to eliminate the rigid body motion: EQ. 1: Apply.
NDSET	Node set ID along the periphery of the part, as defined by keyword *SET_NODE_LIST.
LCID	Load curve ID that defines the material hardening curve.
TH	Thickness of the unformed sheet blank.
PERCNT	Draw bead lock force fraction of the fully locked bead force.
BDTON	Binder tonnage used to calculate friction force.
FRICT	Coefficient of friction.

**Remarks:**

1. One-step solution employs the deformation theory as opposed to the incremental theory. It uses the final product geometry to calculate backwards for the initial unformed state. Since the deformation loading is linear, it is strain path-independent and therefore history independent. Binder and addendum geometry are not required, saving a lot of efforts in creating these geometries; stamping die processes are not of concern; there is no need for contact treatment, either, since there are no tools and dies involved.
2. In addition to the usual input for part, material and physical properties, final product mesh in keyword format is needed. Any trimmed-out holes must be filled. The filling can be done in LS-PrePost v3.2, by selecting Mesh/Element/Shell/Shell by Fill\_Holes/Auto Fill.
3. Results are stored in an ASCII file named 'onestepresult'. It is essentially a dynain file storing final forming thickness and plastic strains, which can be plotted within LS-PrePost. Additionally, the final estimated blank size (in its initial, flat state) can be viewed and output through d3plot files, along with intermediate shapes stored for each implicit step. The first state will be the initial estimated blank from LS-PrePost.
4. Multiple parts are allowed to accommodate the filling of holes in a trimmed part.
5. Both shell element types 2 and 16 are supported. Results are output on all integration points based on the variables ELFORM and NIP specified in \*SECTION\_SHELL.
6. Currently, \*MAT\_024, and \*MAT\_037 are supported in the solution. Material hardening curve must be input through the variable LCSS in \*MAT\_024 and HLCID in \*MAT\_037. The variable ETAN in both material models will be supported in a future release. In addition, in \*MAT\_024, strain rate is not accounted for even if the variables C, P are present. Tables in \*MAT\_024 are also supported.
7. Draw beads can be applied along the periphery of the final part in two ways. The first so-called 'Auto Beads' applies a 30% of the fully locked bead force to all nodes along the part boundary automatically, by setting AUTOBD to either 0.0 or 0.3. Optionally, a node set can be defined along the part boundary and a lock force fraction can be applied using the \_DRAWBEAD option. The force fraction is based on the fully locked force, determined by tensile strength and sheet thickness, and is automatically calculated within the solver. In most cases, default lockage of 30% from 'Auto Beads' achieves sufficiently good results.
8. Optionally, friction can be accounted for, by using a new option \_FRICTION. The frictional force is based on an expected binder tonnage applied, and is a percentage of the input force.
9. Nodal restraints used in implicit calculation to prevent rigid body motion are automatically applied using a new option \_AUTO\_CONSTRAINT, by setting ICON to 1.
10. All other implicit cards, such as \*CONTROL\_IMPLICIT\_GENERAL, \_SOLUTION, \_SOLVER, \_AUTO, \_TERMINATION, etc., are used to set the convergence tolerance, termination criterion, etc. It was determined, that the two important variables controlling the solution convergence, DELTAU in \*CONTROL\_IMPLICIT\_TERMINATION, and DCTOL



in \*CONTROL\_IMPLICIT\_SOULTION, can be set to 0.001 and 0.01, respectively, to obtain the most efficient and best results. In addition, four total steps are usually sufficient by setting DTO and ENDTIM accordingly.

11. The following example provides a partial input file with all typical control cards. It will iterate for four steps, with 'Auto Beads' of 30% lock force applied around the part boundary, and with automatic nodal constraints.

```
*CONTROL_TERMINATION
$ ENDTIM
  1.0
*CONTROL_IMPLICIT_GENERAL
$ IMFLAG      DTO
  1          0.25
*CONTROL_FORMING_ONESTEP
$ OPTION              AUTODB
  7
*CONTROL_FORMING_ONESTEP_AUTO_CONSTRAINT
$ ICON
  1
*CONTROL_IMPLICIT_TERMINATION
$ DELTAU
  0.001
*CONTROL_IMPLICIT_SOLUTION
$ NSLOLVR  ILIMIT  MAXREF  DCTOL  ECTOL
  2         11      1200    0.01   1.00
*CONTROL_IMPLICIT_SOLVER
$ LSOLVR
  4
*CONTROL_IMPLICIT_AUTO
$ IAUTO  ITEOPT  ITEWIN  DTMIN  DTMAX
  0      0       0       0.0    0.0
```

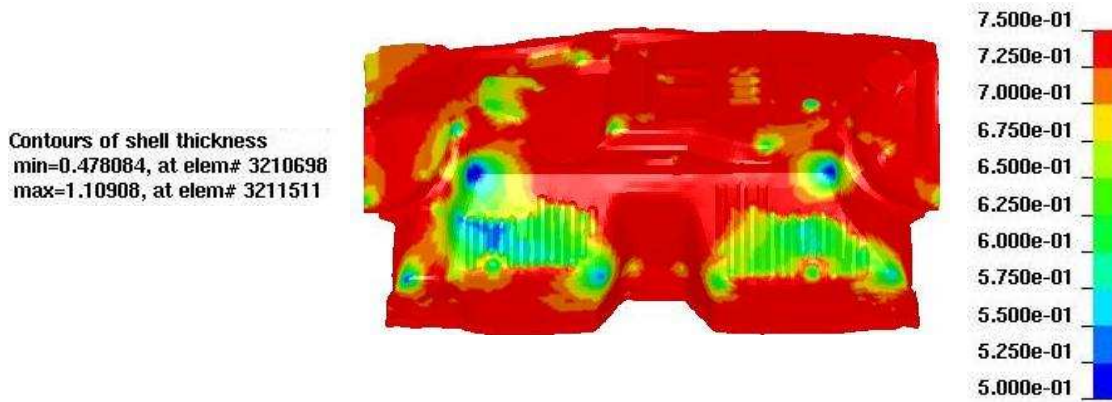
Additional cards below specify extra bead forces of 45% and 30% applied to node set 22, and 23, respectively. Also, the resulting friction forces with friction coefficient of 0.1 and binder tonnage of 10000.0 N are applied on the same node sets.

```
*CONTROL_FORMING_ONESTEP_DRAWBEAD
$ NDSET    LCID    TH    PERCNT
  22       200    1.6    0.45
*CONTROL_FORMING_ONESTEP_DRAWBEAD
  23       200    1.6    0.30
*CONTROL_FORMING_ONESTEP_FRICTION
$ NDSET    BDTON   FRICT
  22      10000.0   0.1
*CONTROL_FORMING_ONESTEP_FRICTION
$ NDSET    BDTON   FRICT
  23      10000.0   0.1
```

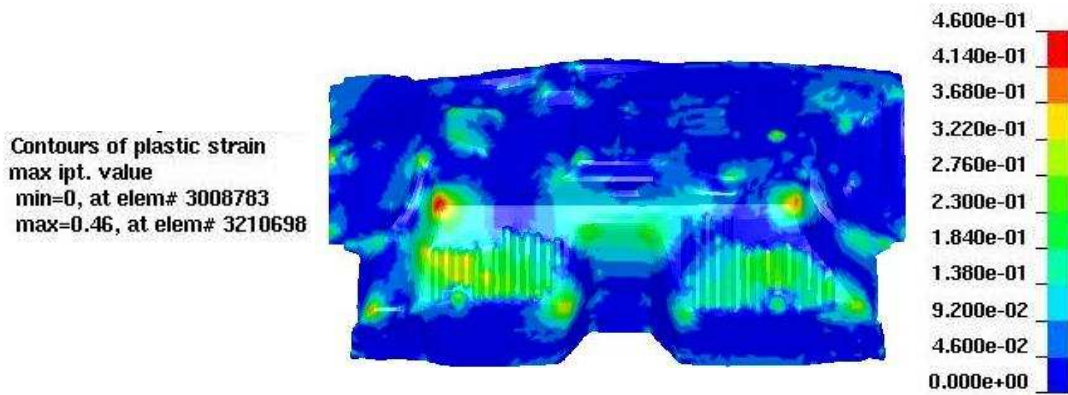
An example of a NCAC Taurus model firewall using the feature is shown below. With average element size of 8 mm across the blank, the trimmed part (with holes filled) consists of 15490 elements. A BH210 material properties with \*MAT\_024 was used. On a 1 CPU Linux machine, it took 4 min. to complete the run with 4 steps total. Thickness, plastic strain, and blank size prediction were reasonable, as shown in the following Figures.



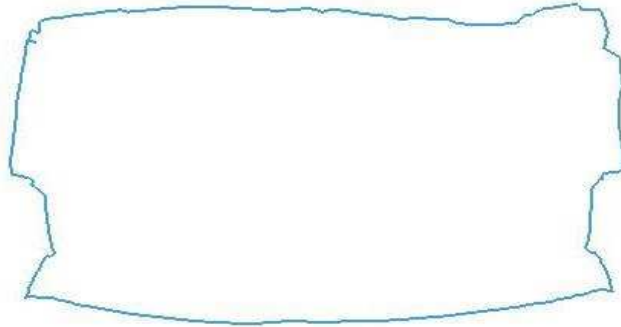
Trimmed-out Holes Filled with LS-PrePost



Sheet Thickness Prediction ( $t_0=0.75\text{mm}$ )



Plastic Strain Prediction



Initial Blank Size Prediction (not to be scaled)

12. Card #2 is a blank card, but must be present.

13. The latest feature is available in R5 Revision 67778 and later releases.

# \*CONTROL

# \*CONTROL\_FORMING\_PARAMETER\_READ

## \*CONTROL\_FORMING\_PARAMETER\_READ

Purpose: This feature allows for reading of a numerical number from an existing file and store in a defined parameter. The parameter can be used and referred in the current simulation. The file to be read may be a result from a previous simulation. The file may also simply contain a list of numbers defined beforehand and to be used for the current simulation.

Card 1            1            2            3            4            5            6            7            8

Variable	FILENAME
Type	C

### Cards 2,3,4, ... (the next "\*" card terminates the input)

Card 2            1            2            3            4            5            6            7            8

Variable	PARNAME	METHOD	LINE #	BEGIN	END			
Type	C	I	I	I	I			
Default	none	0	0	0	0			

<u>VARIABLE</u>	<u>DESCRIPTION</u>
FILENAME	Name of the file to be read.
PARNAME	Parameter name. Maximum character length: 7.
METHOD	Read instruction: EQ. 1: read, follow definition by LINE#, BEGIN and END definition
LINE #	Line number in the file.
BEGIN	Beginning column number in the line number defined above.
END	Ending column number in the line number defined above.

**Remarks:**

1. Keyword input order is sensitive. Recommended order is to define variables in \*PARAMETER first, followed with this keyword, using the defined variables.
2. Multiple variables can be defined with one such keyword, with the file name needed to be defined only once. If there are variables located in multiple files, the keyword needs to be repeated for each file.
3. An example provided below shows that multiple PIDs for individual tools and blank are defined in files "data.k" and "data1.k". In the main input file "sim.dyn" used for LS-DYNA execution, variables (integer) are first initialized for PIDS of all tools and blank with \*PARAMETER. These variables are updated with integers read from files "data.k" and "data1.k" from respective line number and column number through the use of this keyword. In the \*SET\_PART\_LIST definition, these PIDs are used to define the part set.

Below is file "data.k", to be read into "sim.dyn":

```

$$$$$$$$$$$$$$$$$$$$$$$$$$$$$$$$$$$$
$$$ define PIDs
$$$$$$$$$$$$$$$$$$$$$$$$$$$$$$$$$$$$
$---+---1---+---2---+---3---+---4---+---5---+---6---+---7---+---
upper die pid:          3
lower post pid:        2

```

Below is file "data1.k", also to be read into "sim.dyn":

```

$$$$$$$$$$$$$$$$$$$$$$$$$$$$$$$$$$$$
$$$$$$$$$$$$$$$$$$$$$$$$$$$$$$$$$$$$
$$$$$$$$$$$$$$$$$$$$$$$$$$$$$$$$$$$$
$$$ define PIDs
$$$$$$$$$$$$$$$$$$$$$$$$$$$$$$$$$$$$
$---+---1---+---2---+---3---+---4---+---5---+---6---+---7---+---
lower binder pid:      4
blank pid:             1

```

Below is partial input for the main input file "sim.dyn":

```

$---+---1---+---2---+---3---+---4---+---5---+---6---+---7---+---
*INCLUDE
blank.k
*INCLUDE
tool.k
$---+---1---+---2---+---3---+---4---+---5---+---6---+---7---+---
*PARAMETER
Iblankp,0
Iupdiep,0
Ipunchp,0
Ilbindp,0
Rblankmv,0.0
Rpunchmv,0.0
Rupdiemv,0.0
Rbindmv,0.0
Rbthick,1.6

```

```

$---+---1---+---2---+---3---+---4---+---5---+---6---+---7---+---
*CONTROL_FORMING_PARAMETER_READ
data.k
updiep,1,5,30,30
punchp,1,6,30,30
*CONTROL_FORMING_PARAMETER_READ
data1.k
lbindp,1,7,30,30
blankp,1,8,30,30
$---+---1---+---2---+---3---+---4---+---5---+---6---+---7---+---
*SET_PART_LIST
1
&blankp
*SET_PART_LIST
2
&punchp
*SET_PART_LIST
3
&updiep
*SET_PART_LIST
4
&lbindp
$---+---1---+---2---+---3---+---4---+---5---+---6---+---7---+---
*CONTROL_FORMING_AUTOPOSITION_PARAMETER_SET
$#   psid   cid   dir   mpsid  position  premove   thick  parname
      1     0     3     2       1    0.000  &bthick blankmv
      3     0     3     1       1    0.000          updiemv
      4     0     3     1      -1    0.000          bindmv
$---+---1---+---2---+---3---+---4---+---5---+---6---+---7---+---
*PART_MOVE
$pid,xmov,ymov,zmov,cid,ifset
1,0.0,0.0,&blankmv,,1
3,0.0,0.0,&updiemv,,1
4,0.0,0.0,&bindmv,,1

```

4. This feature is available in LS-DYNA R5 Revision 55035 and later releases.

**\*CONTROL\_FORMING\_POSITION**

Purpose: Provides a simple interface for stamping analysis. It is used to position the blank and tooling. When this keyword is used, all the tools must be in the home position, which is the position of the tooling at maximum stroke. From this position each tool will be moved based on this keyword. This keyword is used with the keywords \*CONTROL\_FORMING\_USER and \*CONTROL\_FORMING\_TRAVEL. One \*CONTROL\_FORMING\_POSITION card may be needed for each part.

Card                    1                    2                    3                    4                    5                    6                    7                    8

Variable	PID	PREMOVE	TARGET					
Type	I	F	I					
Default	none	none	I					

<u>VARIABLE</u>	<u>DESCRIPTION</u>
PID	Part ID
PREMOV	The distance to pre-move the tool in the reverse direction of the movement of the tool.
TARGET	Move part (PID) in the reverse direction of this tool movement, and make sure the minimum distance between PID and TARGET is defined by GAP.

**\*CONTROL\_FORMING\_PRE\_BENDING**

Purpose: This keyword allows for a pre-bending of an initially flat sheet metal blank, typically used in controlling its gravity loaded shape.

Card 1            1            2            3            4            5            6            7            8

Variable	PSET	RADIUS	VX	VY	VZ	XC	YC	ZC
Type	I	F	F	F	F	F	F	F
Default	none	none	none	none	none	none	none	none

**VARIABLE****DESCRIPTION**

PSET	Part set ID to be included in the pre-bending.
RADIUS	Radius of the pre-bending. GT.0.0: bending center is on the same side as the element normals LT.0.0: bending center is on the reverse side of the element normals. See figure below for more information.
VX, VY, VZ	Vector components of an axis about which the flat blank will be bent.
XC, YC, ZC	X, Y, Z coordinates of the center of most-bent location. If undefined, center of gravity of the blank will be used as a default.

**Remarks:**

1. In some situation, a flat blank upon gravity loading will result in a “concave” shape in a die, referring to figures below. This mostly happens in cases where there is little or no punch support in the middle of the die cavity. Although the gravity loaded blank shape is correct the end result is undesirable. Buckles may result during the ensuing closing and forming simulation. In reality, a true flat blank rarely exists. Typically, the blank is either manipulated (shaking or bending) by die makers in the tryout stage, or by suction cups in a stamping press, to initially have a convex shape prior to the binder closing and punch forming. This keyword allows this bending to be performed.
2. A partial keyword example is provided below, where blank part set ID &BLKSID defined previously, was to be bent in a radius value of 10000.0mm, with the bending axis of Z, located on the reverse side of the blank positive normal. The bending is off gravity center at

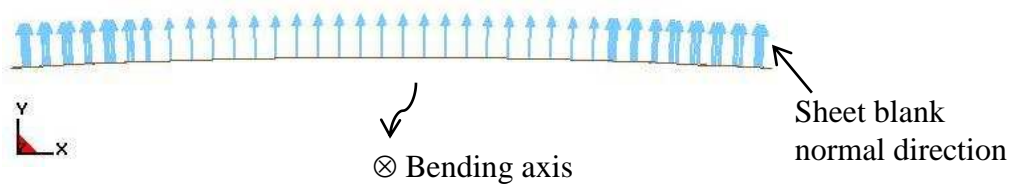


x=234.0, y= 161.0, z=81.6 (to the right along positive X-axis). Only a slight pre-bending on the blank is needed to ensure a convex gravity-loaded shape.

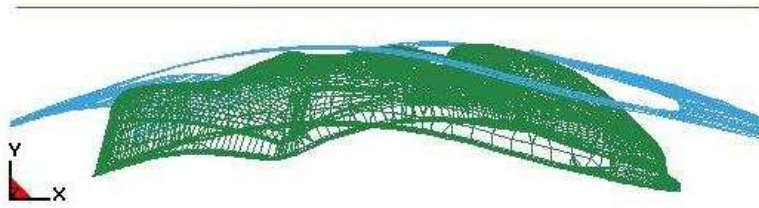
```
*KEYWORD
...
*CONTROL_IMPLICIT_FORMING
1
*CONTROL_FORMING_PRE_BENDING
$      PSET      RADIUS      VX      VY      VZ      XC      YC      ZC
      &BLKSID    -10000.      0.00    0.00    1.0    234.000  161.000  81.60
...
*END
```

In the figures below, gravity-loaded shape without pre-bending and with pre-bending are illustrated.

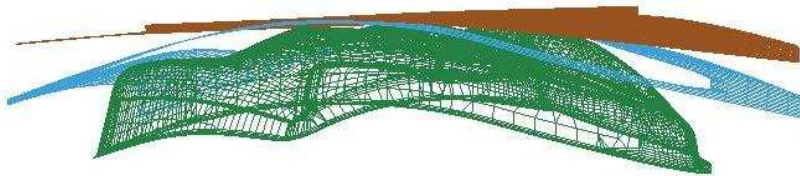
- 3. This feature is available in LS-DYNA R6 Revision 66094 or later releases.



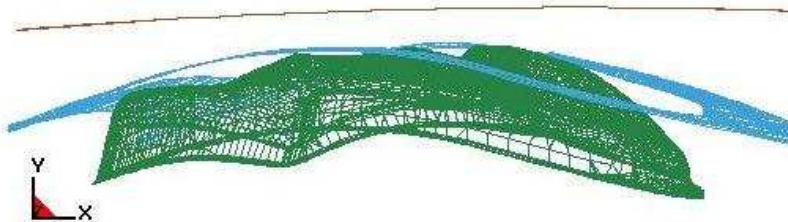
Negative “R” means center of bending is on the opposite side of the positive blank normal



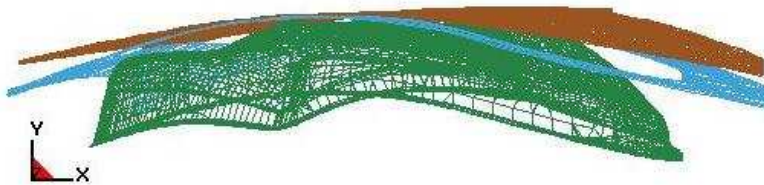
Initial model set up



Gravity loaded blank without using this keyword –  
Blank sags in the die cavity (concave shape)



Pre-bending with R=10000.0mm using this keyword (1<sup>st</sup> state of D3plots)



Gravity loaded shape (last state of D3plots) –  
Convex shape blank achieved and binder closing distance reduced

**Figure 11.3.** Pre-bending of a fender outer (NUMISHEET 2002)

**\*CONTROL\_FORMING\_PROJECTION**

Purpose: To remove initial penetrations between the blank and the tooling by projecting the penetrated blank (slave) nodes along a normal direction to the surface of the blank with the specified gap between the node and the tooling surface.

Card            1            2            3            4            5            6            7            8

Variable	IDPS	IDPM	GAP	NRSST	NRMST			
Type	I	I	F	I	I			
Default								

<u>VARIABLE</u>	<u>DESCRIPTION</u>
IDPS	Part ID for the blank (slave) side.
IDPM	Part ID for the tool (master) side.
GAP	A distance, which defines the minimum gap required.
NRSST	Normal direction of blank: EQ.0: the normal to the surface of the blank is pointing towards the tool, EQ.1: the normal to the surface of the blank is pointing away from the tool.
NRMST	Normal direction of tool: EQ.0: the normal to the surface of the tool is pointing towards the blank, EQ.1: the normal to the surface of the tool is pointing away from blank.

**Remarks:**

This option requires consistent normal vectors for both the rigid tooling surface and the blank surface.

**\*CONTROL\_FORMING\_SCRAP\_FALL**

Purpose: This keyword allows for contact-based trimming of scrap fall simulation in a sheet metal stamping press.

Card 1            1            2            3            4            5            6            7            8

Variable	PID	VECTID	NDSET	LCID	DEPTH	DIST		
Type	I	I	I	I	F	F		
Default	none	none	none	none	none	none		

**Cards 2, 3, 4, 5... repeat Card 1 as many times as needed to define multiple scrap pieces. The next "\*" card terminates the input.**

<u>VARIABLE</u>	<u>DESCRIPTION</u>
PID	Part ID of the scrap piece to be trimmed away.
VECTID	Vector ID for a trim steel movement, as defined by *DEFINE_VECTOR.
NDSET	A node set consists of all nodes along the cutting edge of the trim steel.
LCID	Load curve ID governing the trim steel kinematics, as defined by *DEFINE_CURVE. GT.0: velocity-controlled kinematics LT.0: displacement-controlled kinematics An example input deck is provided below.
DEPTH	A small penetrating distance between the cutting edge of the trim steel and the scrap piece. Nodes along the scrap edge are released from automatically-added constraints and free to move after this distance is reached.
DIST	A distance tolerance measured in the plane normal to the trim steel moving direction, between nodes along the cutting edge of the trim steel defined by NDSET and nodes along edge of the scrap.

**Remarks:**

1. As shown in the following figures, scrap piece, modeled as a deformable body, and parent piece are to be modeled as separate part IDs. The parent piece can be modeled as a rigid body and can be fixed throughout the simulation. Nodes along the trim line on both sides of the scrap and parent piece do not need to have the same coordinates. A small gap ( $< 2\text{mm}$ ) between the nodes on the scrap side and the nodes on the parent side is permissible. Nodes along the trim edge of the trim steel, modeled as a rigid body, is to be included in a node set, which will be used to determine the release of the constraints along the corresponding edge nodes on the scrap piece. In the beginning of the simulation, constraints are added automatically on the nodes along the scrap edge corresponding to the node sets along the trim steel. As trim steel comes into contact with the scrap piece, the constraints are removed accordingly. Kinematics and dynamics of the trim steel is carried onto the scrap piece through the defined contact interfaces.
2. The value of DEPTH is typically half of the scrap thickness. A very small SLSFAC (0.001~0.01) is recommended in the \*CONTROL\_CONTACT keyword.
3. The variable DIST should be slightly larger than the maximum gap between the nodes on the scrap side and the nodes on the trim post. It is critical that nodes along the scrap edge to be separated do not overlap the nodes along the corresponding edge on the trim post.
4. No parameters are allowed in \*DEFINE\_CURVE for the definition of the trim steel kinematics.
5. Only \*CONTACT\_FORMING type of contact interfaces are allowed with this keyword, and \*CONTACT\_FORMING\_SURFACE\_TO\_SURFACE is recommended between the scrap piece and the trim steel. Negative contact offset using variable MST must be used, and it is typically set to the same value of the scrap thickness. For contact between scrap piece and all other die structures, Contact types, either \*CONTACT\_AUTOMATIC\_GENERAL, or \*CONTACT\_SINGLE\_SURFACE are recommended. All coefficient of friction values need to be very small.
6. Explicit dynamics method is recommended for the scrap fall simulation. Very little or no mass scaling along with a reasonable trim steel kinematics are essential for a realistic simulation.
7. The node set defined along the trim steel edge must be in a consecutive order, and can be created with LSPP3.1, via Model/CreEnt/Cre, Set Data, \*SET\_NODE, ByPath. Select nodes along an element edge continuously until finish and then hit Apply.
8. A partial example of using the keyword below includes a node set ID 9991 along the trim steel (PID 2) edge used to release the constraints between the scrap piece with PID 1, and the parent piece. The LCID for the trim steel kinematics is (+)33 (load curve is controlled by velocity) moving in  $-Z$  direction. The trimming velocity is defined as 1000 mm/s and the retracting velocity is 4000 mm/s. The variables DEPTH and DIST are set to 0.01 and 2.5, respectively. The contact interface between the trim steel and scrap piece is defined

# \*CONTROL

# \*CONTROL\_FORMING\_SCRAP\_FALL

using \*CONTACT\_FORMING\_SURFACE\_TO\_SURFACE and all parts are included in a single surface contact.

```
*KEYWORD
*CONTROL_TERMINATION
&endtime
*CONTROL_FORMING_SCRAP_FALL
$      PID      VECTID      NDSET      LCID      DEPTH      DIST
      1
      9991      33      0.75      2.0
*SET_NODE_LIST
  9991
  24592      24591      24590      24589      24593      24594      24595      24596
*BOUNDARY_PRESCRIBED_MOTION_rigid
$pid,dof,vad,lcid,sf,vid,dt,bt
2,3,0,33,-1.0
*DEFINE_CURVE
33
0.0,0.0
0.216,1000.0
0.31,-4000.0
0.32,0.0
0.5,0.0
$---+-----1-----+-----2-----+-----3-----+-----4-----+-----5-----+-----6-----+-----7-----+-----8
*CONTACT_forming_surface_to_surface_ID
  1
  1      2      3      3      0      0      0      0
  0.02      0.0      0.0      0.0      20.0      0      0.01.0000E+20
$#      sfs      sfm      sst      mst      sfst      sfmt      fsf      vsf
  0.0      0.0      0.0      &mst      1.0      1.0      1.0      1.0
$---+-----1-----+-----2-----+-----3-----+-----4-----+-----5-----+-----6-----+-----7-----+-----8
*CONTACT_single_surface_ID
  2
  0      0      5      0      0      0      0      0
  0.02      0.0      0.0      0.0      20.0      0      0.01.0000E+20
  0.0      0.0      0.0      0.0      1.0      1.0      1.0      1.0
.....
*END
```

For the negative option of LCID, displacement will be used as input to control the tool kinematics. A partial example is provided below, where LCID is defined as a negative integer of a load curve, controlling the trim steel kinematics. The trim steel is moving down for 27.6075 mm in 0.2 sec to trim, and moving up for the same distance to its original position in 0.3 sec to retract. Although this option is easier to use, the corresponding velocity from the input time and displacement must be realistic for a realistic simulation.

```
*CONTROL_FORMING_SCRAP_FALL
$ LCID<0: trimming steel kinematics is controlled by displacement.
$      PID      VECTID      NDSET      LCID      DEPTH      DIST
      1
      44      1      -33332      0.70      2.00
*DEFINE_VECTOR
44,587.5,422.093,733.083,471.104,380.456,681.412
*BOUNDARY_PRESCRIBED_MOTION_rigid_LOCAL
$pid,dof,vad,lcid,sf,vid,dt,bt
11,3,2,33332,1.0,44
*DEFINE_CURVE
33332
0.0,0.0
0.2,-27.6075
0.5,0.0
```

- 9. This feature is available in LS-DYNA R5 Revision 63618 or later releases. Latest beta release provides enhanced capabilities.

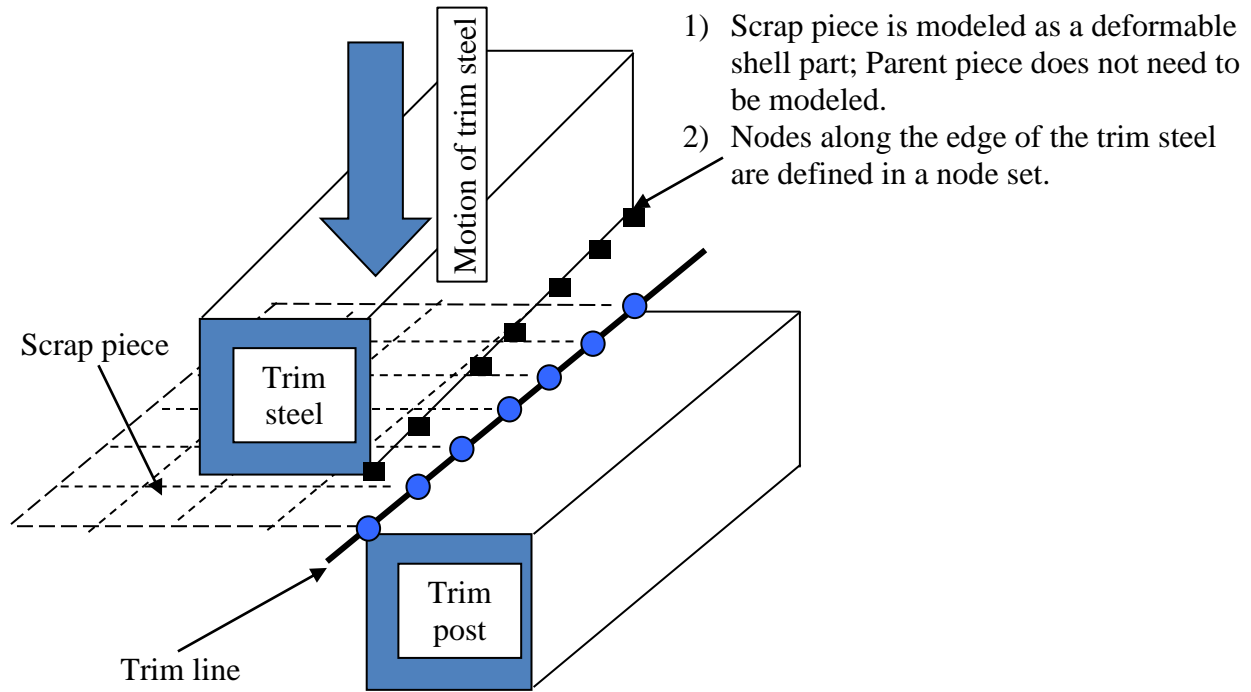


Figure 11.4. Modeling details for the scrap fall simulation (Courtesy of Ford Motor Company)

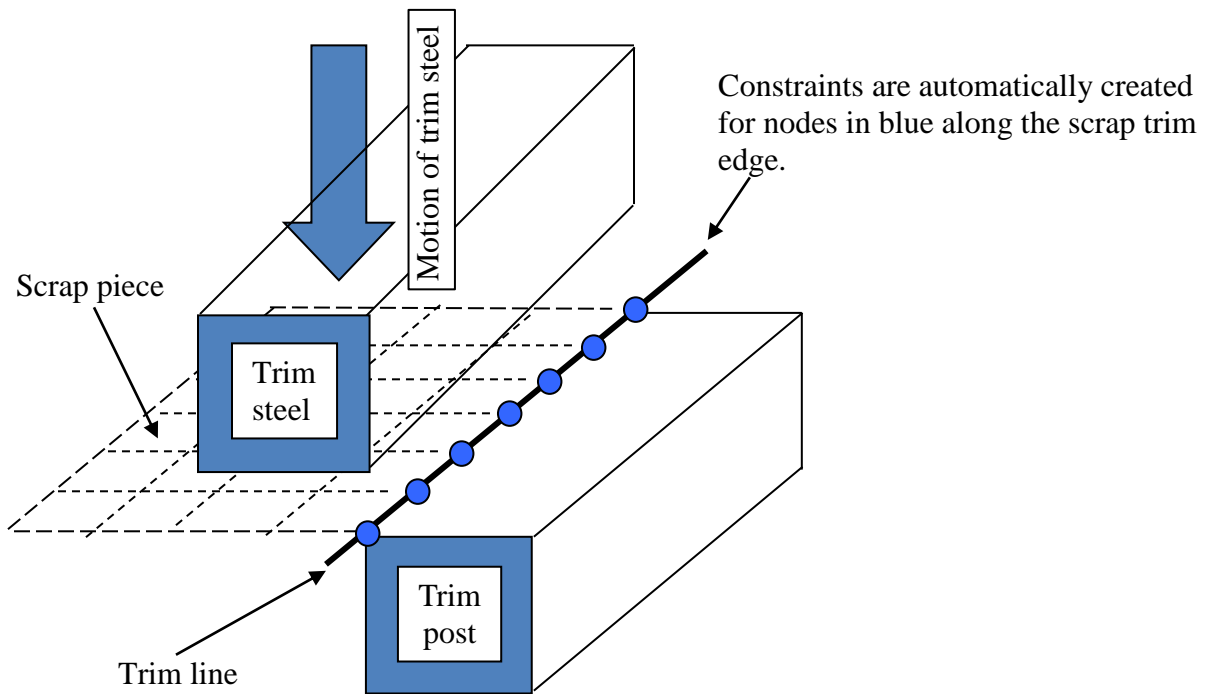
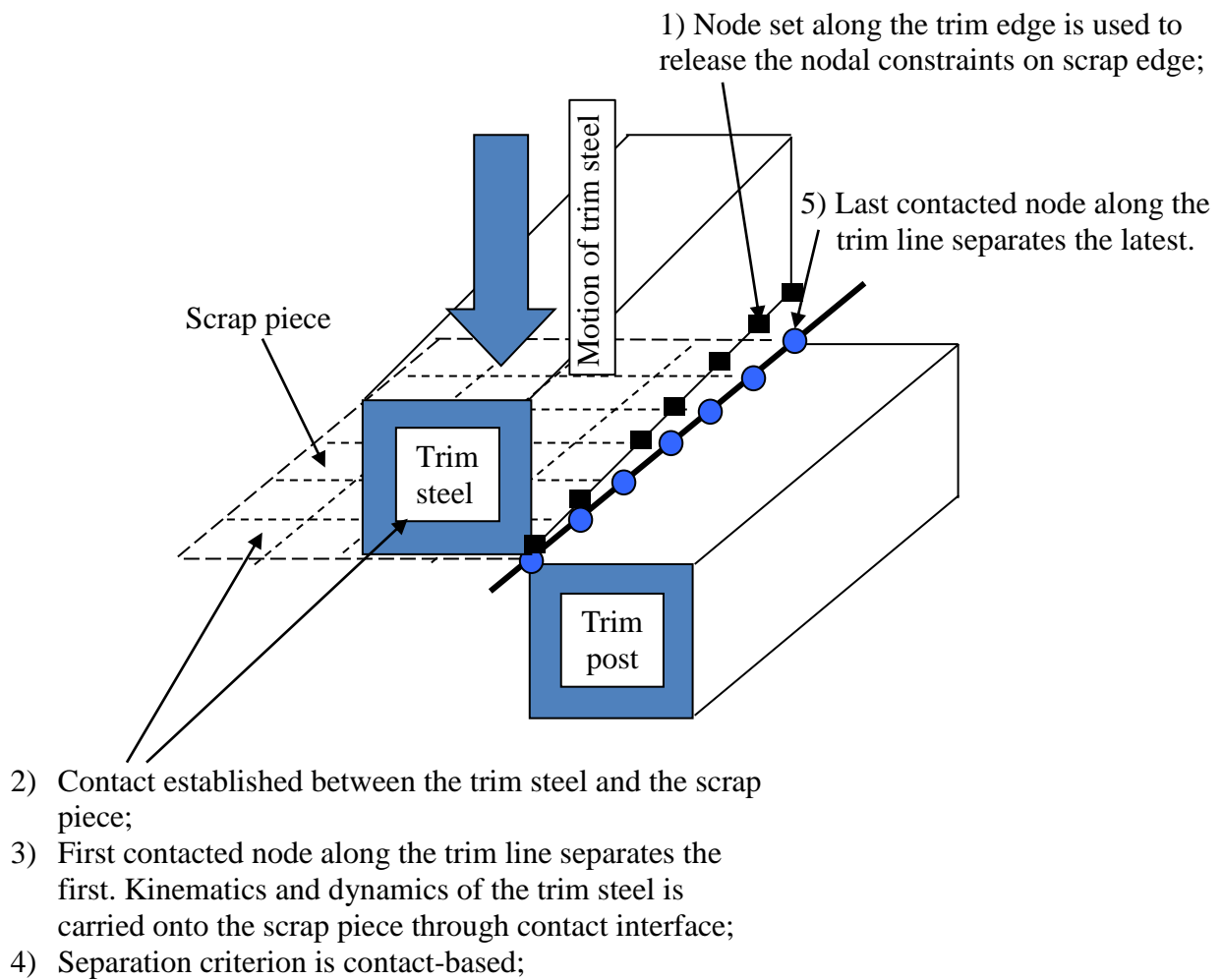


Figure 11.5. Simulation initialization (Courtesy of Ford Motor Company)



**Figure 11.6.** Contact-based separation and contact-driven kinematics and dynamics  
(Courtesy of Ford Motor Company)



\*CONTROL\_FORMING\_STONING

Purpose: This feature is developed to detect surface lows or surface defects formed during metal stamping. This calculation is typically performed after a springback simulation. A curvature-based method is implemented with the feature. Users have the option to check an entire part or just a few local areas, defined by node set or shell element set. In each area, direction of the stoning action can be specified by two nodes (see **Remarks** below) or simply allow the program to automatically determine the stoning direction.

Card 1            1            2            3            4            5            6            7            8

Variable	ISTONE	LENGTH	WIDTH	STEP	DIRECT	REVERSE	METHOD	
Type	I	F	F	F	F	I	I	
Default	None	0.0	0.0	0.0	0.0	0	0	

Card 2            1            2            3            4            5            6            7            8

Variable	NODE1	NODE2	SID	ITYPE	V1	V2	V3	
Type	I	I	I	I	F	F	F	
Default	0	0	0	0	0.0	0.0	0.0	

<u>VARIABLE</u>	<u>DESCRIPTION</u>
ISTONE	Stoning calculation option. EQ.1: calculate panel surface quality using stoning method.
LENGTH	Length of the stone.
WIDTH	Width of the stone.
STEP	Stepping size of the moving stone.
DIRECT	Number of automatically determined stoning direction(s).

---

<b>VARIABLE</b>	<b>DESCRIPTION</b>
REVERSE	Surface normal reversing option. EQ.0: do not reverse surface normals. EQ.1: reverse surface normals.
METHOD	Stoning method. EQ.0: curvature-based method.
NODE1	Tail node defining stoning moving direction.
NODE2	Head node defining stoning moving direction.
SID	Node or shell set ID.
ITYPE	Set type designation. EQ.1: node set. EQ.2: element set.
V1, V2, V3	Vector components defining stoning direction (optional).

**Remarks:**

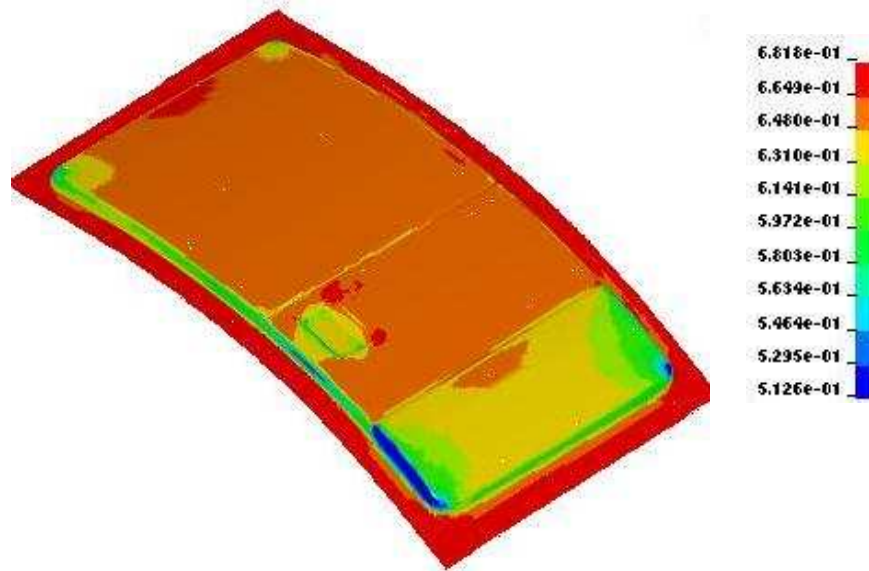
1. Stoning is a quality checking process on class-A exterior stamping panels. Typically the long and wider surfaces of an oil stone of a brick shape are used to slide and scratch in a given direction against a localized area of concern on a stamped panel. Surface ‘lows’ are shown where scratch marks are not visible and ‘highs’ are shown in a form of scratch marks. This keyword is capable of predicting both the surface ‘lows’ and ‘highs’. Since stoning process is carried out after the stamping (either drawn or trimmed) panels are removed from the stamping dies, a springback simulation needs to be performed prior to conducting a stoning analysis.
2. As a reference, typical stone length and width can be set at 150.0 and 30.0 mm, respectively.
3. The Step size of the moving stone is typically in the order of the element length. The smallest element length can be selected as the step size.
4. The variable DIRECT allows for the automatic definition of the stoning directions. Any number can be selected but typically ‘2’ is used. Although CPU time required for the stoning calculation is trivial, a larger DIRECT consumes more CPU time.
5. Stoning is performed on the outward normal side of the mesh. Element normals must be oriented accordingly and consistently. Alternatively, the variable REVERSE provides an easy way to reverse the element normals in the solver before the computation.

6. Variables NODE1 and NODE2 are used to define a specific stoning direction. The stone is moved in the direction defined by NODE1 to NODE2. Alternatively, one can leave NODE1 and NODE2 blank and define the number of automatically determined stoning directions by using DIRECT. Furthermore, stoning direction can also be defined using a vector by defining V1, V2, V3.
7. The blank model intended for analysis can be included using keyword \*INCLUDE. If nothing is defined for SID and ITYPE then the entire blank model included will be used for stoning analysis.
8. A large area mesh can be included in the input file. An ELSET must also be included, which defines a local area that requires stoning computation. Alternatively, an ELSET can define several local areas to be used for the computation. Furthermore, an ELSET should not include meshes that have reversed curvatures. An ELSET can be easily generated using LS-PrePost, in page 5, under SetD.
9. Since stoning requires high level of accuracy in springback prediction, it is recommended that the SMOOTH option in keyword \*CONTACT\_FORMING\_ONE\_WAY\_SURFACE\_TO\_SURFACE to be used during the draw forming simulation. Not all areas require SMOOTH contact, only areas of interest may apply. In addition, meshes in the areas of concern need to be very fine, with average element size of 1 to 2 mm. Mesh adaptivity is not recommended. Mass scaling with DT2MS needs to be sufficiently small to reduce the dynamic effect during forming. For binder closing of large exterior panel, implicit static method using \*CONTROL\_IMPLICIT\_FORMING type 2 is recommended.
10. It is recommended that double precision version of LS-DYNA be used for this application.
11. The output of the stoning simulation results is in a file named “filename.output”, where “filename” is the name of the LS-DYNA stoning input file contains this keyword, without the file extension. The stoning results can be viewed using LS-PrePost, in page 1, under FCOMP/Thick/ Shell\_Thickness.
12. The stoning feature is available in LS-DYNA R5 Revision 54398 or later releases. Vector component option is available in R5 Revision 60829 or later releases. An example of a stoning analysis on a Ford Econoline door outer panel is provided below for reference. The original part model comes from National Crash Analysis Center at The George Washington University. The complete input deck used for the stoning simulation is provided below for reference; where, a local area mesh of the door handle after springback simulation ‘Doorhandle.k’ and an element set ‘elset1.k’ are included in the deck.

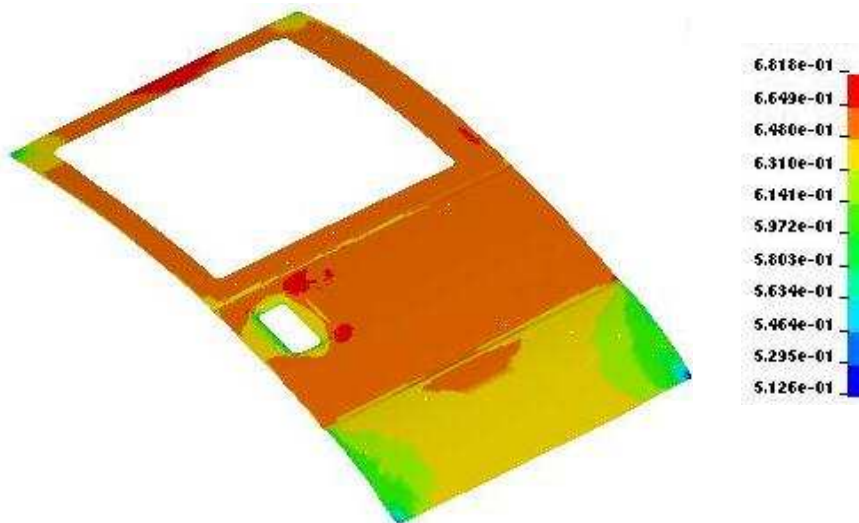
# \*CONTROL

# \*CONTROL\_FORMING\_STONING

```
*KEYWORD
*TITLE
Stoning Analysis
*INCLUDE
Doorhandle.k
*INCLUDE
elset1.k
*CONTROL_FORMING_STONING
$  ISTONE   LENGTH   WIDTH   STEP   DIRECT  REVERSE  METHOD
    1       150.0    4.0     1.0     2        0         0
$  NODE1    NODE2     SID     ITYPE
    1        1        1        2
*END
```



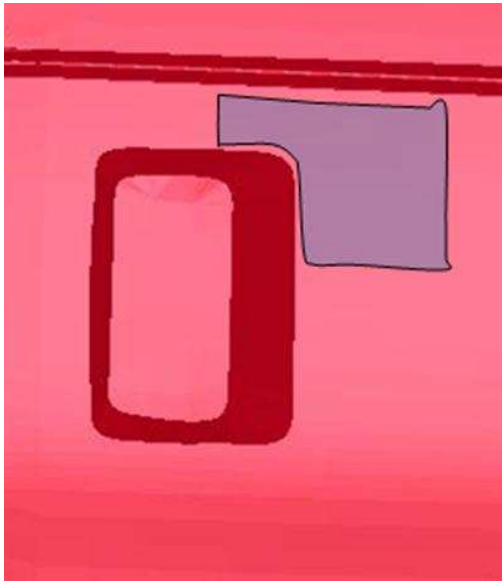
Thickness contour of the panel after draw simulation



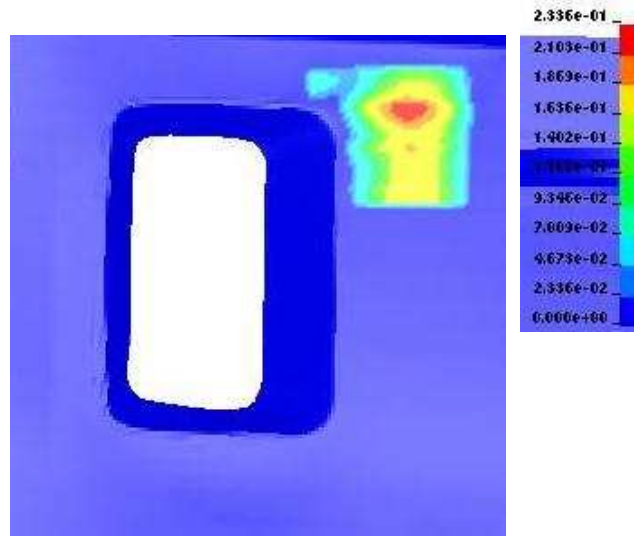
Thickness contour of the panel after trimming



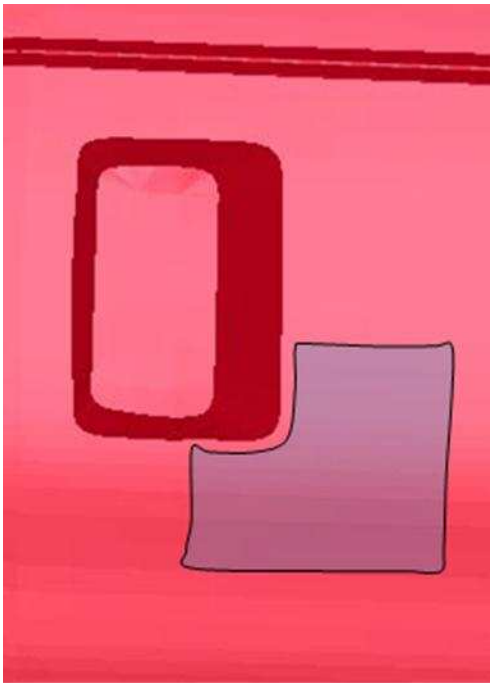
Springback amount (mm) in Z is shown in the figure below.



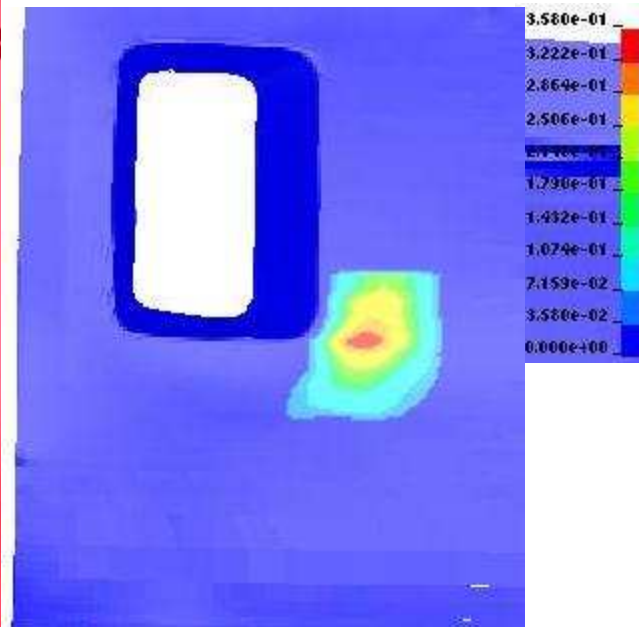
The element sets selected for stoning



Stoning results



The element sets selected for stoning



Stoning results

**\*CONTROL\_FORMING\_TEMPLATE**

Purpose: This keyword is used to simplify the required input for sheet metal stamping simulations. With this keyword, five templates are given: three-piece air draw, three-piece toggle draw, four-piece draw, trimming, and springback.

Card 1            1            2            3            4            5            6            7            8

Variable	IDTEMP	BLKID	DIEID	PNCH	BNDU	BNDL	TYPE	PREBD
Type	I	I	I	I	I	I	I	F
Default	none	none	none	none	none	none	0	0.0
Remarks	1	2						

Card 2            1            2            3            4            5            6            7            8

Variable	LCSS	AL/FE	R00	R45	R90	E	DENSITY	PR
Type	I	C	F	F	F	F	F	F
Default	none	Fe	1.0	R00	R00	none	none	none

Card 3            1            2            3            4            5            6            7            8

Variable	K	N	MTYP	UNIT	THICK	GAP	FS	
Type	F	F	I	I	F	F	F	
Default	none	none	37	1	none	1.1t	0.1	

# \*CONTROL

# \*CONTROL\_FORMING\_TEMPLATE

Card 4            1            2            3            4            5            6            7            8

Variable	PATERN	VMAX	VX	VY	VZ	VID	AMAX	
Type	I	F	F	F	F	I	F	
Default	1	1000	0	0	-1	none	1.0e+6	

Card 5            1            2            3            4            5            6            7            8

Variable	LVLADA	SIZEADA	TIMSADA	D3PLT				
Type	I	F	I	I				
Default	1	none	20	10				

## VARIABLE

## DESCRIPTION

IDTEMP	Type of forming process (See Remarks below.) EQ.1: 3-piece air-draw EQ.2: 3-piece Toggle-draw EQ.3: 4-piece draw EQ.4: Springback EQ.5: Trimming
BLKID	Part or part set ID (see TYPE) that defines the blank.
DIEID	Part or part set ID that defines the die. See Figures 11.7a, 11.7b and 11.7c for more information
PNCHID	Part or part set ID that defines the punch.
BNDUID	Part or part set ID that defines the upper binder.
BNDLID	Part or part set ID that defines the lower binder.



<b>VARIABLE</b>	<b>DESCRIPTION</b>
TYPE	Flag for part or part set ID used in the definition of BLKID, DIEID, PNCHID, BNDUID, and BNDLID. EQ.0: Part ID, EQ.1: Part set ID.
PREBD	Distance between the lower binder and punch in the 4 piece draw. See Figure 11.7c for more information.
LCSS	If the material for the blank is not user defined, this curve ID will define the stress-strain relationship; otherwise, this curve is ignored.
AL/FE	This parameter is used to define the Young's Modulus and density of the blank. If this parameter is defined, E and DENSITY will be defined in the units given by UNIT below. EQ.A: the blank is aluminum EQ.F: the blank is steel (default)
R00, R45, R90	Material anisotropic parameters. For transverse anisotropy the R value is set to the average value of R00, R45, and R90.
E	Young's Modulus. If AL/FE is user defined, E is unnecessary
DENSITY	Material density of blank. If AL/FE is user defined, this parameter is unnecessary
PR	Poisson's ratio.
K	Strength coefficient for exponential hardening. If LCSS is defined, or if a blank material is user defined, this parameter is ignored. ( $\bar{\sigma} = k\bar{\epsilon}^n$ )
N	Exponent for exponential hardening. If LCSS is defined, or if a blank material is user defined, this parameter is ignored.
MTYP	Material model types 36 and 37 are supported: *MAT_3-PARAMETER_BARAT and *MAT_TRANSVERSELY_ANISOTROPIC_ELASTIC_PLASTIC, respectively.
UNIT	Units adopted in this simulation. Define a number between 1 and 10. See Table 11.1 to determine the value for UNIT. This unit is used to obtain proper punch velocity, acceleration, time step, and material properties.
THICK	Blank thickness. If the blank thickness is already defined, this parameter is ignored.

<b>VARIABLE</b>	<b>DESCRIPTION</b>
GAP	The home gap between rigid tools for automatic positioning and tooling motion. If *BOUNDARY_PRESCRIBED_RIGID_BODY is user defined, this parameter is ignored. The default is 1.1 x blank thickness.
FS	Friction coefficient (default=0.10). If the contact is user defined, this parameter is ignored.
PATERN	Velocity profile of moving tool. If the velocity is user defined by *BOUNDARY_PRESCRIBED_RIGID_BODY, PATERN is ignored. EQ.1: Ramped velocity profile EQ.2: Smooth velocity curve
VX, VY, VZ	Vector components defining the direction of the movement of the punch. The default direction is defined by VID
VID	VID is the vector ID defining the direction of the movement of the punch. The vector, VID, overrides the vector (VX, VY, VZ). If VID and (VX, VY, VZ) are undefined, the punch is assumed to move in the negative z-direction.
AMAX	The maximum allowable acceleration.
LVLADA	Maximum adaptive level.
SIZEADA	Minimum element size permitted in the adaptive mesh.
TIMSADA	Total number of adaptive steps during the forming simulation.
D3PLT	The total number of output states in the D3PLOT database.

UNIT	1	2	3	4	5	6	7	8	9	10
Mass	Ton	Gm	Gm	Gm	Gm	Kg	Kg	Kg	Kg	Kg
Length	Mm	Mm	Mm	Cm	Cm	Mm	Cm	Cm	Cm	m
Time	S	Ms	S	Us	S	Ms	Us	Ms	S	S
Force	N	N	1.e-6N	1e7N	Dyne	KN	1e10N	1e4N	1e-2N	N

Table 11.1 Available units for metal stamping simulations.

## IDTEMP = 1: 3-Piece Air-Draw

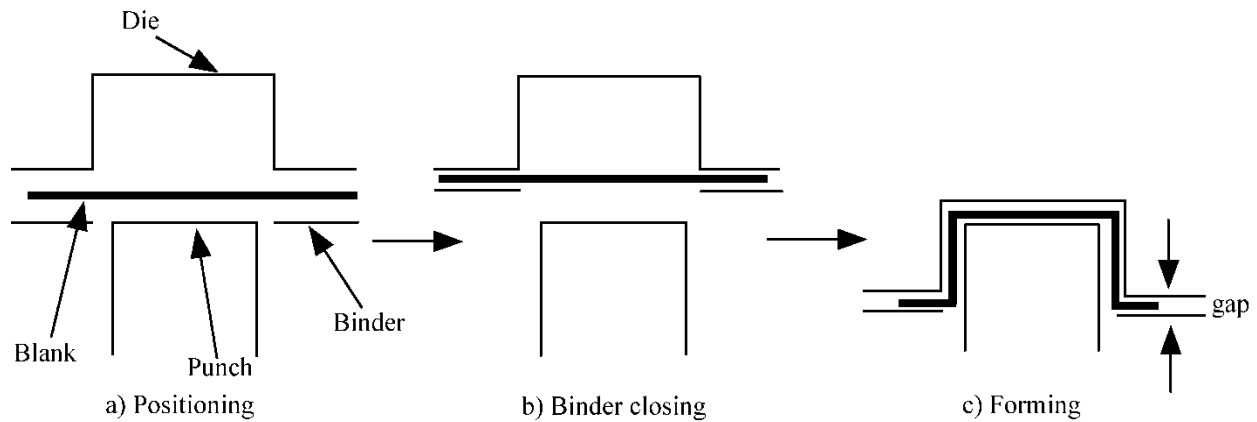


Figure 11.7a

## IDTEMP = 2: 3-Piece Toggle Draw

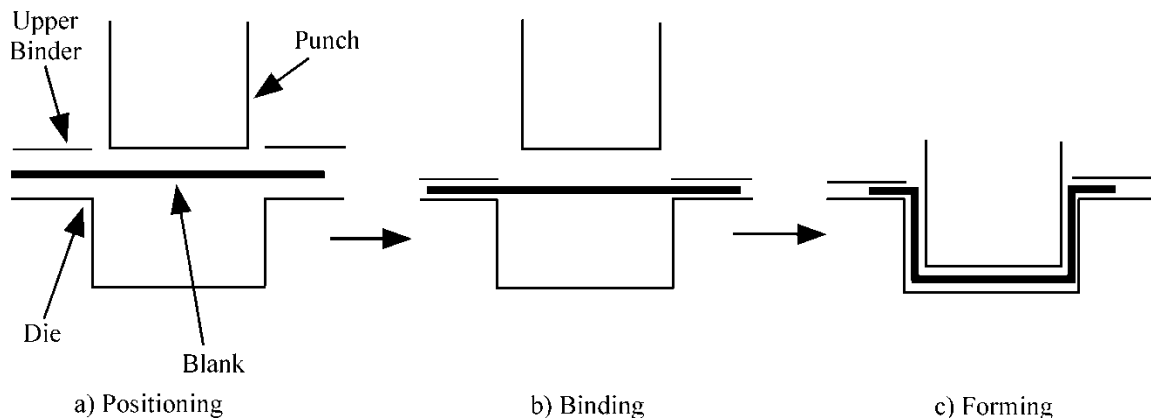
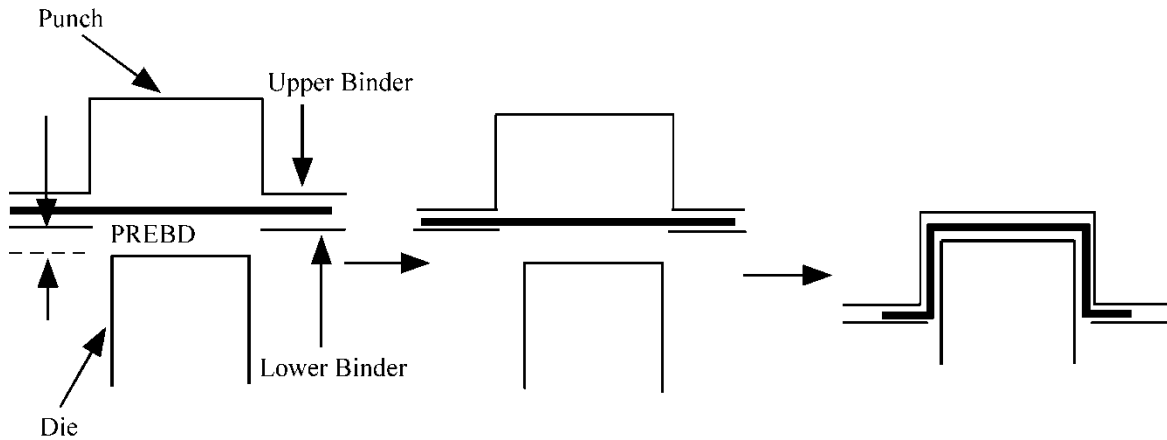


Figure 11.7b

- Notes:
1. In step a), LS-DYNA will automatically position the tools and minimize the punch travel.
  2. In steps b) and c), LS-DYNA will calculate the binder and punch travel based on the blank thickness and the home gap.
  3. Termination time will be automatically set based on b) and c).
  4. The rigid body motion of the tooling is automatically defined.
  5. All the contacts between the blank and rigid tools are defined.
  6. All necessary control parameters are defined.
  7. If user defines any of the parameter, it will override the automatic setting
  8. User does not need to use keywords, such as \*PART, \*CONTROL, \*SECTION,

\*MAT\_..., \*CONTACT\_...(Drawbead definition is an exception),  
\*BOUNDARY\_PRESCRIPTION\_RIGID, etc.

**IDTEMP=3: Four-Piece Draw**

**Figure 11.7c**

Note: a) PREBD is used for the preposition of the lower  
b) First, upper binder goes down to meet lower binder  
c) Second, lower binder and upper binder move together and move to the home position  
d) Third, punch move down to its home position

**IDTEMP=4 Springback Simulation**

Note: The necessary keywords, excluding this one, are \*BOUNDARY to specify the constraints, and keywords include in dynain file. A new dynain file will be automatically output.

**IDTEMP=5 Trimming operation**

Note: The necessary keywords, excluding this one, are \*DEFINE\_CURVE\_TRIM, and keywords included in dynain file.

**\*CONTROL\_FORMING\_TIPPING**

Purpose: This keyword is developed to reorient or reposition a part between the stamping dies. In stamping line die simulation, panel tipping and translation between the die stations are frequently required. Typically such transformation involves only a small amount of rotations, e.g. < 15 degrees; and some large amounts of translation. For example, there could be a tipping angle of 10 degree along Y-axis and a translation of 2000 mm along the X-axis between the current trimming die and next flanging die.

**Cards 1,2,3,4, ... (the next “\*” card terminates the input)**

Card 1            1            2            3            4            5            6            7            8

Variable	PID/SID	ITYPE	ISTRAIN	IFSTRSS	NMOVE			
Type	I	I	I	I	I			
Default	none	none	0	0	0			

**Card 2 for rotation:**

Card 2            1            2            3            4            5            6            7            8

Variable	ROT/ TRAN	V11	V12	V13	X01	Y01	Z01	DISTA1
Type	I	F	F	F	F	F	F	F
Default	none	0.0	0.0	0.0	0.0	0.0	0.0	0.0

**Card 2 for translation:**

Card 2            1            2            3            4            5            6            7            8

Variable	ROT/ TRAN	DX	DY	DZ				
Type	I	F	F	F				
Default	none	0.0	0.0	0.0				

<b>VARIABLE</b>	<b>DESCRIPTION</b>
PID/SID	Part ID or part set ID of part(s) that requires tipping and/or translation.
ITYPE	Part ID or part set ID indicator: EQ.1: PID means part ID, EQ.2: PID/SID means part set ID.
ISTRAIN	Strain tensors inclusion option: EQ.1: include in tipping/translation.
ISTRSS	Stress tensors inclusion option: EQ.1: include in tipping/translation.
NMOVE	Total number of tipping and translation intended with this keyword.
ROT/TRAN	Transformation type: EQ.1: rotation, EQ.2: translation.
V11, V12, V13	Vector components of an axis about which tipping is performed.
X01, Y01 & Z01	X, Y and Z coordinates of a point through which the tipping axis passes.
DSITA	Tipping angle in degree.
DX, DY, DZ	Translation distances along global X-axis, Y-axis and Z-axis.

**Remarks:**

1. Keyword \*INCLUDE can be used to include the file to be tipped or translated.
2. Tipping angle DISTA1 is defined in degree. Signs of the tipping angles follow the 'right hand rule'.
3. An example of the keyword is included below, to tip a part +23.0 degrees, -31.0 degrees, and +8.0 degrees about X-, Y-, and Z-axis, respectively and passing through the origin; and to translate the part 12.0mm, -6.0mm and 91.0mm along X-, Y-, and Z-axis, respectively.

```

*INCLUDE
trimmedpart.dynain
*CONTROL_FORMING_TIPPING
$ PID/PSID      ITYPE      ISTRAIN      ISTRSS      NMOVE
      1          0          1            1            4
$ ROT/TRAN      V11         V12          V13          X01          y01          z01          DSITA1
      1          1.000      0.000000    0.000        0.000        0.000        0.000        23.0
$ ROT/TRAN      V21         V22          V23          X21          y21          z21          DSITA2
      1          0.000      1.000000    0.000        0.000        0.000        0.000        -31.0
$ ROT/TRAN      V31         V32          V33          X31          y31          z31          DSITA3
      1          0.000000    0.000        1.000        0.000        0.000        0.000        8.0

```

---

\$ ROT/TRAN	DX	DY	DZ
2	12.0	-6.0	91.0

4. This feature is available in LS-DYNA R4 Revision 53448 and later releases.

**\*CONTROL\_FORMING\_TRAVEL**

Purpose: Provide a simple interface for arbitrary stamping analysis. This keyword provides information on how to move the tools in each phase. This keyword should be used with \*CONTROL\_FORMING\_POSITION and \*CONTROL\_FORMING\_USER.

Card 1            1            2            3            4            5            6            7            8

Variable	PID	VID	TRAVEL	TARGET	GAP	PHASE	FOLLOW	
Type	I	I	F	I	F	I	I	
Default	none	none	none	none	none	none	none	

**VARIABLE****DESCRIPTION**

PID	Part ID of tool.
VID	Vector ID defining the direction of travel for the tool defined by PID.
TRAVEL	Move tool this distance in the direction specified by the VID. If TRAVEL is defined, it is not necessary to define TARGET.
TARGET	Move tool (PID) to meet the TARGET, where the TARGET is the part ID of the matching tool.
GAP	The minimum distance between tool and TARGET in the home position. The GAP is by default the blank thickness.
PHASE	Phase number. Start sequentially from 1. For example, phase 1 is the binder closing, and phase 2 is the stamping operation.
FOLLOW	The tool (PID) can also move by following the part ID, FOLLOW. During this phase, the distance between the tool (PID) and part ID, FOLLOW, will be constant.



**\*CONTROL\_FORMING\_USER****\*CONTROL****\*CONTROL\_FORMING\_USER**

Purpose: To provide a simple interface for arbitrary stamping analysis. It provides blank material information. This keyword should be used with \*CONTROL\_FORMING\_POSITION and \*CONTROL\_FORMING\_TRAVEL.

Card 1            1            2            3            4            5            6            7            8

Variable	BLANK	TYPE	THICK	R00	R45	R90	AL/FE	UNIT
Type	I	I	F	F	F	F	A	I
Default	none	0	none	1.0	R00	R00	F	1

Card 2            1            2            3            4            5            6            7            8

Variable	LCSS	K	N	E	DENSITY	PR	FS	MTYPE
Type	I	F	F	F	F	F	F	I
Default	none	none	none	none	none	none	0.1	37

Card 3            1            2            3            4            5            6            7            8

Variable	PATERN	VMAX	AMAX	LVLADA	SIZEADA	ADATIMS	D3PLT	GAP
Type	I	F	F	I	F	I	I	F
Default	1	1000.0	500000.	0	0	0	10	1.1t

**VARIABLE****DESCRIPTION**

BLANK

Blank ID

---

<b>VARIABLE</b>	<b>DESCRIPTION</b>
TYPE	Flag for part or part set ID. EQ.0: Part ID, EQ.1: Part set ID.
THICK	Blank thickness. If the blank thickness is already defined, this parameter is ignored.
R00, R45, R90	Material anisotropic parameters. For transverse anisotropy the R value is set to the average value of R00, R45, and R90.
AL/FE	This parameter is used to define blank Young's Modulus and density. If this parameter is defined, E and Density will be found by using the proper unit, which is specified below. EQ.A: the blank is aluminum EQ.F: the blank is steel (default)
UNIT	Units adopted in this simulation. Define a number between 1 and 10. See Table 11.1 to determine the value for UNIT. This unit is used to obtain proper punch velocity, acceleration, time step, and material properties.
LCSS	If the material for the blank has not been defined, this curve will be used to define the stress-strain relation. Otherwise, this curve is ignored.
PREBD	Distance between the lower binder and punch in the 4 piece draw. See Figure 11.7c for more information.
K	Strength coefficient for exponential hardening. If LCSS is defined, or if a blank material is user defined, this parameter is ignored. ( $\bar{\sigma} = k\bar{\epsilon}^n$ )
N	Exponent for exponential hardening. If LCSS is defined, or if a blank material user defined, this parameter is ignored.
E	Young's Modulus. If AL/FE is user defined, E is unnecessary.
DENSITY	Material density of blank. If AL/FE is user defined, this parameter is unnecessary.
PR	Poisson's ratio. If AL/FE is user defined, E is unnecessary.
FS	Friction coefficient. If contact is defined, this parameter is ignored.
MTYP	Material model types 36 and 37 are supported: *MAT_3-PARAMETER_BARAT and *MAT_TRANSVERSELY_ANISOTROPIC_ELASTIC_PLASTIC, respectively.

---

<b>VARIABLE</b>	<b>DESCRIPTION</b>
PATERN	Velocity profile of moving tool. If the velocity is user defined by *BOUNDARY_PRESCRIBED_RIGID_BODY, PATERN is ignored. EQ.1: Ramped velocity profile EQ.2: Smooth velocity curve
VMAX	The maximum allowable tool velocity
AMAX	The maximum allowable acceleration.
LVLADA	Maximum adaptive level.
SIZEADA	Minimum element size permitted in the adaptive mesh.
ADATIMS	Total number of adaptive steps during the forming simulation.
D3PLT	The total number of output states in the D3PLOT database.
GAP	Minimum gap between tools.

**\*CONTROL\_HOURLASS\_{OPTION}**

Available options include:

**<BLANK>**

**936**

which switches the hourglass formulation so that it is identical to that used in LS-DYNA version 936. The modification in the hourglass control from version 936 was to ensure that all components of the hourglass force vector are orthogonal to rigid body rotations. However, problems that run under version 936 sometimes lead to different results in versions 940 and later. This difference in results is primarily due to the modifications in the hourglass force vector. Versions released after 936 should be more accurate.

Purpose: Redefine the default values of hourglass control type and coefficient.

Card                    1                    2                    3                    4                    5                    6                    7                    8

Variable	IHQ	QH							
Type	I	F							
Default		0.1							
Remarks	1,2	3,4							

<b>VARIABLE</b>	<b>DESCRIPTION</b>
IHQ	Default hourglass type: EQ.0: see note 1, EQ.1: standard LS-DYNA, EQ.2: Flanagan-Belytschko integration, EQ.3: Flanagan-Belytschko with exact volume integration, EQ.4: stiffness form of type 2 (Flanagan-Belytschko), EQ.5: stiffness form of type 3 (Flanagan-Belytschko), EQ.6: Belytschko-Bindeman [1993] assumed strain co-rotational stiffness form for 2D and 3D solid elements, EQ.7: Linear total strain form of type 6 hourglass control, EQ.8: Activates full projection warping stiffness for accurate solutions with type 16 fully integrated shell elements. A speed penalty of 25% is common for this option, EQ.9: Puso [2000] enhanced assumed strain stiffness form for 3D hexahedral elements, EQ.10: Cosserat Point Element (CPE) developed by Jabareen and Rubin [2008] for 3D hexahedral elements. See Remark 6.
QH	Default hourglass coefficient.

**Remarks:**

1. Hourglass control is viscosity or stiffness that is added to quadrilateral shell elements and hexahedral solid elements that use reduced integration. Without hourglass control, these elements would have zero energy deformation modes which could grow large and destroy the solution. \*CONTROL\_HOURLASS can be used to redefine the default values of the hourglass control type and coefficient. If omitted or if IHQ=0, the default hourglass control types are as follows:

For shells: viscous type (1=2=3) for explicit; stiffness type (4=5) for implicit  
For solids: type 2 for explicit; type 6 for implicit.

These default values are used unless HGID on \*PART is used to point to \*HOURLASS data which overrides the default values for that part.

For explicit analysis, shell elements can be used with either viscous hourglass control, (IHQ=1=2=3) or stiffness hourglass control (IHQ=4=5). Only shell form 16 uses warping stiffness invoked by IHQ=8. For implicit analysis, the viscous form is unavailable.

For explicit analysis, hexahedral elements can be used with any of the hourglass control types except IHQ=8. For implicit analysis, only IHQ=6, 7, 9, and 10 are available.

IHQ may be set to a value that is invalid for some elements in a model. If that happens, then the hourglass control type for those elements is automatically reset to a valid value. For explicit analysis, if IHQ=6, 7, 9, or 10, then shell elements will be switched to type 4 except for form 16 shells that are switched to type 8. If IHQ=8, then solid elements and shell elements that are not form 16 will be switched to type 4. For implicit analysis, if IHQ=1-5, then solid elements will be switched to type 6, and if IHQ=1, 2, 3, 6, 7, 9, or 10, then shell elements will be switched to type 4.

2. Viscous hourglass control has been used successfully with shell elements when the response with stiffness based hourglass control was overly stiff. As models have grown more detailed and are better able to capture deformation modes, there is less need for viscous forms. To maintain back compatibility, viscous hourglass control remains the default for explicit analysis, but there may be better choices, particularly the newer forms for bricks (6, 7, 9, and 10).
3. QH is a coefficient that scales the hourglass viscosity or stiffness. With IHQ=1 thru 6 and IHQ=8, values of QH that exceed 0.15 may cause instabilities. Hourglass types 6, 7, 9, and 10 will remain stable with larger QH and can work well with QH=1.0 for many materials. However, for plasticity models, a smaller value such as QH=0.1 may work better since the hourglass stiffness is based on elastic properties.
4. Hourglass types 6, 7, 9, and 10 for hexahedral elements are based on physical stabilization using an enhanced assumed strain method. When element meshes are not particularly skewed or distorted, their behavior may be very similar and all can produce accurate coarse mesh bending results for elastic material with QH=1.0. However, form 9 gives more accurate results for distorted or skewed elements. In addition, for materials 3, 18 and 24 there is the option to use a negative value of QH. With this option, the hourglass stiffness is based on the current material properties, i.e., the plastic tangent modulus, and scaled by  $|QH|$ .
5. Hourglass type 7 is a variation on form 6. Instead of updating the hourglass forces incrementally using the current stiffness and an increment of deformations, the total hourglass deformation is evaluated each cycle. This ensures that elements always spring back to their initial geometry if the load is removed. However the CPU time for type 7 is roughly double that for type 6, so it is only recommended when needed.
6. Hourglass type 10 for 1-point solid elements is a structural element based on Cosserat point theory that allows for accurate representation of elementary deformation modes (stretching, bending and torsion) for general element shapes and hyperelastic materials. To this end, the theory in Jabareen and Rubin [2008] has been generalized in the implementation to account for any material response. The deformation is separated into a homogenous and an inhomogeneous part where the former is treated by the constitutive law and the latter by a hyperelastic formulation that is set up to match analytical results for the deformation modes mentioned above. Tests have shown that the element is giving more accurate results than other hexahedral elements for small deformation problems.

**\*CONTROL\_IMPLICIT\_AUTO**

Purpose: Define parameters for automatic time step control during implicit analysis (see also \*CONTROL\_IMPLICIT\_GENERAL).

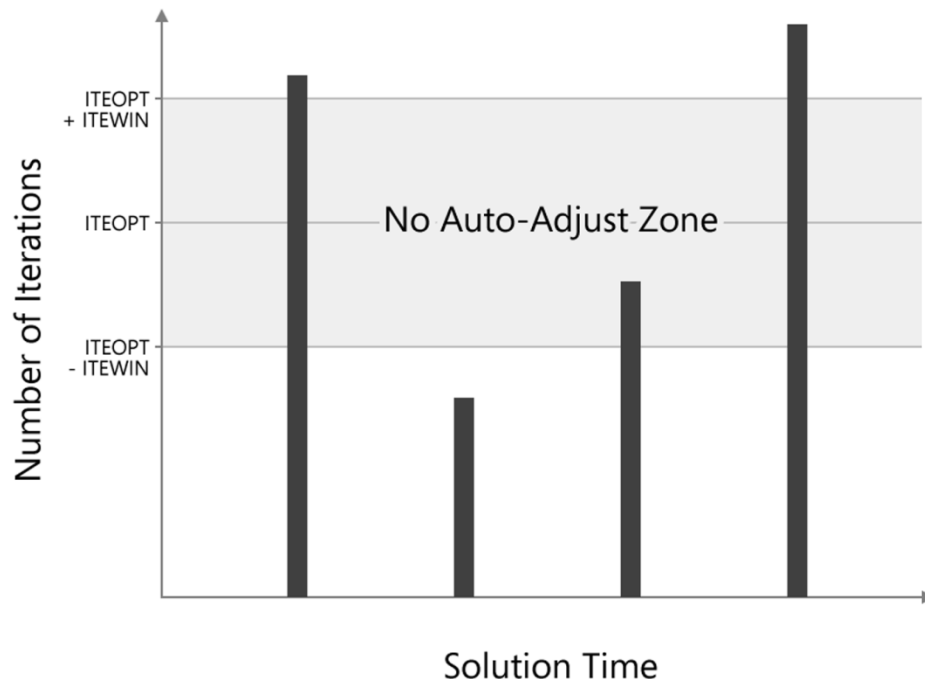
Card            1            2            3            4            5            6            7            8

Variable	IAUTO	ITEOPT	ITEWIN	DTMIN	DTMAX	DTEXP	KFAIL	KCYCLE
Type	I	I	I	F	F	F		
Default	0	11	5	DT/1000.	DT*10.	none		

**VARIABLE****DESCRIPTION**

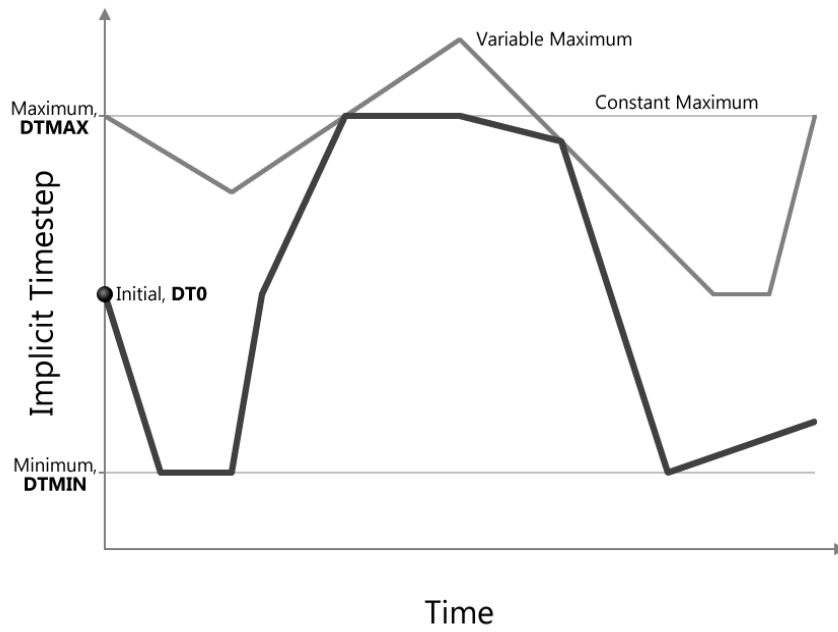
IAUTO	Automatic time step control flag EQ.0: constant time step size EQ.1: automatically adjusted time step size LT. 0: Curve ID = (-IAUTO) gives time step size as a function of time. If specified, DTMIN and DTMAX will still be applied.
ITEOPT	Optimum equilibrium iteration count per time step. See Figure 11.8.
ITEWIN	Defines range of allowable iteration window. If iteration count is within ITEWIN iterations of ITEOPT, step size will not be adjusted for the next step. In other words, the time step will be reduced if the iteration count to convergence is greater than ITEOPT+ITEWIN and the time step will be increased if the iteration count to convergence is less than ITEOPT-ITEWIN. See Figure 11.8.
DTMIN	Minimum allowable time step size. Simulation stops with error termination if time step falls below DTMIN.
DTMAX	Maximum allowable time step size. LT.0: curve ID = (-DTMAX) gives max step size as a function of time. Also, the step size is adjusted automatically so that the time value of each point in the curve is reached exactly (see Figures 11.9 and 11.10).

<b>VARIABLE</b>	<b>DESCRIPTION</b>
DTEXP	Time interval to run in explicit mode before returning to implicit mode. Applies only when automatic implicit-explicit switching is active (IMFLAG= 4 or 5 on *CONTROL_IMPLICIT_GENERAL). Also, see KCYCLE. EQ.0: defaults to the current implicit time step size. LT.0: curve ID = (-DTEXP) gives the time interval as a function of time.
KFAIL	Number of failed attempts to converge implicitly for the current time step before automatically switching to explicit time integration. Applies only when automatic implicit-explicit switching is active. The default is one attempt. If IAUTO=0, any input value is reset to unity.
KCYCLE	Number of explicit cycles to run in explicit mode before returning to the implicit mode. The actual time interval that is used will be the maximum between DTEXP and KCYCLE*(latest estimate of the explicit time step size).

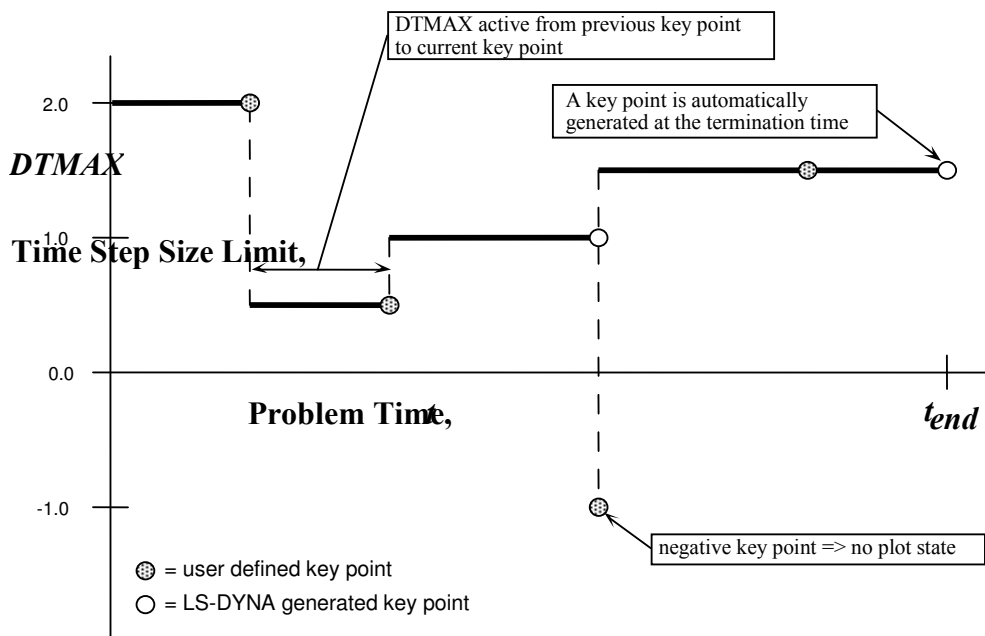


**Figure 11.8.** Iteration Window as defined by ITEOPT and ITEWIN.





**Figure 11.9.** The implicit time step size changes continuously as a function of convergence within the bounds set by DTMIN and DTMAX.



**Figure 11.10.** A key point curve can be identified using a negative value for DTMAX. Function values of each curve point give DTMAX. Time values are reached exactly by the automatic step controller, and a plot state is output unless DTMAX is negative.

**Remarks:**

- IAUTO            The default for IAUTO depends on the analysis type. For “springback” analysis, automatic time step control and artificial stabilization are activated by default.
  
- ITEOPT           With IAUTO=1, the time step size is adjusted if convergence is reached in a number of iterations that falls outside the specified ‘iteration window’, increasing after “easy” steps, and decreasing after “difficult” but successful steps. ITEOPT defines the midpoint of the iteration window. A value of ITEOPT=30 or more can be more efficient for highly nonlinear simulations by allowing more iterations in each step, hence fewer total steps.
  
- ITEWIN           The step size is not adjusted if the iteration count falls within ITEWIN of ITEOPT. Large values of ITEWIN make the controller more tolerant of variations in iteration count.
  
- DTMAX           To strike a particular simulation time exactly, create a key point curve (Figure 11.10) and enter DTMAX = -(curve ID). This is useful to guarantee that important simulation times, such as when peak load values occur, are reached exactly.
  
- DTEXP           When the automatic implicit-explicit switching option is activated (IMFLAG = 4 or 5 on \*CONTROL\_IMPLICIT\_GENERAL), the solution method will begin as

implicit, and if convergence of the equilibrium iterations fails, automatically switch to explicit for a time interval of DTEXP. A small value of DTEXP should be chosen so that significant dynamic effects do not develop during the explicit phase, since these can make recovery of nonlinear equilibrium difficult during the next implicit time step. A reasonable starting value of DTEXP may equal several hundred explicit time steps.

**\*CONTROL\_IMPLICIT\_BUCKLE**

Purpose: Activate implicit buckling analysis when termination time is reached (see also \*CONTROL\_IMPLICIT\_GENERAL).

Card            1            2            3            4            5            6            7            8

Variable	NMODE							
Type	I							
Default	0							

**VARIABLE****DESCRIPTION**

NMODE            Number of buckling modes to compute  
EQ.0: none (DEFAULT)  
EQ.n: compute n lowest buckling modes

**Remarks:**

Buckling analysis is performed at the end of a static implicit simulation. The simulation may be linear or nonlinear. After loads have been applied to the model, the buckling eigenproblem is solved:

$$[\mathbf{K}_M + \lambda \mathbf{K}_G] \{u\} = 0$$

where  $\mathbf{K}_M$  is the material tangent stiffness matrix, and the geometric or initial stress stiffness matrix  $\mathbf{K}_G$  is a function of internal stress in the model. The lowest n eigenvalues and eigenvectors are computed. The eigenvalues, written to text file “eigout”, represent multipliers to the applied loads which give buckling loads. The eigenvectors, written to binary database “d3eigv”, represent buckling mode shapes. View and animate these modes using LS-PrePost.

The geometric stiffness terms needed for buckling analysis will be automatically computed when the termination time is reached, regardless of the value of the geometric stiffness flag IGS on \*CONTROL\_IMPLICIT\_GENERAL.

A double precision executable should be used for best accuracy in buckling analysis.

**\*CONTROL\_IMPLICIT\_CONSISTENT\_MASS**

Purpose: Use the consistent mass matrix in implicit dynamics and eigenvalue solutions.

Card            1            2            3            4            5            6            7            8

Variable	IFLAG							
Type	I							
Default	0							

**VARIABLE**

**DESCRIPTION**

IFLAG

Consistent mass matrix flag

EQ.0: Use the standard lumped mass formulation (DEFAULT)

EQ.1: Use the consistent mass matrix.

**Remarks:**

The consistent mass matrix formulation is currently available for the three and four node shell elements, solid elements types 1, 2, 10, 15, 16, and 18 (See \*SECTION\_SOLID), and beam types 1, 2, 3, 4, and 5 (See \*SECTION\_BEAM). All other element types continue to use a lumped mass matrix.

**\*CONTROL\_IMPLICIT\_DYNAMICS**

Purpose: Activate implicit dynamic analysis and define time integration constants (see also \*CONTROL\_IMPLICIT\_GENERAL).

Card            1            2            3            4            5            6            7            8

Variable	IMASS	GAMMA	BETA	TDYBIR	TDYDTH	TDYBUR	IRATE	
Type	I	F	F	F	F	F	I	
Default	0	.50	.25	0.0	1.E+28	1.E+28	0	

**VARIABLE****DESCRIPTION**

IMASS	Implicit analysis type EQ.0: static analysis EQ.1: dynamic analysis using Newmark time integration. EQ.2: dynamic analysis by modal superposition following the solution of the eigenvalue problem EQ.3: dynamic analysis by modal superposition using the eigenvalue solution in the d3eigv files that are in the runtime directory.
GAMMA	Newmark time integration constant (see remarks below.)
BETA	Newmark time integration constant.
TDYBIR	Birth time for application of dynamic terms. See Figure 11.11. LT.0: curve ID = (-SCALE) used to control amount of implicit dynamic effects applied to the analysis
TDYDTH	Death time for application of dynamic terms.
TDYBUR	Burial time for application of dynamic terms.
IRATE	Rate effects switch: EQ.0: rate effects are on in constitutive models EQ.1: rate effects are off in constitutive models

**Remarks:**

For the dynamic problem, the linearized equilibrium equations may be written in the form

$$M\ddot{u}^{n+1} + D\dot{u}^{n+1} + K_t(x^n)\Delta u = P(x^n)^{n+1} - F(x^n)$$

where

$M$  = lumped mass matrix

$D$  = damping matrix

$u^{n+1} = x^{n+1} - x^0$  = nodal displacement vector

$\dot{u}^{n+1}$  = nodal point velocities at time n+1

$\ddot{u}^{n+1}$  = nodal point accelerations at time n+1.

Between the birth and death times 100% of the dynamic terms, that is the terms involving  $M$  and  $D$ , are applied. Between the death and burial time the dynamic terms are decreased linearly with respect to time until 0% of the dynamic terms are applied after the burial time. This feature is useful for problems that are initially singular because the parts are not in contact initially such as in metal stamping. For these problems dynamics is required for stable convergence. When contact is established the problem becomes well conditioned and the dynamic terms are no longer required for stable convergence. It is recommend that for such problems the user set the death time to be after contact is established and the burial time for 2 or 3 time steps after the death time.

For problems with more extensive loading and unloading patterns the user can control the amount of dynamic effects added to the model by using a load curve, see TDYBTH. This curve should have ordinate values between 0.0 and 1.0. The user should use caution in ramping the load curve and the associated dynamic effects from 1.0 to 0.0. Such a ramping down should take place over 2 or 3 implicit time steps.

The time integration is by the unconditionally stable, one-step, Newmark- $\beta$  time integration scheme

$$\ddot{u}^{n+1} = \frac{\Delta u}{\beta \Delta t^2} - \frac{\dot{u}^n}{\beta \Delta t} - \frac{1}{\beta} \left( \frac{1}{2} - \beta \right) \ddot{u}^n$$

$$\dot{u}^{n+1} = \dot{u}^n + \Delta t (1 - \gamma) \ddot{u}^n + \gamma \Delta t \ddot{u}^{n+1}$$

$$x^{n+1} = x^n + \Delta u$$

Here,  $\Delta t$  is the time step size, and  $\beta$  and  $\gamma$  are the free parameters of integration. For  $\gamma = \frac{1}{2}$

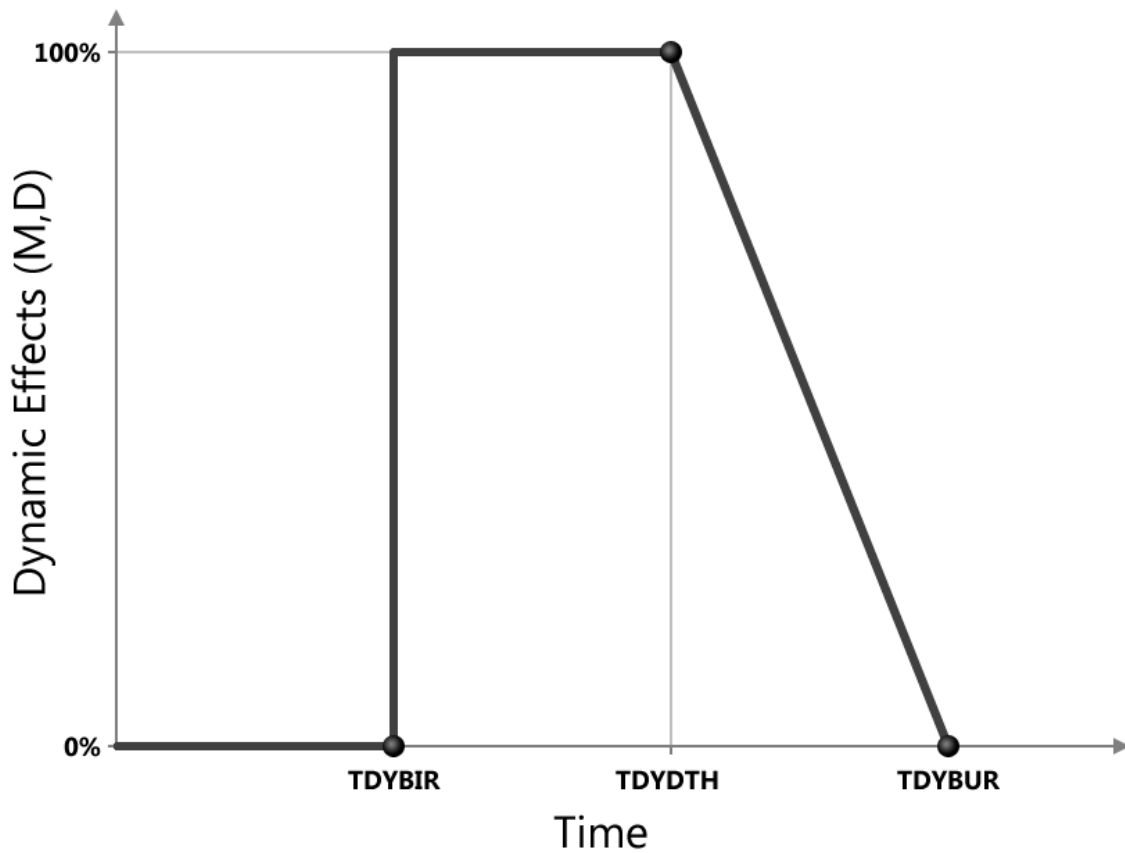
and  $\beta = \frac{1}{4}$  the method reduces to the trapezoidal rule and is energy conserving. If

$$\gamma > \frac{1}{2}$$

$$\beta > \frac{1}{4} \left( \frac{1}{2} + \gamma \right)^2$$

numerical damping is induced into the solution leading to a loss of energy and momentum.

When modal superposition is invoked, NEIGV on \*CONTROL\_IMPLICIT\_EIGENVALUE indicates the number of modes to be used. With modal superposition, stresses are computed only for linear shell formulation 18.



**Figure 11.11.** Birth, death, and burial time for implicit dynamics.



**\*CONTROL\_IMPLICIT\_EIGENVALUE**

Purpose: Activate implicit eigenvalue analysis and define associated input parameters (see also \*CONTROL\_IMPLICIT\_GENERAL).

Card            1            2            3            4            5            6            7            8

Variable	NEIG	CENTER	LFLAG	LFTEND	RFLAG	RHTEND	EIGMTH	SHFSC
Type	I	F	I	F	I	F	I	F
Default	0	0.0	0	-infinity	0	+infinity	2	0.0

**Optional Card 2**

Card            1            2            3            4            5            6            7            8

Variable	ISOLID	IBEAM	ISHELL	ITSHELL	MSTRES	EVDUMP		
Type	I	I	I	I	I	I		
Default	0	0	0	0	0	0		

<u>VARIABLE</u>	<u>DESCRIPTION</u>
NEIG	Number of eigenvalues to extract. This must be specified. The other parameters below are optional. LT.0: curve ID = (-NEIG) used for intermittent eigenvalue analysis
CENTER	Center frequency. This option finds the nearest NEIG eigenvalues located about this value.
LFLAG	Left end point finite flag. EQ.0: left end point is -infinity EQ.1: left end point is LFTEND.
LFTEND	Left end point of interval. Only used when LFLAG = 1.

<b>VARIABLE</b>	<b>DESCRIPTION</b>
RFLAG	Right end point finite flag: EQ.0: right end point is +infinity EQ.1: right end point is RHTEND.
RHTEND	Right end point of interval. Only used when RFLAG = 1.
EIGMTH	Eigenvalue extraction method: EQ.2: Block Shift and Invert Lanczos (default). EQ.3: Lanczos with [M] = [I] (for debug only). EQ.5: Same as 3 but include Dynamic Terms
SHFSCL	Shift scale. Generally not used, but see explanation below.
ISOLID	If nonzero, reset all solid element formulations to ISOLID for the implicit computations. Can be used for all implicit computations not just eigenvalue computations.
IBEAM	If nonzero, reset all beam element formulations to IBEAM for the implicit computations. Can be used for all implicit computations not just eigenvalue computations.
ISHELL	If nonzero, reset all shell element formulations to ISHELL for the implicit computations. Can be used for all implicit computations not just eigenvalue computations.
ITSHELL	If nonzero, reset all thick shell element formulations to ITSHELL for the implicit computations. Can be used for all implicit computations not just eigenvalue computations.
MSTRES	Flag for computing the stresses for the eigenmodes: EQ.0: Do not compute the stresses. EQ.1: Compute the stresses.
EVDUMP	Flag for writing eigenvalues and eigenvectors to file Eigen_Vectors: EQ.0: Do not write eigenvalues and eigenvectors. GT.0: Write eigenvalues and eigenvectors using an ASCII format. LT.0: Write eigenvalues and eigenvectors using a binary format.

**Remarks:**

To perform an eigenvalue analysis, activate the implicit method by selecting IMFLAG=1 on \*CONTROL\_IMPLICIT\_GENERAL, and indicate a nonzero value for NEIG above. By default, the lowest NEIG eigenvalues will be found. If a nonzero center frequency is specified, the NEIG eigenvalues nearest to CENTER will be found.

When  $NEIG > 0$ , eigenvalues will be computed at time=0 and LS-DYNA will terminate.

When  $NEIG < 0$ , an intermittent eigenvalue analysis will be performed. This is a transient simulation during which loads are applied, with eigenvalues computed periodically during the simulation. Changes in geometry, stress, material, and contact conditions will affect the eigenvalues. The transient simulation can be either implicit or explicit according to  $IMFLAG=1$  or  $IMFLAG=6$ , respectively, on **\*CONTROL\_IMPLICIT\_GENERAL**. The curve ID =  $-NEIG$  indicates when to extract eigenvalues, and how many to extract. Define one curve point at each desired extraction time, with a function value equal to the number of eigenvalues desired at that time. A d3plot database will be produced for the transient solution results. Consecutively numbered d3eigv and eigout databases will be produced for each intermittent extraction. The extraction time is indicated in each database's analysis title.

The Block Shift and Invert Lanczos code is from BCSLIB-EXT, Boeing's Extreme Mathematical Library.

When using Block Shift and Invert Lanczos, the user can specify a semifinite or finite interval region in which to compute eigenvalues. Setting  $LFLAG = 1$  changes the left end point from  $-\infty$  to the value specified by  $LFTEND$ . Setting  $RFLAG = 1$  changes the right end point from  $+\infty$  to the values given by  $RHTEND$ . If the interval includes  $CENTER$  (default value of 0.0) then the problem is to compute the  $NEIG$  eigenvalues nearest to  $CENTER$ . If the interval does not include  $CENTER$ , the problem is to compute the smallest in magnitude  $NEIG$  eigenvalues.

If all of the eigenvalues are desired in an interval where both end points are finite just input a large number for  $NEIG$ . The software will automatically compute the number of eigenvalues in the interval and lower  $NEIG$  to that value. The most general problem specification is to compute  $NEIG$  eigenvalues nearest  $CENTER$  in the interval  $[LFTEND, RHTEND]$ . Computing the lowest  $NEIG$  eigenvalues is equivalent to computing the  $NEIG$  eigenvalues nearest 0.0.

For some problems it is useful to override the internal heuristic for picking a starting point for Lanczos shift strategy, that is the initial shift. In these rare cases, the user may specify the initial shift via the parameter  $SHFSCL$ .  $SHFSCL$  should be in the range of first few nonzero frequencies.

Eigenvectors are written to an auxiliary binary plot database named "d3eigv", which is automatically created. These can be viewed using a postprocessor in the same way as a standard "d3plot" database. The time value associated with each eigenvector plot is the corresponding circular frequency. A summary table of eigenvalue results is printed to the "eigout" file. In addition to the eigenvalue results, modal participation factors and modal effective mass tables are written to the "eigout" file. The user can export individual eigenvectors using  $LSPrePost$ .

The strains associated with the stresses computed using the  $MSTRES$  option can be obtained by setting the  $STRFLG$  on **\*DATABASE\_EXTENT\_BINARY**.

Eigenvalues and eigenvectors can be written to file `Eigen_Vectors` by using a nonzero value for  $EVDUMP$ . If  $EVDUMP > 0$  an ASCII file is used. If  $EVDUMP < 0$  a simple binary format is

used. The binary format is to reduce file space. The eigenvectors written to this file will be orthonormal with respect to the mass matrix.

The print control parameter, LPRINT, and ordering method parameter, ORDER, from the \*CONTROL\_IMPLICIT\_SOLVER keyword card also apply to the Block Shift and Invert Eigensolver.

**\*CONTROL\_IMPLICIT\_FORMING**

Purpose: This keyword is used to perform implicit static analysis, especially for metal forming processes, such as gravity loading, binder closing, flanging, and stamping subassembly simulation. A systematic study had been conducted to identify the key factors affecting implicit convergence, and the preferred values are automatically set with this keyword. In addition to forming application, this keyword can also be used in other applications, such as dummy loading and roof crush, etc.

Card                    1                    2                    3                    4                    5                    6                    7                    8

Variable	IOPTION	NSMIN	NSMAX	BIRTH	DEATH	PENCHK		
Type	I	I	I	F	F	F		
Default	1	none	2	0.0	1.e+20	0.0		

**VARIABLE****DESCRIPTION**

IOPTION	Solution type: EQ.1: Gravity loading simulation, see remarks below. EQ.2: Binder closing and flanging simulation, see remarks below.
NSMIN	Minimum number of implicit steps for IOPTION=2.
NSMAX	Maximum number of implicit steps for IOPTION=2.
BIRTH	Birth time to activate this feature.
DEATH	Death time.
PENCHK	Relative allowed penetration with respect to the part thickness in contact for IOPTION=2.

**Remarks:**

1. This keyword provides a simplified interface for implicit static analysis. If no other implicit cards are used, the stiffness matrix is reformed for every iteration. Convergence tolerances (DCTOL, ECTOL, etc.) are automatically set and not recommended to be changed. In almost all cases, only two additional implicit control cards (\*CONTROL\_IMPLICIT\_GENERAL, and \_AUTO) may be needed to control the stepping size. Step size control is handled with the variable DT0, DTMIN and DTMAX.

2. As always, the variable IGAP should be set to “2” in \*CONTACT\_FORMING... cards for a more realistic contact simulation in forming. The contact type \*CONTACT\_FORMING\_SURFACE\_TO\_SURFACE is recommended to be used with implicit analysis. A smaller penalty stiffness scale factor SLSFAC produces faster results, so is recommended for gravity and closing simulation, where subsequent forming process is likely to follow and the extent of contact penetration will be reestablished there.
3. It is recommended that fully integrated element type 16 is to be used for all implicit calculation. For solids, type “-2” is recommended. Executable with double precision is to be used for all implicit calculation. Models with over 100,000 deformable elements are more efficient to be simulated with MPP for faster turnaround time.
4. An example of the implicit gravity is provided below, where a blank is loaded with gravity into a toggle die. A total of five steps are used, controlled by the variable DT0.

The implicit gravity application for both air and toggle draw process is available through LS-PrePost 3.2 in Metal Forming Application/eZ Setup.

```

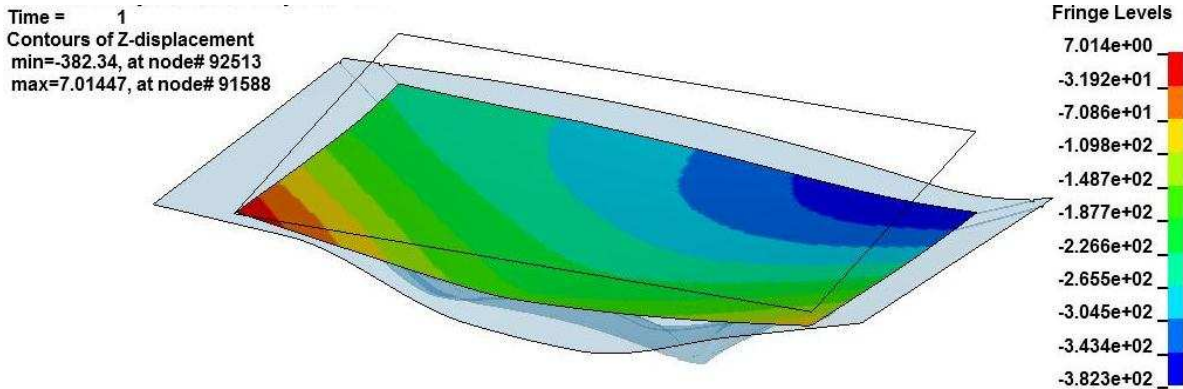
*KEYWORD
*PARAMETER
...
*CONTROL_TERMINATION
1.0
$-----1-----2-----3-----4-----5-----6-----7-----8
*CONTROL_IMPLICIT_FORMING
$ IOPTION
1
*CONTROL_IMPLICIT_GENERAL
$ IMFLAG DT0
1 0.2
$-----1-----2-----3-----4-----5-----6-----7-----8
*CONTROL_CONTACT
$ SLSFAC RWPNAL ISLCHK SHLTHK PENOPT THKCHG ORIEN
0.03 0.0 2 1 4 0 4
$ USRSTR USRFAC NSBCS INTERM XPENE SSTHK ECDT TIEDPRJ
0 0 10 0 1.0 0
$-----1-----2-----3-----4-----5-----6-----7-----8
*PART
Blank
&blkpid &blksec &blkmid
*SECTION_SHELL
$ SID ELFORM SHRF NIP PROPT QR/IRID ICOMP SETYP
&blksec 16 0.833 7 1.0
$ T1 T2 T3 T4 NLOC
&bthick,&bthick,&bthick,&bthick
$-----1-----2-----3-----4-----5-----6-----7-----8
*CONTACT_FORMING_SURFACE_TO_SURFACE
$ SSID MSID SSTYP MSTYP SBOXID MBOXID SPR MPR
&blkssid &lpunssid 2 2 1 1
$ FS FD DC VC VDC PENCHK BT DT
0.12 0.0 0.0 0.0 20.0 0 0.0 1E+20
$ SFS SFM SST MST SFST SFMT FSF VSF
1.0 1.0 0.0 &mstp
$ SOFT SOFSCL LCIDAB MAXPAR PENTOL DEPTH BSORT FRCFRQ
0
$ PENMAX THKOPT SHLTHK SNLOG ISYM I2D3D SLDTHK SLDSTF
1
$ IGAP IGNORE DPRFAC DTSTIF FLANGL
2
$-----1-----2-----3-----4-----5-----6-----7-----8
...

```

```

*LOAD_BODY_Z
90994
*DEFINE_CURVE_TITLE
Body Force on blank
90994
0.0,9810.0
10.0,9810.0
*LOAD_BODY_PARTS
&blksid
*LOAD_BODY_Z
90994
*END

```



Gravity Loading of a Box Side Outer (Courtesy of Autodie, LLC)

- An example of binder closing using implicit static is provided below using the NUMISHEET'05 decklid inner, where a blank is being closed in a toggle die (modified). An adaptive level of three was used in the closing process. Gravity is frequently applied at the same time, regardless if a prior gravity loading simulation is performed or not, as shown at the end of the input deck. This helps the blank establish an initial contact with the tool, thus improving the convergence. The upper binder is moved down by a closing distance (defined by a parameter &bindmv) using a displacement boundary condition (VAD=2), with a simple linearly increased triangle-shaped load curve. The variable DT0 is set at 0.01, determined by the expected total deformation. The solver will automatically adjust based on the initial contact condition. The maximum step size is controlled by the variable DTMAX, and it needs to be sufficiently small (0.03) to avoid missing contact, but yet not too small causing a long running time. In some cases, this variable can be set larger, but the current value works for most cases.

```

*KEYWORD
*PARAMETER
...
*CONTROL_TERMINATION
1.0
*CONTROL_IMPLICIT_FORMING
$ IOPTION NSMIN NSMAX
2 2 100
*CONTROL_IMPLICIT_GENERAL
$ IMFLAG DT0
1 0.01
*CONTROL_IMPLICIT_AUTO
$ IAUTO ITEOPT ITEWIN DTMIN DTMAX
0 0 0 0.01 0.03

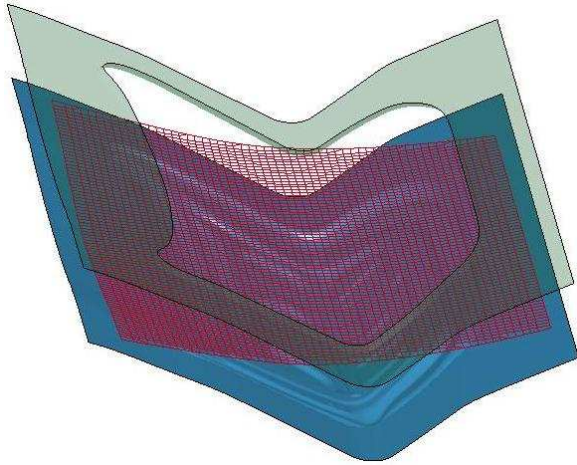
```

# \*CONTROL

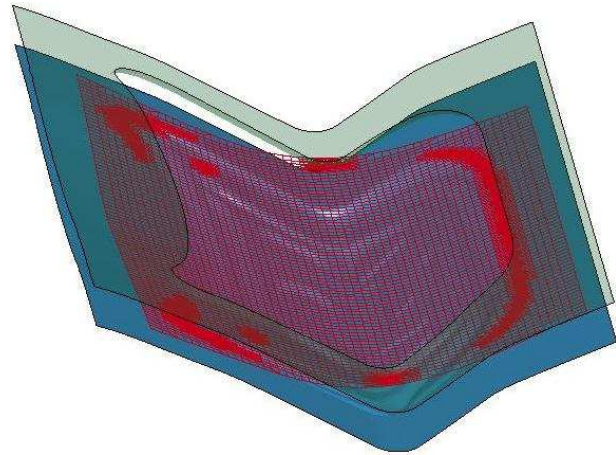
# \*CONTROL\_IMPLICIT\_FORMING

```
*CONTROL_ADAPTIVE
...
*CONTROL_CONTACT
$  SLSFAC  RWPNAL  ISLCHK  SHLTHK  PENOPT  THKCHG  ORIEN
   0.03    0.0    2        1        4        0        4
$  USRSTR  USRFAC  NSBCS   INTERM  XPENE   SSTHK   ECDT   TIEDPRJ
   0        0    10       0        1.0     0
$-----1-----2-----3-----4-----5-----6-----7-----8
...
*PART
Blank
$  PID      SECID      MID      EOSID      HGID      GRAV      ADPOPT      TMID
   &blkpid  &blksec  &blkmid
*SECTION_SHELL
$  SID      ELFORM      SHRF      NIP      PROPT  QR/IRID      ICOMP      SETYP
&blksec    16      0.833    7        1.0
$  T1      T2      T3      T4      NLOC
&bthick,&bthick,&bthick,&bthick
...
*CONTACT_FORMING_SURFACE_TO_SURFACE
$  SSID      MSID      SSTYP      MSTYP      SBOXID  MBOXID      SPR      MPR
   &blkssid  &lpunsid  2        2
$  FS      FD      DC      VC      VDC      PENCHK      BT      DT
   0.12    0.0    0.0    0.0    20.0    0        0.0    1E+20
$  SFS      SFM      SST      MST      SFST      SFMT      FSF      VSF
   1.0    1.0    0.0    &mstp
$  SOFT    SOFSCL  LCIDAB  MAXPAR  PENTOL  DEPTH      BSORT      FRCFRQ
   0
$  PENMAX  THKOPT  SHLTHK  SNLOG   ISYM    I2D3D     SLDTHK    SLDSTF
   1
$  IGAP    IGNORE  DPRFAC  DTSTIF      FLANGL
   2
*CONTACT_...
$-----1-----2-----3-----4-----5-----6-----7-----8
*BOUNDARY_PRESCRIBED_MOTION_RIGID
$  typeID  DOF      VAD      LCID      SF      VID      DEATH      BIRTH
&bindpid  3        2        3        -1.0    0
*DEFINE_CURVE
3
0.0,0.0
1.0,&bindmv
$-----1-----2-----3-----4-----5-----6-----7-----8
$ Activate gravity on blank:
*LOAD_BODY_Z
90994
*DEFINE_CURVE_TITLE
Body Force on blank
90994
0.0,9810.0
10.0,9810.0
*LOAD_BODY_PARTS
&blkssid
*END
```

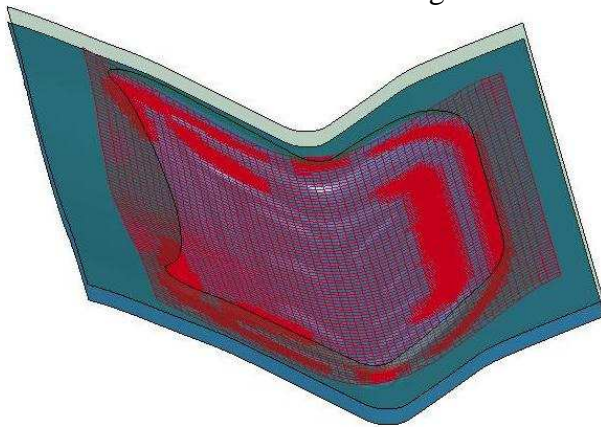




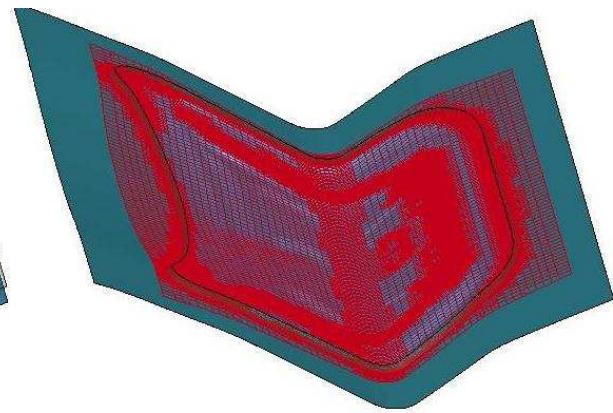
Initial Positioning



50% Upper Travel



80% Upper Travel

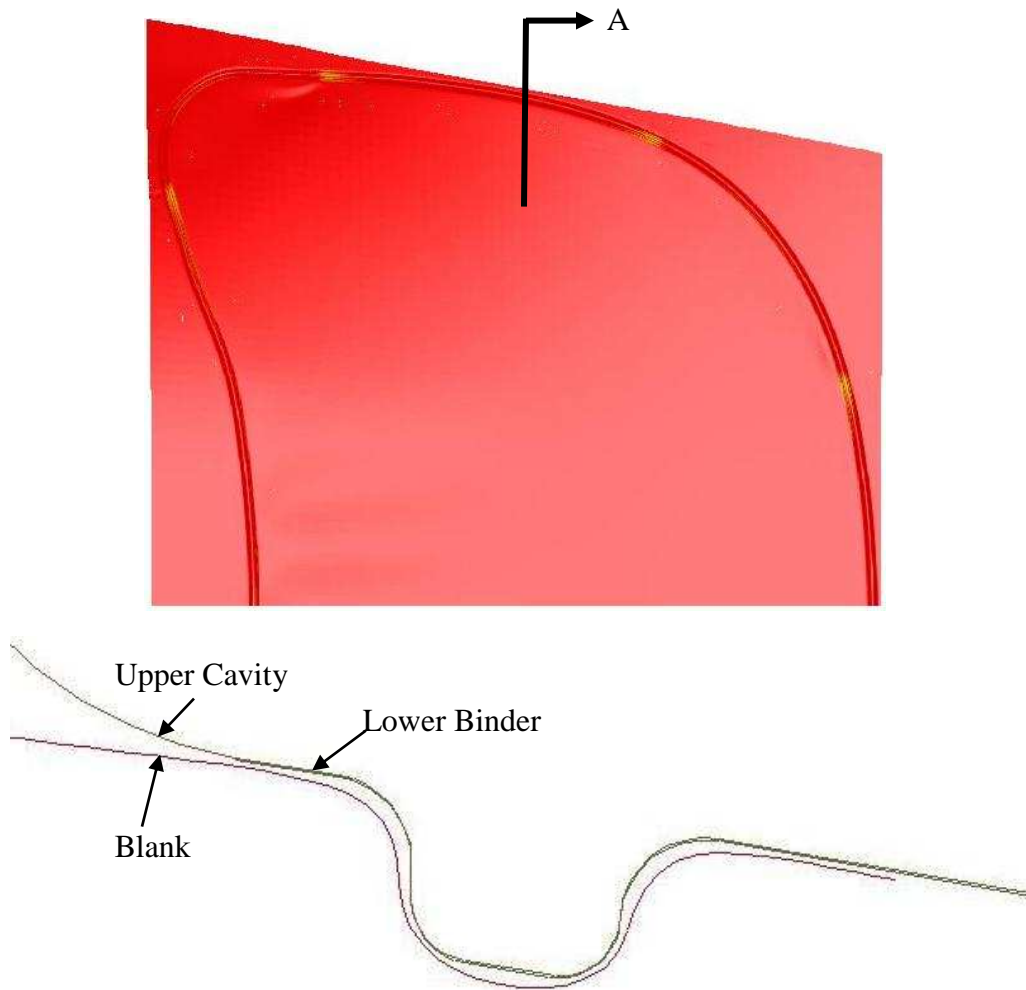


Upper Home



*Binder closing with adaptive refinement on a decklid inner (NNUMISHEET'05)*

Binder closing with real beads can also be done with implicit static, and with adaptive mesh. An example is show below.



Closing with beads (Lower Binder with Contact Offset of 2.2mm)

The implicit static closing can be set up in LS-PrePost v3.2 Metal Forming Application/eZ Setup.

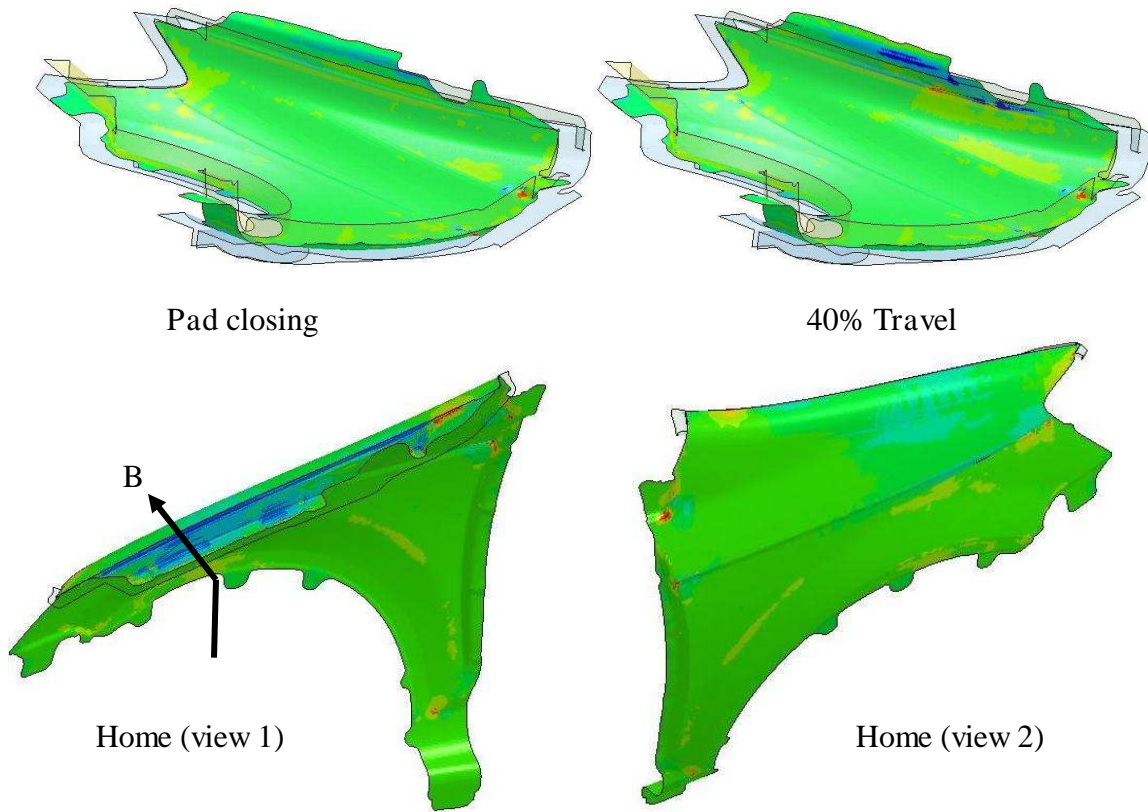
- An example of flanging simulation using this feature is show below, with NUMISHEET'02 fender outer, where flanging is conducted along the hood line. A partial input is provided below, where DTMAX is controlled by a load curve for contact and speed. The use of DTMAX with a load curve is an exception to the rule, where most of the time this is not needed. Smaller step sizes are better in some cases than larger step sizes, which may take longer to converge resulting in cutbacks in step sizes. Gravity, pad closing and flanging were set to 10%, 10% and 80% of the total step size, respectively. Pad travels '&padtrav' starting at 0.1, when it is to be automatically moved to close the gap with the blank due to gravity loading (\*CONTACT\_AUTO\_MOVE), and finishing at 0.2 and held in that position until the end. Flanging steel travels '&flgtrav' starting at 0.2 and completing at 1.0.

```

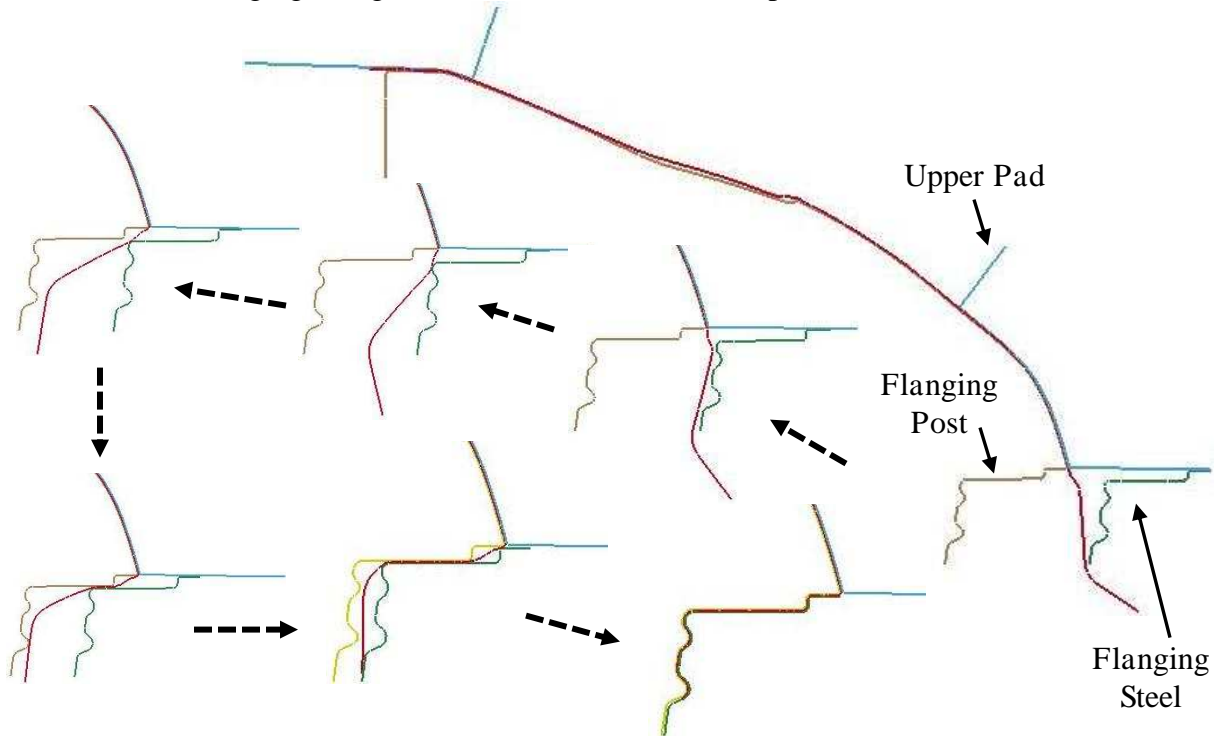
*KEYWORD
*PARAMETER ...
*CONTROL_TERMINATION
1.0
*CONTROL_IMPLICIT_FORMING
$ IOPTION      NSMIN      NSMAX
      2          2          200
*CONTROL_IMPLICIT_GENERAL
      1          0.100
*CONTROL_IMPLICIT_AUTO
$   IAUTO      ITEOPT      ITEWIN      DTMIN      DTMAX
      0          0          0          0.005      -9980
*DEFINE_CURVE
9980
0.0,0.1
0.1,0.1
0.2,0.1
0.7,0.005
1.0,0.005
*CONTROL_ADAPTIVE...
*CONTROL_CONTACT...
*PART...
*SECTION_SHELL...
*CONTACT_...
*CONTACT_FORMING_SURFACE_TO_SURFACE_ID_MPP
2
0,200,,3,2,1.005
$   SSID      MSID      SSTYP      MSTYP      SBOXID      MBOXID      SPR      MPR
    &blksid   &padsid      2          2
$   FS        FD        DC        VC        VDC        PENCHK      BT        DT
      0.12     0.0      0.0      0.0      20.0      0          0.0      1E+20
$   SFS      SFM      SST      MST      SFST      SFMT      FSF      VSF
      1.0     1.0      0.0      &mstp
$   SOFT     SOFSCS  LCIDAB  MAXPAR  PENTOL  DEPTH  BSORT  FRCFRQ
      0
$   PENMAX  THKOPT  SHLTHK  SNLOG  ISYM  I2D3D  SLDTHK  SLDSTF
      1
$   IGAP    IGNORE  DPRFAC  DTSTIF          FLANGL
      2
*BOUNDARY_PRESCRIBED_MOTION_RIGID
$   typeID    DOF      VAD      LCID      SF      VID      DEATH      BIRTH
    &padpid    3        2        3        -1.0    0
    &flgpid    3        2        4        -1.0    0
*DEFINE_CURVE
3
0.0,0.0
0.1,0.0
0.2,&padtrav
1.0,&padtrav
*DEFINE_CURVE
4
0.0,0.0
0.2,0.0
1.0,&flgtrav
$ Activate gravity on blank:
*LOAD_BODY_PARTS
&blksid
*LOAD_BODY_Z
90994
*DEFINE_CURVE_TITLE
Body Force on blank
90994
0.0,9810.0
10.0,9810.0
*CONTACT_AUTO_MOVE
$   ID      ContID      VID      LCID      ATIME
      -1     2          89      3          0.1
*END

```





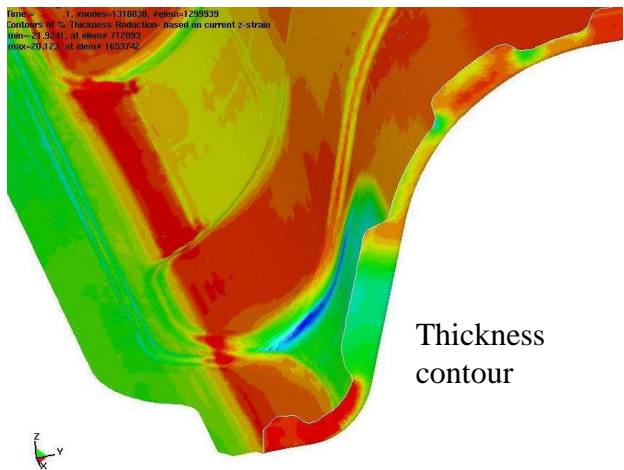
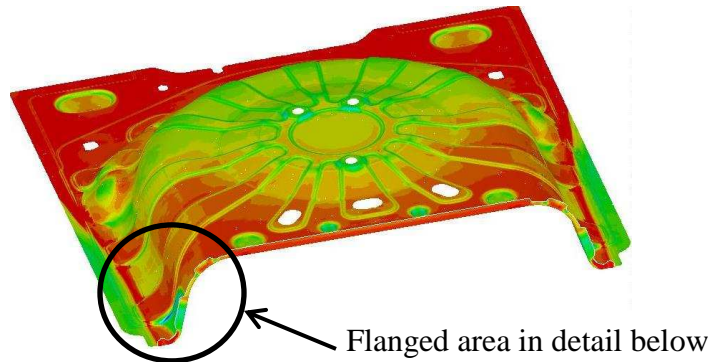
Fender flanging along hood line – mean stress (compression/surface lows in red)



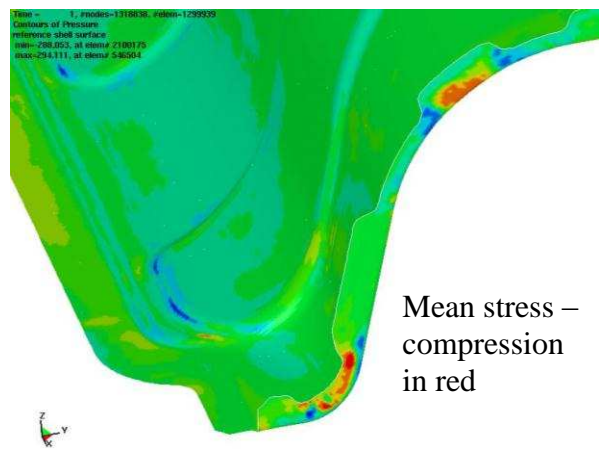
Deformed shape along section B

- 7. IOPTOIN 1 can also be used for closing and flanging simulation, or other applications that go through large plastic strains or deformation. This is used when an equal step size throughout the simulation is desired, and is done by specifying the equal step size in the variable DT0 in \*CONTROL\_IMPLICIT\_GENERAL, as shown in the following keywords (other cards similar and not included), where DT0 of 0.014 is chosen.

```
*CONTROL_IMPLICIT_FORMING
$ IOPTION
    1
*CONTROL_IMPLICIT_GENERAL
$ IMFLAG      DT0
    1          0.014
```



Thickness contour



Mean stress – compression in red

A flanging simulation of a rear floor pan using IOPTION 1 (Courtesy of Chrysler, LLC)

- 8. This implicit capability is available in R5.0 and later releases. Multi-step gravity loading simulation is recommended in R6 Rev64802 and later releases, and it is frequently used together with the blank pre-bending feature (\*CONTROL\_FORMING\_PRE\_BENDING) in R6 Rev66094 and later releases. Another related keyword also includes \*CONTACT\_AUTO\_MOVE, where the distance between the tool and blank can be automatically removed in a combined gravity and closing simulation in implicit static.

# \*CONTROL

# \*CONTROL\_IMPLICIT\_GENERAL

## \*CONTROL\_IMPLICIT\_GENERAL

Purpose: Activate implicit analysis and define associated control parameters. This keyword is required for all implicit analyses.

Card            1            2            3            4            5            6            7            8

Variable	IMFLAG	DT0	IMFORM	NSBS	IGS	CNSTN	FORM	ZERO_V
Type	I	F	I	I	I	I	I	I
Default	0	none	2	1	2	0	0	0

### VARIABLE

### DESCRIPTION

IMFLAG	Implicit/Explicit analysis type flag EQ.0: explicit analysis EQ.1: implicit analysis EQ.2: explicit followed by implicit (activates “seamless” springback) EQ.4: implicit with automatic implicit-explicit switching EQ.5: implicit with automatic switching and mandatory implicit finish EQ.6: explicit with intermittent eigenvalue extraction EQ.-n: curve ID=n gives IMFLAG as a function of time.
DT0	Initial time step size for implicit analysis
IMFORM	Element formulation flag for “seamless” springback (IMFLAG=2 or *INTERFACE_SPRINGBACK_SEAMLESS) EQ.1: switch to fully integrated shell formulation for springback EQ.2: retain original element formulation (default)
NSBS	Number of implicit steps in “seamless” springback (IMFLAG=2 or *INTERFACE_SPRINGBACK_SEAMLESS)
IGS	Geometric (initial stress) stiffness flag EQ.1: include EQ.2: ignore
CNSTN	Indicator for consistent tangent stiffness (solid materials 3 & 115 only): EQ.0: do not use (default) EQ.1: use.

---

<u>VARIABLE</u>	<u>DESCRIPTION</u>
FORM	Fully integrated element formulation (IMFLAG=2 and IMFORM=1 only) EQ.0: type 16 EQ.1: type 6.
ZERO_V	Zero out the velocity before switching from explicit to implicit. EQ.0: The velocities are not zeroed out. EQ.1: The velocities are set to zero.

**Remarks:**

IMFLAG The default value 0 indicates a standard explicit analysis will be performed. Using value 1 causes an entirely implicit analysis to be performed. Value 2 is automatically activated when the keyword **\*INTERFACE\_SPRINGBACK\_SEAMLESS** is present, causing the analysis type to switch from explicit to implicit when the termination time is reached. Other nonzero values for IMFLAG can also be used with **\*INTERFACE\_SPRINGBACK\_SEAMLESS**. After this switch, the termination time is extended by  $NSBS*DT0$ , or reset to twice its original value if  $DT0=0.0$ . The implicit simulation then proceeds until the new termination time is reached. Contact interfaces are automatically disabled during the implicit phase of “seamless” springback analysis.

When the automatic implicit-explicit switching option is activated (IMFLAG=4 or 5), the solution method will begin as implicit. If convergence of the equilibrium iterations fails, the solution will automatically switch to explicit for a time interval of DTEXP (see **\*CONTROL\_IMPLICIT\_AUTO**). After this time interval, the solution method will switch back to implicit and attempt to proceed. The implicit simulation may be either static or dynamic. When this feature is used in a static implicit job, simulation time is no longer arbitrary, and must be chosen along with DTEXP in a realistic way to allow efficient execution of any explicit phases. Mass scaling may also be activated (see **\*CONTROL\_TIMESTEP**), and will apply only during the explicit phases of the calculation. In cases where much switching occurs, users must exercise caution to ensure that negligible dynamic effects are introduced by the explicit phases.

When IMFLAG=5, the final step of the simulation must be implicit. The termination time will be extended automatically as necessary, until a successfully converged implicit step can be obtained. This is useful for example in difficult metal forming springback simulations.

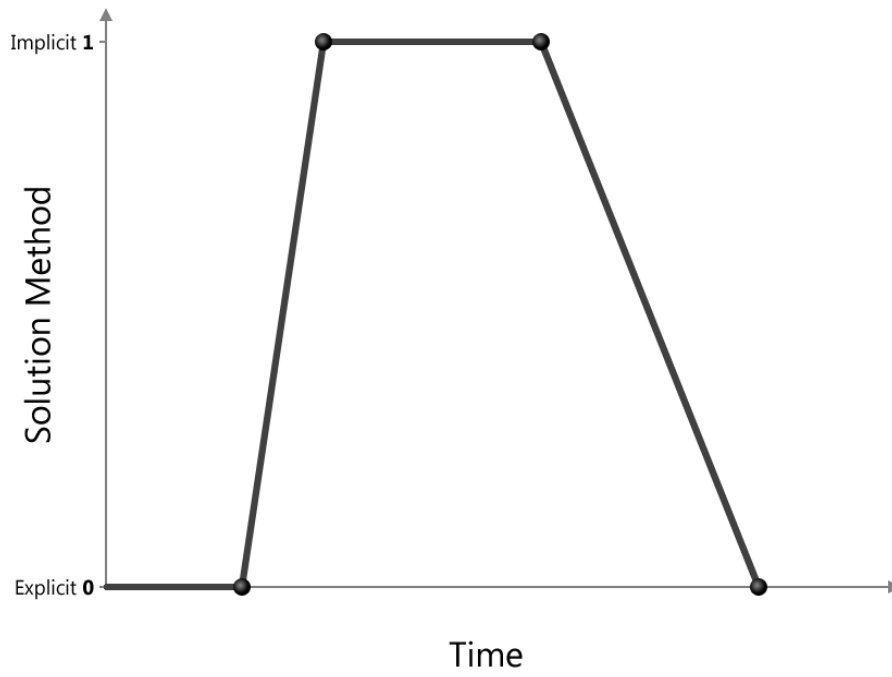
When IMFLAG=6, an explicit simulation will be performed. Eigenvalues will be extracted intermittently according to a curve indicated by NEIG=(-curve ID) on **\*CONTROL\_IMPLICIT\_EIGENVALUE**. Beware that dynamic stress

oscillations which may occur in the explicit simulation will influence the geometric (initial stress) stiffness terms used in the eigen solution, potentially producing misleading results and/or spurious modes. As an alternative, eigenvalues can also be extracted intermittently during an implicit analysis, using IMFLAG=1 and NEIG=(-curve ID).

When IMFLAG < 0, a curve ID is indicated which gives the solution method as a function of time. Define a curve value of zero during explicit phases, and a value of one during implicit phases. Use steeply sloping sections between phases. An arbitrary number of formulation switches may be activated with this method. See Figure 11.12.

- DT0      This parameter selects the initial time step size for the implicit phase of a simulation. The step size may change during a multiple step simulation if the automatic time step size control feature is active (see \*CONTROL\_IMPLICIT\_AUTO.)
- IMFORM    Adaptive mesh must be activated when using element formulation switching. For best springback accuracy, use of shell type 16 is recommended during the entire stamping and springback analysis, in spite of the increased cost of using this element during the explicit stamping phase.
- NSBS      The NSBS option allows a “seamless” springback analysis to use multiple unloading steps (\*CONTROL\_IMPLICIT\_STABILIZATION is also required in this case).
- IGS        The geometric stiffness adds the effect of initial stress to the global stiffness matrix. This effect is seen in a piano string whose natural frequency changes with tension. Geometric stiffness does not always improve nonlinear convergence, especially when compressive stresses are present, so its inclusion is optional. Furthermore, the geometric stiffness may lead to convergence problems with incompressible, or nearly incompressible, materials.





**Figure 11.12.** Solution method, implicit or explicit, controlled by a load curve.

# \*CONTROL

# \*CONTROL\_IMPLICIT\_INERTIA\_RELIEF

## \*CONTROL\_IMPLICIT\_INERTIA\_RELIEF

Purpose: Allows analysis of linear static problems that have rigid body modes.

Card            1            2            3            4            5            6            7            8

Variable	IRFLAG	THRESH						
Type	I	F						
Default	0	0.001						

### VARIABLE

### DESCRIPTION

IRFLAG

Inertia relief flag

EQ.0: do not perform inertia relief

EQ.1: do perform inertia relief

THRESH

Threshold for what is a rigid body mode. The default is set to 0.001 Hertz where it is assumed that the units are in seconds.

**\*CONTROL\_IMPLICIT\_JOINTS**

Purpose: Specify explicit or implicit treatment of joints for implicit analysis.

Card            1            2            3            4            5            6            7            8

Variable	ISPHER	IREVOL	ICYLIN					
Type	I	I	I					
Default	1	1	1					

<u>VARIABLE</u>	<u>DESCRIPTION</u>
ISPHER	Treatment of spherical joints EQ.1: use constraint method for all spherical joints (default) EQ.2: use penalty method for all spherical joints
IREVOL	Treatment of revolute joints EQ.1: use constraint method for all revolute joints (default) EQ.2: use penalty method for all revolute joints
ICYLIN	Treatment of cylindrical joints EQ.1: use constraint method for all cylindrical joints (default) EQ.2: use penalty method for all cylindrical joints

**Remarks:**

For most implicit applications one should use the constraint (default) method for the treatment of joints. When explicit-implicit switching is used the joint treatment should be consistent. This keyword allows the user to choose the appropriate treatment for their application.

# \*CONTROL

# \*CONTROL\_IMPLICIT\_MODES

## \*CONTROL\_IMPLICIT\_MODES\_{OPTION}

Available options include:

<BLANK>

### BINARY

Purpose: Request calculation of constraint, attachment, and/or eigenmodes for later use in modal analysis using \*PART\_MODES (see also \*CONTROL\_IMPLICIT\_GENERAL) or \*ELEMENT\_DIRECT\_MATRIX\_INPUT.

Card            1            2            3            4            5            6            7            8

Variable	NSIDC	NSIDA	NEIG	IBASE	SE_MASS	SE_DAMP	SE_STIFF	SE_INERT
Type	I	I	I	I	C	C	C	C
Default	0	0						

Card 2

Variable	SE_FILENAME
Type	C

<u>VARIABLE</u>	<u>DESCRIPTION</u>
NSIDC	Node set ID for constraint modes EQ.0: no constraint modes will be generated
NSIDA	Node set ID for attachment modes EQ.0: no attachment modes will be generated
NEIG	Number of eigenmodes EQ.0: no attachment modes will be generated
IBASE	Offset for numbering of the generalized internal degrees of freedom for the superelement

<u>VARIABLE</u>	<u>DESCRIPTION</u>
SE_MASS	Name of the superelement mass matrix. If left blank it is not generated.
SE_DAMP	Name of the superelement damping matrix. If left blank it is not generated.
SE_STIFF	Name of the superelement stiffness matrix. If left blank it is not generated.
SE_INERT	Name of the superelement inertia matrix, required for gravity loading applications of the superelement. If left blank it is not generated.
SE_FILENAME	If any of SE_MASS, SE_DAMP, SE_STIFF, or SE_INERT is blank then the second line is required and contains the file name for the superelement.

**Remarks:**

To use this feature, an implicit analysis must be requested using IMFLAG=1 on \*CONTROL\_IMPLICIT\_GENERAL, and a non-zero termination time must be specified on \*CONTROL\_TERMINATION. A double precision version of LS-DYNA should be used for best accuracy. Care must be taken to apply a sufficient number of constraints to the model to eliminate static rigid body motion. Computed modes are written to binary output file d3mode, which can be viewed using LS-PREPOST. Eigenmodes are also written to binary output file d3eigv.

Constraint and attachment modes are generated by applying unit displacements and unit forces, respectively, to each specified degree of freedom. By default, modes are computed for all degrees of freedom for each node in sets NSIDC and NSIDA. The first and second node set attribute parameters can be optionally used to restrict the translational and rotational degrees of freedom for which modes are requested, respectively, according to the following syntax:

Node set attribute parameters DA1 and A1: translational degree of freedom codes

Node set attribute parameters DA2 and A2: rotational degree of freedom codes

<u>code</u>	<u>modes computed</u>
0	(See note below.)
1	X degree of freedom only
2	Y degree of freedom only
3	Z degree of freedom only
4	X, Y degrees of freedom only
5	Y, Z degrees of freedom only
6	X, Z degrees of freedom only

## 7 X, Y, Z degrees of freedom

Setting both node set attributes to zero is equivalent to setting both node set attributes to 7 (X, Y, and Z for translational and rotational degrees of freedom).

If one node set attribute is nonzero (codes 1 to 7) and the other node set attribute is zero, then the zero attribute means NO degrees of freedom are considered. For example, if DA1=2 and DA2=0, then only the Y-translational degree of freedom modes are calculated.

Eigenmodes are generated for the model with single point constraints applied on the constraint modes. The number of eigenmodes is specified here. If the user wants to compute eigenmodes other than the lowest ones, the controls on \*CONTROL\_IMPLICIT\_EIGENVALUE can be used.

When the superelement is created an internal numbering must be applied to the attachment and eigen modes. This numbering starts at IBASE+1.

The user can create the superelement representation of the reduced model by specifying the SE\_MASS, SE\_DAMP, SE\_STIFF, SE\_INERT and SE\_FILENAME fields. The file, by default is written in the Nastran DMIG file format and can be used as input to \*ELEMENT\_DIRECT\_MATRIX\_INPUT. The keyword option \_BINARY can be used to create a binary representation for the superelement which can be used with \*ELEMENT\_DIRECT\_MATRIX\_INPUT\_BINARY to reduce the file size.

The combination of constraint modes and eigenmodes form the Hurty-Craig-Bampton linearization for a model. Using only constraint modes is the same as static condensation.

**\*CONTROL\_IMPLICIT\_SOLUTION****\*CONTROL****\*CONTROL\_IMPLICIT\_SOLUTION**

Purpose: These optional cards apply to implicit calculations. Use these cards to specify whether a linear or nonlinear solution is desired. Parameters are also available to control the implicit nonlinear and arc length solution methods (see also \*CONTROL\_IMPLICIT\_GENERAL).

Card 1            1            2            3            4            5            6            7            8

Variable	NSOLVR	ILIMIT	MAXREF	DCTOL	ECTOL	RCTOL	LSTOL	ABSTOL
Type	I	I	I	F	F	F	F	F
Default	2	11	15	0.001	0.01	1.0e+10	0.90	1.e-10

**Optional Card 2**

Card 2            1            2            3            4            5            6            7            8

Variable	DNORM	DIVERG	ISTIF	NLPRINT	NLNORM	D3ITCTL	CPCHK	
Type	I	I	I	I	I	I	I	
Default	2	1	1	0	2	0	0	

**Optional Card 3 (if card 3 is used, then card 2 above must also be used)**

Card 3            1            2            3            4            5            6            7            8

Variable	ARCCTL	ARCDIR	ARCLEN	ARCMTH	ARCDMP	ARCPSI	ARCALF	ARCTIM
Type	I	I	F	I	I	F	F	F
Default	0	none	0	1	2	0.	0.	0.

**Optional Card 4 (if card 4 is used, then cards 2 and 3 above must also be used)**

Card 4            1            2            3            4            5            6            7            8

Variable	LSMTD	LSDIR	IRAD	SRAD	AWGT	SRED		
Type	I	I	F	F	F	F		
Default	1	2	0.0	0.0	0.0	0.0		

**VARIABLE****DESCRIPTION**

NSOLVR	Solution method for implicit analysis: EQ.1: Linear EQ.2: Nonlinear with BFGS updates (default) EQ.3: Nonlinear with Broyden updates EQ.4: Nonlinear with DFP updates EQ.5: Nonlinear with Davidon updates EQ.6: Nonlinear with BFGS updates + arclength EQ.7: Nonlinear with Broyden updates + arclength EQ.8: Nonlinear with DFP updates + arclength EQ.9: Nonlinear with Davidon updates + arclength EQ.12: Experimental nonlinear with BFGS updates + optional arclength
ILIMIT	Iteration limit between automatic stiffness reformations
MAXREF	Stiffness reformation limit per time step
DCTOL	Displacement relative convergence tolerance
ECTOL	Energy relative convergence tolerance
RCTOL	Residual (force) relative convergence tolerance (DEFAULT=inactive)
LSTOL	Line search convergence tolerance
ABSTOL	Absolute convergence tolerance.
DNORM	Displacement norm for convergence test EQ.1: Increment vs. displacement over current step EQ.2: Increment vs. total displacement (default)



VARIABLE	DESCRIPTION								
DIVERG	Divergence flag (force imbalance increase during equilibrium iterations) EQ.1: reform stiffness if divergence detected (default) EQ.2: ignore divergence								
ISTIF	Initial stiffness formation flag EQ.1: reform stiffness at start of each step (default) EQ.n: reform stiffness at start of every "n"th step								
NLPRINT	Nonlinear solver print flag EQ.0: no nonlinear iteration information printed (new v970 default) EQ.1: print iteration information to screen, message, d3hsp files EQ.2: print extra norm information (NLNORM=1)  NOTE: during execution, interactive commands can be used: <table border="0"> <tr> <td><u>interactive command</u></td> <td><u>response</u></td> </tr> <tr> <td>&lt;ctrl-c&gt; <b>nlprint</b></td> <td>toggle NLPRINT between 0 and 1</td> </tr> <tr> <td>&lt;ctrl-c&gt; <b>diagnostic</b></td> <td>toggle NLPRINT between 0 and 2</td> </tr> <tr> <td>&lt;ctrl-c&gt; <b>information</b></td> <td>set NLPRINT=2 for one iteration</td> </tr> </table>	<u>interactive command</u>	<u>response</u>	<ctrl-c> <b>nlprint</b>	toggle NLPRINT between 0 and 1	<ctrl-c> <b>diagnostic</b>	toggle NLPRINT between 0 and 2	<ctrl-c> <b>information</b>	set NLPRINT=2 for one iteration
<u>interactive command</u>	<u>response</u>								
<ctrl-c> <b>nlprint</b>	toggle NLPRINT between 0 and 1								
<ctrl-c> <b>diagnostic</b>	toggle NLPRINT between 0 and 2								
<ctrl-c> <b>information</b>	set NLPRINT=2 for one iteration								
NLNORM	Nonlinear convergence norm type EQ.1: consider translational and rotational degrees of freedom EQ.2: consider translational degrees of freedom only (default)								
D3ITCTL	Control D3ITER database. If nonzero, the search directions for the nonlinear implicit solution are written to the D3ITER database. To reduce the size of the D3ITER database the database is reset every n time steps where n=D3ITCTL.								
CPCHK	Contact penetration check flag EQ.0: no contact penetration is performed (default) EQ.1: check for contact penetration during the nonlinear solution procedure. If such penetration is found modify the line search to prevent unnecessary penetration.								

The following 8 parameters are for use with arc length methods only ( $6 \leq NSOLVR \leq 9$  or  $NSOLVR=12$ ):

ARCCTL	Arc length controlling node ID EQ.0: generalized arc length method
ARCDIR	Arc length controlling node direction (ignored if ARCCTL=0 above) EQ.1: global X-translation EQ.2: global Y-translation EQ.3: global Z-translation

---

<b>VARIABLE</b>	<b>DESCRIPTION</b>
ARCLEN	Relative arc length size. See remarks below. LE.0.0: use automatic size, GT.0.0: use ARCLLEN*automatic step size.
ARCMTH	Arc length method EQ.1: Crisfield (default) EQ.2: Ramm EQ.3: Modified Crisfield (used with NSOLVR=12 only)
ARCDMP	Arc length damping option EQ.2: off (default) EQ.1: on, oscillations in static solution are suppressed
ARCPSI	Relative influence of load/time parameter in spherical arclength constraint, default value is 0 which corresponds to a cylindrical arclength constraint. Applies to ARCMTH=3.
ARCALF	Relative influence of predictor step direction for positioning of the arc center, default is 0 which means that the center is at the origin. Applies to ARCMTH=3.
ARCTIM	Optional time when arclength method is initiated. Applies to ARCMTH=3.
LSMTD	Line search convergence method: EQ.1: Energy method using only translational variables (default) EQ.2: Residual method EQ.3: Energy method using both translational and rotational variables
LSDIR	Line search direction method: EQ.1: Search on all variables (traditional approach used in versions prior to 971) EQ.2: Search only on the independent (unconstrained) variables EQ.3: Use adaptive line search (see AWGT, SRED) EQ.4: Use curved line search (see IRAD, SRAD)
IRAD	Normalized curvature factor for curved line search, where 0 indicates a straight line search and 1 indicates full curved line search.
SRAD	Radius of influence for determining curve in curved line search. For each independent node, all nodes within this radius are used for determining the curve. If 0, then all nodes connected to the same element as the independent node are used.

---

<u>VARIABLE</u>	<u>DESCRIPTION</u>
AWGT	Adaptive line search weight factor between 0 and 1. A high value tends to restrict the motion of oscillating nodes during the implicit process.
SRED	Initial step reduction between 0 and 1 for adaptive line search, use large number for conservative start in implicit procedure.

**Remarks:**

NSOLVR If a linear analysis is selected, equilibrium checking and iterations are not performed.

The Full Newton nonlinear solution method can be invoked by using the default BFGS solver, and selecting ILIMIT=1 to form a new stiffness matrix every iteration.

In the neighborhood of limit points the Newton based iteration schemes often fail. The arc length method of Riks and Wempner (combined here with the BFGS method) adds a constraint equation to limit the load step to a constant "arc length" in load-displacement space. This method is frequently used to solve snap through buckling problems. When applying the arc-length method, the curves that define the loading should contain only two points, and the first point should be at the origin (0,0). LS-DYNA will extrapolate, if necessary, to determine the load. In this way, time and load magnitude are related by a constant. It is possible that time can become negative in case of load reversal. The arc length method cannot be used in a dynamic analysis.

ILIMIT In the default BFGS method, the global stiffness matrix is only reformed every ILIMIT iterations. Otherwise, an inexpensive stiffness update is applied. By setting ILIMIT=1, a stiffness reformation is performed every iteration. This is equivalent to the Full Newton method (with line search). A higher value of ILIMIT (20-25) can reduce the number of stiffness matrix reformations and factorizations which may lead to a significant reduction in cost. Note that the storage requirements for implicit include storing 2 vectors per iteration. Large values of ILIMIT will cause substantial increase in storage requirements.

MAXREF The nonlinear equilibrium search will continue until the stiffness matrix has been reformed MAXREF times, with ILIMIT iterations between each reformation. If equilibrium has not been found, control will be passed to the automatic time step controller if it is activated. Otherwise, error termination will result. When the auto time step controller is active, it is often efficient to choose MAXREF=5 and try another stepsize quickly, rather than wasting too many iterations on a difficult step.

DCTOL	When the displacement norm ratio is reduced below DCTOL, this condition is satisfied. Smaller numbers lead to more accurate determination of equilibrium and, on the negative side, result in more iterations and higher costs. Use NLPRINT to display norm data each iteration.
ECTOL	When the energy norm ratio is reduced below ECTOL, this condition is satisfied. Smaller numbers lead to more strict determination of equilibrium and, on the negative side, result in more iterations and higher costs. Use NLPRINT to display norm data each iteration.
RCTOL	When the residual norm ratio is reduced below RCTOL, this condition is satisfied. Smaller numbers lead to more strict determination of equilibrium and, on the negative side, result in more iterations and higher costs. By default this convergence criterion is effectively disabled using RCTOL=1.e10. Use NLPRINT to display norm data each iteration.
LSTOL	A line search is performed on stiffening systems to guard against divergence of Newton-based nonlinear solvers. With the Full Newton method, it is sometimes helpful to define a large value (LSTOL=9999.0) to effectively disable line search.
DNORM	When computing the displacement ratio, the norm of the incremental displacement vector is divided by the norm of “total” displacement. This “total” displacement may be either the total over the current step, or the total over the entire simulation. The latter tends to be more lax, and can be poor at the end of simulations where large motions develop. For these problems, an effective combination is DNORM=1, and DCTOL=0.01 or larger.
DIVERG	By default, a new stiffness matrix is formed whenever divergence (growing out-of-balance force) is detected. This flag can be used to suppress this stiffness reformation.
ISTIF	By default, a new stiffness matrix is formed at the start of every time step. Suppressing this stiffness reformation can decrease the cost of simulations which have many tiny steps that are mostly linear, such as transient dynamics.
NLPRINT	This flag controls printing of displacement and energy convergence measures during the nonlinear equilibrium search. If convergence difficulty occurs, this information is helpful in determining the problem.
NLNORM	By default, only translational degrees of freedom are used in evaluating convergence norms. Use this flag to include rotational degrees of freedom, or to make additional data available for diagnosing convergence problems. This additional data includes the worst offending node and degree of freedom contributing to each norm.
ARCCTL	The arc length method can be controlled based on the displacement of a single node in the model. For example, in dome reversal problems the node at the center of the dome can be used. By default, the generalized arc length method is used,

where the norm of the global displacement vector controls the solution. This includes all nodes.

- ARCLEN In many cases the arc length method has difficulty tracking the load displacement curve through critical regions. Using  $0 < \text{ARCLEN} < 1$  will reduce the step size to assist tracking the load-displacement curve with more accuracy. Use of  $\text{ARCLEN} < 1$  will cause more steps to be taken. Suggested values are 1.0 (the default), 0.5, 0.25, and 0.10.
- ARCDMP Some static problems exhibit oscillatory response near instability points. This option numerically suppresses these oscillations, and may improve the convergence behavior of the post-buckling solution.
- LSMTD The default method for determining convergence of the nonlinear line search is to find the minimum of the energy. This parameter allows choosing the energy on only the translational variables, energy of both the translational and rotational variables, or for minimizing the residual (forces). The effect of using a residual based line search is not always positive, sometimes it is too restrictive and stops convergence. However, it is a more conservative approach than using the energy based method since it explicitly controls the norm of the residual. It should not be seen as a better strategy than the energy method but as an alternative to try in cases when the default method seems to be working poorly.
- LSDIR In Version 971 of LS-DYNA new line search options were added. The traditional approach ( $\text{LSDIR}=1$ ) computes the line search direction using all variables. The new (default) approach of  $\text{LSDIR}=2$  computes the line search direction only on the unconstrained variables. It has proven to be both robust and more efficient. We have also included two new approaches to try for problems where the default and traditional approach fail and the user is using Full Newton ( $\text{ILIMIT}=1$ ). See the next two remarks for more information on those methods.
- IRAD, SRAD The parameters IRAD and SRAD are for the curved line search ( $\text{LSDIR}=4$ ). The first parameter is a switch (0 or 1) to invoke this line search, an intermediate value is interpreted as weighted combination of a straight and curved line search (the curvature radius is decreased with increasing IRAD). A value of unit is recommended in situations with rather smooth responses, e.g. springback and similar problems. Also,  $\text{IRAD}=1$  seems to work best with full Newton iterations. The SRAD parameter should be equal to 0 for most cases, this means that the search curve for a node is determined from the search direction of nodes connected to the same elements as that node.  $\text{SRAD} > 0$  is interpreted as a radius of influence, meaning that the search curve for a node is determined from the search direction of nodes within a distance SRAD of this node. This option was introduced as an experiment to see if this had a smoothing and stabilizing effect. A value of 0.0 is currently recommended.
- AWGT, SRED The parameters AWGT and SRED are for the adaptive line search. The intention is to improve robustness for problems that have tendencies to oscillate or diverge,

indicated by the `dnorm` and `enorm` parameter outputs in the iterations (`stdout`). A value of 0.5 is recommended for `AWGT` as a starting point. With a nonzero value the motions of individual nodes are tracked. For nodes that are oscillating (going back and forth in space), the maximum step size for the next iteration is reduced in proportion to the parameter `AWGT`, and for nodes that are not oscillating but going nicely along a straight path, the maximum step size for the next iteration is increased in proportion to  $1 - \text{AWGT}$ . In test problems, the introduction of the adaptive line search has stabilized the implicit procedure in the sense that the `dnorm` and `enorm` values are more monotonically decreasing until convergence with virtually no oscillations. If a problem is still oscillating or diverging, the user should try to increase the `AWGT` parameter since this is a more restrictive approach but probably gives a slower convergence rate. An option for nasty problems is also to use `SRED`>0 which is the initial step reduction factor (less than 1). This means that the initial step size is reduced by this value but the maximum step size will increase by an amount that is determined by the success in the iterative procedure, eventually it will reach unity. It can never decrease. Also here, it is intended to be used with full Newton method.

**\*CONTROL\_IMPLICIT\_SOLVER**

Purpose: These optional cards apply to implicit calculations. The linear equation solver performs the CPU-intensive stiffness matrix inversion (see also \*CONTROL\_IMPLICIT\_GENERAL).

Card 1            1            2            3            4            5            6            7            8

Variable	LSOLVR	LPRINT	NEGEV	ORDER	DRCM	DRCPRM	AUTOSP C	AUTOTO L
Type	I	I	I	I	I	F	I	F
Default	4	0	2	0	1	see below	1	see below

**Optional Card 2**

Card 2            1            2            3            4            5            6            7            8

Variable	LCPACK	MTXDMP						
Type	I	I						
Default	2	0						

<u>VARIABLE</u>	<u>DESCRIPTION</u>
LSOLVR	Linear equation solver method EQ.4: SMP parallel multi-frontal sparse solver (default). EQ.5: SMP parallel multi-frontal sparse solver, double precision EQ.6: BCSLIB-EXT, direct, sparse, double precision EQ.10: iterative, best of currently available iterative methods EQ.11: iterative, Conjugate Gradient method EQ.12: iterative, CG with Jacobi preconditioner EQ.13: iterative, CG with Incomplete Choleski preconditioner EQ.14: iterative, Lanczos method EQ.15: iterative, Lanczos with Jacobi preconditioner EQ.16: iterative, Lanczos with Incomplete Choleski preconditioner

---

<b>VARIABLE</b>	<b>DESCRIPTION</b>
LPRINT	Linear solver print flag controls screen and message file output EQ.0: no printing EQ.1: output summary statistics on memory, cpu requirements EQ.2: more statistics EQ.3: even more statistics and debug checking (NOTE: during execution, use the interactive command "<ctrl-c> lprint" to toggle this print flag between 0 and 1.)
NEGEV	Negative eigenvalue flag. Selects procedure when negative eigenvalues are detected during stiffness matrix inversion. EQ.1: stop, or retry step if auto step control is active EQ.2: print warning message, try to continue (default)
ORDER	Ordering option EQ.0: method set automatically by LS-DYNA EQ.1: MMD, Multiple Minimum Degree. EQ.2: Metis
DRCM	Drilling rotation constraint method: EQ.1: add stiffness (old default in Version 970) EQ.2: add no stiffness EQ.3: add no stiffness EQ.4: add stiffness (new default in Version 971 Release 2)
DRCPRM	Drilling rotation constraint parameter, DRCPRM. If adding stiffness, DRCM=1, then, for linear problems, DRCPRM=1.0; for nonlinear problems, DRCPRM=100.0; and for eigenvalue problems either 1.E-12 or 1.E-8 is used depending on the shell element type. In the latter case, the input value for DRCPRM is ignored.
AUTOSPC	Automatic Constraint Scan flag EQ.1: scan the assembled stiffness matrix looking for unconstrained, unattached degrees of freedom. Generate additional constraints as necessary to avoid negative eigenvalues. EQ.2: do not add constraints.
AUTOTOL	AUTOSPC tolerance. The test for singularity is the ratio of the smallest singular value and the largest singular value. If this ratio is less than AUTOTOL, then the triple of columns are declared singular and a constraint is generated. Default value in single precision is 1.E-4 and in double precision, 1.E-8.
LCPACK	Matrix assembly package. EQ.2: Use v970's LCPACK (default, only available option in 971)



VARIABLE	DESCRIPTION
MTXDMP	<p>Matrix and right-hand-side dumping. To assist in evaluating other linear equation solution package, LS-DYNA has the option of dumping the globally assembled stiffness matrix and right-hand-side vectors to ASCII files in Harwell-Boeing sparse matrix format.</p> <p>EQ.0: No dumping  EQ.1: Dump all matrices and right-hand-side vectors every MTXDMP time steps. Filenames of the form K.matrix.xxxx, M.matrix.xxxx, and RHS.vector.xxxx are used.</p>
<b><u>Remarks:</u></b>	
LSOLVR	<p>The linear solver is used to compute the inverse of the global stiffness matrix, which is a costly procedure both in memory and cpu time. Direct solvers apply Gaussian elimination, while iterative solvers successively improve “guesses” at the correct solution. Iterative solvers require far less memory than direct solvers, but may suffer from convergence problems. Generally, iterative solvers are poor for automotive applications, but can be superior for large brick element soil models in civil engineering.</p> <p>Solvers 5 and 6 promote the global matrix to double precision before factoring to reduce numerical truncation error. Solvers 4 and 5 are equivalent if a double precision executable is used.</p> <p>Solver 6 is the direct linear equation solver from BCSLIB-EXT, Boeing's Extreme Mathematical Library. This option should be used whenever the factorization is too large to fit into memory. It has extensive capabilities for out-of-core solution and can solve larger problems than any of the other direct factorization methods. Solver 6 also includes a sophisticated pivoting strategy which can be superior for nearly singular matrices.</p>
LPRINT	<p>Select printing of the timing and storage information (LPRINT = 1) if you are comparing performance of linear equation solvers, or if you are running out of memory for large models. Minimum memory requirements for in-core and out-of-core solution are printed. This flag can also be toggled using sense switch "&lt;ctrl-c&gt; lprint". For best performance, increase available memory using <i>memory=</i> “ <i>on the command line until an IN-CORE</i> solution is indicated.</p> <p>When using solver option 6, LPRINT = 2 and 3 will cause increased printed output of statistics and performance information.</p>
NEGEV	<p>Negative eigenvalues result from underconstrained models (rigid body modes), severely deformed elements, or non-physical material properties. This flag allows control to be passed directly to the automatic time step controller when negative eigenvalues are detected. Otherwise, significant numerical roundoff error is likely</p>

to occur during factorization, and equilibrium iterations may fail (see \*CONTROL\_IMPLICIT\_AUTO).

ORDER The system of linear equations is reordered to optimize the sparsity of the factorization when using direct methods. Metis is a ordering method from University of Minnesota which is very effective for larger problems and for 3D solid problems, but also very expensive. MMD is inexpensive, but may not produce an optimum reordering, leading to higher cost during numeric factorization. MMD is usually best for smaller problems (less than 100,000 degrees of freedom).

Reordering cost is included in the symbolic factorization phase of the linear solver (LPRINT.ge.1). For large models, if this cost exceeds 20% of the numeric factorization cost, it may be more efficient to select the MMD method.

Note that the values of LPRINT and ORDER also affect the eigensolution software. That is LPRINT and ORDER from this keyword card is applicable to eigensolution.

**\*CONTROL\_IMPLICIT\_STABILIZATION**

Purpose: This optional card applies to implicit calculations. Artificial stabilization is required for multi-step unloading in implicit springback analysis (see also \*CONTROL\_IMPLICIT\_GENERAL).

Card            1            2            3            4            5            6            7            8

Variable	IAS	SCALE	TSTART	TEND				
Type	I	F	F	F				
Default	2	1.0	(see below)	(see below)				

<u>VARIABLE</u>	<u>DESCRIPTION</u>
IAS	Artificial Stabilization flag EQ.1: active EQ.2: inactive (default)
SCALE	Scale factor for artificial stabilization. For flexible parts with large springback, like outer body panels, a value of 0.001 may be required. EQ.-n: curve ID = n gives SCALE as a function of time
TSTART	Start time. (Default: immediately upon entering implicit mode)
TEND	End time. (Default: termination time)

**Remarks:**

Artificial stabilization allows springback to occur over several steps. This is often necessary to obtain convergence during equilibrium iterations on problems with large springback deformation. Stabilization is introduced at the start time TSTART, and slowly removed as the end time TEND is approached. Intermediate results are not accurate representations of the fully unloaded state. The end time TEND must be reached exactly for total springback to be predicted accurately.

IAS            The default for IAS depends on the analysis type in \*CONTROL\_IMPLICIT\_GENERAL. For “seamless” springback analysis, automatic time step control and artificial stabilization are activated by default. Otherwise, IAS is inactive by default.

SCALE

This is a penalty scale factor similar to that used in contact interfaces. If modified, it should be changed in order-of-magnitude increments at first. Large values suppress springback deformation until very near the termination time, making convergence during the first few steps easy. Small values may not stabilize the solution enough to allow equilibrium iterations to converge.

**\*CONTROL\_IMPLICIT\_STATIC\_CONDENSATION\_{OPTION}**

Available options include:

**<BLANK>**

**BINARY**

Purpose: Request static condensation of a part to build a reduced linearized model for later computation with \*ELEMENT\_DIRECT\_MATRIX\_INPUT. Optionally the analysis can continue using the linearization for the current analysis.

Card            1            2            3            4            5            6            7            8

Variable	SC_FLAG	SC_NSID	SC_PSID	SE_MASS	SE_STIFF	SE_INERT		
Type	I	I	I	C	C	C		
Default	0	0	0					

Card 2

Variable	SE_FILENAME
Type	C

<u>VARIABLE</u>	<u>DESCRIPTION</u>
SC_FLAG	Static Condensation Control Flag EQ.0: no static condensation will be performed EQ.1: create superelement representation based on static condensation. EQ.2: use static condensation to build a linearized representation for a part and use that linearized representation in the following analysis.
SC_NSID	Node set ID for nodes to be preserved in the static condensation procedure. Required when SC_FLAG = 1.

<u>VARIABLE</u>	<u>DESCRIPTION</u>
SC_PSID	Part set ID for parts to be included in the static condensation procedure. When SC_FLAG = 1 SC_PSID can be used to specify a subset of the model with the default being the entire model. When SC_FLAG = 2 SC_PSID is required. SC_PSID = 0 implies that the entire model is condensed.
SE_MASS	Name of the superelement mass matrix. If left blank it is not generated.
SE_STIFF	Name of the superelement stiffness matrix. If left blank it is not generated.
SE_INERT	Name of the superelement inertia matrix, required for gravity loading applications of the superelement. If left blank it is not generated.
SE_FILENAME	If any of SE_MASS, SE_DAMP, SE_STIFF, or SE_INERT is blank then the second line is required and contains the file name for the superelement.

**Remarks:**

To use this feature, an implicit analysis must be requested using IMFLAG=1 on \*CONTROL\_IMPLICIT\_GENERAL, and a non-zero termination time must be specified on \*CONTROL\_TERMINATION. A double precision version of LS-DYNA should be used for best accuracy. The superelement model is written to file SE\_FILENAME.

Static condensation is the reduction of the global stiffness and mass matrices to a specified sets of rows and columns associated with the nodes in the node set SC\_NSID. The first and second node set attribute parameters can be optionally used to restrict the translational and rotational degrees of freedom for which modes are requested, respectively, according to the following syntax:

Node set attribute parameters DA1 and A1: translational degree of freedom codes

Node set attribute parameters DA2 and A2: rotational degree of freedom codes

<u>code</u>	<u>modes computed</u>
0	(See note below.)
1	X degree of freedom only
2	Y degree of freedom only
3	Z degree of freedom only
4	X, Y degrees of freedom only
5	Y, Z degrees of freedom only
6	X, Z degrees of freedom only
7	X, Y, Z degrees of freedom

Setting both node set attributes to zero is equivalent to setting both node set attributes to 7 (X, Y, and Z for translational and rotational degrees of freedom).

If one node set attribute is nonzero (codes 1 to 7) and the other node set attribute is zero, then the zero attribute means NO degrees of freedom are considered. For example, if DA1=2 and DA2=0, then only the Y-translational degree of freedom modes are calculated.

The user can create the superelement representation of the reduced model by specifying the SE\_MASS, SE\_STIFF, SE\_INERT and SE\_FILENAME fields. This implementation does not include SE\_DAMP. The file, by default is written in the Nastran DMIG file format and can be used as input to \*ELEMENT\_DIRECT\_MATRIX\_INPUT. The keyword option \_BINARY can be used to create a binary representation for the superelement which can be used with \*ELEMENT\_DIRECT\_MATRIX\_INPUT\_BINARY to reduce the file size.

Static Condensation is equivalent to using only constraint modes with \*CONTROL\_IMPLICIT\_MODES.

Static Condensation does have the ability to continue the analysis using the linear representation for a part set.

# \*CONTROL

# \*CONTROL\_IMPLICIT\_TERMINATION

## \*CONTROL\_IMPLICIT\_TERMINATION

Purpose: Specify termination criteria for implicit transient simulations.

Card 1            1            2            3            4            5            6            7            8

Variable	DELTAU	DELTA1	KETOL	IETOL	TETOL	NSTEP		
Type	F	F	F	F	F	I		
Default	0.0	0.0	0.0	0.0	0.0	3		

### VARIABLE

### DESCRIPTION

DELTAU	Terminate based on relative total displacement in the Euclidean norm. GT.0.0: terminate when displacement in the Euclidean norm for last time step relative to the total displacement in the Euclidean norm is less than DELTAU.
DELTA1	Terminate based on relative total displacement in the max norm. GT.0.0: terminate when displacement in the max norm for last time step relative to the total displacement in the max norm is less than DELTAU.
KETOL	Terminate based on kinetic energy GT.0.0: terminate when kinetic energy drops below KETOL for NSTEP consecutive implicit time steps.
IETOL	Terminate based on internal energy GT.0.0: terminate when internal energy drops below IETOL for NSTEP consecutive implicit time steps.
TETOL	Terminate based on total energy GT.0.0: terminate when total energy drops below TETOL for NSTEP consecutive implicit time steps.
NSTEP	Number of steps used in the early termination tests for kinetic, internal, and total energy.



**Remarks:**

For some implicit applications it is useful to terminate when there is no change in displacement or low energy. This keyword provides the ability to specify such a stopping criterias to terminate the simulation prior to ENDTIM.

# \*CONTROL

## \*CONTROL\_MPP\_CONTACT\_GROUPABLE

### \*CONTROL\_MPP\_CONTACT\_GROUPABLE

Purpose: Allow for global specification that the GROUPABLE algorithm should be enabled/disabled for contacts when running MPP.

Card            1            2            3            4            5            6            7            8

Variable	GRP							
Type	I							
Default	None							

#### VARIABLE

#### DESCRIPTION

GRP

The sum of these available options (in any combination that makes sense):

- 1: Turn on GROUPABLE for all non-tied contacts
- 2: Turn on GROUPABLE for all tied contacts
- 4: Turn off GROUPABLE for all non-tied contacts
- 8: Turn off GROUPABLE for all tied contacts

#### Remarks:

The GROUPABLE algorithm is an alternate MPP communication algorithm for SINGLE\_SURFACE, NODE\_TO\_SURFACE, and SURFACE\_TO\_SURFACE contacts. The new algorithm does not support all contact options, including SOFT=2, as of yet, and is still under development. It can be significantly faster and scale better than the normal algorithm when there are more than two or three applicable contact types defined in the model. Its intent is to speed up the contact processing but not to change the behavior of the contact.

Because not all MPP contacts are supported with the GROUPABLE algorithm while some other contact types always use it, some contacts may not be affected by this option. This keyword will override any setting of the GRPABLE parameter on the \*CONTACT\_...\_MPP card, and is intended as a way to quickly experiment with this feature. The equivalent pfile option is “contact { groupable GRP }” where GRP is an integer as described above.

**\*CONTROL\_MPP\_DECOMPOSITION\_ARRANGE\_PARTS**

Purpose: Allow users to distribute certain part(s) to all processors or to isolate certain part(s) to single processor. This keyword allows multiple entries and each entry will be processed as a separate region for decomposition.

Card            1            2            3            4            5            6            7            8

Variable	ID	TYPE						
Type	I	I						
Default	None	None						

<u>VARIABLE</u>	<u>DESCRIPTION</u>
ID	Part ID/Part set ID
TYPE	EQ. 0: Part ID to be distributed to all processors 1: Part Set ID to be distributed to all processors 10: Part ID to be lumped into one processor 11: Part Set ID to be lumped into one processor.

**Remarks:**

There is no equivalent option under pfile.

**\*CONTROL\_MPP\_DECOMPOSITION\_AUTOMATIC**

Purpose: Instructs the program to apply a simple heuristic to try to determine the proper decomposition for the simulation.

There are no input parameters. The existence of this keyword triggers the automated decomposition. This option should not be used if there is more than one occurrence of any of the following options in the model:

\*INITIAL\_VELOCITY

\*CHANGE\_VELOCITY

\*BOUNDARY\_PRESCRIBED\_MOTION

And the following control card must not be used:

\*CONTROL\_MPP\_DECOMPOSITION\_TRANSFORMATION

For the general case, it is recommended that you specify the proper decomposition using the command \*CONTROL\_MPP\_DECOMPOSITION\_TRANSFORMATION instead.

**\*CONTROL\_MPP\_DECOMPOSITION\_BAGREF**

Purpose: Using airbag reference geometry for decomposition instead the folded geometry

There are no input parameters. Using initial folded geometry for decomposition may cause load unbalance while the bag fully deployed. This option will allow to decompose the model in reference geometry to get better MPP load distribution while the bag is fully opened.

**Remarks:**

Command in partition file(pfile): BAGREF

## **\*CONTROL**

## **\*CONTROL\_MPP\_DECOMPOSITION\_CHECK\_SPEED**

---

### **\*CONTROL\_MPP\_DECOMPOSITION\_CHECK\_SPEED**

Purpose: Modifies the decomposition depending on the relative speed of the processors involved.

There are no input parameters. The existence of this keyword causes a short floating point timing routine to be executed on each processor. The information gathered is used during the decomposition, with faster processors being given a relatively larger portion of the problem. This option is not recommended on homogeneous systems.

## **\*CONTROL\_MPP\_DECOMPOSITION\_CONTACT\_DISTRIBUTE \*CONTROL**

### **\*CONTROL\_MPP\_DECOMPOSITION\_CONTACT\_DISTRIBUTE**

Purpose: Ensures that the indicated contact interfaces are distributed across all processors, which can lead to better load balance for large contact interfaces.

Card            1            2            3            4            5            6            7            8

Variable	ID1	ID2	ID3	ID4	ID5			
Type	I	I	I	I	I			
Default	None	None	None	None	None			

#### **VARIABLE**

#### **DESCRIPTION**

ID1            First contact interface ID to distribute. If no contact ID's are specified, the number given here corresponds to the order of the interfaces as they appear in the input, with the first being 1.

ID2, ID3, ID4, ID5            Remaining interfaces ID's to distribute.

#### **Remarks:**

Up to 5 contact interface ID's can be specified. The decomposition is modified as follows: First, all the elements involved in the first contact interface are decomposed across all the processors. Then all the elements involved in the second contact interface (excluding any already assigned to processors) are distributed, and so on. After all the contact interfaces given are processed, the rest of the input is decomposed in the normal manner. This will result in each processor having possibly several disjoint portions of the input assigned to it, which will increase communications somewhat. However, this can be offset by improved load balance in the contact. It is generally recommended that at most one or two interfaces be specified, and then only if they are of substantial size relative to the whole problem.

# \*CONTROL

## \*CONTROL\_MPP\_DECOMPOSITION\_CONTACT\_ISOLATE

### \*CONTROL\_MPP\_DECOMPOSITION\_CONTACT\_ISOLATE

Purpose: Ensures that the indicated contact interfaces are isolated on a single processor, which can lead to decreased communication.

Card            1            2            3            4            5            6            7            8

Variable	ID1	ID2	ID3	ID4	ID5			
Type	I	I	I	I	I			
Default	None	None	None	None	None			

#### VARIABLE

#### DESCRIPTION

ID1

First contact interface ID to isolate. If no contact ID's are specified, the number given here corresponds to the order of the interfaces as they appear in the input, with the first being 1.

ID2, ID3, ID4, ID5

Remaining interfaces ID's to isolate.

#### Remarks:

Up to 5 contact interfaces can be specified. The decomposition is modified as follows: First, all the elements involved in the first contact interface ID are assigned to the first processor. Then all the elements involved in the second contact interface ID (excluding any already assigned to processors) are assigned to the next processor, and so on. After all the contact interfaces given are processed, the rest of the input is decomposed in the normal manner. This will result in each of the interfaces being processed on a single processor. For small contact interfaces this can result in better parallelism and decreased communication.



**\*CONTROL\_MPP\_DECOMPOSITION\_DISTRIBUTE\_ALE\_ELEMENTS**

Purpose: Ensures ALE elements are evenly distributed to all processors

There are no input parameters. ALE elements usually have higher computational cost than other type of elements and it is better to distribute them to all CPU for better load balance. The existence of this keyword causes DYNA/MPP to extract ALE parts from input and then evenly distributed to all processors.

**Remarks:**

Command in partition file(pfile): ALEDIST.

## **\*CONTROL**

## **\*CONTROL\_MPP\_DECOMPOSITION\_DISTRIBUTE\_SPH**

---

### **\*CONTROL\_MPP\_DECOMPOSITION\_DISTRIBUTE\_SPH\_ELEMENTS**

Purpose: Ensures SPH elements are evenly distributed to all processors

There are no input parameters. SPH elements usually have higher computational cost than other type of elements and it is better to distribute them to all CPU for better load balance. The existence of this keyword causes DYNA/MPP to extract SPH parts from input and then evenly distributed to all processors.

#### **Remarks:**

Command in partition file (pfile): SPHDIST

**\*CONTROL\_MPP\_DECOMPOSITION\_ELCOST**

Purpose: Instructs the program to use a hardware specific element cost weighting for the decomposition

Card            1            2            3            4            5            6            7            8

Variable	ITYPE								
Type	I								
Default	None								

**VARIABLE**

**DESCRIPTION**

ITYPE

Hardware specific cost profile.  
EQ.1: Fujitsu PrimePower  
EQ.2: Intel IA 64, AMD Opteron  
EQ.3: Intel Xeon 64  
EQ.4: General profile

**Remarks:**

Command in partition file(pfile): elcost itype.

# \*CONTROL

# \*CONTROL\_MPP\_DECOMPOSITION\_FILE

## \*CONTROL\_MPP\_DECOMPOSITION\_FILE

Purpose: Allow for pre-decomposition and a subsequent run or runs without having to do the decomposition.

Card            1            2            3            4            5            6            7            8

Variable	Name							
Type	A80							
Default	None							

### VARIABLE

### DESCRIPTION

NAME

Name of a file containing (or to contain) a decomposition record.

### Remarks:

If the indicated file does not exist, it is created with a copy of the decomposition information from this run. If the file exists, it is read and the decomposition steps can be skipped. The original run that created the file must be for a number of processors that is a multiple of the number of processors currently being used. Thus, a problem can be decomposed once for, say, 48 processors. Subsequent runs are then possible on any number that divides 48: 1, 2, 3, 4, 6, etc. Since the decomposition phase generally requires more memory than execution, this allows large models to be decomposed on one system and run on another (provided the systems have compatible binary formats). The file extension “.pre” is added automatically.

**\*CONTROL\_MPP\_DECOMPOSITION\_METHOD**

Purpose: Specify the decomposition method to use.

Card

Variable	Name
Type	A80
Default	RCB

**VARIABLE**

**DESCRIPTION**

NAME

Name of the decomposition method to use. There are currently two options:

- RCB = recursive coordinate bisection
- GREEDY = a simple heuristic method

In almost all cases the RCB method is superior and should be used.

# \*CONTROL

## \*CONTROL\_MPP\_DECOMPOSITION\_NUMPROC

### \*CONTROL\_MPP\_DECOMPOSITION\_NUMPROC

Purpose: Specify the number of processors for decomposition.

Card            1            2            3            4            5            6            7            8

Variable	N							
Type	I							
Default	None							

#### VARIABLE

#### DESCRIPTION

N

Number of processors for decomposition.

#### **Remarks:**

This is used in conjunction with the CONTROL\_MPP\_DECOMPOSITION\_FILE command to allow for later runs on different numbers of processors. By default, the decomposition is performed for the number of processors currently being used. However, a different value can be specified here. If  $N > 1$  and only one processor is currently being used, the decomposition is done and then the program terminates. Similarly, if N is NOT a multiple of the current number of processors, the execution terminates after decomposition. Otherwise, the decomposition is performed for N processors, and the execution continues.

**\*CONTROL\_MPP\_DECOMPOSITION\_OUTDECOMP**

Purpose: Instructs the program to output element's ownership data to file for post-processor to show state data from different processors

Card            1            2            3            4            5            6            7            8

Variable	TYPE							
Type	I							
Default	None							

**VARIABLE**

**DESCRIPTION**

ITYPE

1: database in ls-prepost format to file decomp\_parts.lsprepost.  
2: database in animator format to file decomp\_parts.ses

**Remarks:**

Command in partition file(pfile): OUTDECOMP ITYPE.

# \*CONTROL

## \*CONTROL\_MPP\_DECOMPOSITION\_RCBLOG

### \*CONTROL\_MPP\_DECOMPOSITION\_RCBLOG

Purpose: Causes the program to record decomposition information in the indicated file, for use in subsequent analyses.

Card            1            2            3            4            5            6            7            8

Variable	FILENAME
Type	Character
Default	None

#### VARIABLE

#### DESCRIPTION

FILENAME

Name of output file where decomposition history will be recorded. This file can be used as the pfile for later analyses.

#### Remarks:

Command in parallel option file(pfile): rcblog filename.



**\*CONTROL\_MPP\_DECOMPOSITION\_PARTS\_DISTRIBUTE**

Purpose: Distribute the parts given in this option to all processors before the decomposition for the rest of the model is performed. Only the first occurrence of this option will be activated and the rest of them will be ignored. The option in pfile has higher priority than in keyword.

Card            1            2            3            4            5            6            7            8

Variable	ID1	ID2	ID3	ID4	ID5	ID6	ID7	ID8
Type	I	I	I	I	I	I	I	I
Default	None	None	None	None	None	None	None	None

**VARIABLE**

**DESCRIPTION**

ID1, ID2, ID3, ...

Part ID to be distributed. If ID1, ID2,.. < 0, abs(ID1) will be used as part set ID. All parts defined in this card will be treated as a single region to be decomposed.

**Remarks:**

Up to 16 parts/part sets can be specified. The decomposition is modified as follows: First, all the elements involved in the given parts will be treated as separate domain from the model and distributed to all processors evenly based on their computational cost. Then the remainder of the model will be distributed.

Command in partition file(pfile): PARTLIST ID1, ID2, ID3, ....

Part set is not supported under pfile option

# **\*CONTROL \*CONTROL\_MPP\_DECOMPOSITION\_PARTSET\_DISTRIBUTE**

---

## **\*CONTROL\_MPP\_DECOMPOSITION\_PARTSET\_DISTRIBUTE**

Purpose: Distribute the partsets given in this option to all processors before the decomposition for the remainder of the model is performed.

Card            1            2            3            4            5            6            7            8

Variable	ID1	ID2	ID3	ID4	ID5	ID6	ID7	ID8
Type	I	I	I	I	I	I	I	I
Default	None	None	None	None	None	None	None	None

---

**VARIABLE**

---

---

**DESCRIPTION**

---

ID1, ID2, ID3, ...            Partset ID to be distributed.. All parts in ID1 will be shared across all processors. Then all parts in ID2 will be distributed, and so on..

### **Remarks:**

Any number of partsets can be specified. Each partset is distributed across all processors, in the order given. The order may be significant, in particular if a part ID is in more than one set. Distribution of these parts is done before any decomposition specifications given in the pfile.

**\*CONTROL\_MPP\_DECOMPOSITION\_RCBLOG**

Purpose: Indicate the file name for saving/restoring decomposition information..

Card 1

Variable	Name
Type	Character
Default	None

**VARIABLE****DESCRIPTION**

Name

Name of file..

**Remarks:**

Older versions of MPP-DYNA recorded decomposition information in a binary format file, for use in subsequent models. The use of this binary format is discouraged, since changes to the decomposition in the pfile (in particular, a change in the number of decomposition regions) will cause unexpected results. (It is still possible to write this format using the “rcblogold” pfile command).

If the indicated file exists, it is assumed to be one of these old style binary files, and it is used as such during the decomposition for this run. (These binary files have the extension “.rcb” and this extension will be added if it is not already present.) If no such file exists, then the file (without any additional “.rcb” extension – the name is used as given) will be used to record the current decomposition in the new ASCII format. The new format consists of a duplicate of the currently active pfile, with the addition of “history” information in each decomposition region.

To use the new format rcblog, simply take the created file and use it as the pfile for the subsequent analysis.

# **\*CONTROL \*CONTROL\_MPP\_DECOMPOSITION\_SCALE\_CONTACT\_COST**

---

## **\*CONTROL\_MPP\_DECOMPOSITION\_SCALE\_CONTACT\_COST**

Purpose: Instructs the program to apply a scale factor to the list of contacts to change the partition weight for the decomposition.

Card            1            2            3            4            5            6            7            8

Variable	SF	ID1	ID2	ID3	ID4	ID5	ID6	ID7
Type	F	I	I	I	I	I	I	I
Default	None	None	None	None	None	None	None	None

---

**VARIABLE**

---

**DESCRIPTION**

---

SF

Scale factor for the contact segments listed in the interface ID.

ID1, ID2,...

interfaces ID's to be considered for scaling. Include second card if necessary.

### **Remarks:**

Up to 15 contact interfaces ID can be specified. The decomposition is modified by applying this scale factor to the default computational cost of elements for the given contact interface ID.

Command in partition file(pfile): CTCOST ID1,ID2,....,SF

**\*CONTROL\_MPP\_DECOMPOSITION\_SCALE\_FACTOR\_SPH**

Purpose: Instructs the program to apply a scale factor to SPH elements to change the partition weight for the decomposition.

Card            1            2            3            4            5            6            7            8

Variable	SF							
Type	F							
Default	None							

**VARIABLE**

**DESCRIPTION**

ITYPE

1: database in ls-prepost format to file decomp\_parts.lsprepost.  
2: database in animator format to file decomp\_parts.ses

**Remarks:**

Command in partition file(pfile): SPHSF SF.

**\*CONTROL\_MPP\_DECOMPOSITION\_SHOW**

Purpose: Allows display of the final decomposition. There are no input parameters. The existence of this keyword causes the d3plot file to be modified so that all elements belonging to the first processor have material type 1, those on the second processor type 2, and so on. Execution terminates immediately after the decomposition phase, and no simulation is performed. This can be used in conjunction with the CONTROL\_MPP\_DECOMPOSITION\_NUMPROC command to run on 1 processor and produce a d3plot file to visualize the resulting decomposition.

**\*CONTROL\_MPP\_DECOMPOSITION\_TRANSFORMATION**

Purpose: Specifies transformations to apply to modify the decomposition.

There are 10 different transformations that can be applied. The input is described here. For a detailed description of each decomposition transformation, see the description in the Appendix for the "pfile".

Any number of transformations can appear with no need for further \*CONTROL cards – all non-comment cards up the next control card are expected to be decomposition transformations.

**The first 6 transformations each take one parameter:**

Card            1            2            3            4            5            6            7            8

Variable	TYPE	VAL						
Type	A10	F						
Default	None	0.0						

**VARIABLE**

**DESCRIPTION**

TYPE            Which transformation to apply. The possible values are: RX, RY, RZ, SX, SY, SZ

VAL             The amount of scaling/rotation to apply.

**The remaining 4 transformations each take 9 parameters:**

Card 1            1            2            3            4            5            6            7            8

Variable	TYPE	V1	V2	V3	V4	V5	V6	
Type	A10	F	F	F	F	F	F	
Default	None	0.0	0.0	0.0	0.0	0.0	0.0	

# \*CONTROL

## \*CONTROL\_MPP\_DECOMPOSITION\_TRANSFORMATION

Card 2            1            2            3            4            5            6            7            8

Variable	V7	V8	V9					
Type	F	F	F					
Default	0.0	0.0	0.0					

### VARIABLE

### DESCRIPTION

TYPE            Which transformation to apply. The possible values are: VEC3, C2R, S2R, MAT

V1-V9            Parameters to the transformation.



**\*CONTROL\_MPP\_IO\_LSTC\_REDUCE**

Purpose: Use LSTC' own reduce routine to get consistent summation of floating point data among processors. The option is only working with single precision (I4R4) releases. There are no input parameters.

**Remarks:**

Command in partition file (pfile): lstc\_reduce

**\*CONTROL\_MPP\_IO\_NOBEAMOUT**

Purpose: Suppress beam, shell, and solid element failure messages in the d3hsp and message files. There are no parameters for this keyword.

**Remarks:**

Command in parallel option file (pfile): nobeamout

**\*CONTROL\_MPP\_IO\_NOD3DUMP**

Purpose: Suppresses the output of all dump files.

There are no input parameters. The existence of this keyword causes the d3dump and runrsf file output routines to be skipped.

**\*CONTROL\_MPP\_IO\_NODUMP**

Purpose: Suppresses the output of all dump files and full deck restart files.

There are no input parameters. The existence of this keyword causes the d3dump and runrsf file output routines to be skipped. It also suppresses output of the full deck restart file d3full.

**\*CONTROL\_MPP\_IO\_NOFAIL**

Purpose: Turn off failed element checking in MPP contact. If you know that no elements will fail, or that any such failure will not impact any of the contact calculations, turning on this option can increase the efficiency of the contact routines.

There are no input parameters

**\*CONTROL\_MPP\_IO\_NOFULL**

Purpose: Suppresses the output of the full deck restart files.

There are no input parameters. The existence of this keyword suppresses the output of the full deck restart file "d3full".

**\*CONTROL\_MPP\_IO\_SWAPBYTES**

Purpose: Swap bytes on some of the output files.

There are no input parameters. The existence of this keyword causes the d3plot file and the “interface component analysis” file to be output with bytes swapped. This is to allow further processing of data on a different machine that has big endian vs. little endian incompatibilities compared to the system on which the analysis is running.

# \*CONTROL

# \*CONTROL\_NONLOCAL

## \*CONTROL\_NONLOCAL

Purpose: Allocate additional memory for \*MAT\_NONLOCAL option.

Card            1            2            3            4            5            6            7            8

Variable	MEM							
Type	I							
Default	none							

### VARIABLE

### DESCRIPTION

MEM

Percentage increase of memory allocated for MAT\_NONLOCAL option over that required initially. This is for additional storage that may be required due to geometry changes as the calculation proceeds. Generally, a value of 10 should be sufficient.



**\*CONTROL\_OUTPUT**

Purpose: Set miscellaneous output parameters. This keyword does not control the information, such as the stress and strain tensors, which is written into the binary databases. For the latter, see the keyword \*DATABASE\_EXTENT\_BINARY.

Card 1            1            2            3            4            5            6            7            8

Variable	NPOPT	NEECHO	NREFUP	IACCOP	OPIFS	IPNINT	IKEDIT	IFLUSH
Type	I	I	I	I	F	I	I	I
Default	0	0	0	0	0.	0	100	5000

**Optional Card 2**

Card 2            1            2            3            4            5            6            7            8

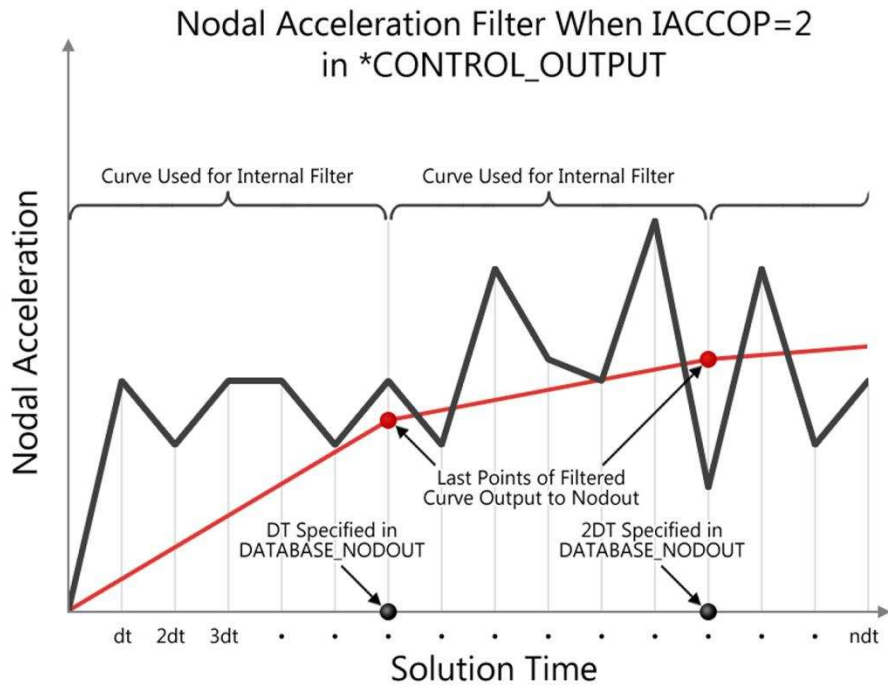
Variable	IPRTF	IERODE	TET10	MSGMAX	IPCURV	GMDT		
Type	I	I	I	I	I	F		
Default	0	0	2	50	0	0.		

<u>VARIABLE</u>	<u>DESCRIPTION</u>
NPOPT	Print suppression during input phase flag for the “d3hsp” file: EQ.0: no suppression, EQ.1: nodal coordinates, element connectivities, rigid wall definitions, nodal SPCs, and initial velocities are not printed.
NEECHO	Print suppression during input phase flag for echo file: EQ.0: all data printed, EQ.1: nodal printing is suppressed, EQ.2: element printing is suppressed, EQ.3: both node and element printing is suppressed.

<b>VARIABLE</b>	<b>DESCRIPTION</b>
NREFUP	<p>Flag to update reference node coordinates for beam formulations 1, 2, and 11. This option requires that each reference node is unique to the beam:</p> <p>EQ.0: Do not update reference node. EQ.1: Update reference node. This update is required for proper visualization of the beam cross-section orientation in LS-PrePost beyond the initial (t=0) plot state. NREFUP does not affect the internal updating of the beam cross-section orientation in LS-DYNA.</p>
IACCOP	<p>Flag to average or filter nodal accelerations output to file “nodout” and the time history database “d3thdt”:</p> <p>EQ.0: no average (default), EQ.1: averaged between output intervals, EQ.2: accelerations for each time step are stored internally and then filtered over each output interval using a filter from General Motors [Sala, Neal, and Wang, 2004] based on a low-pass Butterworth frequency filter. See also [Neal, Lin, and Wang, 2004]. DT2MS in *CONTROL_TIMESTEP must be set to a negative value when IACCOP=2 so that the maximum possible number of time steps for an output interval is known and adequate memory can be allocated. See Figure 11.13.</p>
OPIFS	<p>Output interval for interface file written per *INTERFACE_COMPONENT_option.</p>
IPNINT	<p>Flag controlling output of initial time step sizes for elements to d3hsp:</p> <p>EQ.0: 100 elements with the smallest time step sizes are printed. EQ.1: Time step sizes for all elements are printed.</p>
IKEDIT	<p>Problem status report interval steps to the “d3hsp” file. This flag is ignored if the “glstat” file is written, see *DATABASE_GLSTAT.</p>
IFLUSH	<p>Number of time steps interval for flushing I/O buffers. The default value is 5000. If the I/O buffers are not emptied and an abnormal termination occurs, the output files can be incomplete. The I/O buffers for restart files are emptied automatically whenever a restart file is written so these files are not affected by this option.</p>

---

<b>VARIABLE</b>	<b>DESCRIPTION</b>
IPRTF	<p>Default print flag for “rbdout” and “matsum” files. This flag defines the default value for the print flag which can be defined in the part definition section, see *PART. This option is meant to reduce the file sizes by eliminating data which is not of interest.</p> <p>EQ.0: write part data into both matsum and rbdout EQ.1: write data into rbdout file only EQ.2: write data into matsum file only EQ.3: do not write data into rbdout and matsum</p>
IERODE	<p>Output eroded internal and kinetic energy into the “matsum” file. Also, output to the “matsum” file under the heading of part ID 0 is the kinetic energy from nonstructural mass, lumped mass elements and lumped inertia elements.</p> <p>EQ.0: do not output extra data EQ.1: output the eroded internal and kinetic energy</p>
TET10	<p>Output ten connectivity nodes into “d3plot” database. The current default is set to 2 since this change in the database may make the data unreadable for many popular post-processors and older versions of Ls-prepost. The default will change to 1 later.</p> <p>EQ.1: write the full ten node connectivity into the “d3plot” database EQ.2: write the four corner nodes of the ten node connectivity into the “d3plot” database</p>
MSGMAX	Maximum number of each error/warning message
IPCURV	<p>Flag to output digitized curve data to messag and d3hsp files.</p> <p>EQ.0: off EQ.1: on</p>
GMDT	Output interval for recorded motions from *INTERFACE_SSI_AUX



**Figure 11.13.** Nodal Acceleration Filter for IACOOP=2.

**\*CONTROL\_PARALLEL**

Purpose: Control parallel processing usage for shared memory computers by defining the number of processors and invoking the optional consistency of the global vector assembly.

Card            1            2            3            4            5            6            7            8

Variable	NCPU	NUMRHS	CONST	PARA				
Type	I	I	I	I				
Default	1	0	2	0				
Remarks		1	2	3				

<u>VARIABLE</u>	<u>DESCRIPTION</u>
NCPU	Number of cpus used. (Disabled in 971 R5. Set number of cpus using “ncpu=” on the execution line (see Execution Syntax section of Getting Started) or on the *KEYWORD line of the input.)
NUMRHS	Number of right-hand sides allocated in memory: EQ.0: same as NCPU, always recommended, EQ.1: allocate only one.
CONST	Consistency flag. Option 2 is recommended for metal forming applications. EQ.1: on EQ.2: off, for a faster solution (default).
PARA	Flag for parallel force assembly if CONST=1. (“para=” on execution line overrides PARA.) EQ.0: off EQ.1: on

**Remarks:**

1. It is recommended to always set NUMRHS=NCPU since great improvements in the parallel performance are obtained since the force assembly is then done in parallel. Setting NUMRHS to one reduces storage by one right hand side vector for each

additional processor after the first. If the consistency flag is active, i.e.,  $CONST=1$ ,  $NUMRHS$  defaults to unity.

2. For any given problem with the consistency option off, i.e.,  $CONST=2$ , slight differences in results are seen when running the same job multiple times with the same number of processors and also when varying the number of processors. Comparisons of nodal accelerations often show wide discrepancies; however, it is worth noting that the results of accelerometers often show insignificant variations due to the smoothing effect of the accelerometers which are generally attached to nodal rigid bodies. The accuracy issues are not new and are inherent in numerical simulations of automotive crash and impact problems where structural bifurcations under compressive loads are common. This problem can be easily demonstrated by using a perfectly square thin-walled tubular beam of uniform cross section under a compressive load. Typically, every run on one processor that includes a minor input change (i.e., element or hourglass formulation) will produce dramatically different results in terms of the final shape, and, likewise, if the same problem is again run on a different brand of computer. If the same problem is run on multiple processors the results can vary dramatically from run to run WITH NO INPUT CHANGE. The problem here is due to the randomness of numerical round-off which acts as a trigger in a “perfect” beam. Since summations with ( $CONST=2$ ) occur in a different order from run to run, the round-off is also random. The consistency flag,  $CONST=1$ , provides for identical results (or nearly so) whether one, two, or more processors are used while running in the shared memory parallel (SMP) mode. This is done by requiring that all contributions to global vectors be summed in a precise order independently of the number of processors used. When checking for consistent results, nodal displacements or element stresses should be compared. The NODOUT and ELOUT files should be digit to digit identical. However, the GLSTAT, SECFORC, and many of the other ASCII files will not be identical since the quantities in these files are summed in parallel for efficiency reasons and the ordering of summation operations are not enforced. The biggest drawback of this option is the CPU cost penalty which is at least 15 percent if  $PARA=0$  and is much less if  $PARA=1$  and 2 or more processors are used. Unless the  $PARA$  flag is on (for non-vector processors), parallel scaling is adversely affected. The consistency flag does not apply to MPP parallel.
3. The  $PARA$  flag will cause the force assembly for the consistency option to be performed in parallel for the shared memory parallel option. Better scaling will be obtained with the consistency option, but with more memory usage. However, the single processing speed is slightly diminished. The logic for parallelization cannot be efficiently vectorized and is not recommended for vector computers since it will degrade CPU performance. This option does not apply to MPP parallel. If  $PARA=CONST=0$  and  $NUMRHS=NCPU$  the force assembly by default is done in parallel.

**\*CONTROL\_PORE\_FLUID**

Purpose: Set parameters for pore water pressure calculations.

Card 1            1            2            3            4            5            6            7            8

Variable	ATYPE	(blank)	WTABLE	PF_RHO	GRAV	PF_BULK	OUTPUT	TMF
Type	I	F	F	F	F	F	I	F
Default	0	0.0	0.0	(none)	(none)	(none)	0	1.0

Card 2            1            2            3            4            5            6            7            8

Variable	TARG	FMIN	FMAX	FTIED	CONV	CONMAX	ETERM	THERM
Type	F	F	F	F	F	F	F	F
Default	0.0	0.0	0.0	0.0	1.E-4	1.E20	0.0	0.0

**Card 3 is optional**

Card 3            1            2            3            4            5            6            7            8

Variable	ETFLAG							
Type	I							
Default	0							

---

<b>VARIABLE</b>	<b>DESCRIPTION</b>
ATYPE	Analysis type for pore water pressure calculations: EQ.0: No pore water pressure calculation. EQ.1: Undrained analysis, EQ.2: Drained analysis, EQ.3: Time dependent consolidation (coupled), EQ.4: Consolidate to steady state (uncoupled), EQ.5: Drained in dynamic relaxation, undrained in transient, EQ.6: As 4 but do not check convergence, continue to end time.
WTABLE	Default z-coordinate of water table (where pore pressure is zero).
PF_RHO	Default density for pore water.
GRAV	Gravitational acceleration used to calculate hydrostatic pore water pressure.
PF_BULK	Default bulk modulus of pore fluid (stress units).
OUTPUT	Output flag controlling stresses to D3PLOT and D3THDT binary files: EQ.0: total stresses are output EQ.1: effective stresses are output, see notes
TMF	Initial Time Magnification factor on seepage (ATYPE=3,4 only). GT.0: Factor (can be used with automatic control, see TARG, FMIN, FMAX). LT.0: Load Curve ID (see *DEFINE_CURVE) giving Time Magnification Factor versus analysis time.
TARG	Target for maximum change of excess pore pressure at any node, per timestep. If the actual change falls below the target, the time factor on the seepage calculation will be increased (see notes). If zero, the constant value of TMF is used. If non-zero, TMF is taken as the initial factor.
FMIN	Minimum time factor on seepage calculation
FMAX	Maximum time factor on seepage calculation
FTIED	Analysis type for pore water pressure calculations: EQ.0.0: Tied contacts act as impermeable membranes, EQ.1.0: Fluid may flow freely through tied contacts.
CONV	Convergence tolerance for ATYPE=4 – maximum head change per timestep at any node (length units)



---

<u>VARIABLE</u>	<u>DESCRIPTION</u>
CONMAX	Maximum factor on permeability with ATYPE=-4
ETERM	Event time termination (ATYPE=3)
THERM	Thermal expansion: Volumetric strain per degree increase for undrained soil.
ETFLAG	Flag for interpretation of time etc (see notes): EQ.0: Time means analysis time, EQ.1: Time means event time.

**Remarks:**

General	<p>LS-DYNA uses Terzaghi’s concept of Effective Stress to simulate materials with pore pressure. The pore fluid and soil skeleton are assumed to occupy the same volume and to carry loads in parallel. Thus the total stress in an element is the sum of the “effective stress” in the soil skeleton, plus the hydrostatic stress in the pore fluid. The “effective stress” is determined by the LS-DYNA material model in the normal way – the pore fluid treatment is independent of material model. The pore pressure is calculated at nodes, and interpolated onto the elements. The pore fluid hydrostatic stress is then the negative of the element pore pressure.</p> <p>The description here relates to analysis of soils, which is the main intended application, but other materials containing pore fluid could be treated by the same methods.</p> <p>The pore pressure capabilities are available in SMP and MPP versions of LS-DYNA (explicit solution method) but are not available for implicit solutions.</p>
Pressure head	<p>Pressure head (length units) = <math>\text{pressure}/\rho g</math> where <math>\rho</math>=pore fluid density (PF_RHO) and <math>g</math> is the acceleration due to gravity (GRAV).</p>
Analysis Types	<p>“Undrained”: the pore fluid is trapped within the material. Volume changes result in pore pressure changes. This approximation is used to simulate the effect of rapidly-applied loads on relatively impermeable soil.</p> <p>“Drained”: the pore fluid is free to move within the material such that the user-defined pressure-versus-z-coordinate relationship is always maintained. This approximation is used to model high-permeability soils.</p>

“Time-dependent consolidation”: pressure gradients cause pore fluid to flow through the material according to Darcy’s law:

$$\mathbf{v} = \kappa \cdot \text{grad}(p+z)$$

where  $\mathbf{v}$  = fluid velocity vector,  $\kappa$ =permeability,  $p$ =pressure head,  $z$ = $z$ -coordinate.

Nett inflow or outflow at a node leads to a theoretical volume gain or loss. The analysis is coupled, i.e. any difference between actual and theoretical volume leads to pore pressure change, which in turn affects the fluid flow. The result is a prediction of response-versus-time.

“Steady-state consolidation”: iterative calculation to achieve steady-state pore pressure. The analysis is uncoupled, i.e. only the final state is meaningful, not the response-versus-time.

#### Time factoring

Consolidation occurs over time intervals of days, weeks or months. To simulate this process using explicit time integration, a time factor is used. The permeability of the soil is increased by the time factor so that consolidation occurs more quickly. The output times in the D3PLOT and D3THDT files are modified to reflect the time factor. The factored time (“Event Time”) is intended to represent the time taken in the real-life consolidation process and will usually be much larger than the analysis time (the analysis time is the sum of the LS-DYNA timesteps). The time factor may be chosen explicitly (using TMF) but it is recommended to use automatic factoring instead. The automatic scheme adjusts the time factor according to how quickly the pore pressure is changing; usually at the start of consolidation the pore pressure changes quickly and the time factor is low; the time factor increases gradually as the rate of pore pressure change reduces. Automatic time factoring is input by setting TARG (the target pore pressure head change per timestep) and maximum and minimum allowable time factors, for example TARG = 0.001 to 0.01m head, FMIN = 1.0, FMAX = 1.0e6. Optimum settings for these are model-dependent.

Loading, other input data from loadcurves, and output time-intervals on \*DATABASE cards by default use the analysis time (for example, the x-axis of a loadcurve used for pressure loading is analysis time). When performing consolidation with automatic time-factoring, the relationship between analysis time and event time is unpredictable. Termination based on event time may be input using ETERM.

It may also be desired to apply loads as functions of event time rather than analysis time, since the event time is representative of the real-life process. By setting ETFLAG=2, the time axis of all loadcurves used for any type of input-versus-time, and output intervals on \*DATABASE

cards, will be interpreted as event time. This method also allows consolidation to be used as part of a staged construction sequence – when ETFLAG=2, the stages begin and end at the “real time” stage limits and input curves of pore pressure analysis type-vs-time may be used to enforce, for example, consolidation in some stages, and undrained behaviour in others.

**Tied Contacts**

By default, the mesh discontinuity at a tied contact will act as a barrier to fluid flow. If the flag FTIED is set to 1, then pore fluid will be transmitted across tied nodes in tied contacts (\*CONTACT\_TIED\_SURFACE\_TO\_SURFACE and \*CONTACT\_TIED\_NODES\_TO\_SURFACE, including \_OFFSET and non-\_OFFSET types). This algorithm has an effect only when the analysis type of at least one of the contacting parts is 3, 4 or 6.

**THERM**

Note that this property is for VOLUMETRIC strain increase. Typical thermal expansion coefficients are linear; the volumetric expansion will be three times the linear thermal expansion coefficient. Regular thermal expansion coefficients (e.g. on \*MAT or \*MAT\_ADD\_THERMAL\_EXPANSION) apply to the soil skeleton and to drained parts. Pore pressure can be generated due to the difference of expansion coefficients of the soil skeleton and pore fluid.

**Part Associativity**

Pore pressure is a nodal variable, but analysis type and other pore pressure related inputs are properties of parts. When a node is shared by elements of different parts, and those parts have different pore pressure inputs, the following rules are followed to determine which part's properties should be applied to the node.

- Dry parts (i.e. parts without a \*BOUNDARY\_PORE\_FLUID card) will never be used (lowest priority).
- If a part is initially dormant (due to staged construction inputs), it has next-lowest priority
- Parts with analysis type = drained have highest priority.
- Next, higher permeability gives higher priority
- If two or more parts have equal-highest priority at a node, the part with lowest ID will win.

**See also:**

\*BOUNDARY\_PORE\_FLUID (essential - without this card, no parts will have pore fluid)

\*BOUNDARY\_PWP\_option

\*DATABASE\_PWP\_OUTPUT

\*DATABASE\_PWP\_FLOW

\*MAT\_ADD\_PERMEABILITY

Output:

Extra variables for solid elements are automatically written to the d3plot and d3thdt files when the model contains \*CONTROL\_PORE\_FLUID. In LS971 R4 onwards, 5 additional extra variables are written, of which the first is the pore pressure in stress units. In LS971 R3, 15 additional extra variables are written, of which the seventh is pore pressure in stress units. These follow any extra variables requested by the user, e.g. if the user requested 3 extra variables, then in LS971 there will be a total of 8 extra variables of which the fourth is pore pressure.

Further optional output to d3plot and d3thdt files is available for nodal pore pressure variables – see \*DATABASE\_PWP\_OUTPUT.

For time-dependent and steady-state consolidation, information on the progress of the analysis is written to d3hsp file.

**\*CONTROL\_PORE\_AIR**

Purpose: Set parameters for pore air pressure calculations.

Card 1            1            2            3            4            5            6            7            8

Variable	AIR_RO	AIR_P	ETERM					
Type	F	F	F					
Default	(none)	(none)	endtim					

<u>VARIABLE</u>	<u>DESCRIPTION</u>
PA_RHO	Density of atmospheric air, = 1.184 kg/m <sup>3</sup> at 25°C
PA_PATM	Pressure of atmospheric air, = 101.325 kPa at 25°C
ETERM	Event termination time, default to ENDTIME of *CONTROL_TERMINATION

**\*CONTROL\_REMESHING**

Purpose: Provide control over the remeshing of solids which are meshed with the solid tetrahedron element type 13. The element size for three-dimensional adaptivity can be set on the surface mesh of the solid part, and adaptivity can be activated based on the criterions of volume loss, mass increase, or minimum time step size.

Card            1            2            3            4            5            6            7            8

Variable	RMIN	RMAX	VF_LOSS	MFRAC	DT_MIN			
Type	F	F	F	F	F			
Default	none	none	1.0	0.0	0.			

<u>VARIABLE</u>	<u>DESCRIPTION</u>
RMIN	Minimum edge length for the surface mesh surrounding the parts which should be remeshed.
RMAX	Maximum edge length for the surface mesh surrounding the parts which should be remeshed.
VF_LOSS	Volume fraction loss required in a type 13 solid elements to trigger a remesh. In the type 13 solid elements, the pressures are computed at the nodal points; therefore, it is possible for volume to be conserved but for individual tetrahedrons to experience a significant volume loss or gain. The volume loss can lead to numerical problems. Recommended values for VF_LOSS in the range of 0.10 to 0.30 may be reasonable.
MFRAC	Mass ratio gain during mass scaling required for triggering a remesh. For a one percent increase in mass, set MFAC=0.010.
DT_MIN	Time step size required for triggering a remesh. This option is checked before mass scaling is applied and the time step size reset.

**Remarks:**

1. The value of RMIN and RMAX should be of the same order. The value of RMAX can be set to 2-5 times greater than RMIN.

**\*CONTROL\_RIGID**

Purpose: Special control options related to rigid bodies and the rigid-flexible bodies, see \*PART\_MODES.

Card            1            2            3            4            5            6            7            8

Variable	LMF	JNTF	ORTHMD	PARTM	SPARSE	METALF	PLOTEL	
Type	I	I	I	I	I	I	I	
Default	0	0	0	0	0	0	0	

**VARIABLE**

**DESCRIPTION**

LMF            Switch the explicit rigid body joint treatment to an implicit formulation which uses Lagrange multipliers to impose prescribed kinematic boundary conditions and joint constraints. There is a slight cost overhead due to the assembly of sparse matrix equations which are solved using standard procedures for nonlinear problems in rigid multi-body dynamics. Lagrange multiplier flag:  
EQ.0: explicit penalty formulation,  
EQ.1: implicit formulation with Lagrange multipliers.

JNTF            Generalized joint stiffness formulation; see remark 1 below:  
EQ.0: incremental update,  
EQ.1: total formulation (exact).

ORTHMD        Orthogonalize modes with respect to each other:  
EQ.0: true.  
EQ.1: false, the modes are already orthogonalized.

PARTM         Use global mass matrix to determine part mass distribution. This mass matrix may contain mass from other parts that share nodes. See remark 2 below.  
EQ.0: true,  
EQ.1: false.

SPARSE        Use sparse matrix multiply subroutines for the modal stiffness and damping matrices. See Remark 3.  
EQ.0: false, do full matrix multiplies (frequently faster),  
EQ.1: true.

<u>VARIABLE</u>	<u>DESCRIPTION</u>
MATELF	<p>Metal forming option, which should not be used for crash and other applications involving rigid bodies. Use fast update of rigid body nodes. If this option is active the rotational motion of all rigid bodies should be suppressed.</p> <p>EQ.0: full treatment is used EQ.1: fast update for metalforming applications</p>
PLOTEL	<p>Automatic generation of *ELEMENT_PLOTEL for *CONSTRAINED_NODAL_RIGID_BODY.</p> <p>EQ.0: no generation EQ.1: one part is generated for all nodal rigid bodies with the PID set to 1000000. EQ.2: one part is generated for each nodal rigid body in the problem with a part ID of 1000000+PID, where PID is the nodal rigid body ID.</p>

**Remarks:**

1. As the default, the calculation of the relative angles between two coordinate systems is done incrementally. This is an approximation, in contrast to the total formulation where the angular offsets are computed exactly. The disadvantage of the latter approach is that a singularity exists when an offset angle equals 180 degrees. For most applications, the stop angles prevent this occurrence and JNTF=1 should not cause a problem.
2. If the determination of the normal modes included the mass from both connected bodies and discrete masses, or if there are no connected bodies, then the default is preferred. When the mass of a given part ID is computed, the resulting mass vector includes the mass of all rigid bodies that are merged to the given part ID, but does not include discrete masses. See the keyword: \*CONSTRAINED\_RIGID\_BODIES. A lumped mass matrix is always assumed.
3. Sparse matrix multipliers save a substantial number of operations if the matrix is truly sparse. However, the overhead will slow the multipliers for densely populated matrices.



**\*CONTROL\_SHELL****\*CONTROL****\*CONTROL\_SHELL**

Purpose: Provide controls for computing shell response.

Card            1            2            3            4            5            6            7            8

Variable	WRPANG	ESORT	IRNXX	ISTUPD	THEORY	BWC	MITER	PROJ
Type	F	I	I	I	I	I	I	I
Default	20.	0	-1	0	2	2	1	0

**First optional Card**

Card            1            2            3            4            5            6            7            8

Variable	ROTASCL	INTGRD	LAMSHT	CSTYP6	THSHEL			
Type	F	I	I	I	I			
Default	1..	0	0	1	0			

**Second optional Card (The first card must also be defined)**

Card            1            2            3            4            5            6            7            8

Variable	PSTUPD	SIDT4TU	CNTCO	ITSFLG	IRQUAD			
Type	I	I	I	I	I			
Default	1..	0	0	0	0			

**Third optional Card (The first and second card must also be defined)**

Card            1            2            3            4            5            6            7            8

Variable	NFAIL1	NFAIL4	PSNFAIL	KEEPCS	DELFR			
Type	I	I	I	I	I			
Default	inactive	inactive	0	0	0			

**VARIABLE****DESCRIPTION**

WRPANG	Shell element warpage angle in degrees. If a warpage greater than this angle is found, a warning message is printed. Default is 20 degrees.
ESORT	Automatic sorting of triangular shell elements to treat degenerate quadrilateral shell elements as C0 or DKT triangular shells, see option THEORY below: EQ.0: no sorting required (default), EQ.1: full sorting (C0 triangular shells), EQ.2: full sorting (DKT triangular shells) 971 version R3 and later. The DKT triangular element will be unstable if used to model a thick shell.
IRNXX	Shell normal update option. This option affects the Hughes-Liu, Belytschko-Wong-Chiang, and the Belytschko-Tsay shell formulations. The latter is affected if and only if the warping stiffness option is active, i.e., BWC=1. EQ.-2: unique nodal fibers which are incrementally updated based on the nodal rotation at the location of the fiber, EQ.-1: recomputed fiber directions each cycle, EQ.0: default set to -1, EQ.1: compute on restarts, EQ.n: compute every n cycles (Hughes-Liu shells only).

---

<u>VARIABLE</u>	<u>DESCRIPTION</u>
ISTUPD	<p>Shell thickness change option for deformable shells. The parameter, PSSTUPD, on the second optional card allows this option to be applied by part ID. For crash analysis, neglecting the elastic component of the strains, ISTUPD=4, may improve energy conservation and stability.</p> <p>EQ.0: no thickness change.</p> <p>EQ.1: membrane straining causes thickness change in 3 and 4 node shell elements. This option is very important in sheet metal forming or whenever membrane stretching is important.</p> <p>EQ.2: membrane straining causes thickness change in 8 node thick shell elements, types 1 and 2. This option is not recommended for implicit or explicit solutions which use the fully integrated type 2 element. The type 3 thick shell is a continuum based shell and thickness changes are always considered.</p> <p>EQ.3: options 1 and 2 apply.</p> <p>EQ.4: option 1 applies, but the elastic strains are neglected for the thickness update. This option only applies to the most common elastic-plastic materials for which the elastic response is isotropic.</p>

<b>VARIABLE</b>	<b>DESCRIPTION</b>
THEORY	<p>Default shell formulation (see Remark 2 below):</p> <ul style="list-style-type: none"><li>EQ.1: Hughes-Liu,</li><li>EQ.2: Belytschko-Tsay (default),</li><li>EQ.3: BCIZ triangular shell (not recommended),</li><li>EQ.4: C<sup>0</sup> triangular shell,</li><li>EQ.5: Belytschko-Tsay membrane,</li><li>EQ.6: S/R Hughes Liu,</li><li>EQ.7: S/R co-rotational Hughes Liu,</li><li>EQ.8: Belytschko-Leviathan shell,</li><li>EQ.9: fully integrated Belytschko-Tsay membrane,</li><li>EQ.10: Belytschko-Wong-Chiang,</li><li>EQ.11: Fast (co-rotational) Hughes-Liu.</li><li>EQ.12: Plane stress (x-y plane),</li><li>EQ.13: Plane strain (x-y plane),</li><li>EQ.14: Axisymmetric solid (y-axis of symmetry) - area weighted,</li><li>EQ.15: Axisymmetric solid (y-axis of symmetry) – volume weighted</li><li>EQ.16: Fully integrated shell element (very fast)</li><li>EQ.17: Discrete Kirchhoff triangular shell (DKT)</li><li>EQ.18: Discrete Kirchhoff linear shell either quadrilateral or Triangular with 6DOF per node,</li><li>EQ.20: C<sup>0</sup> linear shell element with 6 DOF per node</li><li>EQ.21: C<sup>0</sup> linear shell element with 5 DOF per node with the Pian-Sumihara membrane hybrid quadrilateral membrane.</li><li>EQ.25: Belytschko-Tsay shell with thickness stretch.</li><li>EQ.26: Fully integrated shell with thickness stretch.</li><li>EQ.27: C<sup>0</sup> triangular shell with thickness stretch.</li></ul> <p>For the 2D axisymmetric solid elements, high explosive applications work best with the area weighted approach and structural applications work best with the volume weighted approach. The volume weighted approach can lead to problems along the axis of symmetry under very large deformations. Often the symmetry condition is not obeyed, and the elements will kink along the axis. The volume weighted approach must be used if 2D shell elements are used in the mesh. Type 14 and 15 elements cannot be mixed in the same calculation.</p>
BWC	<p>Warping stiffness for Belytschko-Tsay shells:</p> <ul style="list-style-type: none"><li>EQ.1: Belytschko-Wong-Chiang warping stiffness added.</li><li>EQ.2: Belytschko-Tsay (default).</li></ul>
MITER	<p>Plane stress plasticity option (applies to materials 3, 18, 19, and 24):</p> <ul style="list-style-type: none"><li>EQ.1: iterative plasticity with 3 secant iterations (default),</li><li>EQ.2: full iterative plasticity,</li><li>EQ.3: radial return noniterative plasticity. May lead to false results and has to be used with great care.</li></ul>

VARIABLE	DESCRIPTION
PROJ	<p>Projection method for the warping stiffness in the Belytschko-Tsay shell (the BWC option above) and the Belytschko-Wong-Chiang elements (see Remark 1 below). This parameter applies to explicit calculations since the full projection method is always used if the solution is implicit and this input parameter is ignored.</p> <p>EQ.0: drill projection, EQ.1: full projection.</p>
ROTASCL	<p>Define a scale factor for the rotary shell mass. This option is not for general use. The rotary inertia for shells is automatically scaled to permit a larger time step size. A scale factor other than the default, i.e., unity, is not recommended.</p>
INTGRD	<p>Default shell through thickness numerical integration rule:</p> <p>EQ.0: Gauss integration. If 1-10 integration points are specified, the default rule is Gauss integration.</p> <p>EQ.1: Lobatto integration. If 3-10 integration points are specified, the default rule is Lobatto. For 2 point integration, the Lobatto rule is very inaccurate, so Gauss integration is used instead. Lobatto integration has an advantage in that the inner and outer integration points are on the shell surfaces.</p>
LAMSH	<p>Laminated shell theory is available for all thin shell and thick shell materials except those that use the Green-Lagrange strain by setting LAMSH=3, 4, or 5 and by using *PART_COMPOSITE or *INTEGRATION_SHELL to define the integration rule. Lamination theory is applied to correct for the assumption of a uniform constant shear strain through the thickness of the shell. Unless this correction is applied, the stiffness of the shell can be grossly incorrect if there are drastic differences in the elastic constants from ply to ply, especially for sandwich type shells. Generally, without this correction the results are too stiff. For the discrete Kirchhoff shell elements, which do not consider transverse shear, this option is ignored. For thin shells of material types, *MAT_COMPOSITE_DAMAGE, *MAT_ENHANCED_COMPOSITE_DAMAGE, and *MAT_GENERAL_VISCOELASTIC, laminated shell theory may also be done by stiffness correction by setting LAMSH=1.</p> <p>EQ.0: do not update shear corrections, EQ.1: activate laminated shell theory, EQ.3: activate laminated thin shells, EQ.4: activate laminated shell theory for thick shells, EQ.5: activate laminated shell theory for thin and thick shells.</p>

---

<b>VARIABLE</b>	<b>DESCRIPTION</b>
CSTYP6	<p>Coordinate system for the type 6 shell element. The default system computes a unique local system at each in plane point. The uniform local system computes just one system used throughout the shell element. This involves fewer calculations and is therefore more efficient. The change of systems has a slight effect on results; therefore, the older, less efficient method is the default.</p> <p>EQ.1: variable local coordinate system (default), EQ.2: uniform local system.</p>
THSHEL	<p>Thermal shell option. Four node shells are treated internally as twelve node brick elements to allow heat conduction through the thickness of the shell.</p>
PSTUPD	<p> PSTUPD  is the optional shell part set ID specifying which part ID's have or do not have their thickness updated. The shell thickness update by default applies to all shell elements in the mesh. Generally, this part set ID is not needed.</p> <p>LT.0: these shell parts are excluded from the shell thickness update EQ.0: all deformable shells have their thickness updated GT.0: these shell parts are included in the shell thickness update</p>
SIDT4TU	<p>Part set ID for parts which use the type 4 thickness update where elastic strains are ignored. This option is useful if different components of the final model are validated using different update options.:</p>
CNTCO	<p>Flag to account for shell reference surface offsets in the contact treatment</p> <p>EQ.0: offsets are ignored EQ.1: offsets are treated using shell thickness EQ.2: offsets are treated using the user defined contact thickness which may be different than the shell thickness used in the element formulations</p>
ITSFLG	<p>Flag to activate/deactivate initial transverse shear stresses:</p> <p>EQ.0: keep transverse shear stresses EQ.1: set transverse shear stresses to zero</p>
IRQUAD	<p>In plane integration rule for the 8 node shell element:</p> <p>EQ.2: 2 x 2 Gauss quadrature, EQ.3: 3 x 3 Gauss quadrature.</p>

---

<u>VARIABLE</u>	<u>DESCRIPTION</u>
NFAIL1	<p>Flag to check for highly distorted under-integrated shell elements, print a message, and delete the element or terminate. Generally, this flag is not needed for one point elements that do not use the warping stiffness. A distorted element is one where a negative Jacobian exist within the domain of the shell, not just at integration points. The checks are made away from the CPU requirements for one point elements. If nonzero, NFAIL1 can be changed in a restart.</p> <p>EQ.1: print message and delete element. EQ.2: print message, write D3DUMP file, and terminate GT.2: print message and delete element. When NFAIL1 elements are deleted then write D3DUMP file and terminate. These NFAIL1 failed elements also include all shell elements that failed for other reasons than distortion. Before the D3DUMP file is written, NFAIL1 is doubled, so the run can immediately be continued if desired.</p>
NFAIL4	<p>Flag to check for highly distorted fully-integrated shell elements, print a message and delete the element or terminate. Generally, this flag is recommended. A distorted element is one where a negative Jacobian exist within the domain of the shell, not just at integration points. The checks are made away from the integration points to enable the bad elements to be deleted before an instability leading to an error termination occurs. If nonzero, NFAIL1 can be changed in a restart.</p> <p>EQ.1: print message and delete element. EQ.2: print message, write D3DUMP file, and terminate GT.2: print message and delete element. When NFAIL4 elements are deleted then write D3DUMP file and terminate. These NFAIL4 failed elements also include all shell elements that failed for other reasons than distortion. Before the D3DUMP file is written, NFAIL4 is doubled, so the run can immediately be continued if desired.</p>
PSNFAIL	<p>Optional shell part set ID specifying which part ID's are checked by the NFAIL1 and NFAIL4 options. If zero, all shell part ID's are included.</p>
KEEPCS	<p>Flag to keep the contact segments of failed shell elements in the calculation. The contact segments of the failed shells remain active until a node shared by the segments has no active shells attached. Only then are the segments deleted..</p> <p>EQ.0: Inactive EQ.1: Active</p>

---

<u>VARIABLE</u>	<u>DESCRIPTION</u>
DELFR	Flag to delete shell elements whose neighboring shell elements have failed; consequently, the shell is detached from the structure and moving freely in space. This condition is checked if NFAIL1 or NFAIL4 are nonzero... EQ.0: Inactive EQ.1: Active

**Remarks:**

1. The drill projection is used in the addition of warping stiffness to the Belytschko-Tsay and the Belytschko-Wong-Chiang shell elements. This projection generally works well and is very efficient, but to quote Belytschko and Leviathan:

"The shortcoming of the drill projection is that even elements that are invariant to rigid body rotation will strain under rigid body rotation if the drill projection is applied. On one hand, the excessive flexibility rendered by the 1-point quadrature shell element is corrected by the drill projection, but on the other hand the element becomes too stiff due to loss of the rigid body rotation invariance under the same drill projection".

They later went on to add in the conclusions:

"The projection of only the drill rotations is very efficient and hardly increases the computation time, so it is recommended for most cases. However, it should be noted that the drill projection can result in a loss of invariance to rigid body motion when the elements are highly warped. For moderately warped configurations the drill projection appears quite accurate".

In crashworthiness and impact analysis, elements that have little or no warpage in the reference configuration can become highly warped in the deformed configuration and may affect rigid body rotations if the drill projection is used, i.e., DO NOT USE THE DRILL PROJECTION. Of course it is difficult to define what is meant by "moderately warped". The full projection circumvents these problems but at a significant cost. The cost increase of the drill projection versus no projection as reported by Belytschko and Leviathan is 12 percent and by timings in LS-DYNA, 7 percent, but for the full projection they report a 110 percent increase and in LS-DYNA an increase closer to 50 percent is observed.

In Version 940.xx of LS-DYNA the drill projection was used exclusively, but in one problem the lack of invariance was observed and reported; consequently, the drill projection was replaced in the Belytschko-Leviathan shell with the full projection and the full projection is now optional for the warping stiffness in the Belytschko-Tsay and



---

Belytschko-Wong-Chiang elements. Until this problem occurred, the drill projection seemed okay. In version 950.xx and later versions of LS-DYNA the Belytschko-Leviathan shell is somewhat slower than previously. In general in light of these problems, the drill projection cannot be recommended. For implicit problems, the full projection method is used in the development of the stiffness matrix.

2. All shell parts need not share the same element formulation. A nonzero value of ELFORM, given either in \*SECTION\_SHELL or \*PART\_COMPOSITE, overrides the element formulation specified by THEORY in \*CONTROL\_SHELL.

**\*CONTROL\_SOLID**

Purpose: Provide controls for solid element response.

Card            1            2            3            4            5            6            7            8

Variable	ESORT	FMATRX	NIPTETS	SWLOCL	PSFAIL			
Type	I	I	I	I	I			
Default	0	0	4	2	0			

**This card is optional.**

Card            1            2            3            4            5            6            7            8            9            10

Variable	PM1	PM2	PM3	PM4	PM5	PM6	PM7	PM8	PM9	PM10
Type	I	I	I	I	I	I	I	I	I	I
Default	none	none	none	none	none	none	none	none	none	none

**VARIABLE****DESCRIPTION**

ESORT

Automatic sorting of tetrahedron and pentahedron elements to treat degenerate tetrahedron and pentahedron elements as tetrahedron (formulation 10) and pentahedron (formulation 15) solids, respectively. See \*SECTION\_SOLID.

EQ.0: no sorting (default)

EQ.1: sort tetrahedron to type 10, pentahedron to type 15

EQ.2: sort tetrahedron to type 10, 1-point integrated pentahedron to type 115, fully integrated pentahedron to type 15

EQ.3: same as EQ.1 but also print switched elements in message file

EQ.4: same as EQ.2 but also print switched elements in message file

FMATRX

Default method used in the calculation of the deformation gradient matrix.

EQ.1: Update incrementally in time. This is the default for explicit.

EQ.2: Directly compute F. This is the default for implicit and implicit/explicit switching.

---

<b>VARIABLE</b>	<b>DESCRIPTION</b>
NIPTETS	Number of integration points used in the quadratic tetrahedron elements. Either 4 or 5 can be specified. This option applies to the types 4, 16, and 17 tetrahedron elements.
SWLOCL	Output option for stresses in solid elements used as spot welds with material *MAT_SPOTWELD. EQ.1: Global (default), EQ.2: Local
PSFAIL	Optional solid part set ID specifying which part ID's are checked for negative volumes prior to element processing. If zero, and if ERODE on *CONTROL_TIMESTEP is set to 1, all solid elements are checked each step. The ERODE flag is ignored whenever PSFAIL is defined.
PM1-PM10	Components of a permutation vector for nodes that define the 10-node tetrahedron. The nodal numbering of 10-node tetrahedron elements is somewhat arbitrary. The permutation vector allows other numbering schemes to be used. Unless defined, this permutation vector is not used. PM1-PM10 are unique numbers between 1 to 10 inclusive that reorders the input node ID's for a 10-node tetrahedron into the order used by LS-DYNA.

# \*CONTROL

# \*CONTROL\_SOLUTION

## \*CONTROL\_SOLUTION

Purpose: To specify the analysis solution procedure if thermal only or coupled thermal analysis is performed. Other solutions parameters including the vector length and NaN (not a number) checking can be set.

Card            1            2            3            4            5            6            7            8

Variable	SOLN	NLQ	ISNAN	LCINT				
Type	I	I	I	I				
Default	0	0	0	100				

### VARIABLE

### DESCRIPTION

SOLN	Analysis solution procedure: EQ.0: Structural analysis only, EQ.1: Thermal analysis only, EQ.2: Coupled structural thermal analysis.
NLQ	Define the vector length used in solution. This value must not exceed the vector length of the system which varies based on the machine manufacturer. The default vector length is printed at termination in the MESSAG file.
ISNAN	Flag to check for a NaN in the force and moment arrays after the assembly of these arrays is completed. This option can be useful for debugging purposes. A cost overhead of approximately 2% is incurred when this option is active. EQ.0: No checking, EQ.1: Checking is active.
LCINT	Number of equally spaced intervals used in the load curve discretization.

**\*CONTROL\_SPH**

Purpose: Provide controls relating to SPH (Smooth Particle Hydrodynamics).

Card            1            2            3            4            5            6            7            8

Variable	NCBS	BOXID	DT	IDIM	MEMORY	FORM	START	MAXV
Type	I	I	F	I	I	I	F	F
Default	1	0	1.e20	none	150	0	0.0	1.e15

**Optional Card**

Card            1            2            3            4            5            6            7            8

Variable	CONT	DERIV	INI	ISHOW	IEROD	ICONT		
Type	I	I	I	I	I	I		
Default	0	0	0	0	0	0		

**VARIABLE****DESCRIPTION**

NCBS	Number of time steps between particle sorting.
BOXID	SPH approximations are computed inside a specified BOX. When a particle has gone outside the BOX, it is deactivated. This will save computational time by eliminating particles that no longer interact with the structure.
DT	Death time. Determines when the SPH calculations are stopped.
IDIM	Space dimension for SPH particles: EQ. 3: for 3D problems EQ. 2: for 2D plane strain problems EQ.-2: for 2D axisymmetric problems
MEMORY	Defines the initial number of neighbors per particle (see Remark 1 below).

<b>VARIABLE</b>	<b>DESCRIPTION</b>
FORM	Particle approximation theory: EQ.0: default formulation, EQ.1: renormalization approximation EQ.2: symmetric formulation, EQ.3: symmetric renormalized approximation EQ.4: tensor formulation, EQ.5: fluid particle approximation EQ.6: fluid particle with renormalization approximation, EQ.7: Total Lagrangian formulation EQ.8: Total Lagrangian formulation with renormalization
START	Start time for particle approximation. Particle approximations will be computed when time of the analysis has reached the value defined in START.
MAXV	Maximum value for velocity for the SPH particles. Particles with a velocity greater than MAXV are deactivated.
CONT	Defines the computation of the particle approximation between different SPH parts: EQ.0: Particle approximation is defined (default) EQ.1: Particle approximation is not computed. Different SPH materials will not interact with each other and penetration is allowed unless *DEFINE_SPH_TO_SPH_COUPLING is defined.
DERIV	Time integration type for the smoothing length: EQ.0: $\frac{d}{dt}(h(t)) = \frac{1}{d}h(t)div(v)$ (default), EQ.1: $\frac{d}{dt}(h(t)) = \frac{1}{d}h(t)(div(v))^{1/3}$
INI	Computation of the smoothing length during the initialization: EQ.0: Bucket sort based algorithm (default, very fast). EQ.1: Global computation on all the particles of the model. EQ.2: Based on the mass of the SPH particle.
ISHOW	Display options for SPH elements: EQ.0: Show all SPH particles in LS-PrePost. EQ.1: Exclude deactivated SPH particles in LS-PrePost.
IEROD	Deactivation control for SPH particles: EQ.0: Particles remain active. EQ.1: SPH particles are deactivated and stress states are set to 0 when erosion criteria are satisfied. See Remark 2.

---

<u>VARIABLE</u>	<u>DESCRIPTION</u>
ICONT	Controls contact behavior for deactivated SPH particles: EQ.0: Any contact defined for SPH remains active for deactivated particles. EQ.1: Contact is inactive for deactivated particles.

**Remark:**

1. This variable is for memory allocation of arrays during the initialization phase. It can be positive or negative. If this value is positive, memory allocation is dynamic. During the calculation, some particles can request more neighbors and LS-DYNA will automatically adapt the size of that variable. Default value should apply for most applications. If this value is negative, memory allocation is static. During the calculation only the closest SPH elements will be considered as neighbors. Using this option can avoid memory allocation problems.
2. The erosion criteria which triggers particle deactivation with IEROD=1 may come from the material model, \*MAT\_ADD\_EROSION, or per the ERODE parameter in \*CONTROL\_TIMESTEP. Deactivated particles will remain visible unless ISHOW=1. To disable contact for deactivated particles, set ICONT=1.

**\*CONTROL\_SPOTWELD\_BEAM**

Purpose: Provides factors for scaling the failure force resultants of beam spot welds as a function of their parametric location on the contact segment and the size of the segment. Also, an option is provided to replace beam welds with solid hexahedron element clusters.

Card            1            2            3            4            5            6            7            8

Variable	LCT	LCS	T_ORT	PRTFLG	T_OR	RPBHX	BMSID	ID_OFF
Type	I	I	I	I	I	I	I	I
Default	0	0	0	0	0	0	0	0

**VARIABLE****DESCRIPTION**

LCT	Load curve ID for scaling the response in tension based on the shell element size.
LCS	Load curve ID for scaling the response in shear based on the shell element size.
T_ORT	Table ID for scaling the tension response (and shear response if T_OR=0) based on the location of the beam node relative to the centroid of the shell.
PRTFLG	Set this flag to 1 to print for each spot weld attachment: the beam, node, and shell ID's, the parametric coordinates that define the constraint location, the angle used in the table lookup, and the three scale factors obtained from the load curves and table lookup. See Figure 11.14.
T_OR	Optional table ID for scaling the shear response based on the location of the beam node relative to the centroid of the shell.
RPBHX	Replace each spot weld beam element with a cluster of RPBHX solid elements. RPBHX may be set to 1, 4, or 8. When RPBHX is set to 4 or 8, a table is generated to output the force and moment resultants into the SWFORC file, if this file is active. This table is described by the keyword: *DEFINE_HEX_SPOTWELD_ASSEMBLY. The ID's of the beam elements are used as the cluster spot weld ID's so the ID's in the SWFORC file are unchanged. The beam elements are automatically deleted from the calculation, and the section and material data is automatically changed to be used with solid elements. See Figure 11.15.



<b>VARIABLE</b>	<b>DESCRIPTION</b>
BMSID	Optional beam set ID defining the beam element ID's that are to be converted to hex assemblies. If zero, all spot weld beam elements are converted to hex assemblies. See the keyword, *SET_BEAM_GENERAL for an efficient way of defining beam sets.
ID_OFF	This optional ID offset applies if and only if BMSID is nonzero. Beams, which share part ID's with beams that are converted to hex assemblies, will be assigned new part ID's by adding to the original part ID the value of ID_OFF. If ID_OFF, is zero the new part ID for such beams will be assigned to be larger than the largest part ID in the model.

<b>VARIABLE</b>	<b>DESCRIPTION</b>
LCT	Load curve ID for scaling the response in tension based on the shell element size.
LCS	Load curve ID for scaling the response in shear based on the shell element size.
T_ORT	Table ID for scaling the tension response (and shear response if T_OR=0) based on the location of the beam node relative to the centroid of the shell.
PRTFLG	Set this flag to 1 to print for each spot weld attachment: the beam, node, and shell ID's, the parametric coordinates that define the constraint location, the angle used in the table lookup, and the three scale factors obtained from the load curves and table lookup. See Figure 11.14.
T_OR	Optional table ID for scaling the shear response based on the location of the beam node relative to the centroid of the shell.
RPBHX	Replace each spot weld beam element with a cluster of RPBHX solid elements. RPBHX may be set to 1, 4, or 8. When RPBHX is set to 4 or 8, a table is generated to output the force and moment resultants into the SWFORC file, if this file is active. This table is described by the keyword: *DEFINE_HEX_SPOTWELD_ASSEMBLY. The ID's of the beam elements are used as the cluster spot weld ID's so the ID's in the SWFORC file are unchanged. The beam elements are automatically deleted from the calculation, and the section and material data is automatically changed to be used with solid elements. See Figure 11.15.
BMSID	Optional beam set ID defining the beam element ID's that are to be converted to hex assemblies. If zero, all spot weld beam elements are converted to hex assemblies. See the keyword, *SET_BEAM_

<u>VARIABLE</u>	<u>DESCRIPTION</u>
	GENERAL for an efficient way of defining beam sets.
ID_OFF	This optional ID offset applies if and only if BMSID is nonzero. Beams, which share part ID's with beams that are converted to hex assemblies, will be assigned new part ID's by adding to the original part ID the value of ID_OFF. If ID_OFF, is zero the new part ID for such beams will be assigned to be larger than the largest part ID in the model.

**Remarks:**

The load curves and table provide a means of scaling the response of the beam spot welds to reduce any mesh dependencies for failure model 6 in \*MAT\_SPOTWELD. Figure 11.15 shows such dependencies that can lead to premature spot weld failure. Separate scale factors are calculated for each of the beam's nodes. The scale factors  $s_T$ ,  $s_S$ ,  $s_{OT}$ , and  $s_{OS}$  are calculated using the load curves LCT, LCS, table T\_ORI, and table T\_ORS, respectively, and are introduced in the failure criteria,

$$\left( \frac{s_T s_{OT} \sigma_{rr}}{\sigma_{rr}^F (\dot{\epsilon}_{eff})} \right)^2 + \left( \frac{s_S s_{OS} \tau}{\tau^F (\dot{\epsilon}_{eff})} \right)^2 - 1 = 0$$

If a curve or table is given an ID of 0, its scale factor is set to 1.0. The load curves LCT and LCS are functions of the characteristic size of the shell element used in the time step calculation at the start of the calculation. The orientation table is a function of the spot weld's isoparametric coordinate location on the shell element. A vector  $V=(s,t)$  is defined from the centroid of the shell to the contact point of the beam's node. The arguments for the orientation table are the angle:

$$\Theta = \tan^{-1} \left( \frac{\min(|s|, |t|)}{\max(|s|, |t|)} \right),$$

and the normalized distance  $\bar{d} = d/D = \max(|s|, |t|)$ . See Figure 11.15. The table is periodic over a range of 0 (V aligned with either the s or t axis) to 45 degrees (V is along the diagonal of the element). The table is specified by the angle of V in degrees, ranging from 0 to 45, and the individual curves give the scale factor as a function of the normalized distance of the beam node,  $\bar{d}$ , for a constant angle.

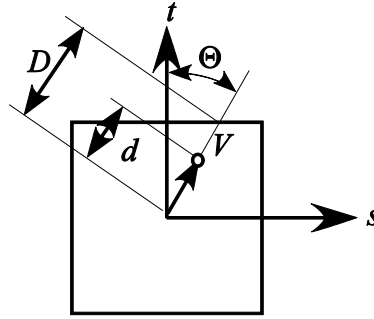


Figure 11.14. Definition of parameters for table definition.

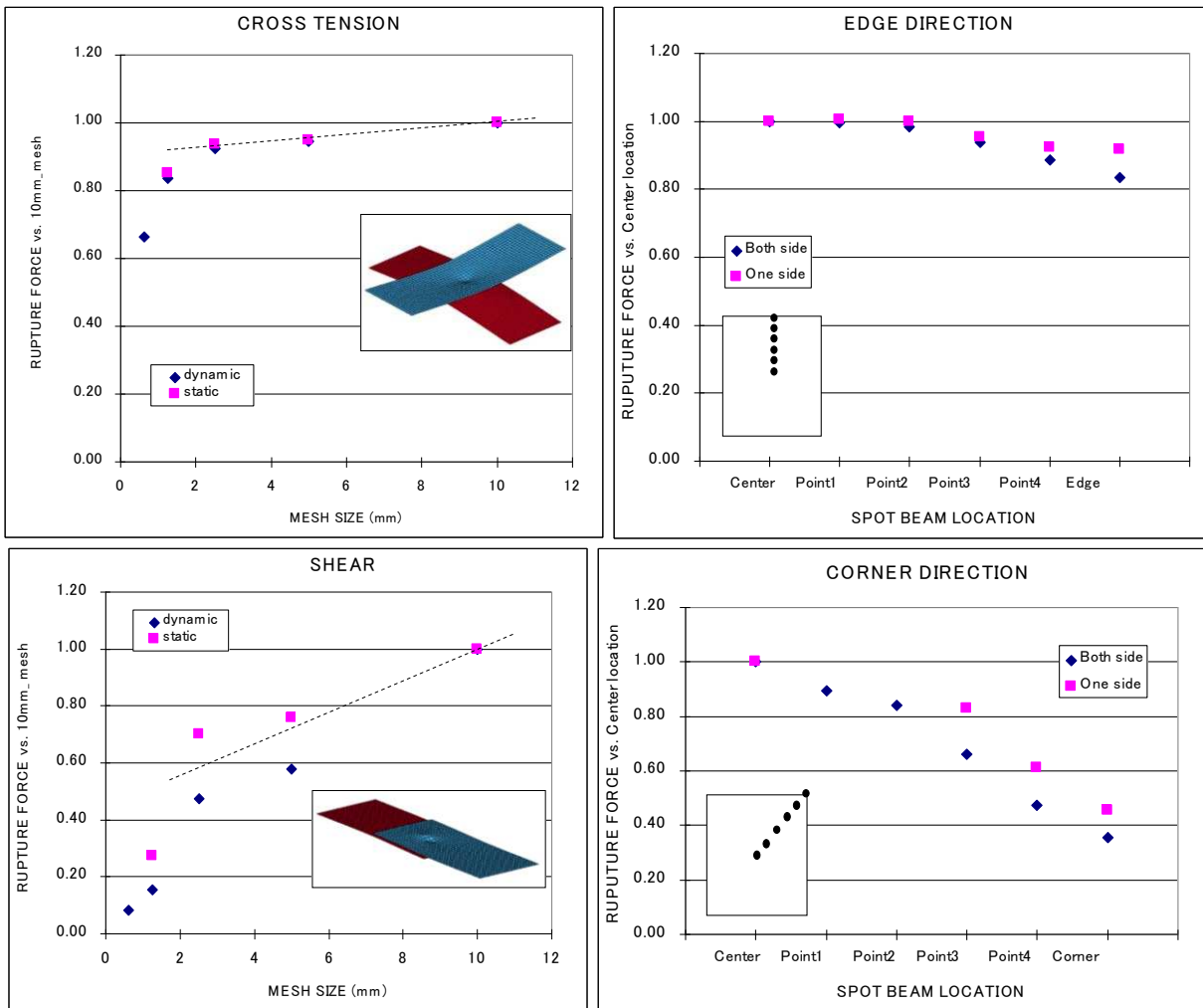


Figure 11.15. The failure force resultants can depend both on mesh size and the location of weld relative to the center of the contact segment.

# \*CONTROL

# \*CONTROL\_START

## \*CONTROL\_START

Purpose: Define the start time of analysis.

Card            1            2            3            4            5            6            7            8

Variable	BEGTIM							
Type	F							

### VARIABLE

### DESCRIPTION

BEGTIM

Start time of analysis (default=0.0).

**\*CONTROL\_STAGED\_CONSTRUCTION**

This control card is used to help break down analyses of construction processes into stages.

Note: This keyword card will be available starting in release 3 of version 971.

Card	1	2	3	4	5	6	7	8
------	---	---	---	---	---	---	---	---

Variable	TSTART	STGS	STGE	ACCEL	FACT	STREF	DORDEL	NOPDEL
Type	F	I	I	F	F	I	I	I
Default	0	0	0	0.0	1.e-6	0	0	0

<u>VARIABLE</u>	<u>DESCRIPTION</u>
TSTART	Time at start of analysis (normally leave blank)
STGS	Construction stage at start of analysis
STGE	Construction stage at end of analysis
ACCEL	Default acceleration for gravity loading
FACT	Default stiffness and gravity factor for parts before they are added
STREF	Reference stage for displacements in d3plot file
DORDEL	Dormant part treatment in d3plot file, see notes. EQ 0: Parts not shown when dormant (flagged as “deleted”), EQ 1: Parts shown normally when dormant.
NOPDEL	Treatment of pressure loads on deleted elements, see notes. EQ 0: Pressure loads automatically deleted, EQ 1: No automatic deletion.

**Remarks:**

See also \*DEFINE\_CONSTRUCTION\_STAGES and \*DEFINE\_STAGED\_CONSTRUCTION\_PART.

The staged construction options offer flexibility to carry out the whole construction simulation in one analysis, or to run it stage by stage. Provided that at least one construction stage is defined

(\*DEFINE\_CONSTRUCTION\_STAGES), a dynain file will be written at the end of each stage (file names are end\_stage001\_dynain, etc). These contain node and element definitions and the stress state; the individual stages can then be re-run without re-running the whole analysis. To do this, make a new input file as follows:

- Copy the original input file, containing \*DEFINE\_CONSTRUCTION\_STAGES and \*DEFINE\_STAGED\_CONSTRUCTION\_PART.
- Delete node and element definitions as these will be present in the dynain file (\*NODE, \*ELEMENT\_SOLID, \*ELEMENT\_SHELL, and \*ELEMENT\_BEAM).
- Delete any \*INITIAL cards; the initial stresses in the new analysis will be taken from the dynain file.
- On \*CONTROL\_STAGED\_CONSTRUCTION set STGS to start at the desired stage
- Add an \*INCLUDE statement referencing, for example, end\_stage002\_dynain if starting the new analysis from Stage 3.
- Move or copy the dynain file into the same directory as the new input file.

When STGS is >1 the analysis starts at a non-zero time (the start of stage STGS). In this case a dynain file must be included to start the analysis from the stress state at the end of the previous stage. The end time for stage STGE overrides the termination time on \*CONTROL\_TERMINATION. A new dynain file will be written at the end of all stages from STGS to STGE.

ACCEL and FACT are used with \*STAGED\_CONSTRUCTION\_PART for simpler input definition of the parts present at different construction stages.

If STGS>1 and elements have been deleted in a previous stage, these elements will be absent from the new analysis and should not be referred to (e.g. \*DATABASE\_HISTORY\_SOLID) in the new input file.

TSTART can be used to set a non-zero start time (again, assuming a compatible dynain file is included). This option is used only if construction stages have not been defined.

STREF allows the user to set a construction stage at the start of which displacements are considered to be zero – e.g. so that initial analysis stages that achieve a pre-construction equilibrium do not contribute to contour plots of displacement. The current coordinates are not modified, only the “initial geometry” coordinates in the d3plot file. If this analysis starts from a stage later than STREF, the reference geometry will be taken from the dynain file that was written at the end of the stage previous to STREF – this dynain file must be in the same directory as the current model for this process to occur. This feature is not available in MPP.

DORDEL: By default, parts for which \*DEFINE\_STAGED\_CONSTRUCTION\_PART is defined are flagged as “deleted” in the d3plot file at time-states for which the part is not active (i.e. STGA has not yet been reached). Parts that are deleted because STGR has been reached are

also flagged as “deleted”. When animating the results, the parts should appear as they become active and disappear as they are deleted. If DORDEL is non-zero, inactive parts (before STGA) are shown normally. The parts are still shown as deleted after STGR is reached.

NOPDEL: By default, pressure load “segments” are automatically deleted by LS-DYNA if they share all four nodes with a deleted solid or shell element. In staged construction, the user may want to apply pressure load to the surface of an element (A) that is initially shared with an element (B), where B is deleted during the calculation. For example, B may be in a layer of soil that is excavated, leaving A as the new top surface. The default scheme would delete the pressure segment when B is removed, despite the fact that A is still present. NOPDEL instructs LS-DYNA to skip the automatic deletion of pressure segments, irrespective of whether the elements have been deleted due to staged construction or material failure. The user must then ensure that pressure loads are not applied to nodes no longer supported by an active element.

**\* CONTROL\_STEADY\_STATE\_ROLLING**

Card            1            2            3            4            5            6            7            8

Variable	IMASS	LCDMU	LCDMUR	IVEL	SCL_K			
Type	I	I	I	I	I			
Default	0	0	0	0				

**VARIABLE****DESCRIPTION**

IMASS	Inertia switching flag EQ.0: include inertia during an implicit dynamic simulation. EQ.1: treat steady state rolling subsystems as quasi-static during implicit dynamic simulations.
LCDMU	Optional load curve for scaling the friction forces in contact.
LCDMUR	Optional load curve for scaling the friction forces in contact during dynamic relaxation. If LCDMUR isn't specified, LCDMU is used.
IVEL	Velocity switching flag. EQ.0: eliminate the steady state rolling body forces and set the velocities of the nodes after dynamic relaxation. EQ.1: keep the steady state rolling body forces after dynamic relaxation instead of setting the velocities.
SCL_K	Scale factor for the friction stiffness during contact loading and unloading. The default values are 1.0 and 0.01 for explicit and implicit, respectively. Any scaling applied here applies only to contact involving the subsystem of parts defined for steady state rolling.

**Remarks:**

1. Treating the steady state rolling subsystems as quasi-static during an implicit simulation may eliminate vibrations in the system that are not of interest and is generally recommended.
2. Ramping up the friction by scaling it with LCDMU and LCDMUR may improve the convergence behavior of implicit calculations. The values of the load curves should be 0.0 at initial contact and ramp up smoothly to a value of 1.0.



- 
3. After dynamic relaxation, the default behavior is to initialize the nodes with the velocities required to generate the body forces on elements and remove the body forces. This initialization is skipped, and the body forces retained, after dynamic relaxation if IVEL=1.
  4. The friction model in contact is similar to plasticity, where there is an elastic region during the loading and unloading of the friction during contact. The elastic stiffness is scaled from the normal contact stiffness. For implicit calculations, the default scale factor is 0.01, which results in long periods of time being required to build the friction force, and, in some cases, oscillations in the contact forces. A value between 10 and 100 produces smoother solutions and a faster build-up and decay of the friction force as the tire velocity or slip angle is varied, allowing a parameter study to be performed in a single run.

**\*CONTROL\_STRUCTURED\_{OPTION}**

Available options include:

**<BLANK>**

**TERM**

Purpose: Write out an LS-DYNA structured input deck that is largely or wholly equivalent to the keyword input deck. Not all LS-DYNA features are supported in structured input format. The name of this structured file is “dyna.str”. Some data such as load curve numbers will be output in an internal numbering system. If the TERM option is activated termination will occur after the structured input file is written. This option is useful in debugging especially if problems occur in reading the input file.

**\*CONTROL\_SUBCYCLE**

Purpose: Control time step subcycling. This feature is described in the LS-DYNA Theory Manual, Section 21.2, and its use may be detrimental in cases of vectorized computation. This keyword activates subcycling. The use of mass scaling to preserve a reasonable time step size often works better than subcycling. To use mass scaling set the input parameter, DT2MS, to the negative value of the minimum acceptable time step size. See the keyword, \*CONTROL\_TIMESTEP.

# \*CONTROL

# \*CONTROL\_TERMINATION

## \*CONTROL\_TERMINATION

Purpose: Stop the job.

Card            1            2            3            4            5            6            7            8

Variable	ENDTIM	ENDCYC	DTMIN	ENDENG	ENDMAS	NOSOL		
Type	F	I	F	F	F	I		
Default	0.0	0	0.0	0.0	0.0	0		
Remarks	1		2					

### VARIABLE

### DESCRIPTION

ENDTIM	Termination time. Mandatory.
ENDCYC	Termination cycle. The termination cycle is optional and will be used if the specified cycle is reached before the termination time. Cycle number is identical with the time step number.
DTMIN	Reduction (or scale) factor for initial time step size to determine minimum time step, TSMIN. $TSMIN=DTSTART*DTMIN$ where DTSTART is the initial step size determined by LS-DYNA. When TSMIN is reached, LS-DYNA terminates with a restart dump.
ENDENG	Percent change in energy ratio for termination of calculation. If undefined, this option is inactive.
ENDMAS	Percent change in the total mass for termination of calculation. This option is relevant if and only if mass scaling is used to limit the minimum time step size, see *CONTROL_TIMESTEP variable name "DT2MS".
NOSOL	Flag for a non-solution run, i.e. normal termination directly after initialization. EQ.0: off (default), EQ.1: on.

### Remarks:

1. Termination by displacement may be defined in the \*TERMINATION section.

2. If the erosion flag on \*CONTROL\_TIMESTEP is set (ERODE=1), then the thick shell elements and solid elements with time steps falling below TSMIN will be eroded.

# \*CONTROL

# \*CONTROL\_THERMAL\_NONLINEAR

## \*CONTROL\_THERMAL\_NONLINEAR

Purpose: Set parameters for a nonlinear thermal or coupled structural/thermal analysis. The control card, \*CONTROL\_SOLUTION, is also required.

Card            1            2            3            4            5            6            7            8

Variable	REFMAX	TOL	DCP	LUMPBC	THLSTL	NLTHPR	PHCHPN	
Type	I	F	F	I	F	I	F	
Default	10	1.e-04	1.0 / 0.5	0	0.	0	100.	

### VARIABLE

### DESCRIPTION

REFMAX	Maximum number of matrix reformations per time step: EQ.0: set to 10 reformations.
TOL	Convergence tolerance for temperature: EQ.0.0: set to 1000 * machine roundoff.
DCP	Divergence control parameter: steady state problems $0.3 \leq DCP \leq 1.0$ default 1.0 transient problems $0.0 < DCP \leq 1.0$ default 0.5
LUMPBC	Lump enclosure radiation boundary condition: EQ.0: off (default) EQ.1: on
THLSTL	Line search convergence tolerance: EQ.0.0: No line search GT.0.0: Line search convergence tolerance
NLTHPR	Thermal nonlinear print out level: EQ.0: No print out EQ.1: 1 Print convergence parameters during solution of nonlinear system
PHCHPN	Phase change penalty parameter: EQ.0.0: Set to default value 100. GT.0.0: Penalty to enforce constant phase change temperature

**\*CONTROL\_THERMAL\_SOLVER**

Purpose: Set options for the thermal solution in a thermal only or coupled structural-thermal analysis. The control card, \*CONTROL\_SOLUTION, is also required.

Card 1            1            2            3            4            5            6            7            8

Variable	ATYPE	PTYPE	SOLVER	CGTOL	GPT	EQHEAT	FWORK	SBC
Type	I	I	I	F	I	F	F	F
Default	0	0	3	1.0e-04	8	1.	1.	0.

**Optional Card (Define if SOLVER = 11, 12, 13, 14, 15 or 16)**

Card 2            1            2            3            4            5            6            7            8

Variable	MSGLVL	MAXITR	ABSTOL	RELTOL	OMEGA			TSF
Type	I	I	F	F	F			F
Default	0	500	1.0e-10	1.0e-04	1.0 or 0.			1.

<u>VARIABLE</u>	<u>DESCRIPTION</u>
ATYPE	Thermal analysis type: EQ.0: Steady state analysis, EQ.1: transient analysis.
PTYPE	Thermal problem type: (see *CONTROL_THERMAL_NONLINEAR if no-zero) EQ.0: linear problem, EQ.1: nonlinear problem with material properties evaluated at gauss point temperature. EQ.2: nonlinear problem with material properties evaluated at element average temperature.

<b>VARIABLE</b>	<b>DESCRIPTION</b>
SOLVER	Thermal analysis solver type: EQ.1:using solver 11 (enter -1 to use the old ACTCOL solver), EQ.2:nonsymmetric direct solver, EQ.3:diagonal scaled conjugate gradient iterative (default), EQ.4:incomplete choleski conjugate gradient iterative, EQ.5:nonsymmetric diagonal scaled bi-conjugate gradient EQ.11:symmetric direct solver (recommended over #1), For MPP executions: EQ.11:symmetric direct solver, EQ.12:diagonal scaling (default for mpp) conjugate gradient iterative, EQ.13:symmetric Gauss-Siedel conjugate gradient iterative, EQ.14:SSOR conjugate gradient iterative, EQ.15: ILDLT0 (incomplete factorization) conjugate gradient iterative, EQ.16:modified ILDLT0 (incomplete factorization) conjugate gradient iterative.
CGTOL	Convergence tolerance for SOLVER = 3 and 4. EQ.0.0:use default value 1.e-04 single or 1.e-06 double precision
GPT	Number of Gauss points to be used in the solid elements: EQ.0.0:use default value 8, EQ.1.0:one point quadrature is used.
EQHEAT	Mechanical equivalent of heat (e.g., 1 J / N m). EQ.0.0:use default value 1.0, LT.0.0:designates a load curve number for EQHEAT versus time.
FWORK	Fraction of mechanical work converted into heat. EQ.0.0:use default value 1.0.
SBC	Stefan Boltzmann constant. Value is used with enclosure radiation surfaces, see *BOUNDARY_RADIATION_..... LT.0.0:use a smoothing algorithm when calculating view factors to force the row sum=1.
MSGLVL	Output message level (For SOLVER > 10) EQ.0:no output (default), EQ.1:summary information, EQ.2:detailed information, use only for debugging.
MAXITR	Maximum number of iterations. For SOLVER >11. EQ.0:use default value 500,



---

<u>VARIABLE</u>	<u>DESCRIPTION</u>
ABSTOL	Absolute convergence tolerance. For SOLVER >11. EQ.0.0:use default value 1.e-10
RELTOL	Relative convergence tolerance. Replaces CGTOL for SOLVER >11. EQ.0.0:use default value 1.e-06
OMEGA	Relaxation parameter omega for SOLVER 14 and 16. EQ.0.0:use default value 1.0 for Solver 14, use default value 0.0 for Solver 16.
TSF	Thermal Speedup Factor – this factor multiplies all thermal velocity terms (i.e., those with 1/sec) for artificial time scaling for metal stamping when the puch speed is artificially increased.

**Remarks:**

1. Solvers 1, 2, 3 and 4 are only for SMP environments. Solvers 11, 12, 13, 14, 15 and 16 are for SMP and MPP.
2. Solver 11 is the preferred direct solver. Solver 11 uses sparse matrix storage and requires much less memory than Solver 1.
3. Use of a direct solver (e.g., SOLVER = 1, 2 or 11) is usually less efficient than using an iterative solver (SOLVER = 3, 4, 12, 13, 14, 15 or 16). Consider using a direct solver to get the model running and then switch to an iterative solver to decrease execution time (particularly for large models). Direct solvers should be used when experiencing slow or no convergence.
4. For transient problems, diagonal scaling conjugate gradient (SOLVER = 3 or 12) should be adequate.
5. For steady state problems, convergence may be slow or unacceptable, so consider using direct solver (SOLVER = 1, 2 or 11) or a more powerful preconditioner (SOLVER = 4, 13, 14, 15 or 16).
6. Solver 13 (symmetric Gauss-Seidel) and solver 14 (SSOR) are related. When OMEGA = 1, solver 14 is equivalent to solver 13. The optimal omega value for SSOR is problem dependent but lies between 1 and 2.
7. Solver 15 (incomplete LDLT0) and solver 16 (modified incomplete LDLT0) are related. Both are no-fill factorizations that require one extra n-vector of storage. The sparsity pattern of the preconditioner is exactly the same as that of the thermal stiffness matrix. Solver 16 uses the relaxation parameter OMEGA. The optimal OMEGA value is problem dependent, but lies between 0 and 1.

8. Solvers 12, 13, 14, 15 and 16 terminate the iterative solution process when (1) the number of iterations exceeds MAXITR or (2) the 2-norm of the residual drops below  $ABSTOL + RELTOL * 2\text{-norm of the initial residual}$ .

**\*CONTROL\_THERMAL\_TIMESTEP**

Purpose: Set time step controls for the thermal solution in a thermal only or coupled structural/thermal analysis. Also \*CONTROL\_SOLUTION, \*CONTROL\_THERMAL\_SOLVER needed.

Card            1            2            3            4            5            6            7            8

Variable	TS	TIP	ITS	TMIN	TMAX	DTEMP	TSCP	LCTS
Type	I	F	F	F	F	F	F	I
Default	0	0.5	none	-	-	1.0	0.5	0

**VARIABLE****DESCRIPTION**

TS	Time step control: EQ.0: fixed time step, EQ.1: variable time step (may increase or decrease).
TIP	Time integration parameter: EQ.0.0: set to 0.5 - Crank-Nicholson scheme, EQ 1.0: fully implicit.
ITS	Initial thermal time step
TMIN	Minimum thermal time step: EQ.0.0: set to structural explicit time step.
TMAX	Maximum thermal time step: EQ.0.0: set to 100 * structural explicit time step.
DTEMP	Maximum temperature change in each time step above which the thermal time step will be decreased: EQ.0.0: set to a temperature change of 1.0.
TSCP	Time step control parameter. The thermal time step is decreased by this factor if convergence is not obtained. $0 < TSCP < 1.0$ : EQ.0.0: set to a factor of 0.5.
LCTS	LCTS designates a load curve number which defines data pairs of (thermal time breakpoint, new time step). The time step will be adjusted to hit the time breakpoints exactly. After the time breakpoint, the time step will be set to the 'new time step' ordinate value in the load curve.

# \*CONTROL

# \*CONTROL\_TIMESTEP

## \*CONTROL\_TIMESTEP

Purpose: Set structural time step size control using different options.

Card 1            1            2            3            4            5            6            7            8

Variable	DTINIT	TSSFAC	ISDO	TSLIMIT	DT2MS	LCTM	ERODE	MS1ST
Type	F	F	I	F	F	I	I	I
Default	-	0.9/0.67	0	0.0	0.0	0	0	0

**This card is optional.**

Card 2            1            2            3            4            5            6            7            8

Variable	DT2MSF	DT2MSL C	IMSCL			RMSCL		
Type	F	I	I			F		
Default	not used	not used	0			0.0		

### VARIABLE

### DESCRIPTION

DTINIT

Initial time step size:  
EQ.0.0: LS-DYNA determines initial step size.

TSSFAC

Scale factor for computed time step (old name SCFT). See Remark 1 below. (Default = .90; if high explosives are used, the default is lowered to .67).

---

VARIABLE	DESCRIPTION
ISDO	<p>Basis of time size calculation for 4-node shell elements. 3-node shells use the shortest altitude for options 0,1 and the shortest side for option 2. This option has no relevance to solid elements, which use a length based on the element volume divided by the largest surface area.</p> <p>EQ.0: characteristic length=area/(minimum of the longest side or the longest diagonal).</p> <p>EQ.1: characteristic length=area/(longest diagonal).</p> <p>EQ.2: based on bar wave speed and MAX [shortest side, area/(minimum of the longest side or the longest diagonal)]. THIS LAST OPTION CAN GIVE A MUCH LARGER TIME STEP SIZE THAT CAN LEAD TO INSTABILITIES IN SOME APPLICATIONS, ESPECIALLY WHEN TRIANGULAR ELEMENTS ARE USED.</p> <p>EQ.3: time step size is based on the maximum eigenvalue. This option is okay for structural applications where the material sound speed changes slowly. The cost related to determining the maximum eigenvalue is significant, but the increase in the time step size often allows for significantly shorter run times without using mass scaling.</p>
TSLIMIT	<p>Shell element minimum time step assignment, TSLIMIT. When a shell controls the time step, element material properties (moduli <u>not</u> masses) will be modified such that the time step does not fall below the assigned step size. This option is applicable only to shell elements using material models: *MAT_PLASTIC_KINEMATIC, *MAT_POWER_LAW_PLASTICITY, *MAT_STRAIN_RATE_DEPENDENT_PLASTICITY, *MAT_PIECEWISE_LINEAR_PLASTICITY. This so-called stiffness scaling option is NOT recommended. The DT2MS option below applies to all materials and element classes and is preferred. If both TSLIMIT and DT2MS below are active and if TSLIMIT is input as a positive number, then TSLIMIT is set to 1.E-18, which makes it inactive. If TSLIMIT is negative and less than  DT2MS , then  TSLIMIT  is applied prior to the mass being scaled. If  DT2MS  exceeds the magnitude of TSLIMIT, then TSLIMIT is set to 1.E-18.</p>

<b>VARIABLE</b>	<b>DESCRIPTION</b>
DT2MS	Time step size for mass scaled solutions, DT2MS. Positive values are for quasi-static analyses or time history analyses where the inertial effects are insignificant. Default = 0.0. If negative, TSSFAC* DT2MS  is the minimum time step size permitted and mass scaling is done if and only if it is necessary to meet the Courant time step size criterion. This latter option can be used in transient analyses if the mass increases remain insignificant. See *CONTROL_TERMINATION variable name "ENDMAS". WARNING: Superelements, *ELEMENT_DIRECT_MATRIX_INPUT, are not mass scaled; consequently, DT2MS does not affect their time step size. In this case an error termination will occur, and DT2MS will need to be reset to a smaller value.
LCTM	Load curve ID that limits the maximum time step size (optional). This load curve defines the maximum time step size permitted versus time. If the solution time exceeds the final time value defined by the curve the computed step size is used. If the time step size from the load curve is exactly zero, the computed time step size is also used.
ERODE	Erosion flag for Solid, T-Shell and SPH elements when TSMIN (see *CONTROL_TERMINATION) is reached. If this flag is not set the calculation will terminate. For SPH elements, particles will be deactivated when TSMIN is reached For solid elements the PSFAIL option is available and can reduce CPU time, see *CONTROL_SOLID. EQ.0: no, EQ.1: yes. If ERODE=1, and TSMIN>0 (See *CONTROL_TERMINATION), all solid elements are checked at the beginning of element processing to check for negative volumes. The solid elements, which are found with negative volumes, are eroded and the calculation continues.
MS1ST	Limit mass scaling to the first step and fix the mass vector according to the time steps once. The time step will not be fixed but may drop during the calculation from the specified minimum: EQ.0: no, EQ.1: yes.
DT2MSF	Reduction (or scale) factor for initial time step size to determine the minimum time step size permitted. Mass scaling is done if it is necessary to meet the Courant time step size criterion. If this option is used DT2MS= -DT2MSF multiplied by the initial time step size, $\Delta t$ , before $\Delta t$ is scaled by TSSFAC. This option is active if and only if DT2MS=0 above.

VARIABLE	DESCRIPTION
DT2MSLC	Load curve specifying DT2MS as a function of time during the explicit solutions phase. The load curve can only be used for increasing the magnitude of DT2MS. Consequently, the magnitude of DT2MS is taken as the maximum of the current value and the value from the load curve.
IMSCL	Flag for selective mass scaling if and only if mass scaling active. Selective mass scaling does not scale the rigid body mass and is therefore more accurate. Since it is memory and CPU intensive, it should be applied only to small finely meshed parts. This option is available starting with the third revision of version 971. EQ.0: no selective mass scaling. EQ.1: all parts undergo selective mass scaling. LT.0: recommended.  IMSCL  is the part set ID of the parts that undergo selective mass scaling; all other parts are mass scaled the usual way.
RMSCL	Flag for using rotational option in selective mass scaling EQ.0.: Only translational inertia are selectively mass scaled NE.0.: Both translational and rotational inertia are selectively mass scaled

**Remarks:**

1. During the solution we loop through the elements and determine a new time step size by taking the minimum value over all elements.

$$\Delta t^{n+1} = TSSFAC \cdot \min \{ \Delta t_1, \Delta t_2, \dots, \Delta t_N \}$$

where N is the number of elements. The time step size roughly corresponds to the transient time of an acoustic wave through an element using the shortest characteristic distance. For stability reasons the scale factor TSSFAC is typically set to a value of .90 (default) or some smaller value. To decrease solution time we desire to use the largest possible stable time step size. Values larger than .90 will often lead to instabilities. Some comments follow:

- The sound speed in steel and aluminum is approximately 5mm per microsecond; therefore, if a steel structure is modeled with element sizes of 5mm, the computed time step size would be 1 microsecond. Elements made from materials with lower sound speeds, such as foams, will give larger time step sizes. Avoid excessively small elements and be aware of the effect of rotational inertia on the time step size in the Belytschko beam element. Sound speeds differ for each material, for example, consider:

AIR	331 m/s
WATER	1478

STEEL	5240
TITANIUM	5220
PLEXIGLAS	2598

- Model stiff components with rigid bodies, not by scaling Young's modulus which can substantially reduce the time step size.
- The altitude of the triangular element should be used to compute the time step size. Using the shortest side is okay only if the calculation is closely examined for possible instabilities. This is controlled by parameter ISDO.
- In the explicit time integration context and in contrast to conventional mass scaling, selective mass scaling (SMS) is a well thought out scheme that not only reduces the number of simulation cycles but that also does not significantly affect the dynamic response of the system under consideration. The drawback is that a linear system of equations must be solved in each time step for the accelerations, in this implementation a preconditioned conjugate gradient method (PCG) is used. An unfortunate consequence of this choice of solver is that the efficiency will worsen when attempting large time steps since the condition number of the assembled mass matrix increases with the added mass. Therefore caution should be taken when choosing the desired time step size. For large models it is also recommended to only use SMS on critical parts since it is otherwise likely to slow down execution, once again the bottle neck being the solution of the linear system of equations. Finally, one should be aware that all constraints and boundary conditions available in LS-DYNA may not be supported for SMS but are continuously implemented when requested by users. Up to date and in brief, the following features are supported in this context

Pointwise nodal constraints in global and local directions

Prescribed motion in global and local directions

Adaptivity

Rigid walls

Deformable elements merged with rigid bodies

Constraint contacts and spotwelds

By default, only the translational dynamic properties are treated. This means that only rigid body translation will be unaffected by the mass scaling imposed. There is an option to also properly treat rigid body rotation in this way, this is invoked by flagging the parameter RMSCL. A penalty in computational expense is incurred but the results could be improved if rotations are dominating the simulation.



**\*CONTROL\_UNITS**

Purpose: Specify the user units for the current keyword input deck. This does not provide any mechanism for automatic conversion of units of any entry in the keyword input deck. It is intended to be used for several purposes, but currently only for the situation where an external database in another set of units will be loaded and used in the simulation. In this case, **\*CONTROL\_UNITS** provides the information necessary to convert the external data into internal units (see **\*CHEMISTRY\_CONTROL** for such external databases).

If the needed unit is not one of the predefined ones listed for use on the first card, then the second optional card is used to define that unit. Any non-zero scales that are entered on optional card 2 override what is specified on the first card. These scales are given in terms of the default units on card 1. For instance, if 3600.0 is given in the second 20 character field on the optional second card (TIME\_SCALE), then 'hour' is the time unit (3600 seconds).

Card 1            1            2            3            4            5            6            7            8

Variable	LENGTH	TIME	MASS	TEMP				
Type	A	A	A	A				
Default	m	sec	kg	K				

**Optional Card only used when a new unit needs to be defined:**

Card            1            2            3            4            5            6            7            8

Variable	LENGTH_SCALE	TIME_SCALE	MASS_SCALE	
Type	F	F	F	
Default	1.0	1.0	1.0	

---

<b>VARIABLE</b>	<b>DESCRIPTION</b>
LENGTH	Length units: EQ. m (meter) (default) EQ. mm (millimeter) EQ. cm (centimeter) EQ. in (inch) EQ. ft (foot)
TIME	Time units: EQ. sec (second) (default) EQ. ms (msec, millisc) EQ. micro_s (microsec)
MASS	Mass units: EQ. kg (kilogram) (default) EQ. g (gram) EQ. mg (milligram) EQ. lb (pound) EQ. slug: pound-sec**2/foot EQ. slinch: pound-sec**2/inch EQ. mtrc_ton (metric_ton)
TEMP	Temperature units: EQ. K (Kelvin) (default) EQ. C (Celsius) EQ. F (Fahrenheit) EQ. R (Rankine)
LENGTH_SCALE	Number of meters in the length unit for the input deck
TIME_SCALE	Number of seconds in the time unit for the input deck
MASS_SCALE	Number of kilograms in the mass unit for the input deck

# **\*DAMPING**

The Keyword options in this section in alphabetical order are:

**\*DAMPING\_FREQUENCY\_RANGE**

**\*DAMPING\_GLOBAL**

**\*DAMPING\_PART\_MASS**

**\*DAMPING\_PART\_STIFFNESS**

**\*DAMPING\_RELATIVE**

# \*DAMPING

## \*DAMPING\_FREQUENCY\_RANGE

### \*DAMPING\_FREQUENCY\_RANGE

Purpose: This feature provides approximately constant damping (i.e. frequency-independent) over a range of frequencies.

Card            1            2            3            4            5            6            7            8

Variable	CDAMP	FLOW	FHIGH	PSID				
Type	F	F	F	I				
Default	0.0	0.0	0.0	0				

#### VARIABLE

#### DESCRIPTION

CDAMP	Damping in fraction of critical.
FLOW	Lowest frequency in range of interest (cycles per unit time, e.g. Hz if time unit is seconds)
FHIGH	Highest frequency in range of interest (cycles per unit time, e.g. Hz if time unit is seconds)
PSID	Part set ID. The requested damping is applied only to the parts in the set. If PSID = 0, the damping is applied to all parts except those referred to by other *DAMPING_FREQUENCY_RANGE cards.

#### Remarks:

This feature provides approximately constant damping (i.e. frequency-independent) over a range of frequencies  $F_{low} < F < F_{high}$ . It is intended for small damping ratios (e.g.  $< 0.05$ ) and frequency ranges such that  $F_{high}/F_{low}$  is in the range 10-300. The drawback to this method of damping is that it reduces the dynamic stiffness of the model, especially at low frequencies. This effect is predictable: the natural frequencies of modes close to  $F_{low}$  are reduced by 3% for a damping ratio of 0.01 and  $F_{high}/F_{low}$  in the range 10-30. Near  $F_{high}$  the error is between zero and one third of the error at  $F_{low}$ . Estimated frequency errors are shown in the next table.

Frequency	$F_{\text{high}}/F_{\text{low}}$			
		3 to 30	30 to 300	300 to 3000
Error at $F_{\text{low}}$				
Damping	0.01	3%	4.5%	6%
Ratio	0.02	6%	9%	12%
	0.04	12%	18%	24%

It is recommended that the elastic stiffnesses in the model be increased slightly to account for this, e.g. for 0.01 damping across a frequency range of 30 to 600Hz, the average error across the frequency range is about 2%. Increase the stiffness by  $(1.02)^2$ , i.e. by 4%.

# \*DAMPING

# \*DAMPING\_GLOBAL

## \*DAMPING\_GLOBAL

Purpose: Define mass weighted nodal damping that applies globally to the nodes of deformable bodies and to the mass center of the rigid bodies.

Card            1            2            3            4            5            6            7            8

Variable	LCID	VALDMP	STX	STY	STZ	SRX	SRY	SRZ
Type	I	F	F	F	F	F	F	F
Default	0	0.0	0.0	0.0	0.0	0.0	0.0	0.0
Remarks	1		2	2	2	2	2	2

### VARIABLE

### DESCRIPTION

LCID	Load curve ID which specifies the system damping constant: EQ.0: a constant damping factor as defined by VALDMP is used, EQ.n: system damping is given by load curve n. The damping force applied to each node is $f=-d(t) mv$ , where $d(t)$ is defined by load curve n.
VALDMP	System damping constant, $D_s$ (this option is bypassed if the load curve number defined above is non zero).
STX	Scale factor on global x translational damping forces.
STY	Scale factor on global y translational damping forces.
STZ	Scale factor on global z translational damping forces.
SRX	Scale factor on global x rotational damping moments.
SRY	Scale factor on global y rotational damping moments.
SRZ	Scale factor on global z rotational damping moments.

### Remarks:

1. This keyword is also used for the restart, see \*RESTART.

2. If STX=STY=STZ=SRX=SRY=SRZ=0.0 in the input above, all six values are defaulted to unity.

With mass proportional system damping the acceleration is computed as:

$$a^n = M^{-1} \left( P^n - F^n - F_{damp}^n \right)$$

where,  $M$  is the diagonal mass matrix,  $P^n$  is the external load vector,  $F^n$  is the internal load vector, and  $F_{damp}^n$  is the force vector due to system damping. This latter vector is defined as:

$$F_{damp}^n = D_s m v$$

The best damping constant for the system is usually some value approaching the critical damping factor for the lowest frequency mode of interest.

$$(D_s)_{critical} = 2\omega_{min}$$

The natural frequency  $\omega_{min}$  (given in radians per unit time) is generally taken as the fundamental frequency of the structure. This frequency can be determined from an eigenvalue analysis or from an undamped transient analysis. Note that this damping applies to both translational and rotational degrees of freedom. Also note that mass proportional damping will damp rigid body motion as well as vibration.

Energy dissipated by through mass weighted damping is reported as system damping energy in the ASCII file GLSTAT. This energy is computed whenever system damping is active.

# \*DAMPING

## \*DAMPING\_PART\_MASS

### \*DAMPING\_PART\_MASS\_{OPTION}

OPTION specifies that a part set ID is given with the single option:

#### SET

If not used a part ID is assumed.

Purpose: Define mass weighted damping by part ID. Parts may be either rigid or deformable. In rigid bodies the damping forces and moments act at the center of mass.

Card 1            1            2            3            4            5            6            7            8

Variable	PID/PSID	LCID	SF	FLAG				
Type	I	I	F	I				
Default	0	0	1.0	0				

**(This card is optional and is read if and only if FLAG=1. If this card is not read STX, STY, STZ, SRX, SRY, and SRZ default to unity.)**

Card 2            1            2            3            4            5            6            7            8

Variable	STX	STY	STZ	SRX	SRY	SRZ		
Type	F	F	F	F	F	F		
Default	0.0	0.0	0.0	0.0	0.0	0.0		

#### VARIABLE

#### DESCRIPTION

PID/PSID	Part ID, see *PART or part set ID, see *SET_PART.
LCID	Load curve ID which specifies system damping for parts.
SF	Scale factor for load curve. This allows a simple modification of the load curve values.
FLAG	Set this flag to unity if the global components of the damping forces require separate scale factors.



<u>VARIABLE</u>	<u>DESCRIPTION</u>
STX	Scale factor on global x translational damping forces.
STY	Scale factor on global y translational damping forces.
STZ	Scale factor on global z translational damping forces.
SRX	Scale factor on global x rotational damping moments.
SRY	Scale factor on global y rotational damping moments.
SRZ	Scale factor on global z rotational damping moments.

**Remarks:**

Mass weighted damping damps all motions including rigid body motions. For high frequency oscillatory motion stiffness weighted damping may be preferred. With mass proportional system damping the acceleration is computed as:

$$a^n = M^{-1} (P^n - F^n - F_{damp}^n)$$

where,  $M$  is the diagonal mass matrix,  $P^n$  is the external load vector,  $F^n$  is the internal load vector, and  $F_{damp}^n$  is the force vector due to system damping. This latter vector is defined as:

$$F_{damp}^n = D_s m v$$

The best damping constant for the system is usually based on the critical damping factor for the lowest frequency mode of interest. Therefore,

$$D_s = 2 \omega_{min}$$

is recommended where the natural frequency (given in radians per unit time) is generally taken as the fundamental frequency of the structure. The damping is applied to both translational and rotational degrees of freedom. The component scale factors can be used to limit which global components see damping forces.

Energy dissipated by through mass weighted damping is reported as system damping energy in the ASCII file GLSTAT. This energy is computed whenever system damping is active.

# \*DAMPING

# \*DAMPING\_PART\_STIFFNESS

## \*DAMPING\_PART\_STIFFNESS\_{OPTION}

OPTION specifies that a part set ID is given with the single option:

### SET

If not used a part ID is assumed.

Purpose: Assign Rayleigh stiffness damping coefficient by part ID.

Card            1            2            3            4            5            6            7            8

Variable	PID/PSID	COEF						
Type	I	F						
Default	none	0.0						

### VARIABLE

### DESCRIPTION

PID/PSID

Part ID, see \*PART or part set ID, see \*SET\_PART.

COEF

Rayleigh damping coefficient. Two methods are now available:  
LT.0.0: Rayleigh damping coefficient is set based on a given frequency and applied uniformly to each element in the part ID. This approach is used in versions of LS-DYNA prior to version 960. See notes below.  
EQ.0.0: Inactive.  
GT.0.0: Rayleigh damping coefficient for stiffness weighted damping. Values between 0.01 and 0.25 are recommended. Higher values are strongly discouraged, and values less than 0.01 may have little effect. The damping coefficient is uniquely defined for each element of the part ID.

### Remarks:

The damping matrix in Rayleigh damping is defined as:

$$C = \alpha M + \beta K$$

where C, M, and K are the damping, mass, and stiffness matrices, respectively. The constants  $\alpha$  and  $\beta$  are the mass and stiffness proportional damping constants. The mass proportional

damping can be treated by system damping, see keywords: \*DAMPING\_GLOBAL and DAMPING\_PART\_MASS. Transforming C with the  $i$ th eigenvector  $\phi_i$  gives:

$$\phi_i^t C \phi_i = \phi_i^t (\alpha M + \beta K) \phi_i = \alpha + \beta \omega_i^2 = 2 \omega_i \xi_i \delta_{ij}$$

where  $\omega_i$  is the  $i$ th frequency (radians/unit time) and  $\xi_i$  is the corresponding modal damping parameter.

Generally, the stiffness proportional damping is effective for high frequencies and is orthogonal to rigid body motion. Mass proportional damping is more effective for low frequencies and will damp rigid body motion. If a large value of the stiffness based damping coefficient is used, it may be necessary to lower the time step size significantly. This must be done manually by reducing the time step scale factor on the \*CONTROL\_TIMESTEP control card. Since a good value of  $\beta$  is not easily identified, the coefficient, COEF, is defined such that a value of .10 roughly corresponds to 10% damping in the high frequency domain.

In versions prior to 960, one damping coefficient is defined that applies to all elements of the entire part. With this older approach if 10% of critical damping is sought in the  $i$ th mode then set:

$$\beta = \frac{.20}{\omega_i}$$

and input  $\beta$  as a negative number. Typically,  $\beta$  is some fraction of the time step size.

Energy dissipated by Rayleigh damping is computed if and only if the flag, RYLEN, on the control card, \*CONTROL\_ENERGY is set to 2. This energy is accumulated as element internal energy and is included in the energy balance. In the GLSTAT file this energy will be lumped in with the internal energy.

# \*DAMPING

## \*DAMPING\_RELATIVE

### \*DAMPING\_RELATIVE

Purpose: Apply damping relative to the motion of a rigid body.

Card            1            2            3            4            5            6            7            8

Variable	CDAMP	FREQ	PIDRB	PSID				
Type	F	F	F	I				
Default	0	0	0	0				

#### VARIABLE

#### DESCRIPTION

CDAMP	Fraction of critical damping.
FREQ	Frequency at which CDAMP is to apply (cycles per unit time, e.g. Hz if time unit is seconds).
PIDRB	Part ID of rigid body, see *PART. Motion relative to this rigid body will be damped.
PSID	Part set ID. The requested damping is applied only to the parts in the set.

#### Remarks:

1. This feature provides damping of vibrations for objects that are moving through space. The vibrations are damped, but not the rigid body motion. This is achieved by calculating the velocity of each node relative to that of a rigid body, and applying a damping force proportional to that velocity. The forces are reacted onto the rigid body such that overall momentum is conserved. It is intended that the rigid body is embedded within the moving object.
2. Vibrations at frequencies below FREQ are damped by more than CDAMP, while those at frequencies above FREQ are damped by less than CDAMP. It is recommended that FREQ be set to the frequency of the lowest mode of vibration.

# **\*DATABASE**

The database definitions are optional, but are necessary to obtain output files containing results information. In this section the database keywords are defined in alphabetical order:

**\*DATABASE\_OPTION**

**\*DATABASE\_RCFORC\_MOMENT**

**\*DATABASE\_ADAMS**

**\*DATABASE\_BINARY\_OPTION**

**\*DATABASE\_CPM\_SENSOR**

**\*DATABASE\_CROSS\_SECTION\_OPTION1\_{OPTION2}**

**\*DATABASE\_EXTENT\_OPTION**

**\*DATABASE\_FORMAT**

**\*DATABASE\_FSI**

**\*DATABASE\_FSI\_SENSOR**

**\*DATABASE\_HISTORY\_OPTION**

**\*DATABASE\_MASSOUT**

**\*DATABASE\_NODAL\_FORCE\_GROUP**

**\*DATABASE\_PROFILE**

**\*DATABASE\_PWP\_FLOW**

**\*DATABASE\_PWP\_OUTPUT**

**\*DATABASE\_SPRING\_FORWARD**

**\*DATABASE\_SUPERPLASTIC\_FORMING**

**\*DATABASE\_TRACER**

The ordering of the database definition cards in the input file is completely arbitrary.

**\*DATABASE\_OPTION**

Options for ASCII files include (if the file is not specified it will not be created):

<b>ABSTAT</b>	Airbag statistics.
<b>AVSFLT</b>	AVS database. See *DATABASE_EXTENT_OPTION.
<b>BNDOUT</b>	Boundary condition forces and energy
<b>CURVOUT</b>	Output from *DEFINE_CURVE_FUNCTION.
<b>DEFGEO</b>	Deformed geometry file. (Note that to output this file in Chrysler format insert the following line in your .cshrc file: “setenv LSTC_DEFGEO chrysler”) The NASBDF file (NASTRAN Bulk Data) is created whenever the DEFGEO file is requested.
<b>DCFAIL</b>	Failure function data for *MAT_SPOTWELD_DAIMLERCHRYSLER
<b>DEFORC</b>	Discrete elements.
<b>DISBOUT</b>	Discrete beam element, type 6, relative displacements, rotations, and force resultants, all in the local coordinate system, which is also output.
<b>ELOUT</b>	Element data. See *DATABASE_HISTORY_OPTION. Also, see Card 3 of the *DATABASE_EXTENT_BINARY parameters INTOUT and NODOUT. This latter option will output all integration point data or extrapolated data to the connectivity nodes in a file call ELOUTDET.
<b>GCEOUT</b>	Geometric contact entities.
<b>GLSTAT</b>	Global data. Always obtained if SSSTAT file is activated.
<b>H3OUT</b>	HybridIII rigid body dummies.
<b>JNTFORC</b>	Joint force file
<b>MATSUM</b>	Material energies. See Remarks 1 and 2 below.
<b>MOVIE</b>	MOVIE. See *DATABASE_EXTENT_OPTION.
<b>MPGS</b>	MPGS. See *DATABASE_EXTENT_OPTION.
<b>NCFORC</b>	Nodal interface forces. See *CONTACT - Card 1 (SPR and MPR)
<b>NODFOR</b>	Nodal force groups. See *DATABASE_NODAL_FORCE_GROUP.
<b>NODOUT</b>	Nodal point data. See *DATABASE_HISTORY_OPTION.
<b>RBDOUT</b>	Rigid body data. See Remark 2 below.
<b>RCFORC</b>	Resultant interface forces. Output in a local coordinate system is available, see *CONTACT, Optional Card C.
<b>RWFORC</b>	Wall forces.
<b>SBTOUT</b>	Seat belt output file
<b>SECFORC</b>	Cross section forces. See *DATABASE_CROSS_SECTION_OPTION.
<b>SLEOUT</b>	Sliding interface energy. See *CONTROL_ENERGY
<b>SPCFORC</b>	SPC reaction forces.
<b>SPHOUT</b>	SPH data. See *DATABASE_HISTORY_OPTION.
<b>SSSTAT</b>	Subsystem data. See *DATABASE_EXTENT_SSSTAT.
<b>SWFORC</b>	Nodal constraint reaction forces (spot welds and rivets).
<b>TPRINT</b>	Thermal output from a coupled structural/thermal or thermal only analysis.
<b>TRHIST</b>	Tracer particle history information. See *DATABASE_TRACER.

To include global and subsystem mass and inertial properties in the GLSTAT and SSSTAT files add the option `_MASS_PROPERTIES` as show below. If this option is active the current mass

and inertia properties are output including the principle inertias and their axes. Mass of deleted nodes and rigid bodies are not included in the calculated properties.

**GLSTAT\_MASS\_PROPERTIES** This is an option for the glstat file to include mass and inertial properties.

**SSSTAT\_MASS\_PROPERTIES** This is an option for the ssstat file to include mass and inertial properties for the subsystems.

Card            1            2            3            4            5            6            7            8

Variable	DT	BINARY	LCUR	IOOPT	OPTION1	OPTION2	OPTION3	OPTION4
Type	F	I	I	I	F/I	I	I	I
Default	0.	1 or 2	none	0.	0	0	0	0

**VARIABLE**

**DESCRIPTION**

DT                    Time interval between outputs. If DT is zero, no output is printed.

BINARY              Flag for binary output. See remarks under "Output Files and Post-Processing" in Appendix O, "LS-DYNA MPP User Guide".

EQ.1: ASCII file is written. This is the default for shared memory parallel (SMP) LS-DYNA executables.

EQ.2: Data written to a binary database "binout", which contains data that would otherwise be output to the ASCII file. The ASCII file in this case is not created. This is the default for MPP LS-DYNA executables.

EQ.3: ASCII file is written and the data is also written to the binary database (NOTE: MPP LS-DYNA executables will only produce the binary database).

LCUR                 Optional load curve ID specifying time interval between dumps.

<u>VARIABLE</u>	<u>DESCRIPTION</u>
IOOPT	<p>Flag to govern behavior of the plot frequency load curve defined by LCUR:</p> <p>EQ.1: At the time each plot is generated, the load curve value is added to the current time to determine the next plot time.(this is the default behavior)</p> <p>EQ.2: At the time each plot is generated, the next plot time T is computed so that <math>T = \text{the current time plus the load curve value at time T}</math>.</p> <p>EQ.3: A plot is generated for each abscissa point in the load curve definition. The actual value of the load curve is ignored.</p>
OPTION1	<p>OPTION1 applies to either the NODOUT or ELOUT files. For the NODOUT file OPTION1 is a real variable that defines the time interval between outputs for the high frequency file, NODOUTHF. If OPTION1 is zero, no output is printed. Nodal points that are to be output at a higher frequency are flagged using HFO in the DATABASE_HISTORY_NODE_LOCAL input. For the ELOUT file OPTION1 is a integer variable that gives the number of additional history variables written into the ELOUT file for each integration point in the solid elements. Related to the ELOUT file, see Remark 7 below.</p>
OPTION2	<p>OPTION2 applies to either the NODOUTHF or ELOUT files. For the NODOUTHF OPTION2 defines the binary file flag for the high frequency NODOUTHF file. See BINARY above. For the ELOUT file OPTION2 is a integer variable that gives the number of additional history variables written into the ELOUT file for each integration point in the shell elements. See Remark 7 below.</p>
OPTION3	<p>OPTION3 applies to the ELOUT file only. For the ELOUT file OPTION3 is a integer variable that gives the number of additional history variables written into the ELOUT file for each integration point in the thick shell elements. See Remark 7 below.</p>
OPTION4	<p>OPTION4 applies to the ELOUT file only. For the ELOUT file OPTION4 is a integer variable that gives the number of additional history variables written into the ELOUT file for each integration point in the beam elements. See Remark 7 below.</p>

The file names and corresponding unit numbers are:

	<u>I/O UNIT #</u>	<u>FILE NAME</u>
Airbag statistics	i/o unit #43	ABSTAT
ASCII database	i/o unit #44	AVSFLT
Boundary conditions	i/o unit #46	BNDOUT (nodal forces and energies)



Smug animator database	i/o unit#40	DEFGEO
Discrete elements	i/o unit#36	DEFORC
Discrete beam elements	i/o unit#215	DISBOUT
Element data	i/o unit#34	ELOUT
Contact entities	i/o unit #48	GCEOUT
Global data	i/o unit#35	GLSTAT
Joint forces	i/o unit #53	JNTFORC
Material energies	i/o unit#37	MATSUM
MOVIE file family	i/o unit #50	MOVIEnnn.xxx where nnn=001-999
MPGS file family	i/o unit #50	MPGSnnn.xxx where nnn=001-999
Nastran/BDF file	i/o unit#49	NASBDF (see comment below)
Nodal interface forces	i/o unit#38	NCFORC
Nodal force group	i/o unit #45	NODFOR
Nodal point data	i/o unit#33	NODOUT
Rigid body data	i/o unit #47	RBDOUT
Resultant interface forces	i/o unit#39	RCFORC
Rigidwall forces	i/o unit#32	RWFORC
Seat belts	i/o unit #52	SBTOUT
Cross-section forces	i/o unit#31	SECFORC
Interface energies	i/o unit #51	SLEOUT
SPC reaction forces	i/o unit#41	SPCFORC
SPH element data	i/o unit#68	SPHOUT
Subsystems statistics	i/o unit#58	SSSTAT
Nodal constraint resultants	i/o unit #42	SWFORC (spot welds/rivets)
Thermal output	i/o unit #73	TPRINT
Tracer particles	i/o unit #70	TRHIST

**Output Components for ASCII Files**

<b>ABSTAT</b>	<b>BNDOUT</b>	<b>DCFAIL</b>	<b>DEFORC</b>
<b>volume</b>	<b>x, y, z force</b>	<b>failure function</b>	<b>x, y, z force</b>
<b>pressure</b>		<b>normal term</b>	
<b>internal energy</b>		<b>bending term</b>	
<b>input mass flow rate</b>		<b>shear term</b>	
<b>output mass flow rate</b>		<b>weld area</b>	
<b>mass</b>		<b>effective strain rate</b>	
<b>temperature</b>			
<b>density</b>			

<b>ELOUT</b>			
<b>Beam</b>	<b>Shell and Tshell Stress</b>	<b>Solid Stress</b>	<b>Strain (see remark)</b>
<b>axial force resultant</b>	<b>xx, yy, zz stress</b>	<b>xx, yy, zz stress</b>	<b>xx, yy, zz strain</b>
<b>s shear resultant</b>	<b>xy, yz, zx stress</b>	<b>xy, yz, zx stress</b>	<b>xy, yz, zx strain</b>
<b>t shear resultant</b>	<b>plastic strain</b>	<b>effective stress</b>	
<b>s moment resultant</b>		<b>yield function</b>	
<b>t moment resultant</b>			
<b>torsional resultant</b>			

Strains written for solids and for lower and upper integration points of shells and tshells if STRFLG=1 in \*DATABASE\_EXTENT\_BINARY.

<b>GCEOUT</b>	
<b>x, y, z force</b>	<b>x, y, z moment</b>

<b>GLSTAT</b>	
<b>time step</b>	<b>total energy</b>
<b>kinetic energy</b>	<b>external work</b>
<b>internal energy</b>	<b>total energy / initial energy</b>
<b>spring &amp; damper energy</b>	<b>energy ratio w/o eroded energy</b>
<b>hourglass energy</b>	<b>element id controlling time step</b>
<b>system damping energy</b>	<b>global x, y, z velocity</b>
<b>sliding interface energy</b>	<b>time per zone cycle</b>
<b>eroded kinetic energy</b>	<b>joint internal energy</b>
<b>eroded internal energy</b>	<b>stonewall energy</b>
<b>eroded hourglass energy</b>	<b>rigid body stopper energy</b>

<b>JNFORC</b>	
<b>x, y, z force</b>	<b>x, y, z moment</b>

<b>MATSUM</b>	
<b>kinetic energy</b>	<b>x, y, z rigid body velocity</b>
<b>internal energy</b>	<b>eroded internal energy</b>
<b>hourglass energy</b>	<b>eroded kinetic energy</b>
<b>x, y, z momentum</b>	<b>added mass</b>

<b>NCFORC</b>	<b>NODOUT</b>	<b>NODFOR</b>
x force	x, y, z displacement	x, y, z force
y force	x, y, z velocity	
z force	x, y, z acceleration	
	x, y, z rotation	
	x, y, z rotational velocity	
	x, y, z rotational acceleration	

<b>RBDOUT</b>	<b>RCFORC</b>	<b>RWFORC</b>
x, y, z displacement	x, y, z force	normal
x, y, z velocity	Mass of nodes in contact	x, y, z force
x, y, z acceleration		

<b>SECFORC</b>	<b>SLEOUT</b>	<b>SPCFORC</b>	<b>SWFORC</b>
x, y, z force	slave energy	x, y, z force	axial force
x, y, z moment	master energy	x, y, z moment	shear force
x, y, z center	frictional energy		
area			
resultant force			

**Remarks:**

- The kinetic energy quantities in the MATSUM and GLSTAT files may differ slightly in values for several reasons. First, the energy associated with added mass (from mass-scaling) is included in the GLSTAT calculation, but is not included in MATSUM. Secondly, the energies are computed element by element in MATSUM for the deformable materials and, consequently, nodes which are merged with rigid bodies will also have their kinetic energy included in the rigid body total. Furthermore, kinetic energy is computed from nodal velocities in GLSTAT and from element midpoint velocities in MATSUM.
- The PRINT option in the part definition allows some control over the extent of the data that is written into the MATSUM and RBDOUT files. If the print option is used the variable PRBF can be defined such that the following numbers take on the meanings:
  - EQ.0: default is taken from the keyword \*CONTROL\_OUTPUT,
  - EQ.1: write data into RBDOUT file only,
  - EQ.2: write data into MATSUM file only,
  - EQ.3: do not write data into RBDOUT and MATSUM.

Also see CONTROL\_OUTPUT and PART\_PRINT.

3. This keyword is also used in the restart phase, see \*RESTART. Thus, the output interval can be changed when restarting.
4. All information in the files except in AVSFLT, MOVIE, AND MPGS can also be plotted using the post-processor LS-PREPOST. Arbitrary cross plotting of results between ASCII files is easily handled.
5. Resultant contact forces reported in RCFORC are averaged over the preceding output interval.
6. “Spring and damper energy” reported in GLSTAT is a subset of “Internal energy”. The “Spring and damper energy” includes internal energy of discrete elements, seatbelt elements, and that associated with joint stiffness (see \*CONSTRAINED\_JOINT\_STIFFNESS\_...).
7. OPTION1, OPTION2, OPTION3, and OPTION4 give the number of additional history variables output for the integrated solids, shells, thick shells, and beams, respectively. Within this special option, each integration point is printed with its corresponding history data. No integration points are averaged. This is different than the default output where the stress data within a shell ply of a fully integrated shell, for example, are averaged and then written as output. The primary purpose of this database extension is to allow the actual integration point stress data and history variable data to be checked. There are no transformations applied to either the output stresses or history data.

**\*DATABASE\_RCFORC\_MOMENT**

Purpose: Define contact ID and nodes for moment calculations. Moments are written to rforc according to output interval given in \*DATABASE\_RCFORC. If \*DATABASE\_RCFORC\_MOMENT is not used, the moments reported to rforc are about the origin (0,0,0).

Card            1            2            3            4            5            6            7            8

Variable	CID	NODES	NODEM					
Type	I	I	I					

<u>VARIABLE</u>	<u>DESCRIPTION</u>
CID	Contact ID
NODES	Node about which moments are calculated due to contact forces on slave surface.
NODEM	Node about which moments are calculated due to contact forces on master surface.

**\*DATABASE\_ADAMS**

Purpose: Request output of an MDI Modal Neutral File for later use in the ADAMS software.

Card            1            2            3            4            5            6            7            8

Variable	IFLAG	M_UNITS	L_UNITS	T_UNITS				
Type	I	F	F	F				
Default	0	none	none	none				

**VARIABLE****DESCRIPTION**

IFLAG            Flag controlling write of modal neutral file after eigenvalue analysis  
                   EQ.0: do not write (default),  
                   EQ.1: write to file "d3mnf"

M\_UNITS        Mass units of measure used in this model.  
                   EQ.-1: kilogram  
                   EQ.-2: gram  
                   EQ.-3: megagram (metric ton)  
                   EQ.-4: lbf\*sec\*\*2/in (psi-compatible)  
                   EQ.-5: slug  
                   EQ.-6: pound-mass

L\_UNITS        Length units of measure used in this model.  
                   EQ.-1: meter  
                   EQ.-2: centimeter  
                   EQ.-3: millimeter  
                   EQ.-4: inch  
                   EQ.-5: foot

T\_UNITS        Time units of measure used in this model.  
                   EQ.-1: second  
                   EQ.-2: millisecond  
                   EQ.-3: minute  
                   EQ.-4: hour

**Remarks:**

1. This option is not available for every platform. Check LS-DYNA Banner upon execution of the program to see if this feature is enabled.
2. Models must be created using a combination of the above units.

**\*DATABASE\_BINARY\_OPTION**

Options for binary output files with the default names given include:

<b>BLSTFOR</b>	Blast pressure database. See also *LOAD_BLAST_ENHANCED.
<b>D3DRLF</b>	Dynamic relaxation database.
<b>D3DUMP</b>	Binary output restart files. Define output frequency in cycles.
<b>D3PART</b>	Dt for partial output states See also *DATABASE_EXTENT_BINARY.
<b>D3PLOT</b>	Dt for complete output states. See also *DATABASE_EXTENT_BINARY.
<b>D3PROP</b>	Output property data.
<b>D3THDT</b>	Dt for time history data of element subsets. See *DATABASE_HISTORY.
<b>FSIFOR</b>	ALE interface force database (please see Remark 1).
<b>RUNRSF</b>	Binary output restart file. Define output frequency in cycles.
<b>INTFOR</b>	Dt for output of contact interface data (file name must be given on the execution line using "S="). Also see *CONTACT variables mpr and spr.
<b>XTFILE</b>	Flag to specify output of extra time history data to XTFILE at same time as D3THDT file. The following card is left blank for this option.
<b>D3CRACK</b>	Dt for output of an ASCII "aea_crack" data file for the Winfrith concrete model (*MAT_084/085). This dt does not control the output of the altogether different binary crack database. The binary crack database is written when "q=" appears on the execution line and its output interval is taken from *DATABASE_BINARY_D3PLOT, It's used by LS-PrePost together with the D3PLOT database to display cracks in the deformed Winfrith concrete materials.

The D3DUMP and the RUNRSF options create complete databases which are necessary for restarts, see \*RESTART. When RUNRSF is specified, the same file is overwritten after each interval, an option allows a series of files to be overwritten in a cyclic order. When D3DUMP is specified, a new restart file is created after each interval. When D3DUMP is specified, a new restart file is created after each interval, thus a "family" of files is created numbered sequentially D3DUMP01, D3DUMP02, etc. The default file names are RUNRSF and D3DUMP unless other names are specified on the execution line, see the INTRODUCTION, EXECUTION SYNTAX. Since all data held in memory is written into the restart files, these files can be quite large and care should be taken with the D3DUMP files not to create too many. If \*DATABASE\_BINARY\_D3PLOT is not specified in the keyword deck then a complete output state will be written ever time step.

The D3PLOT, D3PART, D3DRLF, and the INTFOR files contain plotting information to plot data over the three dimensional geometry of the model. These databases can be plotted with LS-PREPOST. The D3THDT file contains time history data for element subsets as well as global information, see \*DATABASE\_HISTORY. This data can be plotted with LS-PREPOST. The default names for the D3PLOT, D3PART, D3DRLF, and the D3THDT files are D3PLOT, D3PART, D3DRLF, and D3THDT. For INTFOR a unique name must be specified on the execution line with S=iff, (iff=file name), for FSIFOR a unique name must be specified on the execution line with h=iff, (iff=file name), see the INTRODUCTION, EXECUTION SYNTAX. The file structure is such that each file contains the full geometry at the beginning, followed by the analysis generated output data at the specified time intervals. For the contents of the



D3PLOT, D3PART and D3THDT files see also the \*DATABASE\_EXTENT\_BINARY definition. It is possible to severely restrict the information that is dumped and consequently reduce the size of the databases. The contents of the D3THDT file are also specified with the \*DATABASE\_HISTORY definition. It should also be noted in particular that the databases can be considerably reduced for models with rigid bodies containing many elements.

Card            1            2            3            4            5            6            7            8

Variable	DT/CYCL	LCDT/NR	BEAM	NPLTC	PSETID			
Type	F	I	I	I	I			
Default	-	-	-	-	-			
Remarks					2			

**Optional Card that only applies to the D3PLOT database**

Card            1            2            3            4            5            6            7            8

Variable	IOOPT							
Type	I							
Default	0							

**Use only for D3PROP option (No other cards are necessary)**

Card            1            2            3            4            5            6            7            8

Variable	IFILE	IMATL	IWALL					
Type	I	I	I					
Default	1	0	0					

---

<u>VARIABLE</u>	<u>DESCRIPTION</u>
DT	Time interval between outputs.
CYCL	Output interval in time steps (a time step is a cycle). For the D3DRFL file a positive number 'n' will cause plot dumps to be written at every n'th convergence check interval specified on the *CONTROL_DYNAMIC_RELAXATION card.
NR	Number of Running Restart Files, RUNRSF, written in a cyclical fashion. The default number is one, i.e. the same file is overwritten each time.
LCDT	Optional load curve ID specifying time interval between dumps. This option is only available for the D3PLOT, D3PART, D3THDT and INTFOR files.
BEAM	Option flag for *DATABASE_BINARY_D3PLOT or D3PART. EQ.0: Discrete spring and damper elements are added to the D3PLOT or D3PART database where they are display as beam elements. The element global X, global Y, global Z and resultant forces are written to the database. EQ.1: No discrete spring and damper elements are added to the D3PLOT or D3PART database. This option is useful when translating old LS-DYNA input decks to KEYWORD input. In older input decks there is no requirement that beam and spring elements have unique ID's, and beam elements may be created for the spring and dampers with identical ID's to existing beam elements causing a fatal error. Contact interfaces which are based on part IDs of seatbelt elements will not be properly generated if this option is used. EQ.2: Discrete spring and damper elements are added to the D3PLOT or D3PART database where they are displayed as beam elements (similar to option 0). In this option the element resultant force is written to its first database position allowing beam axial forces and spring resultant forces to be plotted at the same time. This can be useful during some post-processing applications.
NPLTC	DT=ENDTIME/NPLTC applies to D3PLOT and D3PART only. This overrides the DT specified in the first field.
PSETID	SET_PART ID for D3PART and D3PLOT only.

<b>VARIABLE</b>	<b>DESCRIPTION</b>
IOOPT	This option applies to the D3PLOT file only. Flag to govern behavior of the plot frequency load curve defined by LCDT: EQ.1: At the time each plot is generated, the load curve value is added to the current time to determine the next plot time (this is the default behavior). EQ.2: At the time each plot is generated, the next plot time T is computed so that $T = \text{the current time plus the load curve value at time T}$ . EQ.3: A plot is generated for each abscissa point in the load curve definition. The actual value of the load curve is ignored.
IFILE	Specify file for D3PROP output. (This can also be defined on the command line by adding $d3prop = 1$ or $d3prop = 2$ which also sets $IMATL = IWALL = 1$ ) EQ.1: Output data at the end of the first d3plot file. EQ.2: Output data to the file d3prop.
IMATL	Output *EOS, *HOURLASS, *MAT, *PART and *SECTION data. EQ.0: No EQ.1: Yes
IWALL	Output *RIGIDWALL data. EQ.0: No EQ.1: Yes

**Remarks:**

1. \*DATABASE\_BINARY\_FSIFOR only applies to models having penalty-based coupling between Lagrangian and ALE materials (CTYPE=4 or 5 in the coupling card, \*CONSTRAINED\_LAGRANGE\_IN\_SOLID). When \*DATABASE\_FSI is defined, a few pieces of coupling information of some Lagrangian surface entities interacting with the ALE materials may be output as history parameters into a file called "dbfsi". Coupling pressure is one of the output variables. However, this coupling pressure is averaged over the whole surface entity being monitored. To obtain coupling pressure contour plot as a function of time over the coupled surface, a user can define the \*DATABASE\_BINARY\_FSIFOR keyword. To use it, three things must be done:
  - 1) The INTFORC parameter (\*CONSTRAINED\_LAGRANGE\_IN\_SOLID, 4<sup>th</sup> row, 3<sup>rd</sup> column) must be turned ON (INTFORC=1).
  - 2) A \*DATABASE\_BINARY\_FSIFOR card is defined controlling the output interval. The time interval between output is defined by the parameter DT in this card.
  - 3) This interface force file is activated by executing ls970 as follow:

ls970 i=inputfilename.k ... h=interfaceforcefilename

LSDYNA will then writes out the segment coupling pressure and forces to a binary interface force file for contour plotting over the whole simulation interval.

To plot the binary data in this file, type: lsprepost interfaceforcefilename.

For example, when all 3 of the above actions are taken, and let's assume we define the interfaceforcefilename = fsifor → a series of "fsifor##" binary files are output for contour plotting. To plot this, type "lsprepost fsifor" (without the double quotes).

- 2) For the D3PLOT database, parts in PSETID will excluded.. For the D3PART database, only parts in PSETID will be included.

**\*DATABASE\_CPM\_SENSOR**

Purpose: This card activates an ASCII file “cpm\_sensor”. Its input defines sensors’ locations based on the positions of some Lagrangian segments. The output gives the history of the velocity, temperature, density and pressure averaged on the number of particles contained in the sensors. This card is activated only when the \*AIRBAG\_PARTICLE card is used.

Card 1            1            2            3            4            5            6            7            8

Variable	DT	BINARY						
Type	F	I						

**Card 2,..., Define one segment set per line. Input stops when the next “\*” Keyword is found.**

Card 2,3,...      1            2            3            4            5            6            7            8

Variable	SEGID	OFFSET	RADIUS	LENGTH				
Type	I	F	F	F				

<u>VARIABLE</u>	<u>DESCRIPTION</u>
DT	Output interval
BINARY	Flag for the binary file EQ.1: ASCII file is written, EQ.2: Data written to the binary file “binout”, EQ.3: ASCII file is written and the data written to the binary file “binout”
SEGID	Segment set ID
OFFSET	Offset distance between the center of the sphere sensor and the segment center. If it is positive, Or, the distance between the base of the cylinder and the segment center while LENGTH is not zero. it is on the side pointed to by the segment normal vector. See remarks1 and 3.
RADIUS	Radius of the sensor. See remarks 2 and 3.
LENGTH	Length of the sensor. (for cylindrical sensor)

**Remarks:**

1. Each segment has a sensor. The distance between the segment center and the sensor center is defined by OFFSET (2<sup>nd</sup> parameter on the 2<sup>nd</sup> line) in the normal direction defined by the segment. This distance is constant: the sensor moves along with the segment.
2. The sensor is a sphere with a radius given by RADIUS (3<sup>rd</sup> parameter on the 2<sup>nd</sup> line).
3. OFFSET should be larger than RADIUS to prevent the segment from cutting the sphere. For cylindrical sensor, OFFSET is the distance from segment to the base of the cylinder.
4. The output parameters in the "cpm\_sensor" file are:
  - velx = x-velocity
  - vely = y-velocity
  - velz = z-velocity
  - velr = velocity
  - temp = temperature
  - dens =density
  - pres =pressure

These values are averaged on the number of particles in the sensor. RADIUS should be large enough to contain a reasonable number of particles for the averages.

```

$...|...1....|...2....|...3....|...4....|...5....|...6....|...7....|.
$ INPUT:
$...|...1....|...2....|...3....|...4....|...5....|...6....|...7....|.
*DATABASE_CPM_SENSOR
  0.01
$  SEGSID   OFFSET   RADIUS   LENGTH
    123      5.0      5.0
    124     -0.2      0.1
    125      0.7      0.6      1.0
$...|...1....|...2....|...3....|...4....|...5....|...6....|...7....|.
$ The segment set id: 123 has 1 segment.
$ The segment set id: 123 has 1 segment.
$ The segment set id: 123 has 11 segments.
$ Each segment has an ID defined in D3HSP
$ The D3HSP file looks like the following:
$...|...1....|...2....|...3....|...4....|...5....|...6....|...7....|.
Segments for sensor      1
  Sensor id      n1      n2      n3      n4
    1      3842      3843      3848      3847
Segments for sensor      2
  Sensor id      n1      n2      n3      n4
    2      3947      3948      3953      3952

Segments for sensor      3
  Sensor id      n1      n2      n3      n4
    3      3867      3868      2146      2145
    4      3862      3863      3868      3867
    5      3857      3858      3863      3862

```

**\*DATABASE\_CPM\_SENSOR**

**\*DATABASE**

---

6	3852	3853	3858	3857
7	3847	3848	3853	3852
8	3837	3838	3843	3842
9	3842	3843	3848	3847
10	3832	3833	3838	3837
11	3827	3828	3833	3832
12	3822	3823	3828	3827
13	1125	1126	3823	3822

\$...|...1...|...2...|...3...|...4...|...5...|...6...|...7...|..





**Card (1 of 2) for the PLANE option**

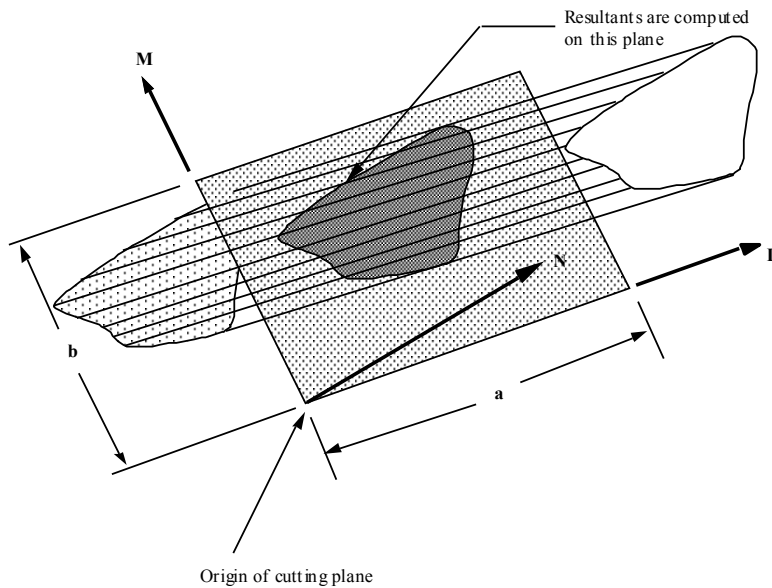
Card            1            2            3            4            5            6            7            8

Variable	PSID	XCT	YCT	ZCT	XCH	YCH	ZCH	RADIUS
Type	I	F	F	F	F	F	F	F
Default	0	0.	0.	0.	0.	0.	0.	0.

**Card (2 of 2) for the PLANE option**

Card            1            2            3            4            5            6            7            8

Variable	XHEV	YHEV	ZHEV	LENL	LENM	ID	ITYPE	
Type	F	F	F	F	F	I	I	
Default	0.	0.	0.	infinity	infinity	global	0	



**Figure 12.1.** Definition of cutting plane for automatic definition of interface for cross-sectional forces. The automatic definition does not check for springs and dampers in the section. For best results the cutting plane should cleanly pass through the middle

of the elements, distributing them equally on either side. Elements that intersect the edges of the cutting plane are deleted from the cross-section.

The set option requires that the equivalent of the automatically generated input via the cutting plane be identified manually and defined in sets. All nodes in the cross-section and their related elements that contribute to the cross-sectional force resultants should be defined.

**Card (1 of 1) for the SET option**

Card            1            2            3            4            5            6            7            8

Variable	NSID	HSID	BSID	SSID	TSID	DSID	ID	ITYPE
Type	I	I	I	I	I	I	I	I
Default	required	0	0	0	0	0	global	0

**VARIABLE****DESCRIPTION**

CSID	Optional ID for cross section. If not specified cross section ID is taken to be the cross section order in the input deck.
PSID	Part set ID. If zero all parts are included.
XCT	x-coordinate of tail of any outward drawn normal vector, <b>N</b> , originating on wall (tail) and terminating in space (head), see Figure 12.1.
YCT	y-coordinate of tail of normal vector, <b>N</b> .
ZCT	z-coordinate of tail of normal vector, <b>N</b> .
XCH	x-coordinate of head of normal vector, <b>N</b> .
YCH	y-coordinate of head of normal vector, <b>N</b> .
ZCH	z-coordinate of head of normal vector, <b>N</b> .
RADIUS	Optional radius. If RADIUS > 0., a circular cut plane centered at (XCT, YCT, ZCT) of radius=RADIUS, with the normal vector originating at (XCT, YCT, ZCT) and pointing towards (XCH, YCH, ZCH) will be created. In this case the variables XHEV, YHEV, ZHEV, LENL, and LENM, which are defined on the 2 <sup>nd</sup> card will be ignored.
XHEV	x-coordinate of head of edge vector, <b>L</b> .

---

<b>VARIABLE</b>	<b>DESCRIPTION</b>
YHEV	y-coordinate of head of edge vector, <b>L</b> .
ZHEV	z-coordinate of head of edge vector, <b>L</b> .
LENL	Length of edge a, in <b>L</b> direction.
LENM	Length of edge b, in <b>M</b> direction.
NSID	Nodal set ID, see *SET_NODE_OPTION.
HSID	Solid element set ID, see *SET_SOLID.
BSID	Beam element set ID, see *SET_BEAM.
SSID	Shell element set ID, see *SET_SHELL_OPTION.
TSID	Thick shell element set ID, see *SET_TSHELL.
DSID	Discrete element set ID, see *SET_DISCRETE.
ID	Rigid body (see *MAT_RIGID, type 20), accelerometer ID (see *ELEMENT_SEATBELT_ACCELEROMETER) or coordinate ID, see *DEFINE_COORDINATE_NODES. The force resultants are output in the <u>updated</u> local system of the rigid body, accelerometer, or coordinate system.
ITYPE	Flag for local system type: EQ.0: rigid body, EQ.1: accelerometer, EQ.2: coordinate ID.

**\*DATABASE\_EXTENT\_OPTION**

Available options include:

- AVS**
- BINARY**
- D3PART**
- INTFOR**
- MOVIE**
- MPGS**
- SSSTAT**

Purpose: Control to some extent the content of specific output databases. The BINARY option of \*DATABASE\_EXTENT applies to the data written to the D3PLOT, D3PART, and D3THDT files. See also \*DATABASE\_BINARY\_OPTION.

**AVS, MPGS, and MOVIE** options:

Define as many cards as necessary. The created MPGS and MOVIE databases consist of a geometry file and one file for each output database.

Card	1	2	3	4	5	6	7	8
------	---	---	---	---	---	---	---	---

Variable	VTYPE	COMP						
Type	I	I						

<u><b>VARIABLE</b></u>	<u><b>DESCRIPTION</b></u>
------------------------	---------------------------

VTYPE	Variable type: EQ.0: node, EQ.1: brick, EQ.2: beam, EQ.3: shell, EQ.4: thick shell.
-------	--

<u>VARIABLE</u>	<u>DESCRIPTION</u>
COMP	Component ID. For the corresponding VTYPE, integer components from the following tables can be chosen: VTYPE.EQ.0: Table 12.1, VTYPE.EQ.1: Table 12.2, VTYPE.EQ.2: not supported, VTYPE.EQ.3: Table 12.3, VTYPE.EQ.4: not supported.

**Remarks:**

The AVS database consists of a title card, then a control card defining the number of nodes, brick-like elements, beam elements, shell elements, and the number of nodal vectors, NV, written for each output interval. The next NV lines consist of character strings that describe the nodal vectors. Nodal coordinates and element connectivity follow. For each state the solution time is written, followed by the data requested below. The last word in the file is the number of states. We recommend creating this file and examining its contents, since the organization is relatively transparent. The MOVIE and MPGS database are widely used and will be familiar with users who are currently using these databases.

**Table 12.1.** Nodal Quantities

Component ID	Quantity
1	x, y, z-displacements
2	x, y, z-velocities
3	x, y, z-accelerations

**Table 12.2.** Brick Element Quantities

Component ID	Quantity
1	x-stress
2	y-stress
3	z-stress
4	xy-stress
5	yz-stress
6	zx-stress
7	effective plastic strain

**Table 12.3.** Shell and Thick Shell Element Quantities

Component ID	Quantity
1	midsurface x-stress
2	midsurface y-stress
3	midsurface z-stress
4	midsurface xy-stress
5	midsurface yz-stress
6	midsurface xz-stress
7	midsurface effective plastic strain
8	inner surface x-stress
9	inner surface y-stress
10	inner surface z-stress
11	inner surface xy-stress
12	inner surface yz-stress
13	inner surface zx-stress
14	inner surface effective plastic strain
15	outer surface x-stress
16	outer surface y-stress
17	outer surface z-stress
18	outer surface xy-stress
19	outer surface yz-stress
20	outer surface zx-stress
21	outer surface effective plastic strain
22	bending moment-mxx (4-node shell)
23	bending moment-myy (4-node shell)
24	bending moment-mxy (4-node shell)
25	shear resultant-qxx (4-node shell)
26	shear resultant-qyy (4-node shell)
27	normal resultant-nxx (4-node shell)
28	normal resultant-nyy (4-node shell)
29	normal resultant-nzz (4-node shell)
30	thickness (4-node shell)
31	element dependent variable
32	element dependent variable
33	inner surface x-strain
34	inner surface y-strain
35	inner surface z-strain
36	inner surface xy-strain
37	inner surface yz-strain
38	inner surface zx-strain
39	outer surface x-strain
40	outer surface y-strain
41	outer surface z-strain
42	outer surface xy-strain
43	outer surface yz-strain

**Table 12.3.** Shell and Thick Shell Element Quantities (cont.).

Component ID	Quantity
44	outer surface zx-strain
45	internal energy
46	midsurface effective stress
47	inner surface effective stress
48	outer surface effective stress
49	midsurface max. principal strain
50	through thickness strain
51	midsurface min. principal strain
52	lower surface effective strain
53	lower surface max. principal strain
54	through thickness strain
55	lower surface min. principal strain
56	lower surface effective strain
57	upper surface max. principal strain
58	through thickness strain
59	upper surface min. principal strain
60	upper surface effective strain

**Table 12.4.** Beam Element Quantities

Component ID	Quantity
1	x-force resultant
2	y-force resultant
3	z-force resultant
4	x-moment resultant
5	y-moment resultant
6	z-moment resultant

**BINARY** option:**For the BINARY option the following cards apply (Card 3 is optional):**

Card 1            1            2            3            4            5            6            7            8

Variable	NEIPH	NEIPS	MAXINT	STRFLG	SIGFLG	EPSFLG	RLTFLG	ENGFLG
Type	I	I	I	I	I	I	I	I
Default	0	0	3	0	1	1	1	1
Remarks			1					

Card 2

Variable	CMPFLG	IEVERP	BEAMIP	DCOMP	SHGE	STSSZ	N3THDT	IALEMAT
Type	I	I	I	I	I	I	I	I
Default	0	0	0	0	0	0	2	1
Remarks			2					

Card 3            1            2            3            4            5            6            7            8

Variable	NINTSLD	PKP_SEN	SCLP	HYDRO	MSSCL	THERM	INTOUT	NODOUT
Type	I	I	F	I	I	I	A	A
Default	1	0	1.0	0	0	0	none	none
Remarks							4-10	4-10



Card 4            1            2            3            4            5            6            7            8

Variable	DTDT							
Type	I							
Default	1							
Remarks								

**VARIABLE**

**DESCRIPTION**

NEIPH            Number of additional integration point history variables written to the binary database for solid elements. The integration point data is written in the same order that it is stored in memory-each material model has its own history variables that are stored. For user defined materials it is important to store the history data that is needed for plotting before the data which is not of interest.

NEIPS            Number of additional integration point history variables written to the binary database for both shell and thick shell elements for each integration point, see NEIPH above.

MAXINT            Number of shell integration points written to the binary database, see also \*INTEGRATION\_SHELL. If the default value of 3 is used then results are output for the outermost (top) and innermost (bottom) integration points together with results for the neutral axis. If MAXINT is set to 3 and the element has 1 integration point then all three results will be the same. If a value other than 3 is used then results for the first MAXINT integration points in the element will be output. Note: If the element has an even number of integration points and MAXINT is not set to 3 then you will not get mid-surface results. See Remarks below. If MAXINT is set to a negative number, MAXINT integration points are output for each in plane integration point location and no averaging is used. This can greatly increase the size of the binary databases D3PLOT, D3THDT, and D3PART.

STRFLG            Set to 1 to dump strain tensors for solid, shell and thick shell elements for plotting by LS-PREPOST and ASCII file ELOUT. For shell and thick shell elements two tensors are written, one at the innermost and one at the outermost integration point. For solid elements a single strain tensor is written.

---

<b>VARIABLE</b>	<b>DESCRIPTION</b>
SIGFLG	Flag for including stress tensor in the shell LS-DYNA database: EQ.1: include (default), EQ.2: exclude.
EPSFLG	Flag for including the effective plastic strains in the shell LS-DYNA database: EQ.1: include (default), EQ.2: exclude.
RLTFLG	Flag for including stress resultants in the shell LS-DYNA database: EQ.1: include (default), EQ.2: exclude.
ENGFLG	Flag for including shell internal energy density and thickness in the LS-DYNA database: EQ.1: include (default), EQ.2: exclude.
CMPFLG	Orthotropic and anisotropic material stress and strain output in local material coordinate system for solids, shells and thick shells. Orthotropic and anisotropic materials input parameters, e.g., AOPT, for defining the material coordinate system. EQ.0: global, EQ.1: local.
IEVERP	Every plot state for “d3plot” database is written to a separate file. This option will limit the database to 1000 states: EQ.0: more than one state can be on each plotfile, EQ.1: one state only on each plotfile.
BEAMIP	Number of beam integration points for output. This option does not apply to beams that use a resultant formulation.
DCOMP	Data compression to eliminate rigid body data: EQ.1: off (default), no rigid body data compression, EQ.2: on, rigid body data compression active, EQ.3: off, no rigid body data compression, but nodal velocities and accelerations are eliminated from the database. EQ.4: on, rigid body data compression active and nodal velocities and accelerations are eliminated from the database.
SHGE	Output shell hourglass energy density: EQ.1: off (default), no hourglass energy written, EQ.2: on.

---

<b>VARIABLE</b>	<b>DESCRIPTION</b>
STSSZ	Output shell element time step, mass, or added mass: EQ.1: off (default), EQ.2: output time step size, EQ.3: output mass, added mass, or time step size. See remark 3 below.
N3THDT	Material energy write option for D3THDT database EQ.1: off, energy is NOT written to D3THDT database, EQ.2: on (default), energy is written to D3THDT database.
IALEMAT	Output solid part ID list containing ale materials. EQ.1: on (default)
NINTSLD	Number of solid element integration points written to the LS-DYNA database. The default value is 1. For solids with multiple integration points NINTSLD may be set to 8. Currently, no other values for NINTSLD are allowed. For solids with multiple integration points, an average value is output if NINTSLD is set to 1.
PKP_SEN	Flag to output the peak pressure and surface energy computed by each contact interface into the interface force database. To obtain the surface energy, FRCENG, must be sent to 1 on the control contact card. When PKP_SEN=1, it is possible to identify the energies generated on the upper and lower shell surfaces, which is important in metal forming applications. This data is mapped after each H-adaptive remeshing. EQ.0: No data is written EQ.1: Output the peak pressures and surface energy by contact interface
SCLP	A scaling parameter used in the computation of the peak pressure. This parameter is generally set to unity (the default), but it must be greater than 0.
HYDRO	Either 3 or 5 additional history variables useful to shock physics are output as the last history variables. For HYDRO=1, the internal energy per reference volume, the reference volume, and the value of the bulk viscosity are added to the database, and for HYDRO=2, the volume strain and current density are also added.

---

<b>VARIABLE</b>	<b>DESCRIPTION</b>
MSSCL	<p>Output nodal information related to mass scaling into the D3PLOT database. This option can be activated if and only if DT2MS &lt; 0.0, see control card *CONTROL_TIMESTEP. This option is available starting with the second release of Version 971.</p> <p>EQ.0: No data is written EQ.1: Output incremental nodal mass EQ.2: Output percentage increase in nodal mass</p>
THERM	<p>Output of thermal data to d3plot. The use of this option (THERM&gt;0) may make the database incompatible with other 3<sup>rd</sup> party software.</p> <p>EQ.0: (default) output temperature EQ.1: output temperature EQ.2: output temperature and flux EQ.3: output temperature, flux, and shell bottom and top surface temperature</p>
INTOUT	<p>Output stress/strain at all integration points for detailed element output in the file ELOUTDET. DT and BINARY of *DATABASE_ELOUT apply to ELOUTDET. See remarks 4-10 below.</p> <p>EQ.STRESS: when stress output is required EQ.STRAIN when strain output is required EQ.ALL when both stress and strain output are required</p>
NODOUT	<p>Output extrapolated stress/strain at connectivity nodes for detailed element output in the file ELOUTDET. DT and BINARY of *DATABASE_ELOUT apply to ELOUTDET.</p> <p>EQ.STRESS when stress output is required EQ.STRAIN when strain output is required EQ.ALL when both stress and strain output are required EQ.STRESS_GL when nodal averaged stress output along the global coordinate system is required EQ.STRAIN_GL when nodal averaged strain output along the global coordinate system is required EQ.ALL_GL for global nodal averaged stress and strain output</p>
DTDT	<p>Output of node point <math>\Delta</math>temperature/<math>\Delta</math>time data to d3plot</p> <p>EQ.0: (default) no output EQ.1: output <math>\Delta T/\Delta t</math></p>

**D3PART** option:

**For the D3PART option the following cards apply (Card 3 is optional) The parameters given here will supercede the corresponding parameter in \*DATABASE\_EXTENT\_BINARY when writing D3PART data.**

Card 1            1            2            3            4            5            6            7            8

Variable	NEIPH	NEIPS	MAXINT	STRFLG	SIGFLG	EPSFLG	RLTFLG	ENGFLG
Type	I	I	I	I	I	I	I	I
Default	0	0	3	0	1	1	1	1
Remarks			1					

Card 2            1            2            3            4            5            6            7            8

Variable		IEVERP			SHGE	STSSZ		
Type		I			I	I		
Default		0			0	0		
Remarks								

Card 3            1            2            3            4            5            6            7            8

Variable	NINTSLD							
Type	I							
Default	1							
Remarks								

**VARIABLE****DESCRIPTION**

NEIPH	Number of additional integration point history variables written to the binary database for solid elements. The integration point data is written in the same order that it is stored in memory-each material model has its own history variables that are stored. For user defined materials it is important to store the history data that is needed for plotting before the data which is not of interest.
NEIPS	Number of additional integration point history variables written to the binary database for both shell and thick shell elements for each integration point, see NEIPH above.
MAXINT	Number of shell integration points written to the binary database, see also *INTEGRATION_SHELL. If the default value of 3 is used then results are output for the outermost (top) and innermost (bottom) integration points together with results for the neutral axis. If MAXINT is set to 3 and the element has 1 integration point then all three results will be the same. If a value other than 3 is used then results for the first MAXINT integration points in the element will be output. Note: If the element has an even number of integration points and MAXINT is not set to 3 then you will not get mid-surface results. See Remarks below. If MAXINT is set to a negative number, MAXINT integration points are output for each in plane integration point location and no averaging is used. This can greatly increase the size of the binary databases D3PLOT, D3THDT, and D3PART.
STRFLG	Set to 1 to dump strain tensors for solid, shell and thick shell elements for plotting by LS-PREPOST and ASCII file ELOUT. For shell and thick shell elements two tensors are written, one at the innermost and one at the outermost integration point. For solid elements a single strain tensor is written.

---

<b>VARIABLE</b>	<b>DESCRIPTION</b>
SIGFLG	Flag for including stress tensor in the shell LS-DYNA database: EQ.1: include (default), EQ.2: exclude.
EPSFLG	Flag for including the effective plastic strains in the shell LS-DYNA database: EQ.1: include (default), EQ.2: exclude.
RLTFLG	Flag for including stress resultants in the shell LS-DYNA database: EQ.1: include (default), EQ.2: exclude.
ENGFLG	Flag for including shell internal energy density and thickness in the LS-DYNA database: EQ.1: include (default), EQ.2: exclude.
IEVERP	Every plot state for “d3plot” database is written to a separate file. This option will limit the database to 1000 states: EQ.0: more than one state can be on each plot file, EQ.1: one state only on each plot file.
SHGE	Output shell hourglass energy density: EQ.1: off (default), no hourglass energy written, EQ.2: on.
STSSZ	Output shell element time step, mass, or added mass: EQ.1: off (default), EQ.2: output time step size,
STSSZ	Output shell element time step, mass, or added mass: EQ.1: off (default), EQ.2: output time step size, EQ.3: output mass, added mass, or time step size. See remark 3 below.
NINTSLD	Number of solid element integration points written to the LS-DYNA database. The default value is 1. For solids with multiple integration points NINTSLD may be set to 8. Currently, no other values for NINTSLD are allowed. For solids with multiple integration points, an average value is output if NINTSLD is set to 1.

INTFOR option:

For the INTFOR option the following card applies:

Card 1            1            2            3            4            5            6            7            8

Variable	NGLBV	NVELO	NPRESU	NSHEAR	NFORC	NGAPC		IEVERF
Type	I	I	I	I	I	I		I
Default	1	1	1	1	1	1		0
Remarks								

**VARIABLE****DESCRIPTION**

NGLBV	Output global variables: EQ.-1: no, EQ.1: yes (default).
NVELO	Output nodal velocity: EQ.-1: no, EQ.1: yes (default).
NPRESU	Output pressures: EQ.-1: no, EQ.1: normal interface pressure (default), EQ.2: normal interface pressure and peak pressure, EQ.3: normal interface pressure, peak pressure and time to peak.
NSHEAR	Output shear stresses: EQ.-1: no, EQ.1: shear stress in r-direction and s-direction (default).
NFORC	Output forces: EQ.-1: no, EQ.1: x-, y-, z-force at all nodes (default).
NGAPC	Output contact gaps at all nodes and surface energy density EQ.-1: no, EQ.1: yes (default).



<u>VARIABLE</u>	<u>DESCRIPTION</u>
IEVERF	Every interface force state for the “intfor” database is written to a separate file: EQ.0: more than one interface force state can be on each intfor file, EQ.1: one interface force output state only on each intfor file.

SSSTAT option:

**For the SSSTAT option the following card(s) apply:**

**Define as many cards as necessary.**

**(Define one part set ID for each subsystem. Use as many cards as necessary.)**

Card            1            2            3            4            5            6            7            8

Variable	PSID1	PSID2	PSID3	PSID4	PSID5	PSID6	PSID7	PSID8
Type	I	I	I	I	I	I	I	I

<u>VARIABLE</u>	<u>DESCRIPTION</u>
PSIDn	Part set ID for subsystem n.; see *SET_PART.

**Remarks:**

1. If MAXINT is set to 3 then mid-surface, inner-surface and outer-surface stresses are output at the center of the element to the LS-DYNA database. For an even number of integration points, the points closest to the center are averaged to obtain the midsurface values. If multiple integration points are used in the shell plane, the stresses at the center of the element are found by computing the average of these points. For MAXINT equal to 3 LS-DYNA assumes that the data for the user defined integration rules are ordered from bottom to top even if this is not the case. If MAXINT is not equal to 3, then the stresses at the center of the element are output in the order that they are stored for the selected integration rule. If multiple points are used in plane the stresses are first averaged.
2. Beam stresses are output to the LS-DYNA database if and only if BEAMIP is greater than zero. In this latter case the data that is output is written in the same order that the integration points are defined. The data at each integration point consists of the following five values for elastic-plastic Hughes-Liu beams: the normal stress,  $\sigma_{rr}$ ; the transverse shear stresses,  $\sigma_{rs}$  and  $\sigma_{tr}$ ; the effective plastic strain, and the axial strain which is logarithmic. For beams that are not elastic-plastic, the first history variable, if

any, is output instead of the plastic strain. For the beam elements of Belytschko and his co-workers, the transverse shear stress components are not used in the formulation. No data is output for the Belytschko-Schwer resultant beam.

3. If mass scaling is active, the output of the time step size reveals little information about the calculation. If global mass scaling is used for a constant time step, the total element mass is output; however, if the mass is increased so that a minimum time step size is maintained (DT2MS is negative), the added mass is output. Also, see the control card \*CONTROL\_TIMESTEP.
4. Output coordinate system used. When the parameters: INTOUT or NODOUT is set to STRESS, STRAIN, or ALL, the output coordinate system the data, similar to the file ELOUT, is determined by "cmpflg", the 1<sup>st</sup> column of the 2<sup>nd</sup> card in \*DATABASE\_EXTENT\_BINARY.
5. Nodal output when NODOUT=STRESS, STRAIN, or ALL. Each node of the element nodal connectivity will be output.

Example 1:

ELOUTDET for an shell elem. of two, 2, through-thickness integration points and four, 4, in-plane integration points, with INTOUT=STRESS and NODOUT=STRESS

element materl

ipt	stress	sig-xx	sig-yy	sig-zz	sig-xy	sig0yz	sig-zx	yield	location
1-	1								
1- 10	elastic	4.4104E-02	2.5141E-01	0.0000E+00	7.7640E-08	0.0000E+00	0.0000E+00	0.0000E+00	int. point 1
1- 10	elastic	4.4104E-02	2.5141E-01	0.0000E+00	7.7640E-08	0.0000E+00	0.0000E+00	0.0000E+00	int. point 2
1- 10	elastic	4.4104E-02	2.5141E-01	0.0000E+00	7.7640E-08	0.0000E+00	0.0000E+00	0.0000E+00	int. point 3
1- 10	elastic	4.4104E-02	2.5141E-01	0.0000E+00	7.7640E-08	0.0000E+00	0.0000E+00	0.0000E+00	int. point 4
1- 10	elastic	4.4104E-02	2.5141E-01	0.0000E+00	7.7640E-08	0.0000E+00	0.0000E+00	0.0000E+00	node 21
1- 10	elastic	4.4104E-02	2.5141E-01	0.0000E+00	7.7640E-08	0.0000E+00	0.0000E+00	0.0000E+00	node 22
1- 10	elastic	4.4104E-02	2.5141E-01	0.0000E+00	7.7640E-08	0.0000E+00	0.0000E+00	0.0000E+00	node 20
1- 10	elastic	4.4104E-02	2.5141E-01	0.0000E+00	7.7640E-08	0.0000E+00	0.0000E+00	0.0000E+00	node 19
2- 10	elastic	4.4104E-02	2.5141E-01	0.0000E+00	7.7640E-08	0.0000E+00	0.0000E+00	0.0000E+00	int. point 1
2- 10	elastic	4.4104E-02	2.5141E-01	0.0000E+00	7.7640E-08	0.0000E+00	0.0000E+00	0.0000E+00	int. point 2
2- 10	elastic	4.4104E-02	2.5141E-01	0.0000E+00	7.7640E-08	0.0000E+00	0.0000E+00	0.0000E+00	int. point 3
2- 10	elastic	4.4104E-02	2.5141E-01	0.0000E+00	7.7640E-08	0.0000E+00	0.0000E+00	0.0000E+00	int. point 4
2- 10	elastic	4.4104E-02	2.5141E-01	0.0000E+00	7.7640E-08	0.0000E+00	0.0000E+00	0.0000E+00	node 21
2- 10	elastic	4.4104E-02	2.5141E-01	0.0000E+00	7.7640E-08	0.0000E+00	0.0000E+00	0.0000E+00	node 22
2- 10	elastic	4.4104E-02	2.5141E-01	0.0000E+00	7.7640E-08	0.0000E+00	0.0000E+00	0.0000E+00	node 20
2- 10	elastic	4.4104E-02	2.5141E-01	0.0000E+00	7.7640E-08	0.0000E+00	0.0000E+00	0.0000E+00	node 19

6. Nodal output when NODOUT=STRESS\_GL, STRAIN\_GL, or ALL\_GL. Averaged nodal results are calculated by summing up all contributions from elements sharing the common node, and then dividing the total by the number of contributing elements. Averaged nodal values are always output in the global coordinate system.

Example 2:

ELOUTDET for averaged nodal strain

nodal strain calculations for time step 24 ( at time 9.89479E+01 )

node (global) strain	eps-xx	eps-yy	eps-zz	eps-xy	eps-yz	eps-zx
1-						
lower surface	2.0262E-01	-2.6058E-02	-7.5669E-02	-5.1945E-03	0.0000E+00	0.0000E+00
upper surface	2.0262E-01	-2.6058E-02	-7.5669E-02	-5.1945E-03	0.0000E+00	0.0000E+00
2-						
lower surface	1.9347E-01	2.3728E-04	-8.3019E-02	-1.4484E-02	0.0000E+00	0.0000E+00
upper surface	1.9347E-01	2.3728E-04	-8.3019E-02	-1.4484E-02	0.0000E+00	0.0000E+00
3-						
lower surface	2.0541E-01	-5.7521E-02	-6.3383E-02	-1.7668E-03	0.0000E+00	0.0000E+00
upper surface	2.0541E-01	-5.7521E-02	-6.3383E-02	-1.7668E-03	0.0000E+00	0.0000E+00
4-.....						

7. Available stress/strain components in eloutdet stress components includes 6 stress components (sig-xx, sig-yy, sig-zz, sig-xy, sig-yz, sig-zx), yielding status, and effective plastic strain. Strain components includes 6 strain components
8. Shell element output at integration point: stresses at all integration points can be output. The strain at the top and bottom integration layer can be output. At a connective node the extrapolated stress and strain at the top and bottom layer can be output
9. Thick shell element output includes the six stress components at each integration point. Strain at the top and bottom layer can be output. At the element node, values at the bottom layer are extrapolated to yield the values of nodes 1-4, and values at the top layer are extrapolated to yield values of nodes 5-8.
10. Solid element output at integration point: stresses and strain at all integration points can be output. For the nodal points, values at the integration points are extrapolated.

**\*DATABASE\_FORMAT**

Purpose: Define the output format for binary files.

Card            1            2            3            4            5            6            7            8

Variable	IFORM	IBINARY						
Type	I	I						
Default	0	0						
Remarks	1	2						

**VARIABLE****DESCRIPTION**

IFORM

Output format for D3PLOT and D3THDT files  
 EQ.0: LS-DYNA database format (default),  
 EQ.1: ANSYS database format,  
 EQ.2: Both LS-DYNA and ANSYS database formats.

IBINARY

Word size of the binary output files (D3PLOT, D3THDT, D3DRLF and interface files for 64 bit computer such as CRAY and NEC.  
 EQ.0: default 64 bit format,  
 EQ.1: 32 bit IEEE format

**Remarks:**

1. This option is not available for every platform. Check LS-DYNA Banner upon execution of the program
2. By using this option one can reduce the size of the binary output files which are created by 64 bits computer such as CRAY and NEC.

**\*DATABASE\_FREQUENCY\_BINARY\_OPTION**

Options for frequency domain binary output files with the default names given include:

- D3ACS** Binary output file for FEM acoustics (acoustic pressure and sound pressure level). See also \*FREQUENCY\_DOMAIN\_ACOUSTIC\_FEM.
- D3FTG** Binary output file for random vibration fatigue analysis. See also \*FREQUENCY\_DOMAIN\_RANDOM\_VIBRATION\_FATIGUE.
- D3PSD** Binary Power Spectral Density output file for random vibration analysis. See also \*FREQUENCY\_DOMAIN\_RANDOM\_VIBRATION.
- D3RMS** Binary Root Mean Square output file for random vibration analysis. See also \*FREQUENCY\_DOMAIN\_RANDOM\_VIBRATION.
- D3SPCM** Binary output file for response spectrum analysis. See also \*FREQUENCY\_DOMAIN\_RESPONSE\_SPECTRUM.
- D3SSD** Binary output file for steady state dynamics. See also \*FREQUENCY\_DOMAIN\_SSD.

The D3ACS, D3FTG, D3PSD, D3RMS, D3SPCM and D3SSD files contain plotting information to plot data over the three dimensional geometry of the model. These databases can be plotted with LS-PREPOST. The D3PSD file contains PSD state data for a range of frequencies. The D3SSD file contains state data for a range of frequencies. For D3SSD, the data can be real or complex, depending on the variable BINARY defined below. The D3ACS file contains acoustic results including acoustic pressure and sound pressure level for a range of frequencies, which are defined in the keyword \*FREQUENCY\_DOMAIN\_ACOUSTIC\_FEM. The D3FTG, D3RMS and D3SPCM files contain only one state each as they are the data for cumulative fatigue damage ratio, root mean square for random vibration and peak response for response spectrum analysis separately.

Card	1	2	3	4	5	6	7	8
------	---	---	---	---	---	---	---	---

Variable	BINARY							
Type	I							
Default	-							
Remarks	1							

**Optional Card that only applies to D3PSD and D3SSD database.**

Card                    1                    2                    3                    4                    5                    6                    7                    8

Variable	FMIN	FMAX	NFREQ	FSPACE	LCFREQ			
Type	F	F	I	I	I			
Default	0.0	0.0	0	0	0			

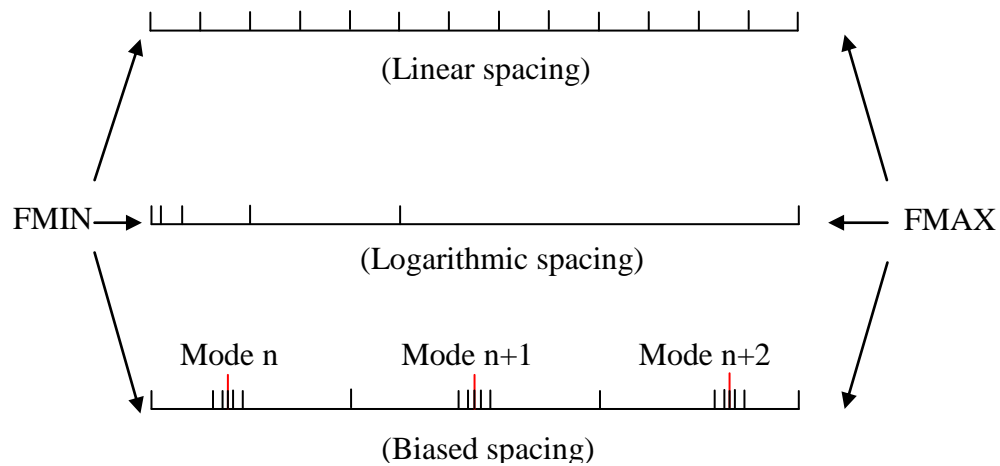
**VARIABLE****DESCRIPTION**

BINARY	Flag for writing the binary plot file. EQ.0: Off EQ.1: write the binary plot file EQ.2: write the complex variable binary plot file (D3SSD only)
FMIN	Minimum frequency for output (cycles/time)
FMAX	Maximum frequency for output (cycles/time).
NFREQ	Number of frequencies for output.
FSPACE	Frequency spacing option for output: EQ.0: linear, EQ.1: logarithmic, EQ.2: biased,
LCFREQ	Load Curve ID defining the frequencies for output.

**Remarks:**

- For OPTION=D3SSD, If BINARY=1, only the magnitude of the displacement and stress response is written into the binary database "d3ssd" which can be accessed by LS-PREPOST 3.0 or older versions. For customers using LS-PREPOST 3.0 or older versions, it is suggested to set BINARY=1. If BINARY=2, both the magnitude and the phase angle of the response are written into "d3ssd" so that LS-PREPOST (3.1 or higher versions) can run modal expansion (to show the cyclic time history fringe plot) on each output frequency.
- There are two methods to define the output frequencies.
  - The first method is to define FMIN, FMAX, NFREQ and FSPACE. FMIN and FMAX specify the frequency range of interest and NFREQ specifies the number of

frequencies at which results are required. FSPACE specifies the type of frequency spacing (linear, logarithmic or biased) to be used. These frequency points for which results are required can be spaced equally along the frequency axis (on a linear or logarithmic scale). Or they can be biased toward the eigenfrequencies (the frequency points are placed closer together at eigenfrequencies in the frequency range) so that the detailed definition of the response close to resonance frequencies can be obtained.



**Figure 12.2** Spacing options of the frequency points

- The second method is to use a load curve (LCFREQ) to define the frequencies of interest.

## \*DATABASE\_FSI

Purpose: This card may be used to output information about certain coupled Lagrangian surfaces. The Lagrangian shell/segment entity to be monitored (SID) must be included in (or part of) the slave set in a \*CONSTRAINED\_LAGRANGE\_IN\_SOLID (CLIS) card. \*DATABASE\_FSI activates the output of an ASCII file called "dbfsi". This file contains some coupling information (force, pressure, accumulated mass flowing across some monitoring surfaces, etc.) for the coupled Lagrangian surface. This card should only be used for penalty coupling type in CLIS card (does not work with constrained-based coupling).

Card 1            1            2            3            4            5            6            7            8

Variable	DTOUT							
Type	F							

### Define one surface per card

Card 2,3,...    1            2            3            4            5            6            7            8

Variable	DBFSI_ID	SID	SIDTYPE	SWID	CONVID			
Type	I	I	I	I	I			

<u>VARIABLE</u>	<u>DESCRIPTION</u>
DTOUT	Output interval time step
DBFSI_ID	Surface ID (for reference purposes only) or a DATABASE_FSI entity ID. It consists of a geometric entity defined by the SID below.
SID	Set ID defining the geometrical surface(s) through which or upon which some data is to be tracked and output to a file called "dbfsi". This set ID can be a (1) PID or (2) PSID or (3) SGSID. This Lagrangian SID must be contained in a Lagrangian slave SID defined in a corresponding coupling card, *CONSTRAINED_LAGRANGE_IN_SOLID.
SIDTYPE	Set type: EQ.0: Part set EQ.1: Part EQ.2: Segment set



---

<u>VARIABLE</u>	<u>DESCRIPTION</u>
SWID	This is an ID from a corresponding *ALE_FSI_SWITCH_MMG_ID card. This card allows for the AMMG ID of an ALE material to be switched as it passes across a monitoring surface. If defined, the accumulative mass of the “switched” ALE multi-material group (AMMG) is written out under the “mout” parameter in the “dbfsi” file.
CONVID	This is used mostly for airbag application only: CONVID is an ID from a corresponding *LOAD_ALE_CONVECTION_ID card which computes the heat transfer between inflator gas (ALE material) and the inflator canister (Lagrangian part). If defined, the temperature of the Lagrangian part having heat transfer with the gas, and its change in temperature as function of time are output in the “dbfsi” file.

**Remarks:**

1. When a Lagrangian mesh overlaps with an Eulerian or ALE mesh, the fluid-structure (or ALE-Lagrangian) interaction may be modeled via a \*CONSTRAINED\_LAGRANGE\_IN\_SOLID (CLIS) card. This database command allows for the monitoring of certain coupling information related to the flow across, and the load on some selected Lagrangian surfaces defined in corresponding CLIS card.
2. The dbfsi parameters output are defined in the following (with metric units shown just for clarification):

- pres = Averaged estimated coupling pressure over each surface entity being monitored (Pa).
- fx,fy,fz = Averaged total estimated coupling force components (N) along the global coordinate directions, over each surface entity defined, and acting at the centroid of each surface.
- mout = Accumulated **mass** (Kg) passing through each DBFS\_ID surface entity. See remark 3 below. (This parameter used to be called “pleak”).
- obsolete = (This parameter used to be called “mflux”).
- gx,gy,gz = Average estimated x|y|z leakage-control force component over the surface entity. This is used for debugging only. Too high leakage control forces (relative to the main coupling forces, fx, fy and fz) may indicate that alternate coupling approach should be considered since the main coupling force is putting out too little resistance to leakage. (These parameters used to be called fx-lc, fy-lc and fz-lc).

Ptmp = Lagrangian part Temperature (Activated only when the \*LOAD\_ALE\_CONVECTION card is used).

PDt = Lagrangian part Temperature change (Activated only when the \*LOAD\_ALE\_CONVECTION card is used).

3. **“mout”** parameter in the “dbfsi” output from this keyword contains the accumulated **mass** (Kg) passing through each DBFS\_ID surface entity. For 4 different cases:
  - a) When LCIDPOR is defined in the coupling card (CLIS), porous accumulated mass transport across a Lagrangian shell surface may be monitored and output in **“mout”**.
  - b) Porous flow across Lagrangian shell may also be defined via a load curve in the \*MAT\_FABRIC card, and similar result will be tracked and output. This is an alternate form of (a).
  - c) When NVENT in the CLIS card is defined (isentropic venting), the venting mass transport across the isentropic vent hole surface may be output in **“mout”**.
  - d) When an \*ALE\_FSI\_SWITCH\_MMG\_ID card is defined, and the SWID parameter specifies this ID to be tracked, then the amount of accumulated mass that has been switched when passing across a monitoring surface is output.

### **Example:**

Consider a model with a Lagrangian mesh overlaps with an Eulerian or ALE mesh. On the Lagrangian mesh, there are 3 Lagrangian surface sets over which some data is to be written out.

```

$...|...1...|...2...|...3...|...4...|...5...|...6...|...7...|...8
$ INPUT:
$...|...1...|...2...|...3...|...4...|...5...|...6...|...7...|...8
*DATABASE_FSI
$      dt
  2.97E-06
$ DBFSI_ID      SID      STYPE      swid      convid [STYPE: 0=PSID;1=PID;2=SGSID]
      11          1          2
      12          2          2
      13          3          1
$...|...1...|...2...|...3...|...4...|...5...|...6...|...7...|...8
$ This reads:
$ DBFSI_ID 11 is defined by a SID=1: a SGSID = as specified by STYPE=2
$ DBFSI_ID 12 is defined by a SID=2: a SGSID = as specified by STYPE=2
$ DBFSI_ID 13 is defined by a SID=3: a PID = as specified by STYPE=1
$...|...1...|...2...|...3...|...4...|...5...|...6...|...7...|...8
$ An OUTPUT file called "dbfsi" looks like the following:

```

```
$...|...1...|...2...|...3...|...4...|...5...|...6...|...7...|...8
Fluid-structure interaction output
Number of surfaces:      3

      id      pres      fx      fy      fz      mout
      obsolete      gx      gy      gz      Ptmp
Pdt
      time= 0.00000E+00
11  0.0000E+00  0.0000E+00  0.0000E+00  0.0000E+00  0.0000E+00
    0.0000E+00  0.0000E+00  0.0000E+00  0.0000E+00  0.0000E+00
0.0000E+00
12  0.0000E+00  0.0000E+00  0.0000E+00  0.0000E+00  0.0000E+00
    0.0000E+00  0.0000E+00  0.0000E+00  0.0000E+00  0.0000E+00
0.0000E+00
13  0.0000E+00  0.0000E+00  0.0000E+00  0.0000E+00  0.0000E+00
    0.0000E+00  0.0000E+00  0.0000E+00  0.0000E+00  0.0000E+00
0.0000E+00
      time= 0.29709E-05
11  0.0000E+00  0.0000E+00  0.0000E+00  0.0000E+00  0.0000E+00
    0.0000E+00  0.0000E+00  0.0000E+00  0.0000E+00  0.0000E+00
0.0000E+00
12  0.0000E+00  0.0000E+00  0.0000E+00  0.0000E+00  0.0000E+00
    0.0000E+00  0.0000E+00  0.0000E+00  0.0000E+00  0.0000E+00
0.0000E+00
13  0.0000E+00  0.0000E+00  0.0000E+00  0.0000E+00  0.0000E+00
    0.1832E-06  0.0000E+00  0.0000E+00  0.0000E+00  0.0000E+00
0.0000E+00
$...|...1...|...2...|...3...|...4...|...5...|...6...|...7...|...8
```

**\*DATABASE\_FSI\_SENSOR**

Purpose: This card activates the output of an ASCII file called “dbsensor”. Its input defines the pressure sensors’ locations which follow the positions of some Lagrangian segments during the simulation. Its ASCII output file, dbsensor, contains the spatial position of the sensor and its recorded pressure from the ALE elements containing the sensors. This card is activated when a \*CONSTRAINED\_LAGRANGE\_IN\_SOLID card is used and the Lagrangian shell elements defining the locations of the sensors must be included in the slave or structure coupling set.

Card 1            1            2            3            4            5            6            7            8

Variable	DT							
Type	F							

**Card(s) 2+ Format: Define one surface per line**

Card 2,3,...    1            2            3            4            5            6            7            8

Variable	DBFSI_ID	NID	SEGMID	OFFSET				
Type	I	I	I	F				

**VARIABLE****DESCRIPTION**

DT	Output interval
DBFSI_ID	Pressure-Sensor ID.
NID	An optional Lagrangian node ID defining an approximate pressure sensor location with respect to a Lagrangian shell element. This is not a required input.
SEGMID	A required Lagrangian shell element ID for locating the pressure sensor. If NID=0 or blank, the sensor will be automatically placed in the center of this SEGMID, accounting for the offset distance.
OFFSET	Offset distance between the pressure sensor and the Lagrangian segment surface. If it is positive, it is on the side pointed to by the segment normal vector and vice versa.

Remarks:

1. The output parameters in the “dbsensor” ASCII file are:

ID = Sensor ID.

x,y,z = Sensor spatial location.

P = Sensor recorded pressure (Pa) from the ALE fluid element containing the sensor.

For example to plot the sensor pressure in LS-Prepost, select:

ASCII → dbsensor → LOAD → (select sensor ID) → Pressure → PLOT

Example 1:

```

$...|...1...|...2...|...3...|...4...|...5...|...6...|...7...|...8
$ INPUT:
$...|...1...|...2...|...3...|...4...|...5...|...6...|...7...|...8
*DATABASE_FSI_SENSOR
  0.01
$ DBFSI_ID      NID SEGMENTID  OFFSET
   10          360      355      -0.5
   20          396      388      -0.5
   30          324      332      -0.5
$...|...1...|...2...|...3...|...4...|...5...|...6...|...7...|...8
$ The 1st line reads:
$ SENSOR_ID 10 is located by segment-ID=355. Node-ID=360 precisely locate this
$ sensor (if NID=0, then the sensor is located at the segment center). This
$ sensor is located 0.5 length unit away from the segment surface. Negative
$ sign indicates a direction opposite to the segment normal vector.
$...|...1...|...2...|...3...|...4...|...5...|...6...|...7...|...8
$ An OUTPUT file called "dbsensor" looks like the following:
$...|...1...|...2...|...3...|...4...|...5...|...6...|...7...|...8
  ALE sensors output
  Number of sensors:  3

      id          x          y          z          p
  time= 0.17861E-02
  10  0.0000E+00  0.0000E+00  -0.3900E+00  0.1085E-03
  20 -0.2250E+02  0.2250E+02  -0.3900E+00  0.1085E-03
  30  0.2250E+02 -0.2250E+02  -0.3900E+00  0.1085E-03
  time= 0.20081E-02
  10  0.0000E+00  0.0000E+00  -0.3900E+00  0.1066E-03
  20 -0.2250E+02  0.2250E+02  -0.3900E+00  0.1066E-03
  30  0.2250E+02 -0.2250E+02  -0.3900E+00  0.1066E-03
$...|...1...|...2...|...3...|...4...|...5...|...6...|...7...|...8
$ ID      = DBFSI_ID
$ x,y,z   = Sensor location (defined based on a Lagrangian segment)
$ p       = Sensor pressure as taken from the fluid element containing the sensor.
$...|...1...|...2...|...3...|...4...|...5...|...6...|...7...|...8

```

**\*DATABASE\_HISTORY\_OPTION**

Available options include:

**BEAM**  
**BEAM\_SET**  
**BEAM\_ID**  
**DISCRETE**  
**DISCRETE\_ID**  
**DISCRETE\_SET**  
**NODE**  
**NODE**  
**NODE\_ID**  
**NODE\_LOCAL**  
**NODE\_LOCAL\_ID**  
**NODE\_SET**  
**NODE\_SET\_LOCAL**  
**SEATBELT**  
**SEATBELT\_ID**  
**SHELL**  
**SHELL\_ID**  
**SHELL\_SET**  
**SOLID**  
**SOLID\_ID**  
**SOLID\_SET**  
**SPH**  
**SPH\_SET**  
**TSHELL**  
**TSHELL\_ID**  
**TSHELL\_SET**

Purpose: Control which nodes or elements are output into the binary history file, D3THDT, the ASCII file NODOUT, the ASCII file ELOUT and the ASCII file SPHOUT. Define as many cards as necessary. The next "\*" card terminates the input. See also \*DATABASE\_BINARY\_OPTION and \*DATABASE\_OPTION.







---

<u>VARIABLE</u>	<u>DESCRIPTION</u>
	ASCII database NODOUT.

**Remarks:**

1. If a node belongs to an accelerometer, see \*ELEMENT\_SEATBELT\_ACCELEROMETER, and if it also appears as an active node in the NODE\_LOCAL or NODE\_SET\_LOCAL keyword, the coordinate system, CID, transformations will be skipped and the LOCAL option will have no effect.

**\*DATABASE\_MASSOUT**

Purpose: Output nodal masses into ASCII file MASSOUT.

Card            1            2            3            4            5            6            7            8

Variable	SETID	NDFLG	RBFLG					
Type	I	I	I					
Default	0	1	0					

**VARIABLE****DESCRIPTION**

SETID	Optional set ID. EQ.0: mass output for all nodes, LT.0: no output, GT.0: set ID identifying nodes whose mass will be output.
NDFLG	Database extent: EQ.1: output translational mass for nodes identified by SETID (default), EQ.2: output translational mass and rotary inertias for the nodes identified by the SETID.
RBFLG	Rigid body data: EQ.0: no output for rigid bodies, EQ.1: output rigid body mass and inertia.

**Remarks:**

- Nodes and rigid bodies with no mass are not output. By inference, when the set ID is zero and no output shows up for a node, then the mass of that node is zero.

**\*DATABASE\_NODAL\_FORCE\_GROUP**

Purpose: Define a nodal force group for output into ASCII file NODFOR and the binary file XTFIL. See also \*DATABASE\_OPTION and \*DATABASE\_BINARY\_OPTION.

Card            1            2            3            4            5            6            7            8

Variable	NSID	CID						
Type	I	I						
Default	none	none						

<u>VARIABLE</u>	<u>DESCRIPTION</u>
NSID	Nodal set ID, see *SET_NODE_OPTION.
CID	Coordinate system ID for output of data in local system,

**Remarks:**

1. The reaction forces in the global x, y, and z directions (and local x, y, and z directions if CID is defined above) for the nodal force group are written to the NODFOR file (see \*DATABASE\_NODFOR) along with the external work done by these reaction forces. The reaction forces in the global x, y, and z directions for each node in the nodal force group are also written to NODFOR. These forces can be a result of applied boundary forces such as nodal point forces and pressure boundary conditions, body forces, and contact interface forces. In the absence of body forces, interior nodes would always yield a null force resultant vector. In general this option would be used for surface nodes.

# \*DATABASE

# \*DATABASE\_PROFILE

## \*DATABASE\_PROFILE

Purpose: Plot the distribution or profile of a data along x, y, or z-direction.

Card            1            2            3            4            5            6            7            8

Variable	DT	ID	TYPE	DATA	DIR			
Type	I	I	I	I	I			
Default	none	none	none	none	none			

### VARIABLE

### DESCRIPTION

DT	Interval time.
ID	Set ID.
TYPE	Set type: EQ.1: Node Set, EQ.2: Solid Set, EQ.3: Shell Set, EQ.4: Segment Set.
DATA	Data type: EQ.1: x-velocity, EQ.2: y-velocity, EQ.3: z-velocity, EQ.4: velocity magnitude, EQ.5: x-acceleration, EQ.6: y-acceleration, EQ.7: z-acceleration, EQ.8: acceleration magnitude, EQ.9: pressure, EQ.10: xx-stress, EQ.11: yy-stress, EQ.12: zz-stress, EQ.13: xy-stress, EQ.14: yz-stress, EQ.15: zx-stress, EQ.16: temperature.

---

<u>VARIABLE</u>	<u>DESCRIPTION</u>
DIR	Direction: EQ.1: x-direction, EQ.2: y-direction, EQ.3: z-direction,

**Remarks:**

1. At a given time T the profile is written in a file named profile\_DATA\_DIR\_timeT.xy (DATA and DIR are replaced by the data and direction names respectively). The file has a xyplot format that lsprepost can read and plot. For example, DATA=9, DIR=2 and DT=0.1sec will save a pressure profile at t=0.0sec in profile\_pressure\_y\_time0.0.xy, at t=0.1sec in profile\_pressure\_y\_time0.1.xy, at t=0.2sec in profile\_pressure\_y\_time0.2.xy, ...

**\*DATABASE\_PWP\_FLOW**

Purpose: Request output containing nett inflow of fluid at a set of nodes.

Card 1            1            2            3            4            5            6            7            8

Variable	NSET								
Type	I								
Default	0								

**VARIABLE****DESCRIPTION**

NSET

Node set ID

**Remarks:**

Any number of these cards can be used. Nett inflow or outflow arises when maintaining an applied PWP boundary condition implies addition or removal of water.

Output is written to a file named database\_pwp\_flow.csv, a comma-separated ascii file. Each line consists of (time, flow1, flow2...) where flow1 is the total inflow at the node set for the first DATABASE\_PWP\_FLOW request, flow2 is for the second, etc.

**\*DATABASE\_PWP\_OUTPUT**

Purpose: Set contents of output files for pore pressure calculations.

Card 1            1            2            3            4            5            6            7            8

Variable	IVEL	IACCX	IACCY	IACCZ	NCYOUT			
Type	I	I	I	I	I			
Default	0	0	0	0	100			

<u>VARIABLE</u>	<u>DESCRIPTION</u>
IVEL	Meaning of “Velocity” in d3plot and d3thdt output files 0: Nodal velocity vector 1: Seepage velocity vector
IACCX,Y,Z	Meaning of “X/Y/Z-Acceleration” in d3plot and d3thdt output files 0: Not written 1: Total pwp head 2: Excess pwp head (this is also written as temperature) 3: Target rate of volume change 4: Actual rate of volume change 7: Hydraulic pwp head 8: Error in rate of volume change (calculated from seepage minus actual) 9: Volume at node 10: Rate of volume change calculated from seepage 14: Void volume (generated at suction limit) 17: NFIXCON (e.g. +4/-4 for nodes on suction limit)
NCYOUT	Number of cycles between outputs of calculation status to d3hsp, log, and tdc_control_output.csv files (time-dependent and steady-state analysis types)

**\*DATABASE\_PAP\_OUTPUT**

Purpose: Set contents of output files for pore air pressure calculations.

Card 1            1            2            3            4            5            6            7            8

Variable	IVEL	IACCX	IACCY	IACCZ	NCYOUT			
Type	I	I	I	I	I			
Default	0	0	0	0	100			

**VARIABLE****DESCRIPTION**

IVEL	Meaning of "Velocity" in d3plot and d3thdt output files 0: Nodal velocity vector 1: Seepage velocity vector
IACCX,Y,Z	Meaning of "X/Y/Z-Acceleration" in d3plot and d3thdt output files 0: Not written 21: Nodal air density 22: Nodal pore air pressure 24: Nodal air mass 25: Nodal air mass flow rate
NCYOUT	Number of cycles between outputs of calculation status to d3hsp and log files



**\*DATABASE\_SPRING\_FORWARD**

Purpose: Create spring forward nodal force file. This option is to output resultant nodal force components of sheet metal at the end of the forming simulation into an ASCII file, "SPRING-FORWARD", for spring forward and die corrective simulations.

Card            1            2            3            4            5            6            7            8

Variable	IFLAG							
Type	I							

**VARIABLE**

**DESCRIPTION**

IFLAG

Output type:  
EQ.0: off,  
EQ.1: output element nodal force vector for deformable nodes.

# \*DATABASE

## \*DATABASE\_SUPERPLASTIC\_FORMING

### \*DATABASE\_SUPERPLASTIC\_FORMING

Purpose: Specify the output intervals to the superplastic forming output files. The option \*LOAD\_SUPERPLASTIC\_FORMING must be active.

Card            1            2            3            4            5            6            7            8

Variable	DTOUT							
Type	F							

#### VARIABLE

#### DESCRIPTION

DTOUT

Output time interval for output to “pressure”, “curve1” and “curve2” files. The “pressure” file contains general information from the analysis and the files “curve1” and “curve2” contain pressure versus time from phases 1 and 2 of the analysis. The data in the pressure and curve files may be plotted using ASCII > superpl in LS-Prepost.

**\*DATABASE\_TRACER**

Purpose: Tracer particles will save a history of either a material point or a spatial point into an ASCII file, TRHIST. This history includes positions, velocities, and stress components. The option \*DATABASE\_TRHIST must be active. This option applies to ALE and SPH problems.

Card            1            2            3            4            5            6            7            8

Variable	TIME	TRACK	X	Y	Z	AMMGID	NID	
Type	F	I	F	F	F	I	I	
Default	0.0	0	0	0	0	0	0	

**VARIABLE****DESCRIPTION**

TIME	Start time for tracer particle
TRACK	Tracking option: EQ.0: particle follows material, EQ.1: particle is fixed in space.
X	Initial x-coordinate
Y	Initial y-coordinate
Z	Initial z-coordinate
AMMGID	The AMMG ID (ALE multi-material group) of the material being tracked in a multi-material ALE element. See remark 1.
NID	A node ID (of a massless dummy node) defining the initial position of a tracer particle. If defined, its coordinates will overwrite the x-y-z definitions above. This feature is for TRACK=0 (Lagrangian tracer) option only. See remark 2.

**Remarks:**

1. ALE element can contain multi-materials. Each is referred to as an ALE multi-material group or AMMG. Each AMMG has its list of history variables that can be output. For example, if a tracer is in a mixed element consisting of 2 AMMGs, and the history variables of AMMG 1 are to be output or tracked, the AMMGID should be defined as

AMMGID=1. If AMMGID=0, a volume-fraction-weighted-averaged pressure will be reported instead.

2. If massless node's NID is nonzero, its initial coordinate position overwrites the x-y-z definitions, and its location will be tracked throughout the computation as it moves with the material in the element it currently resides.
3. If "BINARY=2 or 3" under \*DATABASE\_TRHIST the output to \*DATABASE\_TRACER will be written to a file like "binout0000". To access the output in LS-PREPOST: [TAB 2] → [LOAD] → [binout0000] → [trhist] → "Trhist Data" window contains a list of variables output for each tracer.

# **\*DEFINE**

The keyword \*DEFINE provides a way of defining boxes, coordinate systems, load curves, tables, and orientation vectors for various uses. The keyword cards in this section are defined in alphabetical order:

- \*DEFINE\_ALEBAG\_BAG**
- \*DEFINE\_ALEBAG\_HOLE**
- \*DEFINE\_ALEBAG\_INFLATOR**
- \*DEFINE\_BOX**
- \*DEFINE\_BOX\_ADAPTIVE**
- \*DEFINE\_BOX\_COARSEN**
- \*DEFINE\_BOX\_DRAWBEAD**
- \*DEFINE\_BOX\_SPH**
- \*DEFINE\_CONNECTION\_PROPERTIES\_{OPTION}**
- \*DEFINE\_CONSTRUCTION\_STAGES**
- \*DEFINE\_CONTACT\_VOLUME**
- \*DEFINE\_COORDINATE\_NODES**
- \*DEFINE\_COORDINATE\_SYSTEM**
- \*DEFINE\_COORDINATE\_VECTOR**
- \*DEFINE\_CURVE\_{OPTION}**
- \*DEFINE\_CURVE\_COMPENSATION**
- \*DEFINE\_CURVE\_DRAWBEAD**
- \*DEFINE\_CURVE\_DUPLICATE**
- \*DEFINE\_CURVE\_ENTITY**
- \*DEFINE\_CURVE\_FEEDBACK**
- \*DEFINE\_CURVE\_FUNCTION**
- \*DEFINE\_CURVE\_SMOOTH**
- \*DEFINE\_CURVE\_TRIM\_{OPTION}**
- \*DEFINE\_DEATH\_TIMES\_{OPTION}**
- \*DEFINE\_ELEMENT\_DEATH\_{OPTION}**
- \*DEFINE\_ELEMENT\_GENERALIZED\_SHELL**

# **\*DEFINE**

---

**\*DEFINE\_ELEMENT\_GENERALIZED\_SOLID**  
**\*DEFINE\_FRICTION**  
**\*DEFINE\_FUNCTION**  
**\*DEFINE\_FUNCTION\_TABULATED**  
**\*DEFINE\_HEX\_SPOTWELD\_ASSEMBLY\_{OPTION}**  
**\*DEFINE\_SD\_ORIENTATION**  
**\*DEFINE\_SET\_ADAPTIVE**  
**\*DEFINE\_SPOTWELD\_FAILURE\_RESULTANTS**  
**\*DEFINE\_SPOTWELD\_RUPTURE\_PARAMETER**  
**\*DEFINE\_SPOTWELD\_RUPTURE\_STRESS**  
**\*DEFINE\_STAGED\_CONSTRUCTION\_PART**  
**\*DEFINE\_TABLE**  
**\*DEFINE\_TABLE\_2D**  
**\*DEFINE\_TABLE\_3D**  
**\*DEFINE\_TRANSFORMATION**  
**\*DEFINE\_VECTOR**

An additional option **\_TITLE** may be appended to all the **\*DEFINE** keywords. If this option is used then an addition line is read for each section in 80a format which can be used to describe the defined curve, table, etc. At present LS-DYNA does make use of the title. Inclusion of titles gives greater clarity to input decks.

Examples for the **\*DEFINE** keyword can be found at the end of this section.

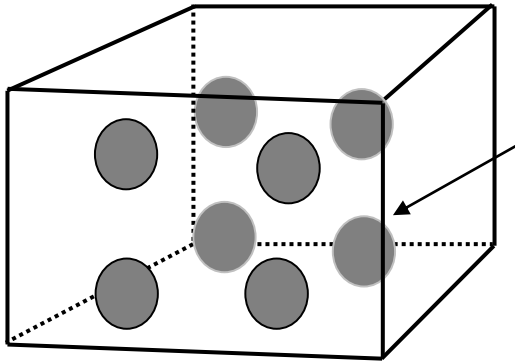


<u>VARIABLE</u>	<u>DESCRIPTION</u>
ITYPE	IPID type: EQ.0: Part ID, NE.0: Part set ID.
NQ	Adaptive option for hexahedral elements. For tetrahedral and pentahedral elements, see remark 1: EQ. 1: Adapt one solid element to one SPH element, EQ. 2: Adapt one solid element to 8 SPH elements, EQ. 3: Adapt one solid element to 27 SPH elements.
IPSPH	Part ID for newly generated SPH elements, See Remark 2.
ISSPH	Section ID for SPH elements, See Remark 2.
ICPL	Coupling of newly generated SPH elements to the adjacent solid elements: EQ. 0: Failure without coupling (debris simulation), EQ. 1: Coupled to Solid element.
IOPT	Coupling method (for ICPL=1 only See Remark 3): EQ. 0: Coupling from beginning (used as constraint between SPH elements and Solid elements), EQ. 1: Coupling begins when Lagrange element fails.

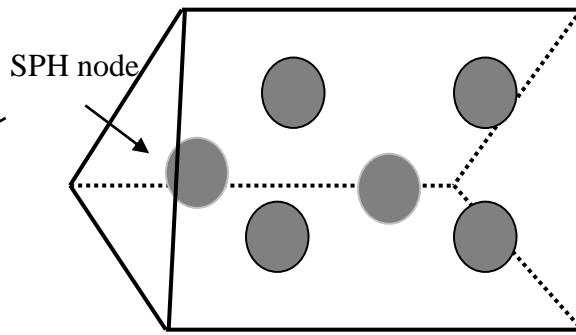
**Remarks:**

1. The SPH particles are evenly distributed within the solid element. For hexahedral elements the number of the generated SPH particles is  $NQ*NQ*NQ$ . For pentahedral elements, the number of generated SPH particles is 1, 6, and 18 for  $NQ=1, 2,$  and 3 respectively. For tetrahedral elements, the number generated SPH particles is 1, 4, and 10 for  $NQ=1, 2,$  and 3 respectively.
2. The Part ID for newly generated SPH particles can be either a new Part ID or the ID of an existing SPH Part. For constrain coupling (i.e.  $ICPL=1$  and  $IOPT=0$ ), the newly generated SPH part ID should be different from the existing one.
3.  $ICPL=0$  is used for debris simulation, no coupling happens between newly generated SPH particles and solid elements, user need to define node to surface contact for the interaction between those two parts. When  $ICPL=1$  and  $IOPT=1$ , the newly generated SPH particles are bonded with solid elements as one part through the coupling.

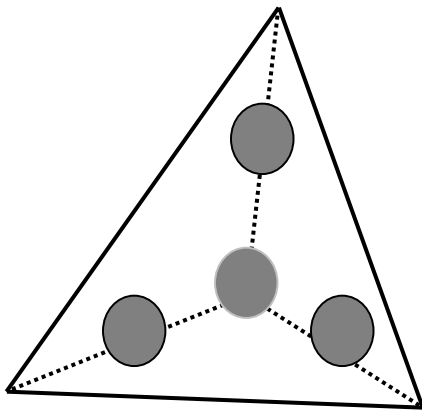




Example of SPH nodes for hexahedron element with  $NQ=2$



Example of SPH nodes for pentahedron element with  $NQ=2$



Example of SPH nodes for a tetrahedron element with  $NQ=2$

# \*DEFINE

## \*DEFINE\_ALEBAG\_BAG

### \*DEFINE\_ALEBAG\_BAG

Purpose: This card defines information about the Lagrangian airbag structure that is required as complementary definition to the \*AIRBAG\_ADVANCED\_ALE (AAA) card. It contains information about (a) one Lagrangian shell structure representing an airbag (or part of one), (b) venting characteristics of this airbag, and (c) its main coupling control features (Remark 1). The AAA card is used to model the airbag-to-inflator-gas interaction via the ALE method (Remark 2).

Card 1            1            2            3            4            5            6            7            8

Variable	BAGID	SID	SIDTYPE	CVBAG	IBLOCK	VTCOEF	VENTSID	VENTYP
Type	I	I	I	I	I	F	I	I
Default	none	none	1	none	none	none	0	none
Remarks	1			3	4	5	6	

**Card 2 (All coupling parameters are also defined similarly under the \*CONSTRAINED\_LAGRANGE\_IN\_SOLID card)**

Card 2            1            2            3            4            5            6            7            8

Variable	NQUAD	CTYPE	PFAC	FRIC	FRCMIN	NORMTY P	ILEAK	PLEAK
Type	I	I	F	F	F	I	I	F
Default	none	none	0.1	none	none	2	0.1	none
Remarks	7		8				9	

**Card 3 Format (All coupling parameters are also defined similarly under the \*CONSTRAINED\_LAGRANGE\_IN\_SOLID card)**

Card 3            1            2            3            4            5            6            7            8

Variable	NORM	START	END					
Type	I	F	F					
Default	1	0.0	1.0E10					
Remarks	10							

<u>VARIABLE</u>	<u>DESCRIPTION</u>
BAGID	An ID associated with the airbag mesh definition defined to be used in a corresponding *AIRBAG_ADVANCED_ALE card (See Remark 1).
SID	A set ID defining the Lagrangian airbag structure that is to be coupled to the inflator gas in a corresponding *AIRBAG_ADVANCED_ALE card. BAGID points to SID.
SIDTYP	Set type for the SID above: EQ.0: for a part set ID (PSID) EQ.1: for a part ID (PID)
CVBAG	Flag for including the SID above in the control volume (CV) analysis phase (See Remark 3): EQ.0: Do not include the above SID in subsequent CV analysis EQ.1: Include the above SID in subsequent CV analysis
IBLOCK	Flag for considering contact blockage for venting holes and porous flow (See Remark 4): EQ.0: Do not consider contact blockage EQ.1: Consider contact blockage
VTCOEF	Flow coefficient for each vent surface area defined by VENTSID (See Remark 5).
VENTSID	Set ID defining the vent hole surface (shape, See Remark 6). This venting estimate is sometimes referred to as “isentropic venting” as the flow is estimated via isentropic flow correlations. The amount of mass that escapes out of the vent hole is simply subtracted (deleted) from the mass inside the airbag, reducing the inflating potential of the inflator gas. The vented flow AMMG cannot be visualized in LS-PrePost.

<b>VARIABLE</b>	<b>DESCRIPTION</b>
VENTYP	Set ID type of the vent surface area defined by VENTSID: EQ.0: Part set ID (PSID). EQ.1: Part ID (PID). EQ.2: Segment set ID (SGSID).
NQUAD	Number of (quadrature) coupling points distributed over each coupled Lagrangian surface segment (See Remark 7). EQ.0: NQUAD will be set by default to 4, EQ.n: An NQUAD*NQUAD coupling points distribution over each Lagrangian segment is defined, EQ.-n: NQUAD is reset to a positive value. Coupling at nodes is obsolete.
CTYPE	Fluid-Structure coupling method: EQ.4: penalty coupling for shell (with or without erosion) and solid elements (without erosion). DIREC is set to 2 (default). EQ.6: penalty coupling designed for airbag modeling which automatically controls the DIREC parameter internally. It is equivalent to setting {CTYPE=4; DIREC=1} for unfolded region; and {CTYPE=4; DIREC=2}; in folded region. For both cases: {ILEAK=2; FRCMIN=0.3}.
PFAC	Penalty factor (CTYPE 4 and 6). PFAC is a scale factor for scaling the estimated stiffness of the interacting (coupling) system. It is used to compute the coupling forces to be distributed on the slave and master parts. If positive real: Fraction of estimated critical stiffness. If negative integer, -n: Refers to load curve ID n. The curve defines the coupling pressure (y-axis) as a function of the penetration (x-axis). (See Remark 8).
FRIC	Coefficient of friction (used with DIREC 2 only).
FRCMIN	Minimum volume fraction of a coupled ALE multi-material group (AMMG), or fluid, in a multi-material ALE element to activate coupling. Default value is 0.5. Reducing FRCMIN (typically, between 0.1 and 0.3) would turn on coupling earlier to prevent leakage in hypervelocity impact cases.
NORMTYP	Penalty coupling spring (or force) direction (DIREC 1 and 2): EQ.0: normal vectors are interpolated from nodal normals (default). EQ.1: normal vectors are interpolated from segment normals. This is sometimes a little more robust for sharp Lagrangian corners, and folds.

---

<u>VARIABLE</u>	<u>DESCRIPTION</u>
ILEAK	Coupling leakage control flag (See Remark 9): EQ.0: none (default), EQ.1: weak, leakage control is turned off if the penetrating volfrac > FRCMIN+0.1. EQ.2: strong, with improved energy consideration. Leakage control is turned off if the penetrating volfrac > FRCMIN+0.3.
PLEAK	Leakage control penalty factor, $0 < \text{PLEAK} < 0.2$ . This factor influences the additional coupling force magnitude to prevent leakage. It is conceptually similar to PFAC. Most of the time, the default value (0.1) is adequate.
NORM	A flag indicating the rule for defining which side of the Lagrangian segment the fluid is supposed to be coupled to. By default (NORM=0) the fluid on the side pointed to by the Lagrangian segment normal (head-side) is coupled to. To couple to the fluid on the side not pointed to by the segment normals (tail-side), set NORM=1 (See Remark 10). “Head” and “tail” refer to the normal vector of the coupling segment. EQ.0: Couple fluid to head-side of Lagrangian segment. EQ.1: Couple fluid to tail-side of Lagrangian segment.
START	Start time for coupling.
END	End time for coupling.

**Remarks:**

1. This command provides supplemental information for the main \*AIRBAG\_ADVANCED\_ALE (AAA) card. Specifically, it defines (a) a Lagrangian airbag structure that couples with the inflator gas, (b) its venting characteristics, and (c) some of the main coupling parameters. The information input for the AAA set is translated into the ALE keywords internally in LS-DYNA. This input approach does not include all the control features available in the regular ALE modeling approach, especially for couplings. Therefore highly complex fluid-structure interactions may require going back to the traditional ALE input approach. For more details on all coupling parameters, please see \*CONSTRAINED\_LAGRANGE\_IN\_SOLID card.
2. The airbag inflation process may be modeled in 2 stages. In the 1<sup>st</sup> stage the bag-gas interaction is modeled via ALE method where a variable pressure field inside the airbag may be simulated. In the 2<sup>nd</sup> stage, after the airbag has opened up sufficiently, the uniform pressure inflation method (also called control volume, or CV, approach) is used to inflate the bag. Please refer to the AAA card for more information.
3. If the Lagrangian structure is to be included in the 1<sup>st</sup> stage only (deployment using ALE method) but to be excluded from the 2<sup>nd</sup> stage analysis (uniform pressure analysis), then

set CVBAG=0. One such example may be the inner bag of a bag-in-bag model. If the defined Lagrangian structure is to be included in both computational phases, set CVBAG=1.

4. Fabric venting and porous flow behaviors for ALE and CV phases (see \*CONSTRAINED\_LAGRANGIAN\_IN\_SOLID (CLIS) and \*AIRBAG\_HYBRID) is defined under the \*MAT\_FABRIC card {FLC(t), FAC(P), FVOPT}. The FLC(t) is the orifice flow coefficient (typically is close to 1.0). FAC(P) is a relative porous gas speed curve as a function of absolute upstream pressure. For AAA application, FVOPT must be either 7 or 8. FVOPT 7 and 8 will be used for both ALE and CV phases (\*AIRBAG\_HYBRID). Blockage consideration for both venting and porous flows is accounted for by the IBLOCK flag. If IBLOCK=0 then in the CV phase FVOPT is set to 7, no contact blockage consideration. If IBLOCK=1 then in the CV phase FVOPT is set to 8, with contact blockage consideration. IBLOCK overwrites FVOPT.
5. VTCOEF will be used to scale the vent area for ALE venting. Upon switching to the CV phase, this coefficient will be used in place of the vent coefficient "C23" of the \*AIRBAG\_HYBRID card.
6. VENTSID defines the isentropic venting area definition which is used for ALE venting. Upon switching to the CV phase, the venting area will be used for venting in place of parameter "A23" of the \*AIRBAG\_HYBRID card.
7. See remark 2 under \*CONSTRAINED\_LAGRANGIAN\_IN\_SOLID.
8. See remark 6 under \*CONSTRAINED\_LAGRANGIAN\_IN\_SOLID
9. See remark 10 under \*CONSTRAINED\_LAGRANGIAN\_IN\_SOLID.
10. See remark 7 under \*CONSTRAINED\_LAGRANGIAN\_IN\_SOLID. Typically, if the airbag shell elements have their normal vectors pointing outward. Then to couple to the inflator gas from the inside of the bag NORM is set to 1 (the default value for NORM in this card).

**\*DEFINE\_ALEBAG\_HOLE**

Purpose: This optional card defines information about a physical vent hole structure of a Lagrangian airbag. This card is only used with an associated \*AIRBAG\_ADVANCED\_ALE (AAA) card to provide supplemental venting flow information for an airbag deployment simulation (Remark 1). This card defines (a) geometry of a vent hole, (b) information for switching the ALE multi-material group (AMMG) ID of the inflator gas when it passes through a vent hole, and (c) type of vent hole. The information input here is translated into a \*ALE\_FSI\_SWITCH\_MMG\_ID card (Remark 2).

Card                    1                    2                    3                    4                    5                    6                    7                    8

Variable	HOLEID	SID	SIDTYPE	NQUAD	XOFF	NFOLD	XCLLEN	
Type	I	I	I	I	F	I	F	
Default	none	none	none	none	none	none	none	
Remarks	1						3	

<u>VARIABLE</u>	<u>DESCRIPTION</u>
HOLEID	An ID associated with a vent hole surface in an airbag structure definition. It is defined to be used in a corresponding *AIRBAG_ADVANCED_ALE card. (See Remark 1.)
SID	A set ID defining the physical geometry a vent hole in the Lagrangian airbag structure. The inflator gas is supposed to pass through this hole.
SIDTYP	Set type for the SID above: EQ.0: for a part set ID (PSID) EQ.1: for a part ID (PID)
NQUAD	The number of flow-sensor points to be distributed over each monitoring surface or segment (defined by SID). There should be enough sensor points, distributed in each ALE element, to monitor the flow across this monitoring surface (see remark 3). At least 1 or 2 sensor points are needed in each ALE element to monitor the flow through that element. An alternate method for defining flow-sensor points is by defining XCLLEN parameter below.

---

<u>VARIABLE</u>	<u>DESCRIPTION</u>
XOFF	An offset distance away from the monitoring surface, beyond which the AMMGID switching occurs. A positive value of XOFF means the offset distance is along the normal vector direction of the monitoring segment, and vice versa. This offset distance, in general, should be about 1.5 to 2 times the ALE element widths where the vent flow is occurring (default=0.0).
NFOLD	Flag for checking folding logic (default=0=off). If NFOLD=1=on, then LS-DYNA will check if the shell elements defining the monitoring surface are in the folded region or not. If the monitoring segment is still located within a folded region, then no AMMG switching is allowed yet until it has unfolded.
XCLEN	This is an absolute distance for distributing the flow sensor points over each monitoring segment (surface). To make sure that at least 1 or 2 sensor points are present in each ALE element to track the flow of an AMMG, XCLEN may be roughly estimated as a third or one-half the width of the smallest ALE element in the mesh (see Remark 3).

**Remarks:**

1. A vent hole associated with an airbag structure may be defined for modeling physical venting (actual flow of material across the hole surface may be monitored, in contrast to isentropic venting where vented material is simply deleted). The primary function of this card is to define the vent hole geometry and the AMMG switching as the gas passes through it.

This card provides supplemental information for an associated \*AIRBAG\_ADVANCED\_ALE (AAA) card. The vent hole structure is associated with and airbag ID under AAA so that the coupling and AMMGID switching may be performed. This is equivalent to modeling “physical venting holes” via the \*CONSTRAINED\_LAGRANGE\_IN\_SOLID card. It is used only when users define fine enough ALE mesh to resolve the flow across the vent (physical venting, see remark 12 under \*CONSTRAINED\_LAGRANGE\_IN\_SOLID card).

The information input for the AAA card and all its supplemental commands are converted into the ALE keywords internally in LS-DYNA. The corresponding ALE keywords are written out to a file called “advalebak.kw” for checking. For an in-depth understanding of the interaction modeling, it is recommended that the users understand how to set up the coupling with the traditional ALE method.

2. For more detailed information, the user may review the \*ALE\_FSI\_SWITCH\_MMG\_ID card since it is the actions of this card that are being executed. The AMMGIDs of the gases involved in the switching, upstream and downstream of the hole are defined automatically.



3. When both NQUAD and XCLEN are defined, whichever gives smaller distance between sensor-points will be used. XCLEN may give better control as in the case of a null shell acting as the monitoring surface. As this null shell is stretched, NQUAD distribution of sensor-points may not be adequate, but XCLEN would be.

# \*DEFINE

## \*DEFINE\_ALEBAG\_INFLATOR

### \*DEFINE\_ALEBAG\_INFLATOR

Purpose: This card defines supplemental information about an airbag inflator that is required as complementary definition to the \*AIRBAG\_ADVANCED\_ALE (AAA) card. It defines the (a) orifices, (b) gas properties, and (c) inlet conditions (Remark 1). This command is only used with an associated \*AIRBAG\_ADVANCED\_ALE card. This card contains basic information that is required by the ALE command \*SECTION\_POINT\_SOURCE\_MIXTURES. It is only used for modeling airbag deployment process (Remark 2) via the ALE method.

Card 1            1            2            3            4            5            6            7            8

Variable	INFLAID	unused	unused	unused	NGAS	NORIF	LCIDVEL	LCIDT
Type	I				I	I	I	I
Default	none				none	none	0	none
Remarks	1							

### See \*AIRBAG\_HYBRID

Repeat this card "NGAS" times, one for each species in the mixture.

Card 2            1            2            3            4            5            6            7            8

Variable	LCIDMD	unused	unused	MWGAS	unused	A	B	C
Type	I			F		F	F	F
Default	none			none		none	0.0	0.0
Remarks						3	3	3

Repeat this card "NORIF" times. See \*SECTION\_POINT\_SOURCE\_MIXTURE

Card 3            1            2            3            4            5            6            7            8

Variable	NODEID	VECID	ORIFAREA	unused	unused	unused	unused	unused
Type	I	I	F					
Default	0	0	0.0					
Remarks	4							

<u>VARIABLE</u>	<u>DESCRIPTION</u>
INFLAID	An inflator ID. It is defined to be used in a corresponding *AIRBAG_ADVANCED_ALE card. (See Remark 1).
NGAS	Number of thermally equilibrated ideal gas species making up one inflator gas mixture.
NORIF	Number of inflator inlet orifices through which the inflator gas mixture is injected into the airbag. Each orifice requires a node ID to define its location (see NODEID below).
LCIDVEL	User-estimated inflator gas mixture average velocity load curve ID. If LCIDVEL=0 or blank, LSDYNA will estimate the inlet gas velocity.
LCIDT	Inflator gas mixture thermally equilibrated stagnation temperature load curve ID. All species of the mixture are assumed to have the same average stagnation temperature.
LCIDMD	The inlet mass flow rate load curve ID of this species of the inflator gas mixture.
MWGAS	Molecular weight of this species (e.g., kg/mole).
A	Nominal constant-pressure heat capacity (per-mole unit) at STP (see Remark 3).
B	1 <sup>st</sup> order (linear) coefficient of temperature dependent heat capacity of the inflator gas. (see Remark 3).
C	2 <sup>nd</sup> order (quadratic) coefficient of temperature dependent heat capacity of the inflator gas. (see Remark 3).

<b>VARIABLE</b>	<b>DESCRIPTION</b>
NODEID	A node ID defining the location of a point source (see Remark 4).
VECID	A vector ID defining the direction of flow at each point source.
ORIFAREA	The orifice area at each point source.

**Remarks:**

1. This card defines the inflator inflow information for one inflator referred to by an \*AIRBAG\_ADVANCED\_ALE (AAA) card. The basic information includes (a) gas properties, (b) orifices, and (c) inlet conditions. The gas properties are defined similarly to that of the \*AIRBAG\_HYBRID card. The orifices, and inlet conditions (see \*SECTION\_POINT\_SOURCE\_MIXTURE), consist of  $\dot{m}(t)$ ,  $T_{stag}(t)$ , and maybe an estimated inlet gas velocity curve,  $\tilde{v}_{gas}(t)$ , if available. The information input for the AAA card and all its associates are translated into ALE keywords internally in LS-DYNA. The ALE keywords translated by AAA are output to the “advalebak.kw” file for review. For in depth understanding of the interaction modeling, it is recommended that the users understand how to set up the coupling with the traditional ALE method. The AAA card requires 2 additional cards for complementary definitions, \*DEFINE\_ALEBAG\_BAG and \*DEFINE\_ALEBAG\_INFLATOR. One optional card, \*DEFINE\_ALEBAG\_HOLE, may be used to define the vent hole of the airbag.
2. The airbag inflation process may be modeled in 2 stages. In the 1<sup>st</sup> stage the bag-gas interaction is modeled via ALE method where a variable pressure field inside the airbag may be simulated. In the 2<sup>nd</sup> stage, after the airbag has opened up sufficiently, the uniform pressure inflation method (also called control volume, or CV, approach) is used to inflate the bag.
3. The per-mass-unit, temperature-dependent, constant-pressure heat capacity is

$$C_p(T) = \frac{[A + B * T + C * T^2]}{MW} \sim \frac{J}{kg * K} \quad \begin{matrix} B \sim J / (\text{mole} * K^2) \\ C \sim J / (\text{mole} * K^3) \end{matrix}$$

$$A = \tilde{C}_{p0} \sim J / (\text{mole} * K)$$

The units shown are only for demonstration of the equation. Please see the \*MAT\_GAS\_MIXTURE card definition.

4. In general, it is best to locate a point source near the center of an ALE element. Associated with each point source is an area and a vector indicating flow direction. Each point source should occupy 1 ALE element by itself, and there should be at least 2 empty ALE elements between any 2 point-sources. A point source should be located at least 2 or 3 elements away from the free surface of an ALE mesh or a Lagrangian

surface to prevent interaction with the mesh boundary or coupling boundary (see \*SECTION\_POINT\_SOURCE\_MIXTURE).

**\*DEFINE\_BOX\_{OPTION}**

Available options include:

**<BLANK>**

**LOCAL**

Purpose: Define a box-shaped volume. Two diagonally opposite corner points of a box are specified in global or local coordinates if the LOCAL option is active. The box volume is then used for various specifications for a variety of input options, e.g., velocities, contact, etc.

If the option, LOCAL, is active, a local coordinate system with two vectors, see Figure 13.1, is defined. The vector cross product,  $z = x \times xy$ , determines the local z-axis. The local y-axis is then given by  $y = z \times x$ . A point, X in the global coordinate system is considered to lie with the volume of the box if the coordinate X-C, where C is the global coordinate offset vector defined on Card 3, lies within the box after transformation into the local system,  $XC\_local=T*(X-C)$ . The local coordinate, XC\_local, is checked against the minimum and maximum coordinates defined on Card 1 in the local system. For the \*INCLUDE\_TRANSFORM options that include translations and rotations, all box options are automatically converted from \*DEFINE\_BOX\_xxxx to \*DEFINE\_BOX\_xxxx\_LOCAL in the DYNA.INC file. Here, xxxx represents the box options: ADAPTIVE, COARSEN, and SPH, which are defined below.

Card            1            2            3            4            5            6            7            8

Variable	BOXID	XMN	XXM	YMN	YMX	ZMN	ZMX	
Type	I	F	F	F	F	F	F	
Default	0	0.0	0.0	0.0	0.0	0.0	0.0	

**Define the following 2 cards if option LOCAL is specified.**

Card 2            1            2            3            4            5            6            7            8

Variable	XX	YX	ZX	XV	YV	ZV		
Type	F	F	F	F	F	F		
Default	0.0	0.0	0.0	0.0	0.0	0.0		

Card 3            1            2            3            4            5            6            7            8

Variable	CX	CY	CZ					
Type	F	F	F					
Default	0.0	0.0	0.0					

**VARIABLE****DESCRIPTION**

BOXID	Box ID. Define unique numbers.
XMN	Minimum x-coordinate. Define in the local coordinate system if the option LOCAL is active.
XXM	Maximum x-coordinate. . Define in the local coordinate system if the option LOCAL is active.
YMN	Minimum y-coordinate. . Define in the local coordinate system if the option LOCAL is active.
YXM	Maximum y-coordinate. . Define in the local coordinate system if the option LOCAL is active.
ZMN	Minimum z-coordinate. . Define in the local coordinate system if the option LOCAL is active.
ZXM	Maximum z-coordinate. . Define in the local coordinate system if the option LOCAL is active.
XX	X-coordinate on local x-axis. Origin lies at (0,0,0). Define if the LOCAL option is active.
YX	Y-coordinate on local x-axis. Define if the LOCAL option is active.
ZX	Z-coordinate on local x-axis. Define if the LOCAL option is active.
XV	X-coordinate of local x-y vector. Define if the LOCAL option is active.
YV	Y-coordinate of local x-y vector. Define if the LOCAL option is active.
ZV	Z-coordinate of local x-y vector. Define if the LOCAL option is active.

<u>VARIABLE</u>	<u>DESCRIPTION</u>
CX	X-global coordinate of offset vector to origin of local system. Define if the LOCAL option is active.
CY	Y-global coordinate of offset vector to origin of local system. Define if the LOCAL option is active.
CZ	Z-global coordinate of offset vector to origin of local system. Define if the LOCAL option is active.



**\*DEFINE\_BOX\_ADAPTIVE\_{OPTION}**

Available options include:

**<BLANK>**

**LOCAL**

Purpose: Define a box-shaped volume enclosing the elements where the adaptive level is to be specified. If the midpoint of the element falls within the box the adaptive level is reset. Elements falling outside of this volume use the value, MAXLVL, on the \*CONTROL\_ADAPTIVE control cards.

Card 1            1            2            3            4            5            6            7            8

Variable	BOXID	XMN	XMN	YMN	YMX	ZMN	ZMX	
Type	I	F	F	F	F	F	F	
Default	none	0.0	0.0	0.0	0.0	0.0	0.0	

Card 2            1            2            3            4            5            6            7            8

Variable	PID	LEVEL						
Type	I	I						
Default	0	none						

# \*DEFINE

# \*DEFINE\_BOX\_ADAPTIVE

Define the following 2 cards if option LOCAL is specified. See \*DEFINE\_BOX for a description of the LOCAL option.

Card 3            1            2            3            4            5            6            7            8

Variable	XX	YX	ZX	XV	YV	ZV		
Type	F	F	F	F	F	F		
Default	0.0	0.0	0.0	0.0	0.0	0.0		

Card 4            1            2            3            4            5            6            7            8

Variable	CX	CY	CZ					
Type	F	F	F					
Default	0.0	0.0	0.0					

<u>VARIABLE</u>	<u>DESCRIPTION</u>
BOXID	Box ID. Define unique numbers.
XMN	Minimum x-coordinate. Define in the local coordinate system if the option LOCAL is active.
XXM	Maximum x-coordinate. . Define in the local coordinate system if the option LOCAL is active.
YMN	Minimum y-coordinate. . Define in the local coordinate system if the option LOCAL is active.
YYM	Maximum y-coordinate. . Define in the local coordinate system if the option LOCAL is active.
ZMN	Minimum z-coordinate. . Define in the local coordinate system if the option LOCAL is active.
ZZM	Maximum z-coordinate. . Define in the local coordinate system if the option LOCAL is active.

---

<b>VARIABLE</b>	<b>DESCRIPTION</b>
PID	Part ID. If zero, all active elements within box are considered.
LEVEL	Maximum number of refinement levels for elements that are contained in the box. Values of 1, 2, 3, 4,... allow a maximum of 1, 4, 16, 64, ... elements, respectively, to be created for each original element.
XX	X-coordinate on local x-axis. Origin lies at (0,0,0). Define if the LOCAL option is active.
YX	Y-coordinate on local x-axis. Define if the LOCAL option is active.
ZX	Z-coordinate on local x-axis. Define if the LOCAL option is active.
XV	X-coordinate of local x-y vector. Define if the LOCAL option is active.
YV	Y-coordinate of local x-y vector. Define if the LOCAL option is active.
ZV	Z-coordinate of local x-y vector. Define if the LOCAL option is active.
CX	X-global coordinate of offset vector to origin of local system. Define if the LOCAL option is active.
CY	Y-global coordinate of offset vector to origin of local system. Define if the LOCAL option is active.
CZ	Z-global coordinate of offset vector to origin of local system. Define if the LOCAL option is active.

# \*DEFINE

# \*DEFINE\_BOX\_COARSEN

\*DEFINE\_BOX\_COARSEN\_{OPTION}

Available options include:

<BLANK>

**LOCAL**

Purpose: Define a specific box-shaped volume indicating elements which are protected from mesh coarsening. See also \*CONTROL\_COARSEN.

Card            1            2            3            4            5            6            7            8

Variable	BOXID	XMN	XXM	YMN	YMX	ZMN	ZMX	IFLAG
Type	I	F	F	F	F	F	F	I
Default	none	0.0	0.0	0.0	0.0	0.0	0.0	0

**Define the following 2 cards if option LOCAL is specified. See \*DEFINE\_BOX for a description of the LOCAL option.**

Card 2            1            2            3            4            5            6            7            8

Variable	XX	YX	ZX	XV	YV	ZV		
Type	F	F	F	F	F	F		
Default	0.0	0.0	0.0	0.0	0.0	0.0		

Card 3            1            2            3            4            5            6            7            8

Variable	CX	CY	CZ					
Type	F	F	F					
Default	0.0	0.0	0.0					

**VARIABLE****DESCRIPTION**

BOXID	Box ID. Define unique numbers.
XMN	Minimum x-coordinate. Define in the local coordinate system if the option LOCAL is active.
XXM	Maximum x-coordinate. . Define in the local coordinate system if the option LOCAL is active.
YMN	Minimum y-coordinate. . Define in the local coordinate system if the option LOCAL is active.
YMX	Maximum y-coordinate. . Define in the local coordinate system if the option LOCAL is active.
ZMN	Minimum z-coordinate. . Define in the local coordinate system if the option LOCAL is active.
ZMX	Maximum z-coordinate. . Define in the local coordinate system if the option LOCAL is active.
IFLAG	Flag for protecting elements inside or outside of box. EQ.0: elements inside the box cannot be coarsened EQ.1: elements outside the box cannot be coarsened
XX	X-coordinate on local x-axis. Origin lies at (0,0,0). Define if the LOCAL option is active.
YX	Y-coordinate on local x-axis. Define if the LOCAL option is active.
ZX	Z-coordinate on local x-axis. Define if the LOCAL option is active.
XV	X-coordinate of local x-y vector. Define if the LOCAL option is active.
YV	Y-coordinate of local x-y vector. Define if the LOCAL option is active.

<u>VARIABLE</u>	<u>DESCRIPTION</u>
ZV	Z-coordinate of local x-y vector. Define if the LOCAL option is active.
CX	X-global coordinate of offset vector to origin of local system. Define if the LOCAL option is active.
CY	Y-global coordinate of offset vector to origin of local system. Define if the LOCAL option is active.
CZ	Z-global coordinate of offset vector to origin of local system. Define if the LOCAL option is active.

**Remarks:**

1. Many boxes may be defined. If an element is protected by any box then it may not be coarsened.

**\*DEFINE\_BOX\_DRAWBEAD**

Purpose: Define a specific box or tube shaped volume around a draw bead. This option is useful for the draw bead contact. If box shaped, the volume will contain the draw bead nodes and elements between the bead and the outer edge of the blank. If tubular, the tube is centered around the draw bead. All elements within the tubular volume are included in the contact definition.

Card                    1                    2                    3                    4                    5                    6                    7                    8

Variable	BOXID	PID	SID	IDIR	STYPE	RADIUS	CID	
Type	I	F	F	F	I	F	I	
Default	0	0.0	0.0	0.0	4	0.0	0	
Remarks						optional	optional	

<u>VARIABLE</u>	<u>DESCRIPTION</u>
BOXID	Box ID. Define unique numbers.
PID	Part ID of blank.
SID	Set ID that defines the nodal points that lie along the draw bead. If a node set is defined, the nodes in the set must be consecutive along the draw bead. If a part or part set is defined, the set must consist of beam or truss elements. Within the part set, no ordering of the elements is assumed, but the number of nodes must equal the number of beam elements plus 1.
IDIR	Direction of tooling movement. The movement is in the global coordinate direction unless the tubular box option is active and CID is nonzero. In this latter case, the movement is in the local coordinate direction. EQ.1: tooling moves in x-direction, EQ.2: tooling moves in y-direction, EQ.3: tooling moves in z-direction.

<b>VARIABLE</b>	<b>DESCRIPTION</b>
STYPE	Set type: EQ.2: part set ID, EQ.3: part ID, EQ.4: node set ID.
RADIUS	The radius of the tube, which is centered around the draw bead. Elements of part ID, PID, that lie within the tube will be included in the contact. If the radius is not defined, a rectangular box is used instead. This option is recommended for curved draw beads and for draw beads that are not aligned with the global axes.
CID	Optional coordinate system ID. This option is only available for the tubular drawbead. This option is available starting in the third release of version 971.



**\*DEFINE\_BOX\_SPH\_{OPTION}**

Available options include:

**<BLANK>**

**LOCAL**

Purpose: Define a box-shaped volume. Two diagonally opposite corner points of a box are specified in global coordinates. Particle approximations of SPH elements are computed when particles are located inside the box. The load curve describes the motion of the maximum and minimum coordinates of the box.

Card 1            1            2            3            4            5            6            7            8

Variable	BOXID	XMN	XXM	YMN	YMX	ZMN	ZMX	VID
Type	I	F	F	F	F	F	F	I
Default	none	0.0	0.0	0.0	0.0	0.0	0.0	0

Card 2            1            2            3            4            5            6            7            8

Variable	LCID	VD	NID					
Type	I	I	I					
Default	0	0	0					

# \*DEFINE

# \*DEFINE\_BOX\_SPH

Define the following 2 cards if option LOCAL is specified. See \*DEFINE\_BOX for a description of the LOCAL option.

Card 3            1            2            3            4            5            6            7            8

Variable	XX	YX	ZX	XV	YV	ZV		
Type	F	F	F	F	F	F		
Default	0.0	0.0	0.0	0.0	0.0	0.0		

Card 4            1            2            3            4            5            6            7            8

Variable	CX	CY	CZ					
Type	F	F	F					
Default	0.0	0.0	0.0					

## VARIABLE

## DESCRIPTION

BOXID	Box ID. Define unique numbers.
XMN	Minimum x-coordinate. Define in the local coordinate system if the option LOCAL is active.
XMN	Maximum x-coordinate. Define in the local coordinate system if the option LOCAL is active.
YMN	Minimum y-coordinate. Define in the local coordinate system if the option LOCAL is active.
YMN	Maximum y-coordinate. Define in the local coordinate system if the option LOCAL is active.
ZMN	Minimum z-coordinate. Define in the local coordinate system if the option LOCAL is active.
ZMN	Maximum z-coordinate. Define in the local coordinate system if the option LOCAL is active.

---

<b>VARIABLE</b>	<b>DESCRIPTION</b>
VID	Vector ID for DOF, see *DEFINE_VECTOR.
LCID	Load curve ID to describe motion value versus time, see *DEFINE_CURVE
VD	Velocity/Displacement flag: EQ.0: velocity, EQ.1: displacement, EQ.2: referential node
NID	Referential nodal ID for VD=2 (SPH box will move with this node).
XX	X-coordinate on local x-axis. Origin lies at (0,0,0). Define if the LOCAL option is active.
YX	Y-coordinate on local x-axis. Define if the LOCAL option is active.
ZX	Z-coordinate on local x-axis. Define if the LOCAL option is active.
XV	X-coordinate of local x-y vector. Define if the LOCAL option is active.
YV	Y-coordinate of local x-y vector. Define if the LOCAL option is active.
ZV	Z-coordinate of local x-y vector. Define if the LOCAL option is active.
CX	X-global coordinate of offset vector to origin of local system. Define if the LOCAL option is active.
CY	Y-global coordinate of offset vector to origin of local system. Define if the LOCAL option is active.
CZ	Z-global coordinate of offset vector to origin of local system. Define if the LOCAL option is active.

# \*DEFINE

# \*DEFINE\_CONNECTION\_PROPERTIES

## \*DEFINE\_CONNECTION\_PROPERTIES\_{OPTION}

Available options include:

<BLANK>

### ADD

Purpose: Define failure related parameters for solid element spot weld failure by \*MAT\_SPOTWELD\_DAIMLERCHRYSLER. For each connection identifier, CON\_ID, a separate \*DEFINE\_CONNECTION\_PROPERTIES section must be included. The **ADD** option allows material specific properties to be added to an existing connection ID. See remark 2.

Card 1            1            2            3            4            5            6            7            8

Variable	CON_ID	PROPRU L	AREAEQ		DG_TYP			
Type	F	I	I		I			
Default	0	0	0		0	.		

Card 2            1            2            3            4            5            6            7            8

Variable		D_SIGY	D_ETAN	D_DG_PR	D_RANK	D_SN	D_SB	D_SS
Type		F	F	F	F	F	F	F
Default		none	none	1.0e+10	none	none	none	none

Card 3            1            2            3            4            5            6            7            8

Variable	D_EXSN	D_EXSB	D_EXSS	D_LCSN	D_LCSB	D_LCSS	D_GFAD	
Type	F	F	F	I	I	I	F	
Default	1.0	1.0	1.0	0	0	0	none	

**Define the following 2 cards for each shell material that will have material specific data defined for this CON\_ID. The input is terminated by the next “\*” keyword card.**

Card 4            1            2            3            4            5            6            7            8

Variable	MID	SGIY	ETAN	DG_PR	RANK	SN	SB	SS
Type	A8	F	F	F	F	F	F	F
Default				1.0e+10				

Card 5            1            2            3            4            5            6            7            8

Variable	EXSN	EXSB	EXSS	LCSN	LCSB	LCSS	GFAD	
Type	F	F	F	I	I	I	F	
Default								

<u>VARIABLE</u>	<u>DESCRIPTION</u>
CON_ID	Connection ID, referenced on *MAT_SPOTWELD_DAIMLERCHRYSLER. Multiple sets of connection data may be used by assigning different connection IDs.
PROPRUL	The failure rule number for this connection.

---

<b>VARIABLE</b>	<b>DESCRIPTION</b>
AREAEQ	Area equation number for the connection area calculation. EQ.0: (default) area_true=area_modeled EQ.1: millimeter form; see Remark 4 EQ.-1: meter form; see Remark 4
DG_TYP	Damage type EQ.0: no damage function is used EQ.1: strain based damage EQ.2: failure function based damage EQ.3 or 4: fading energy based damage; see Remark 4
D_SIGY	Default yield stress for the spot weld element.
D_ETAN	Default tangent modulus for the spot weld element.
D_DG_PR	Default damage parameter for hyperbolic based damage function.
D_RANK	Default rank value.
D_SN	Default normal strength.
D_SB	Default bending strength.
D_SS	Default shear strength.
D_EXSN	Default exponent on normal stress term.
D_EXSB	Default exponent on bending stress term.
D_EXSS	Default exponent on shear stress term.
D_LCSN	Default curve ID for normal strength scale factor as a function of strain rate.
D_LCSB	Default curve ID for bending strength scale factor as a function of strain rate.
D_LCSS	Default curve ID for shear strength scale factor as a function of strain rate.
D_GFAD	Default fading energy for damage type 3 and type 4.
MID	Material ID of the shell material for which properties are defined.
SIGY	Yield stress to be used in the spot weld element calculation.

---

<u>VARIABLE</u>	<u>DESCRIPTION</u>
ETAN	Tangent modulus to be used in the spot weld element calculation.
DG_PR	Damage parameter for hyperbolic based damage function.
RANK	Rank value. See Remark 4.
SN	Normal strength.
SB	Bending strength.
SS	Shear strength.
EXSN	Exponent on normal stress term.
EXSB	Exponent on bending stress term.
EXSS	Exponent on shear stress term.
LCSN	Curve ID for normal strength scale factor as a function of strain rate.
LCSB	Curve ID for bending strength scale factor as a function of strain rate.
LCSS	Curve ID for shear strength scale factor as a function of strain rate.
LCSS	Fading energy for damage type 3.

**Remarks:**

1. This keyword is used only with \*MAT\_SPOTWELD\_DAIMLERCHRYSLER. The data input is used in a 3 parameter failure model. Each solid spot weld element connects shell elements that may have the same or different materials. The failure model assumes that failure of the spot weld depends on the properties of the welded materials, so this keyword allows shell material specific data to be input for the connection. The default data will be used for any spot weld connected to a shell material that does not have material specific data defined, so it is not necessary to define material specific data for all welded shell materials.
2. To simplify data input, the ADD keyword option allows material specific data to be added to an existing \*DEFINE\_CONNECTION\_PROPERTIES table. To use the ADD option, omit cards 2 and 3, and input only CON\_ID on card 1. Then use cards 4 and 5 to input material specific data. For each unique CON\_ID, control parameters and default values must be input in one set of \*DEFINE\_CONNECTION\_PROPERTIES data. The same CON\_ID may be used for any number of sets of material specific data input with the ADD option.

3. The three parameter failure function is

$$f = \left( \frac{\sigma_n}{\sigma_n^F} \right)^{m_n} + \left( \frac{\sigma_b}{\sigma_b^F} \right)^{m_b} + \left( \frac{\tau}{\tau^F} \right)^{m_\tau} - 1$$

where the three strength terms are SN, SB, and SS, and the three exponents are EXSN, EXSB, and EXSS. The strengths may be a function of strain rate by using the load curves, LCSN, LCSB, and LCSS. The peak stresses in the numerators are calculated from force resultants and simple beam theory.

$$\sigma_n = \frac{N_{rr}}{A} \quad \sigma_b = \frac{\sqrt{M_{rs}^2 + M_{rt}^2}}{Z} \quad \tau = \frac{M_{rr}}{2Z} + \frac{\sqrt{N_{rs}^2 + N_{rt}^2}}{A}$$

where the area is the cross section area of the weld element and Z is given by:

$$Z = \pi \frac{d^3}{32}$$

where d is the equivalent diameter of the solid spot weld element assuming a circular cross section.

4. There are three control parameters that define how the table data will be used for the connection, PROPRUL, AREA\_EQ, and DG\_TYP. PROPRUL determines how the parameters will be used. Because each weld connects two shell surfaces, one weld can have two sets of failure data as well as two values for ETAN and SIGY. At present, a single rule is implemented and the data with the lower RANK will be used.

The second control parameter is AREA\_EQ which specifies a rule for calculating a true weld cross section area,  $A_{true}$  to be used in the failure function in place of the modeled solid element area, A. For AREA\_EQ=1,  $A_{true}$  is calculated by

$$A_{true} = \frac{\pi}{4} \left( 5 \sqrt{t_{min\_shell}} \right)^2$$

where  $t_{min\_shell}$  is the thickness of the welded shell surface that has the smaller thickness. For AREA\_EQ=-1,  $A_{true}$  is calculated by

$$A_{true} = \frac{\pi}{4} \left( \frac{5}{1000} \sqrt{1000 * t_{min\_shell}} \right)^2$$

The equation for AREA\_EQ=1 is valid only for a length unit of millimeters, and AREA\_EQ=-1 is valid only for a length unit of meters.



The third control parameter, DG\_TYP, chooses from two available damage types. For DG\_TYP=0, damage is turned off and the weld fails immediately when  $f \geq 0$ . For DG\_TYP>0, damage is initiated when  $f \geq 0$  and complete failure occurs when  $\omega \geq 1$ . For DG\_TYP=1, damage growth is a function of plastic strain:

$$\omega = \frac{\varepsilon_{eff}^p - \varepsilon_{failure}^p}{\varepsilon_{rupture}^p - \varepsilon_{failure}^p} \quad \text{if} \quad \varepsilon_{failure}^p \leq \varepsilon_{eff}^p \leq \varepsilon_{rupture}^p$$

where  $\varepsilon_{eff}^p$  is the effective plastic strain in the weld material. When the value of the failure function first exceeds zero, the plastic strain at failure  $\varepsilon_{failure}^p$  is set to the current plastic strain, and the rupture strain is offset from the plastic strain at failure by

$$\varepsilon_{rupture}^p = \varepsilon_{failure}^p + RS - EFAIL$$

where RS and EFAIL are the rupture strain and plastic strain at failure which are input on the \*MAT\_SPOTWELD\_DAIMLERCHRYSLER card. If failure occurs when the plastic strain is zero, the weld material yield stress is reduced to the current effective stress such that damage can progress.

For DG\_TYP=2, damage is a function of the failure function, f:

$$\omega = \frac{f}{f_{rupture}} \quad \text{if} \quad f \geq 0$$

where  $f_{rupture}$  is the value of the failure function at rupture which is defined by

$$f_{rupture} = RS - EFAIL$$

and RS and EFAIL are input on the \*MAT\_SPOTWELD\_DAIMLERCHRYSLER card.

Because the DG\_TYP=1 damage function is scaled by plastic strain, it will monotonically increase in time. The DG\_TYP=2 damage function is forced to be a monotonically increasing function in time by using the maximum of the current value and the maximum previous value. For both DG\_TYP=1 and DG\_TYP=2, the stress scale factor is then calculated by

$$\hat{\sigma} = \frac{DG\_PR(1-\omega)}{\omega \left( \frac{1}{2} + \sqrt{\frac{1}{4} + DG\_PR} \right) + DG\_PR} \sigma$$

This equation becomes nearly linear at the default value of DG\_PR which is 1.0e+10.

For DG\_TYP=3, damage is a function of total strain:

$$\omega = \frac{\Delta \varepsilon_n}{\Delta \varepsilon_{\text{fading}}}$$

where  $\Delta \varepsilon_n$  is the accumulated total strain increment between moment of damage initiation (failure) and current time step  $t_n$

$$\Delta \varepsilon_n = \Delta \varepsilon_{n-1} + \Delta t_n \sqrt{2/3 \dot{\boldsymbol{\varepsilon}}_n : \dot{\boldsymbol{\varepsilon}}_n} \quad , \quad \Delta \varepsilon \Big|_{t_{\text{failure}}} = 0$$

and  $\Delta \varepsilon_{\text{fading}}$  is the total strain increment for fading (reduction of stresses to zero)

$$\Delta \varepsilon_{\text{fading}} = \frac{2 \text{GFAD}}{\sigma_{\text{failure}}}$$

where GFAD is the fading energy from input and  $\sigma_{\text{failure}}$  is the effective stress at failure. The stress scale factor is then calculated by a linear equation

$$\hat{\sigma} = (1 - \omega) \sigma$$

where  $\sigma$  is the Cauchy stress tensor at failure and  $\omega$  is the actual damage value. Problems can occur, if the loading direction changes after the onset of failure, since during the damage process, the components of the stress tensor are kept constant and hence represent the stress state at failure.

Therefore DG\_TYP=4 should be used describing the damage behavior of the spotweld in a more realistic way. For DG\_TYP=4, damage is a function of the internal work done by the spotweld after failure, i. e.,

$$\hat{\sigma} = (1 - \omega) \sigma^{\text{ep}} \quad , \quad \omega = \frac{G_{\text{used}}}{2\text{GFAD}} \quad , \quad G_{\text{used}} = G_{\text{used}}^{n-1} + \det F_{ij} \sigma_{ij}^{\text{ep}} \Delta \varepsilon_{ij} \quad .$$

Therein,  $F_{ij}$  is the deformation gradient.  $\sigma^{\text{ep}}$  is a scaled Cauchy stress tensor based on the undamaged Cauchy stress tensor  $\sigma^{\text{wd}}$  and scaled in such a way that the same internal work is done in the current time step as in the time step before (equipotential):

$$\sigma^{\text{ep}} = \alpha \sigma^{\text{wd}} \quad , \quad \alpha = \frac{\sigma_{ij}^{n-1, \text{ep}} \Delta \varepsilon_{ij}}{\sigma_{ij}^{\text{wd}} \Delta \varepsilon_{ij}} \quad .$$

**\*DEFINE\_CONSTRUCTION\_STAGES**

Purpose: Define times and durations of construction stages.

Note: This keyword card will be available starting in release 3 of version 971.

Card	1	2	3	4	5	6	7	8
------	---	---	---	---	---	---	---	---

Variable	ISTAGE	ATS	ATE	ATR	RTS	RTE		
Type	I	F	F	F	F	F		
Default	none	0.0	0.0	none	=ATS	=ATE		

<u>VARIABLE</u>	<u>DESCRIPTION</u>
ISTAGE	Stage ID
ATS	Analysis time at start of stage
ATE	Analysis time at end of stage
ATR	Analysis time duration of ramp
RTS	Real time at start of stage
RTE	Real time at end of stage

**Remarks:**

See also \*CONTROL\_CONSTRUCTION\_STAGES and \*DEFINE\_STAGED\_CONSTRUCTION\_PART.

The first stage should start at time zero. There must be no gaps between stages, i.e. ATS for each stage must be the same as ATE for the previous stage.

The ramp time allows gravity loading and part stiffening/removal to be applied gradually during the first time period ATR of the construction stage.

The analysis always runs in “analysis time” – typically measured in seconds. The “real time” is used only as a number to appear on output plots and graphs, and is completely arbitrary. A dynain file is written at the end of each stage.

# \*DEFINE

# \*DEFINE\_CONTACT\_VOLUME

## \*DEFINE\_CONTACT\_VOLUME

Purpose: Define a rectangular, a cylindrical, or a spherical volume in a local coordinate system. Nodes and segments which belong to specified part ID's and lie inside of the defined volume are used in the treatment of contact.

Card 1            1            2            3            4            5            6            7            8

Variable	CVID	CID	TYPE	XC	YC	ZC		
Type	I	I	I	F	F	F		
Default	0	0	0	0.	0.	0.		

### For type=0, rectangular prism

Card 2            1            2            3            4            5            6            7            8

Variable	XMN	XXM	YMN	YMX	ZMN	ZMX		
Type	F	F	F	F	F	F		
Default	0.0	0.0	0.0	0.0	0.0	0.0		

### For type=1, cylindrical volume

Card 2            1            2            3            4            5            6            7            8

Variable	LENGTH	RINNER	ROUTER	D_ANGC				
Type	F	F	F	F				
Default	0.0	0.0	0.0	0.0				

**For type=3, spherical volume**

Card 2            1            2            3            4            5            6            7            8

Variable	RINNER	ROUTER	D_ANGS					
Type	F	F	F					
Default	0.0	0.0	0.0					

<u>VARIABLE</u>	<u>DESCRIPTION</u>
CVID	Contact volume ID
CID	Coordinate system ID. Required for rectangular and cylindrical volumes
TYPE	Volume type. Set to 0 for rectangular, 1 for cylindrical, and 2 for spherical.
XC	x-coordinate which defines the origin of coordinate system or the center of the sphere for type=3 referenced to the global coordinate system.
YC	y-coordinate which defines the origin of coordinate system or the center of the sphere for type=3 referenced to the global coordinate system.
ZC	z-coordinate which defines the origin of coordinate system or the center of the sphere for type=3 referenced to the global coordinate system.
XMN	Minimum x-coordinate in local coordinate system.
XXM	Maximum x-coordinate in local coordinate system.
YMN	Minimum y-coordinate in local coordinate system.
YMX	Maximum y-coordinate in local coordinate system.
ZMN	Minimum z-coordinate in local coordinate system.
ZMX	Maximum z-coordinate in local coordinate system.
LENGTH	Length of cylinder originating at (XC,YC,ZC) and revolving around the local x-axis.
RINNER	Inner radius of cylinder or sphere.

<u>VARIABLE</u>	<u>DESCRIPTION</u>
ROUTER	Outer radius of cylinder or sphere.
D_ANGC	If the included angle between the axis of the cylinder and the normal vector to the contact segment is less than this angle, the segment is deleted.
D_ANGS	If the included angle between a line draw from the center of the sphere to the centroid of the segment, and the normal vector to the contact segment is greater than this angle, the segment is deleted.

**\*DEFINE\_COORDINATE\_NODES**

Purpose: Define a local coordinate system with three node numbers. The local cartesian coordinate system is defined in the following steps. If the primary direction is along the x-axis, then the z-axis is computed from the cross product of  $x$  and  $\bar{y}$ , (see Figure 13.1),  $z = x \times \bar{y}$ , then the y-axis is computed via  $y = z \times x$ . A similar procedure applies if the local axis is along the y or z axes. The DIR option below applies to the third release of 971 and later versions.

Card            1            2            3            4            5            6            7            8

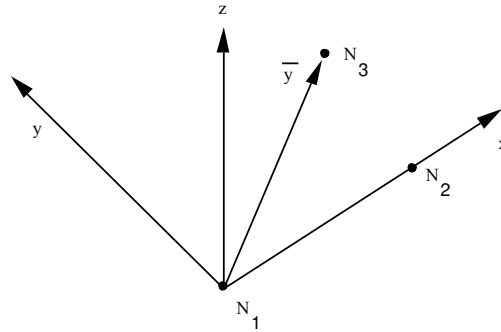
Variable	CID	N1	N2	N3	FLAG	DIR		
Type	I	I	I	I	I	A		
Default	0	0	0	0	0	X		

**VARIABLE****DESCRIPTION**

CID	Coordinate system ID. A unique number has to be defined.
N1	ID of node located at local origin.
N2	ID of node located along local x-axis if DIR=X, the y-axis if DIR=Y, and along the z axis if DIR=Z.
N3	ID of node located in local x-y plane if DIR=X, the local y-z plane if DIR=Y, and the local z-x plane if DIR=Z.
FLAG	Set to unity, 1, if the local system is to be updated each time step for the BOUNDARY_SPC nodal constraints and ELEMENT_BEAM type 6, the discrete beam element. Generally, this option when used with nodal SPC's is not recommended since it can cause excursions in the energy balance because the constraint forces at the node may go through a displacement if the node is partially constrained
DIR	Axis defined by node N2 moving from the origin node N1. The default direction is the x-axis.

**Remarks:**

1. The nodes N1, N2, and N3 must be separated by a reasonable distance and not colinear to avoid numerical inaccuracies.



**Figure 13.1.** Definition of local coordinate system using three nodes when the node N2 lies along the x-axis.



**\*DEFINE\_COORDINATE\_SYSTEM\_{OPTION}**

Available options include:

**<BLANK>**

**IGES**

Purpose: Define a local coordinate system.

When no option is used, the local coordinate system is defined by three points. The same procedure as described in Figure 13.1, see \*DEFINE\_COORDINATE\_NODES, is used. The coordinates of the nodes are given instead. N<sub>1</sub> is defined by (X<sub>0</sub>,Y<sub>0</sub>,Z<sub>0</sub>), N<sub>2</sub> is defined by (X<sub>L</sub>,Y<sub>L</sub>,Z<sub>L</sub>), and N<sub>3</sub> by (X<sub>P</sub>,Y<sub>P</sub>,Z<sub>P</sub>).

When option **IGES** is invoked, LS-DYNA will read the IGES file containing three straight curves each representing X, Y, Z axes, and create a local coordinate system according to what are described in Remarks.

**Card 1 of 2 – Required (for no option).**

Card 1            1            2            3            4            5            6            7            8

Variable	CID	XO	YO	ZO	XL	YL	ZL	CIDL
Type	I	F	F	F	F	F	F	I
Default	0	0.0	0.0	0.0	0.0	0.0	0.0	0

**Card 2 of 2 – Required (for no option).**

Card 2            1            2            3            4            5            6            7            8

Variable	XP	YP	ZP					
Type	F	F	F					
Default	0.0	0.0	0.0					

**Card 1 of 1 – Required for option \_IGES.**

Card 1            1            2            3            4            5            6            7            8

Variable	FILENAME
Type	C
Default	none

<u>VARIABLE</u>	<u>DESCRIPTION</u>
CID	Coordinate system ID. A unique number has to be defined.
XO	X-coordinate of origin.
YO	Y-coordinate of origin.
ZO	Z-coordinate of origin.
XL	X-coordinate of point on local x-axis.
YL	Y-coordinate of point on local x-axis.
ZL	Z-coordinate of point on local x-axis.
CIDL	Coordinate system ID applied to the coordinates used to define the current system. The coordinates XO, YO, ZO, XL, YL, ZL, XP, YP, and ZP are defined with respect to the coordinate system CIDL.
XP	X-coordinate of point in local x-y plane.
YP	Y-coordinate of point in local x-y plane.
ZP	Z-coordinate of point in local x-y plane.
FILENAME	Name of the IGES file containing three curves (see <b>Remarks</b> below).

**Remarks:**

1. The coordinates of the points must be separated by a reasonable distance and not colinear to avoid numerical inaccuracies.
2. Care must be taken to avoid chains of coordinate transformations because there is no guarantee that they will be executed in the correct order.

- 3. When option `_IGES` is used, three curves in the IGES format will be used to define a local coordinate system. IGES curve entity types 126, 110 and 106 are currently supported. Among the three curves, the longest length will be made as local Z-axis, the mid-length will be Y-axis and the shortest length X-axis. Suggested X, Y and Z-axis length is 100mm, 200mm and 300mm, respectively. All the three curves must have one identical point, and will be used for the origin of the new local coordinate system. Coordinate system ID of the local coordinate system will be based on the IGES file name input. The IGES file name must start with a number, followed by an “underscore” or a “dot”. The number preceding the file name will be used as the new local coordinate system ID, which can then be referenced in `*MAT_20` cards, for example.

After the LS-DYNA run, three beam elements of a new PID will be created in place of the three curves representing the local X, Y and Z-axis in the D3PLOT file for viewing in LS-PrePost.

The following is a partial input example of using the keyword to create a local coordinate system ID 25 from an IGES file named called “25\_iges”. The IGES file contains three curves in one of the three IGES entity types. The newly created coordinate system ID 25 will be used to define rigid body MID 2 of PID 2 to move in the local coordinate system, of which the local X degree of freedom is set free. In keyword `*BOUNDARY_PRESCRIBED_MOTION_RIGID`, option `_LOCAL` is used and the variable DOF is set to “1” to move the PID 2 according to local curves 3 and 5.

```

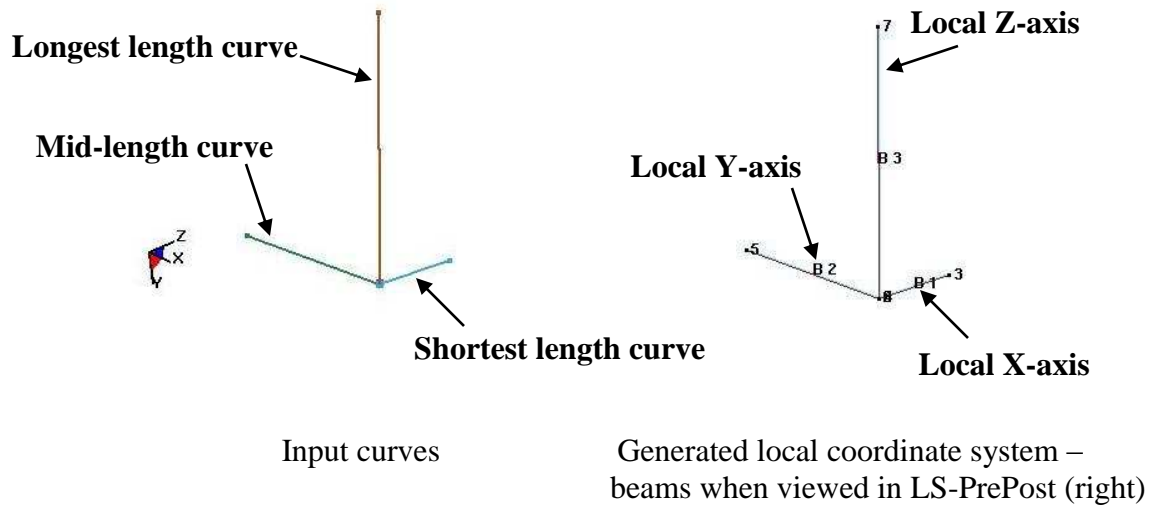
*KEYWORD
*DEFINE_COORDINATE_SYSTEM_IGES_TITLE
Flanging OP25
25_iges
$-----1-----2-----3-----4-----5-----6-----7-----8
*PART
punch
      2      2      2
*MAT_RIGID
$   MID      RO      E      PR      N      COUPLE      M      ALIAS
      2 7.830E-09 2.070E+05      0.28
$   CMO      CON1      CON2
      -1      25      011111
$LCO or A1      A2      A3      V1      V2      V3
25
$-----1-----2-----3-----4-----5-----6-----7-----8
*BOUNDARY_PRESCRIBED_MOTION_RIGID_LOCAL
$   typeID      DOF      VAD      LCID      SF      VID      DEATH      BIRTH
      2      1      0      3      -1.0      0      0.00241      0.0
      2      1      0      5      -1.0      0      0.0115243      0.00241

```

The keyword can be repeated for each new coordinate system if multiple coordinate systems are needed.

The following figure illustrates the corresponding axes.

This option is available in LS-DYNA R5 Revision 62798 and later releases.



(Courtesy of Daimler AG)

**\*DEFINE\_COORDINATE\_VECTOR**

Purpose: Define a local coordinate system with two vectors, see Figure 13.2. The vector cross product,  $z = x \times y$ , determines the z-axis. The y-axis is then given by  $y = z \times x$ . If this coordinate system is assigned to a nodal point, then at each time step during the calculation, the coordinate system is incrementally rotated using the angular velocity of the nodal point to which it is assigned.

Card                    1                    2                    3                    4                    5                    6                    7                    8

Variable	CID	XX	YX	ZX	XV	YV	ZV	NID
Type	I	F	F	F	F	F	F	I
Default	0	0.0	0.0	0.0	0.0	0.0	0.0	0.

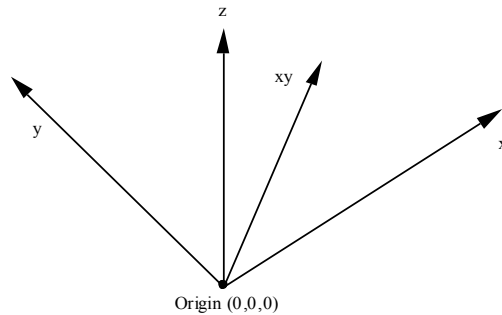
**VARIABLE****DESCRIPTION**

CID	Coordinate system ID. A unique number has to be defined.
XX	X-coordinate on local x-axis. Origin lies at (0,0,0).
YX	Y-coordinate on local x-axis
ZX	Z-coordinate on local x-axis
XV	X-coordinate of local x-y vector
YV	Y-coordinate of local x-y vector
ZV	Z-coordinate of local x-y vector
NID	Optional nodal point ID. The coordinate system rotates with the rotation of this node. If the node is not defined, the coordinate system is stationary.

**Remarks:**

1. These vectors should be separated by a reasonable included angle to avoid numerical inaccuracies.
2. Ideally, this nodal point should be attached to a rigid body or a structural part where the nodal point angular velocities are meaningful. It should be noted that angular velocities

of nodes may not be meaningful if the nodal point is attached only to solid elements and even to shell elements where the drilling degree of freedom may be singular, which is likely in flat geometries.



**Figure 13.2.** Definition of the coordinate system with two vectors.

**\*DEFINE\_CPM\_BAG\_INTERACTION**

Purpose: To allow interaction between two particle bags. The master bag should be an active particle bag and the slave bag is a control volume (CV) bag converted from a particle bag. The code will automatically search for all the common vent parts between these two bags for the interaction. The energy vented from the master bag will be recorded every time step as the energy input to the slave bag. This energy flow is applied in one direction only (master to slave). The slave bag pressure will be used as the downstream pressure for the master venting equation.

Card 1            1            2            3            4            5            6            7            8

Variable	Bag ID1	Bag ID2						
Type	I	I						
Default	none	none						

<u>VARIABLE</u>	<u>DESCRIPTION</u>
Bag ID1	Airbag ID of master CPM particle bag
Bag ID2	Airbag ID of slave CV bag switched from CPM bag

# \*DEFINE

# \*DEFINE\_CPM\_CHAMBER

## \*DEFINE\_CPM\_CHAMBER

Purpose: To define airbag chambers for air particle initialization or chamber interaction.

Card 1            1            2            3            4            5            6            7            8

Variable	ID	NCHM						
Type	I	I						
Default	none	0						

### Each chamber definition:

Card 2            1            2            3            4            5            6            7            8

Variable	SID1	SID2	NINTER	CHM_ID				
Type	I	I	I	I				
Default	none	0	0	0				

### Optional cards if NINTER>0(n=1...NINTER)

Card 3            1            2            3            4            5            6            7            8

Variable	SID3	ITYPE3	TOCHM					
Type	I	I	I					
Default	none	none	none					

### VARIABLE

### DESCRIPTION

ID

Unique ID for this card

NCHM

Number of chambers defined in this card

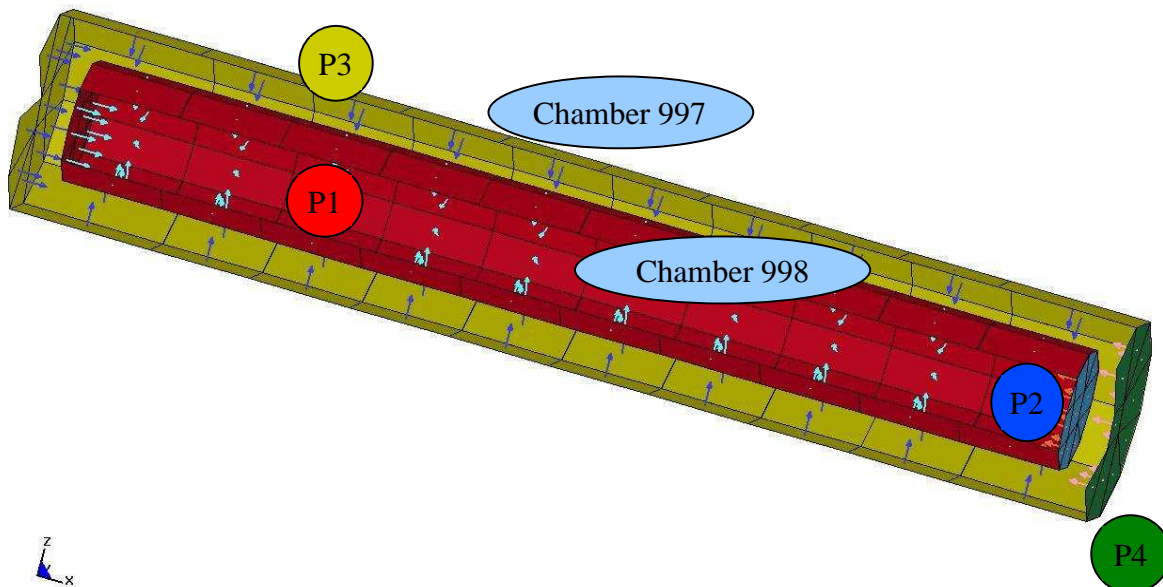


<u>VARIABLE</u>	<u>DESCRIPTION</u>
SID1	Part set defining the chamber (normals pointed inward; see Remark 1).
SID2	Part set defining the chamber (normals pointed outward; see Remark 1).
NINTER	Number of vent hole definition for chamber interaction.
CHM_ID	Chamber ID (see Remark 2).
SID3	Set defining interaction between chambers
ITYPE3	Set type EQ.0: Part EQ.1: Part set
TOCHM	The chamber ID of the connected chamber.

**Remarks**

1. Each chamber's volume is calculated based on part normal pointed inward. Parts with wrong orientation need to use the SID2 to invert the normal.

LS-DYNA keyword deck by LS-PrePost



```
*SET_PART_LIST
1
1      2      3      4
```

## **\*DEFINE**

## **\*DEFINE\_CPM\_CHAMBER**

```
*SET_PART_LIST
  20
  1      2
*DEFINE_CPM_CHAMBER
  1234      2
  20      0      1      998
  2      0      997
  1      20      1      997
  2      0      998
```

2. Particles with different chamber ID will not interact in particle to particle collision. This feature will allow program to distinguish particles separated by a thin wall.
3. All chambers data are output to lsda binout database. The utility "l2a" can convert it into abstat\_chamber ASCII file and process with lsprepost under abstat format

**\*DEFINE\_CPM\_GAS\_PROPERTIES**

Purpose: To define extended gas thermodynamic properties

Card 1            1            2            3            4            5            6            7            8

Variable	ID	Xmm	Cp0	Cp1	Cp2	Cp3	Cp4	
Type	I	F	F	F	F	F	F	
Default	none	none	none	none	none	none	none	

Card 1            1            2            3            4            5            6            7            8

Variable	$\mu_0$	$\mu_1$	$\mu_2$	$\mu_3$	$\mu_4$			
Type	F	F	F	F	F			
Default	none	none	none	none	none			

<u>VARIABLE</u>	<u>DESCRIPTION</u>
ID	Unique ID for this card
Xmm	Molar mass
Cp0..Cp4	Coefficients of temperature dependent specific heat with constant pressure  $C_p(T) = C_{p0} + C_{p1} T + C_{p2} T^2 + C_{p3} T^3 + C_{p4} T^4$
$\mu_0$ .. $\mu_4$	Coefficients of temperature dependent Joule-Thomson effect $\mu_t(T) = \mu_{t0} + \mu_{t1} T + \mu_{t2} T^2 + \mu_{t3} T^3 + \mu_{t4} T^4$

# \*DEFINE

# \*DEFINE\_CPM\_GAS\_PROPERTIES

\*AIRBAG\_PARTICLE

1010	1	1011	1	0	0.0	0.0	1
100000	0	1	300.0	1.0e-04	1		
1	1	1					
61	0	1.0	0	0	1	0.0	
1.0E-04	300.0	-9900					
651	653	-9910					
3000001	1.0						

\$=====

\*DEFINE\_CPM\_GAS\_PROPERTIES

9900	2.897E-02	2.671E+01	7.466E-03	-1.323E-06
9910	4.0E-03	20.79		
-610.63	-0.0926			

**\*DEFINE\_CPM\_VENT**

Purpose: To define extended vent hole options

Card 1            1            2            3            4            5            6            7            8

Variable	ID	C23	LCTC23	LCPC23	ENH_V	PPOP	C23UP	
Type	I	F	I	I	I	F	F	
Default	none	none	none	none	none	none	none	

Card 2            1            2            3            4            5            6            7            8

Variable	JT	IDS1	IDS2					
Type	I	I	I					
Default	0	none	none					

<u>VARIABLE</u>	<u>DESCRIPTION</u>
ID	Unique ID for this card
C23	Vent hole coefficient (Parameter for Wang-Nefske leakage) (Default 1.0)
LCTC23	Load curve defining vent hole coefficient as a function of time.
LCPC23	Load curve defining vent hole coefficient as a function of pressure.
ENH_V	Enhance venting option. (Default 0) However if Joule-Thomson effect is considered, the option will set to 1 automatically. EQ.0: disable EQ.1: enable
PPOP	Pressure difference between interior and ambient pressure to open the vent hole. Once the vent is open then it will stay open.

VARIABLE	DESCRIPTION
C23UP	Scale factor of C23 while switching from CPM to uniform pressure calculation
JT	Joule-Thomson effect, If Joule-Thomson effect is considered, ENH_V will set to enable. EQ.0: disable EQ.1: use part pressure EQ.2: use chamber pressure
IDS1	JT's up stream condition part ID/chamber ID
IDS2	JT's downstream condition part ID/chamber ID

\*AIRBAG\_PARTICLE

1010	1	1011	1	0	0.0	0.0	1
100000	0	1	300.0	1.0e-04	1		
1	1	1					
61	0	-9910					
1.0E-04	300.0	2.897E-02	2.671E+01	7.466E-03	-1.323E-06		
1000	1001	4.0E-03	20.79				
3000001	1.0						

\$=====

\*DEFINE\_CPM\_VENT

9910	1.0	0	0	1	0.0
1	51	2			

**\*DEFINE\_CURVE\_{OPTION}**

Purpose: Define a curve [for example, load (ordinate value) versus time (abscissa value)], often referred to as a load curve.

Curves are discretized internally with equal intervals along the abscissa for fast evaluation in constitutive models. Discretized curves are not used for evaluating loading conditions. Also, see remark 1 below. To improve the accuracy of the discretized curves in later releases of version 970 changes were made in the discretization process. These changes had the unexpected effect of changing the results generated with validated models such as barriers and occupants. Consequently, OPTION was added to make available the old discretization if needed for the validated models.

Available options include:

**<OPTION>**

**3858**

**5434a**

which correspond to the first releases of version 970 and the 2005 release, respectively.

Since input errors and wrong results are sometimes related to load curve usage, a “Load curve usage” table is printed in the D3HSP file after all the input is read. This table should be checked to insure that each curve ID is referenced by the option for which the curve is intended.

Card 1            1            2            3            4            5            6            7            8

Variable	LCID	SIDR	SFA	SFO	OFFA	OFFO	DATTYP	
Type	I	I	F	F	F	F	I	
Default	none	0	1.	1.	0.	0.	0	

Card 2, 3, 4, etc. Put one pair of points per card (2E20.0). Input is terminated when a “\*” card is found. (Use only two points for applying loads if the implicit arc-length method is active.)

Card 2...            1            2            3            4            5            6            7            8

Variable	A1	O1		
Type	F	F		
Default	0.0	0.0		

**VARIABLE****DESCRIPTION**

LCID	Load curve ID. Tables (see *DEFINE_TABLE) and load curves may not share common ID's. LS-DYNA allows load curve ID's and table ID's to be used interchangeably. A unique number has to be defined.
SIDR	Stress initialization by dynamic relaxation: EQ.0: load curve used in transient analysis only or for other applications, EQ.1: load curve used in stress initialization but not transient analysis, EQ.2: load curve applies to both initialization and transient analysis.
SFA	Scale factor for abscissa value. This is useful for simple modifications. EQ.0.0: default set to 1.0.
SFO	Scale factor for ordinate value (function). This is useful for simple modifications. EQ.0.0: default set to 1.0.
OFFA	Offset for abscissa values, see explanation below.
OFFO	Offset for ordinate values (function), see explanation below.
DATTYP	Data type. Usually 0, set to 1 <u>only</u> for general xy data. This affects how offsets are applied. General xy data curves refer to curves whose abscissa values do not increase monotonically. Generally, DATTYP=0 for time dependent curves, force versus displacement curves, and stress strain curves.
A1, A2,...	Abscissa values. Only pairs have to be defined, see remarks below.



---

<u>VARIABLE</u>	<u>DESCRIPTION</u>
O1, O2,...	Ordinate (function) values. Only pairs have to be defined, see remarks below.

**Remarks:**

- Warning:** In the definition of Load Curves used in the constitutive models, reasonable spacing of the points should always be observed, i.e., never set a single point off to a value approaching infinity. LS-DYNA uses internally discretized curves to improve efficiency in the constitutive models. Also, since the constitutive models extrapolate the curves, it is important to ensure that extrapolation does not lead to physically meaningless values, such as a negative flow stress. The number of points in each discretized curve is controlled by the parameter LCINT in \*CONTROL\_SOLUTION. By changing LCINT to a value greater than the default of 100, the discretized curves may better resemble the input curves. The data points of the discretized curves are written to messag and d3hsp if the parameter IPCURV is set to 1 in \*CONTROL\_OUTPUT.
- The load curve values are scaled after the offsets are applied, i.e.:  
$$\text{Abscissa value} = \text{SFA} \cdot (\text{Defined value} + \text{OFFA})$$
$$\text{Ordinate value} = \text{SFO} \cdot (\text{Defined value} + \text{OFFO})$$
- Positive offsets for the load curves (DATYYP=0) are intended for time versus function curves since two additional points are generated automatically at time zero and at time .999\*OFFA with the function values set to zero. If DATYYP=1, then the offsets do not create these additional points. Negative offsets for the abscissa simply shifts the abscissa values without creating additional points.
- Load curves are not extrapolated by LS-DYNA for applied loads such as pressures, concentrated forces, displacement boundary conditions, etc. Function values are set to zero if the time, etc., goes off scale. Therefore, extreme care must be observed when defining load curves. In the constitutive models, extrapolation is employed if the values on the abscissa go off scale.
- The load curve offsets and scale factors are ignored during restarts if the curve is redefined. See \*CHANGE\_CURVE\_DEFINITION in the restart section.

# \*DEFINE

# \*DEFINE\_CURVE\_COMPENSATION

## \*DEFINE\_CURVE\_COMPENSATION

Purpose: To define a curve for local compensation. All elements inside or outside of a curve can be compensated locally with a transitional region. This keyword must be used with \*INTERFACE\_COMPENSATION\_NEW.

Card 1            1            2            3            4            5            6            7            8

Variable	INOUT							
Type	I							
Default	none							

Card 2            1            2            3            4            5            6            7            8

Variable	X	Y	Z					
Type	F	F	F					
Default	none	none	none					

### VARIABLE

### DESCRIPTION

INOUT            EQ.1: elements inside the curve will be compensated  
EQ.2: elements outside the curve will be compensated

X,Y,Z            Coordinates of curve points

**\*DEFINE\_CURVE\_COMPENSATION\_CONSTRAINT\_{OPTION}**

Purpose: These two keywords allow for the definition of a localized die face region for springback compensation of stamping tools. These keywords together form a file to be used in \*INCLUDE\_COMPENSATION\_CURVE.

Options available include:

**\_BEGIN**

**\_END**

Card 1            1            2            3            4            5            6            7            8

Variable	CRVID	IN/OUT	TYPE					
Type	I	I	I					
Default	0	0	none					

Card 2            1            2            3            4            5            6            7            8

Variable	X	Y	Z					
Type	F	F	F					
Default	0.0	0.0	0.0					

**Card 3, 4, 5, etc. is defined for one pair of points per card. Input is terminated when a “\*” card is found.**

<b><u>VARIABLE</u></b>	<b><u>DESCRIPTION</u></b>
CRVID	Curve ID; must be unique, with the same begin and end point coordinates.
IN/OUT	Flag to indicate local area to be compensated: EQ.1: Compensate area includes enclosed curve under keyword ‘BEGIN’ and transition area between the two curves; no changes will be made to the area outside the curve under keyword ‘END’.

<u>VARIABLE</u>	<u>DESCRIPTION</u>
TYPE	Type code - must be "0".
X	X-coordinate of a point on the curve.
Y	Y-coordinate of a point on the curve.
Z	Z-coordinate of a point on the curve.

**Remarks:**

1. Sometimes springback occurs in a localized region of the die face. Since other parts of the die face do not need to be disturbed, a localized compensation makes the most sense to bring the part shape back to the design intent. A typical such example will be the front portion along the grill and headlamp, or the rear portion along the windshield of a trimmed hood inner panel. A decklid (or trunklid) inner also exhibits the similar needs. Iterative compensation scheme may be employed within this localized region to bring the springback panel back to design intent.
2. The keywords 'COMPENSATION\_CONSTRAINT\_BEGIN' and 'COMPENSATION\_CONSTRAINT\_END' must be used together in a file, which in turn will be included in keyword \*INCLUDE\_COMPENSATION\_CURVE. The keyword 'BEGIN' precedes the keyword 'END', each is defined by discrete points. In addition, each curve must form a closed loop. The area formed between the two curves is a transition area, and will be reflected in the compensated tooling. LS-PrePost (page2/curve) can be used to join multiple disconnected curves, and output in '.xyz' format required here.
3. The curve can be a 3-D piecewise linear curve with coordinates in X, Y and Z. However, Z-coordinates are ignored; meaning the tooling to be compensated must be positioned so draw direction is in global Z. Otherwise error will occur. In addition, it is assumed that both "blank before springback" and "blank after springback" will be smaller than rigid tools in dimension. It is noted the rigid tool meshes should be discretized fine enough to provide enough degrees of freedom for the compensation.
4. A complete input deck is provided below for a local compensation simulation. The keyword files state1.k and state2.k consist model (nodes and elements) information of the blank before and after springback, respectively. It is note here that if the blank is adaptively refined, the adaptive constraints must be included in the keyword files. The keyword file tools.k consists the stamping tools (with PID 1, 2, 3 and 4) all positioned in home position. The keyword file curvesxy.xyz consists keywords 'BEGIN' and 'END' defining the two closed-loop curves used to define a localized area.

```
*KEYWORD
*TITLE
LS-Dyna971 Compensation Job
$-----1-----2-----3-----4-----5-----6-----7-----8
```

```

*INTERFACE_COMPENSATION_NEW
$ METHOD SL SF ELREF PSIDm UNDCT ANGLE NOLINEAR
 6 10.000 0.700 0 1 0 0 1
*INCLUDE_COMPENSATION_BLANK_BEFORE_SPRINGBACK
state1.k
*INCLUDE_COMPENSATION_BLANK_AFTER_SPRINGBACK
state2.k
*INCLUDE_COMPENSATION_DESIRED_BLANK_SHAPE
state1.k
*INCLUDE_COMPENSATION_COMPENSATED_SHAPE
state1.k
*INCLUDE_COMPENSATION_CURRENT_TOOLS
tools.k
*INCLUDE_COMPENSATION_CURVE
curvesxy.xyz
*SET_PART_LIST
 1
1,2,3,4
*END

```

A portion of the file curvesxy.xyz is shown below,

```

*KEYWORD
*DEFINE_CURVE_COMPENSATION_CONSTRAINT_BEGIN
$ CID IN/OUT TYPE
 1 1 0
-1.86925e+02 1.83338e+03 -1.55520e+01
-1.83545e+02 1.83003e+03 -1.55469e+01
-1.80162e+02 1.82668e+03 -1.55428e+01
-1.91811e+02 1.83884e+03 -1.56014e+01
-1.90187e+02 1.83701e+03 -1.55852e+01
-1.88560e+02 1.83519e+03 -1.55688e+01
-1.86925e+02 1.83338e+03 -1.55520e+01
*DEFINE_CURVE_COMPENSATION_CONSTRAINT_END
$ CID IN/OUT TYPE
 2 1 0
-4.07730e+02 1.61371e+03 -8.04858e+01
-3.84480e+02 1.59890e+03 -7.99169e+01
-3.61193e+02 1.58423e+03 -7.93471e+01
-3.37832e+02 1.56984e+03 -7.87756e+01
-4.49289e+02 1.67556e+03 -8.04582e+01
-4.35672e+02 1.65473e+03 -8.05162e+01
-4.21764e+02 1.63396e+03 -8.05530e+01
-4.07730e+02 1.61371e+03 -8.04858e+01
*END

```

Note the 1<sup>st</sup> point and last point are exactly the same, forming a closed loop. Multi-region localized compensation is also possible by defining multiple pairs of the `_BEGIN` and `_END` keywords, each forming a localized region. For example, for localized compensation of two regions, the file curvesxy.xyz will read as follows,

```

*KEYWORD
*DEFINE_CURVE_COMPENSATION_CONSTRAINT_BEGIN
$ CID IN/OUT TYPE
 1 1 0
 3.67967e+02 1.63423e+03 -6.98532e+01
 3.60669e+02 1.62992e+03 -6.92921e+01
 3.53586e+02 1.62525e+03 -6.88777e+01
...

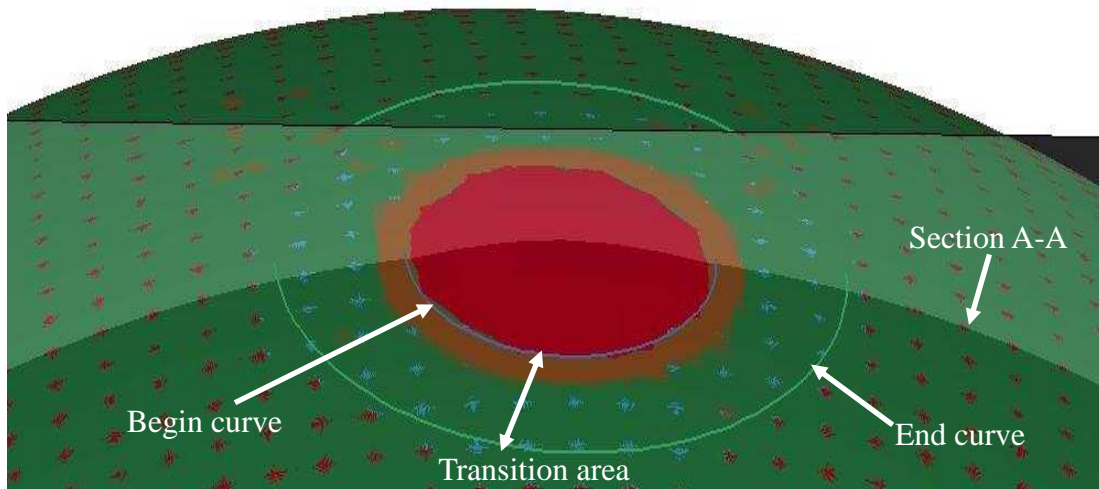
```

# \*DEFINE

## \*DEFINE\_CURVE\_COMPENSATION\_CONSTRAINT

```
*DEFINE_CURVE_COMPENSATION_CONSTRAINT_END
$      CID      IN/OUT      TYPE
      2          1          0
      4.12534e+02      1.75537e+03      -5.83975e+01
      3.98853e+02      1.75264e+03      -5.58860e+01
      3.85292e+02      1.74921e+03      -5.35915e+01
...
*DEFINE_CURVE_COMPENSATION_CONSTRAINT_BEGIN
$      CID      IN/OUT      TYPE
      3          1          0
     -4.37478e+02      2.67393e+03      -1.70421e+02
     -4.45605e+02      2.67209e+03      -1.71724e+02
     -4.53649e+02      2.66985e+03      -1.72894e+02
...
*DEFINE_CURVE_COMPENSATION_CONSTRAINT_END
$      CID      IN/OUT      TYPE
      4          1          0
     -4.49426e+02      2.79057e+03      -2.18740e+02
     -4.63394e+02      2.78749e+03      -2.20955e+02
     -4.77223e+02      2.78370e+03      -2.22938e+02
...
*END
```

5. An example below shows compensated result on a localized center portion of a rigid tool of a sphere shape. Compensation scale factor of 0.7 was used and smooth transition areas are achieved. Another example below shows the multi-region localized compensation results.



**Figure 13.3.** Localized Compensation Illustration

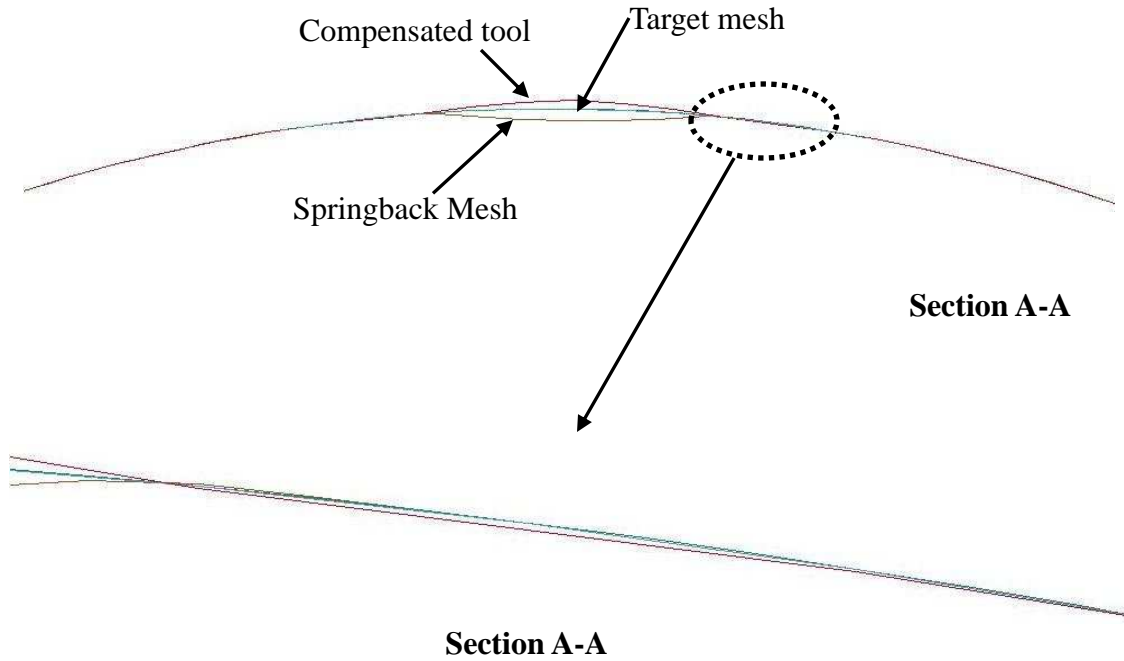


Figure 13.4. Localized Compensation Results along Section A-A

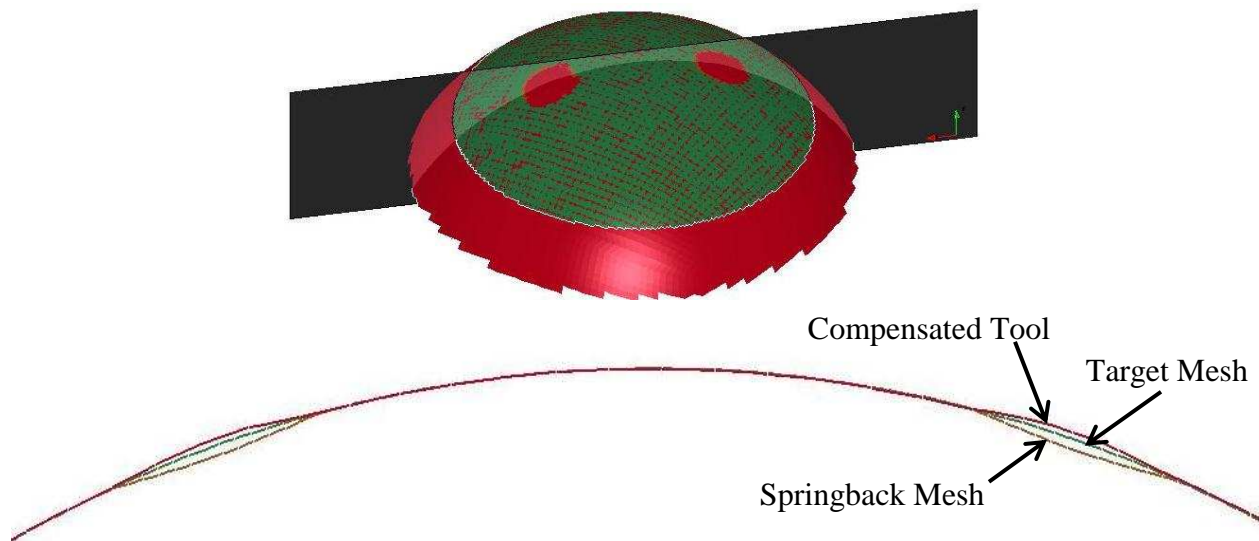


Figure 13.5. Multi-region Localized Compensation

# \*DEFINE

## \*DEFINE\_CURVE\_DRAWBEAD

### \*DEFINE\_CURVE\_DRAWBEAD

Purpose: This keyword simplifies the creation of drawbead, previously requires a few keywords to define.

Card 1            1            2            3            4            5            6            7            8

Variable	CID	TCTYPE	VID	PID	BLKID	PERCT	LCID	
Type	I	I	I	I	I	F	I	
Default	none	none	none	none	none	0.0	none	

**Card 2,3,4, etc., define if and only if TCTYPE=1, with one pair of X,Y,Z data per card. Input is terminated when a "\*" card is found.**

Card 2            1            2            3            4            5            6            7            8

Variable	CX	CY						
Type	F	F						
Default	0.0	0.0						

**Card 2 defined if and only if TCTYPE=2.**

Card 2            1            2            3            4            5            6            7            8

Variable	FILENAME							
Type	C							
Default	none							



<u>VARIABLE</u>	<u>DESCRIPTION</u>
CID	Draw bead curve ID; must be unique for each draw bead segment.
TCTYPE	Flag to indicate input curve data format: EQ.1: XYZ data, EQ.2: IGES format data.
VID	Vector ID, as defined by *DEFINE_VECTOR. This vector is used to project the supplied curves to the rigid tool, defined by variable PID.
PID	Part ID of the rigid tool to which the curves are projected and attached.
BLKID	Part set ID of the blank.
PERCT	Draw bead lock percentage or draw bead force. GT.0: Percentage of the full lock force for this segment of the bead definition. This is the ratio of desired restraining force over the full lock force. The value should be between 0.0 and 100.0. LT.0: Absolute value is the draw bead force.
LCID	Load curve ID defining material hardening curve of the sheet blank.

**Remarks:**

1. Draw bead curve in space either in XYZ or IGES data format is projected to the rigid tool (binder). Extra node sets are created and attached to the binder. By referring to the material hardening curve of the sheet blank in the keyword, full lock force is calculated, along with restraining force curve and normal bead force curve created automatically. In addition to the two \*DEFINE\_CURVE cards for the forces, there is no need to define \*CONTACT\_DRAWBEAD and \*CONSTRAINED\_RIGID\_BODIES since they are treated internally within the code now.
2. LS-PrePost (page2/curve) can be used to break or join multiple disconnected curves, and output in 'XYZ' format.
3. The following partial keyword example defines six draw beads to restrain blank with PID 63, with strain hardening curve ID 400. The draw beads are projected along vector ID 991, in IGES format, and are attached to a rigid tool with PID 3.

```

$---+---1---+---2---+---3---+---4---+---5---+---6---+---7---+---8
*KEYWORD
*parameter
I blkpid          63
I vid             991
*define_vector
991,0.0,0.0,0.0,0.0,0.0,10.0

```

# \*DEFINE

# \*DEFINE\_CURVE\_DRAWBEAD

```
*define_curve_drawbead
$      CID      TCTYPE      VID      PID      BLKID      PERCT      LCID
      98         2      991         3         63      52.442      400
bead1.iges
*define_curve_drawbead
$      CID      TCTYPE      VID      PID      BLKID      PERCT      LCID
      99         2      991         3         63      72.1080     400
bead2.iges
*define_curve_drawbead
$      CID      TCTYPE      VID      PID      BLKID      PERCT      LCID
     100         2      991         3         63      65.55       400
bead3.iges
*define_curve_drawbead
$      CID      TCTYPE      VID      PID      BLKID      PERCT      LCID
     101         2      991         3         63      65.55       400
bead4.iges
*define_curve_drawbead
$      CID      TCTYPE      VID      PID      BLKID      PERCT      LCID
     102         2      991         3         63      55.72       400
bead5.iges
*define_curve_drawbead
$      CID      TCTYPE      VID      PID      BLKID      PERCT      LCID
     103         2      991         3         63      72.108      400
bead6.iges
*END
```

4. This feature is available in LS-DYNA R5 Revision 62464 and later releases.

**\*DEFINE\_CURVE\_DUPLICATE**

Purpose: Define a curve by optionally scaling and offsetting the abscissa and ordinates of another curve defined by the \*DEFINE\_CURVE keyword.

Card 1            1            2            3            4            5            6            7            8

Variable	LCID	RLCID	SFA	SFO	OFFA	OFFO		
Type	I	I	F	F	F	F		
Default	none	none	1.	1.	0.	0.		

<u>VARIABLE</u>	<u>DESCRIPTION</u>
LCID	Load curve ID. Tables (see *DEFINE_TABLE) and load curve ID's must be unique.
RLCID	Reference load curve ID.
SFA	Scale factor for abscissa value of curve ID, RLCID. This value scales the SFA value defined for RLCID. EQ.0.0: default set to 1.0.
SFO	Scale factor for ordinate value (function) of curve ID, RLCID. This value scales the SFO value defined for RLCID. EQ.0.0: default set to 1.0.
OFFA	Offset for abscissa values. This value is added to the OFFA value defined for RLCID.
OFFO	Offset for ordinate values (function). This value is added to the OFFO value defined for RLCID.

# \*DEFINE

## \*DEFINE\_CURVE\_ENTITY

### \*DEFINE\_CURVE\_ENTITY

Purpose: Define a curve of straight line segments and circular arcs that defines an axisymmetric surface. This curve can only be used with the keyword, \*CONTACT\_ENTITY for the load curve entity, GEOTYP=11. This option is in the third release.

Card            1            2            3            4            5            6            7            8

Variable	LCID	SFA	SFO	SFR	OFFA	OFFO	OFFR	
Type	I	F	F	F	F	F	F	
Default	none	1.	1.	1.	0.	0.	0.	

**Card 2, 3, 4, etc. Put one pair of points per card (3E20.0,I20). Input is terminated when a “\*” card is found.**

Card            1            2            3            4            5            6            7            8

Variable	Ai	Oi	Ri	IFLAG
Type	F	F	F	I
Default	0.0	0.0	optional	Required if  R1 >0

#### VARIABLE

#### DESCRIPTION

LCID	Load curve ID. Tables (see *DEFINE_TABLE) and load curves may not share common ID's. LS-DYNA allows load curve ID's and table ID's to be used interchangeably. A unique number has to be defined.
SFA	Scale factor for axis value. This is useful for simple modifications. EQ.0.0: default set to 1.0.
SFO	Scale factor for radius values. This is useful for simple modifications. EQ.0.0: default set to 1.0.
SFR	Scale factor for circular radius. This is useful for simple modifications. EQ.0.0: default set to 1.0.

---

<u>VARIABLE</u>	<u>DESCRIPTION</u>
OFFA	Offset for axis values, see explanation below.
OFFO	Offset for radius values, see explanation below.
OFFR	Offset for circular radius, see explanation below.
Ai	Z-axis coordinates along the axis of rotation.
Oi	Radial coordinates from the axis of rotation
Ri	Radius of arc between points (Ai,Oi) and (Ai+1,Oi+1). If zero, a straight line segment is assumed.
IFLAG	Defined if  Ri >0. Set to 1 if center of arc is inside axisymmetric surface and to -1 if the center is outside the axisymmetric surface.

**Remarks:**

1. The load curve values are scaled after the offsets are applied, i.e.:

$$\text{Axis value} = \text{SFA} \cdot (\text{Defined value} + \text{OFFA})$$

$$\text{Radius value} = \text{SFO} \cdot (\text{Defined value} + \text{OFFO})$$

$$\text{Circular radius} = \text{SFR} \cdot (\text{Defined value} + \text{OFFR})$$

# \*DEFINE

## \*DEFINE\_CURVE\_FEEDBACK

### \*DEFINE\_CURVE\_FEEDBACK

Purpose: Define information that is used as the solution evolves to scale the ordinate values of the specified load curve ID. One application for this capability is in sheet metal stamping.

Card 1            1            2            3            4            5            6            7            8

Variable	LCID	PID	BOXID	FLDID				
Type	I	I	I	I				
Default	none	none	0	none				

Card 2            1            2            3            4            5            6            7            8

Variable	FSL	TSL	SFF	SFT	BIAS			
Type	F	F	F	F	F			
Default	none	none	1.0	1.0	0.0			

#### VARIABLE

#### DESCRIPTION

LCID	ID number for load curve to be scaled.
PID	Active part ID for load curve control
BOXID	Box ID. Elements of specified part ID contained in box are checked. If the box ID is set to zero the all elements of the active part are checked.
FLDID	Load curve ID which defines the flow limit diagram as shown in Figure 13.6.
FSL	If the strain ratio, $\varepsilon_{major\_workpiece} / \varepsilon_{major\_fld}$ exceeds FSL, the scale factor for flow, $SF$ , is active.
TSL	Thickness strain limit. If the through thickness strain is exceeded the scale factor for thickening, $ST$ , is active.

---

<u>VARIABLE</u>	<u>DESCRIPTION</u>
SFF	Scale factor for the flow limit diagram, $SF$ (Default=1.0).
SFT	Scale factor for thickening, $ST$ (Default=1.0).
BIAS	Bias for combined flow and thickening, $S$ , $-1 \leq S \leq 1$ .

**Remarks:**

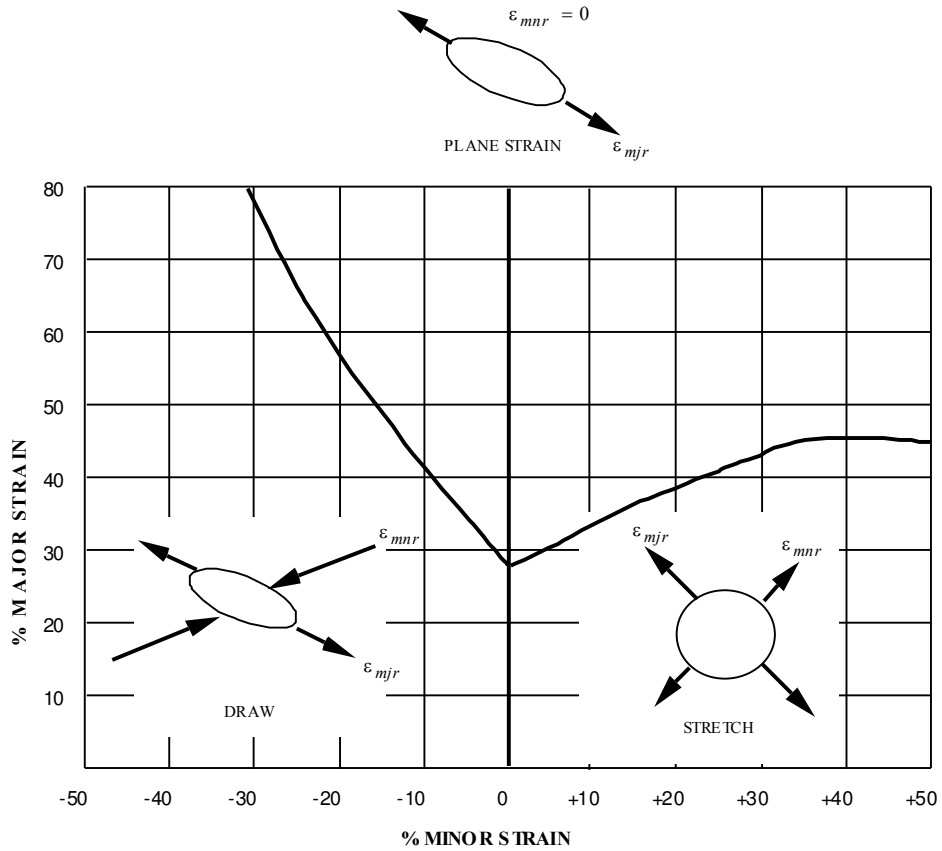
The scale factor for the load curve ordinate value is updated as:

$$S_{load\ curve}^{n+1} = S_{load\ curve}^n \cdot S_{final}$$

where  $S_{final}$  is equal to  $SF$  if the strain ratio is exceeded or to  $ST$  if the thickness strain limit is exceeded. The bias value determines the final scale factor,  $S_{final}$ , in the event that the thickness and flow limit diagram criteria both satisfied. In this case the scale factor for the load curve is given by:

$$S_{final} = \frac{1}{2}(1 - S) \cdot SF + \frac{1}{2}(1 + S)ST$$

Generally,  $SF$  is slightly less than unity and  $ST$  is slightly greater than unity so that  $S_{load\ curve}$  changes insignificantly from time step to time step.



**Figure 13.6.** Flow limit diagram



**\*DEFINE\_CURVE\_FLC**

Purpose: This keyword allows for defining Forming Limit Diagram (FLD) using sheet metal thickness and strain hardening value 'n'.

Card 1            1            2            3            4            5            6            7            8

Variable	LCID	TH	N					
Type	I	F	F					
Default	none	0.0	0.0					

<u>VARIABLE</u>	<u>DESCRIPTION</u>
LCID	Load curve ID.
TH	Sheet metal thickness.
N	Strain hardening value of the sheet metal, as in power law.

**Remarks:**

1. This keyword is used in conjunction with keyword **\*MAT\_TRANSVERSELY\_ANISOTROPIC\_ELASTIC\_PLASTIC\_NLP\_FAILURE**. For detailed formula of calculating the FLD based on sheet metal thickness and n-value, please refer to the following paper: Ming F. Shi, Shawn Gelisse, "Issues on the AHSS Forming Limit Determination", IDDRG 2006.
2. It is noted that this FLD calculation method is limited to sheet metal steels with thickness equal to or less than 2.5 mm, and it is not suitable for aluminum sheets.
3. In an example below, the FLD is defined using a thickness value of 1.5 and n-value of 0.159. The 'LCID' of 891 is used to define a variable 'ICFLD' in keyword **\*MAT\_TRANSVERSELY\_ANISOTROPIC\_ELASTIC\_PLASTIC\_NLP\_FAILURE**.

```
*DEFINE_CURVE_FLC
$ LCID, TH, N
891, 1.5, 0.159
```

4. For aluminum sheets, **\*DEFINE\_CURVE** can be used to input the FLD for the variable 'ICFLD' in **\*MAT\_TRANSVERSELY\_ANISOTROPIC\_ELASTIC\_PLASTIC\_NLP\_FAILURE**.

5. This feature is available in LS-DYNA R5 Revision 61435 and later releases.



---

<b>VARIABLE</b>	<b>DESCRIPTION</b>
FUNCTION	Arithmetic expression involving a combination of the following possibilities.

### Constants and Variables

---

<b>FUNCTION</b>	<b>DESCRIPTION</b>
TIME	Current simulation time
PI	Proportionality constant relating the circumference of a circle to its diameter
DTOR	Degrees to radians conversion factor (PI/180.)
RTOD	Radians to degrees conversion factor (180./PI)

### Intrinsic Functions

---

<b>FUNCTION</b>	<b>DESCRIPTION</b>
ABS(a)	Absolute value of (a)
AINT(a)	Nearest integer whose magnitude is not larger than (a)
ANINT(a)	Nearest whole number to (a)
MOD(a1,a2)	Remainder when a1 is divided by a2
SIGN(a1,a2)	Transfer sign of a2 to magnitude of a1
MAX(a1,a2)	Maximum of a1 and a2
MIN(a1,a2)	Minimum of a1 and a2
SQRT(a)	Square root of (a)
EXP(a)	e raised to the power of (a)
LOG(a)	Natural logarithm of (a)
LOG10(a)	Log base 10 of (a)
SIN(a)	Sine of (a)

<b>FUNCTION</b>	<b>DESCRIPTION</b>
COS(a)	Cosine of (a)
TAN(a)	Tangent of (a)
ASIN(a)	Arc sine of (a)
ACOS(a)	Arc cosine of (a)
ATAN(a)	Arc tangent of (a)
ATAN2(a1,a2)	Arc tangent of (a1/a2)
SINH(a)	Hyperbolic sine of (a)
COSH(a)	Hyperbolic cosine of (a)
TANH(a)	Hyperbolic tangent of (a)

### Load Curves

<b>FUNCTION</b>	<b>DESCRIPTION</b>
LCn	Ordinate value of curve n defined elsewhere (see *DEFINE_CURVE)

### Coordinate Functions

<b>FUNCTION</b>	<b>DESCRIPTION</b>
CX(n1)	Value of x-coordinate for node n1.
CY(n1)	Value of y-coordinate for node n1.
CZ(n1)	Value of z-coordinate for node n1.

### Displacement Functions

<b>FUNCTION</b>	<b>DESCRIPTION</b>
DM(n1[,n2])	Magnitude of translational displacement of node n1 relative to node n2. Node n2 is optional and if omitted the displacement is computed relative to ground.

---

<b>FUNCTION</b>	<b>DESCRIPTION</b>
DMRB(pid)	Magnitude of translational displacement of rigid body pid
DX(n1[,n2,n3])	x-translational displacement of node n1 relative to node n2 expressed in the local coordinate system of node n3. If node n2 is omitted it defaults to ground. If node n3 is not specified the displacement is reported in the global coordinate system.
DY(n1[,n2,n3])	y-translational displacement of node n1 relative to node n2 expressed in the local coordinate system of node n3. If node n2 is omitted it defaults to ground. If node n3 is not specified the displacement is reported in the global coordinate system.
DZ(n1[,n2,n3])	z-translational displacement of node n1 relative to node n2 expressed in the local coordinate system of node n3. If node n2 is omitted it defaults to ground. If node n3 is not specified the displacement is reported in the global coordinate system.
DXRB(pid)	x-translational displacement of rigid body pid
DYRB(pid)	y-translational displacement of rigid body pid
DZRB(pid)	z-translational displacement of rigid body pid
AX(n1[,n2])	Rotation displacement of node n1 about the local x-axis of node n2. If n2 is not specified then it defaults to ground. In computing this value it is assumed the rotation about the other two axes (y-, z-axes) of node n2 is zero.
AY(n1[,n2])	Rotation displacement of node n1 about the local y-axis of node n2. If n2 is not specified then it defaults to ground. In computing this value it is assumed the rotation about the other two axes (x-, z-axes) of node n2 is zero.
AZ(n1[,n2])	Rotation displacement of node n1 about the local z-axis of node n2. If n2 is not specified then it defaults to ground. In computing this value it is assumed the rotation about the other two axes (x-, y-axes) of node n2 is zero.
PSI(n1[,n2])	First angle in the body2:313 Euler rotation sequence which orients node n1 in the frame of node n2. If n2 is omitted it defaults to ground.
THETA(n1[,n2])	Second angle in the body2:313 Euler rotation sequence which orients node n1 in the frame of node n2. If n2 is omitted it defaults to ground.

<b>FUNCTION</b>	<b>DESCRIPTION</b>
PHI(n1[,n2])	Third angle in the body2:313 Euler rotation sequence which orients node n1 in the frame of node n2. If n2 is omitted it defaults to ground.
YAW(n1[,n2])	First angle in the body3:321 yaw-pitch-roll rotation sequence which orients node n1 in the frame of node n2. If n2 is omitted it defaults to ground.
PITCH(n1[,n2])	Second angle in the body3:321 yaw-pitch-roll rotation sequence which orients node n1 in the frame of node n2. If n2 is omitted it defaults to ground.
ROLL(n1[,n2])	Third angle in the body3:321 yaw-pitch-roll rotation sequence which orients node n1 in the frame of node n2. If n2 is omitted it defaults to ground.

### Velocity Functions

<b>FUNCTION</b>	<b>DESCRIPTION</b>
VM(n1[,n2])	Magnitude of translational velocity of node n1 relative to node n2. Node n2 is optional and if omitted the velocity is computed relative to ground.
VR(n1[,n2])	Relative radial translational velocity of node n1 relative to node n2. If node n2 is omitted it defaults to ground.
VX(n1[,n2,n3])	x-component of the difference between the translational velocity vectors of node n1 and node n2 in the local coordinate system of node n3. If node n2 is omitted it defaults to ground. Node n3 is optional and if not specified the global coordinate system is used.
VY(n1[,n2,n3])	y-component of the difference between the translational velocity vectors of node n1 and node n2 in the local coordinate system of node n3. If node n2 is omitted it defaults to ground. Node n3 is optional and if not specified the global coordinate system is used.
VZ(n1[,n2,n3])	z-component of the difference between the translational velocity vectors of node n1 and node n2 in the local coordinate system of node n3. If node n2 is omitted it defaults to ground. Node n3 is optional and if not specified the global coordinate system is used.
WM(n1[,n2])	Magnitude of angular velocity of node n1 relative to node n2. Node n2 is optional and if omitted the angular velocity is computed relative to ground.

<b>FUNCTION</b>	<b>DESCRIPTION</b>
WX(n1[,n2,n3])	x-component of the difference between the angular velocity vectors of node n1 and node n2 in the local coordinate system of node n3. If node n2 is omitted it defaults to ground. Node n3 is optional and if not specified the global coordinate system is used.
WY(n1[,n2,n3])	y-component of the difference between the angular velocity vectors of node n1 and node n2 in the local coordinate system of node n3. If node n2 is omitted it defaults to ground. Node n3 is optional and if not specified the global coordinate system is used.
WZ(n1[,n2,n3])	z-component of the difference between the angular velocity vectors of node n1 and node n2 in the local coordinate system of node n3. If node n2 is omitted it defaults to ground. Node n3 is optional and if not specified the global coordinate system is used.

### Acceleration Functions

<b>FUNCTION</b>	<b>DESCRIPTION</b>
ACCM(n1[,n2])	Magnitude of translational acceleration of node n1 relative to node n2. Node n2 is optional and if omitted the acceleration is computed relative to ground.
ACCX(n1[,n2,n3])	x-component of the difference between the translational acceleration vectors of node n1 and node n2 in the local coordinate system of node n3. If node n2 is omitted it defaults to ground. Node n3 is optional and if not specified the global coordinate system is used.
ACCY(n1[,n2,n3])	y-component of the difference between the translational acceleration vectors of node n1 and node n2 in the local coordinate system of node n3. If node n2 is omitted it defaults to ground. Node n3 is optional and if not specified the global coordinate system is used.
ACCZ(n1[,n2,n3])	z-component of the difference between the translational acceleration vectors of node n1 and node n2 in the local coordinate system of node n3. If node n2 is omitted it defaults to ground. Node n3 is optional and if not specified the global coordinate system is used.
WDTM(n1[,n2])	Magnitude of angular acceleration of node n1 relative to node n2. Node n2 is optional and if omitted the angular acceleration is computed relative to ground.
WDTX(n1[,n2,n3])	x-component of the difference between the angular acceleration vectors



<b>FUNCTION</b>	<b>DESCRIPTION</b>
	of node n1 and node n2 in the local coordinate system of node n3. If node n2 is omitted it defaults to ground. Node n3 is optional and if not specified the global coordinate system is used.
WDTY(n1[,n2,n3])	y-component of the difference between the angular acceleration vectors of node n1 and node n2 in the local coordinate system of node n3. If node n2 is omitted it defaults to ground. Node n3 is optional and if not specified the global coordinate system is used.
WDTZ(n1[,n2,n3])	z-component of the difference between the angular acceleration vectors of node n1 and node n2 in the local coordinate system of node n3. If node n2 is omitted it defaults to ground. Node n3 is optional and if not specified the global coordinate system is used.

### Generic Force Functions

<b>FUNCTION</b>	<b>DESCRIPTION</b>
FM(n1[,n2])	Magnitude of net translational force acting between node n1 and n2. Node n2 is optional and if omitted the force that acting only on n1.
FX(n1[,n2,n3])	x-component of the net translational force acting at node n1 as computed in the optional local system of node n3. If n2 is specified then all forces acting between n1 and n2 are included in the force computation.
FY(n1[,n2,n3])	y-component of the of the net translational force acting at node n1 as computed in the optional local system of node n3. If n2 is specified then all forces acting between n1 and n2 are included in the force computation.
FZ(n1[,n2,n3])	z-component of the of the net translational force acting at node n1 as computed in the optional local system of node n3. If n2 is specified then all forces acting between n1 and n2 are included in the force computation.
TM(n1[,n2])	Magnitude of net torque acting between node n1 and n2. Node n2 is optional and if omitted the torque that acting only on n1.
TX(n1[,n2,n3])	x-component of the net torque acting at node n1 as computed in the optional local system of node n3. If n2 is specified then all forces acting between n1 and n2 are included in the torque computation.

<b>FUNCTION</b>	<b>DESCRIPTION</b>
TY(n1[,n2,n3])	y-component of the net torque acting at node n1 as computed in the optional local system of node n3. If n2 is specified then all forces acting between n1 and n2 are included in the torque computation.
TZ(n1[,n2,n3])	z-component of the net torque acting at node n1 as computed in the optional local system of node n3. If n2 is specified then all forces acting between n1 and n2 are included in the torque computation.

### Sensor Functions

<b>FUNCTION</b>	<b>DESCRIPTION</b>
SENSOR(cntlid)	Returns a value=1.0 if *SENSOR_CONTROL cntlid has a status of on. If status is off, function returns a value = TYPEID where TYPEID is an input parameter in *SENSOR_CONTROL.

### Contact Force Functions

<b>FUNCTION</b>	<b>DESCRIPTION</b>
RCFORC(id,ims,comp,local)	<p>Returns the component comp (see description below) of contact interface id (see *CONTACT_..._ID) as calculated in the local coordinate system local (see *DEFINE_COORDINATE_...). If local equals zero then forces are reported in the global coordinate system. Forces are reported for the slave side when ims=1 or master side when ims=2.</p> <p>Following are the admissible values of comp and their corresponding force component.</p> <ul style="list-style-type: none"> <li>1: x force component</li> <li>2: y force component</li> <li>3: z force component</li> <li>4: resultant force</li> </ul>

**Element Specific Functions**

<u>FUNCTION</u>	<u>DESCRIPTION</u>
BEAM(id,jflag,comp,rm)	<p>Returns the force component comp (see description below) of beam id as calculated in the local coordinate system rm. Forces are reported in the global coordinate system if rm is zero. If rm equals -1 the beam's r, s, and t force/moment is returned. If jflag is set to zero then the force/torque acting on n1 end of the beam is returned, else if jflag is set to unity the force/torque on the n2 end of the beam is returned. See *ELEMENT_BEAM for the nodal connectivity rule defining n1 and n2.</p> <p>Admissible values of comp are 1-8 and correspond to the following components.</p> <ul style="list-style-type: none"><li>1: force magnitude</li><li>2: x force (axial r-force, rm=-1)</li><li>3: y force (s-shear force, rm=-1)</li><li>4: z force (t-shear force, rm=-1)</li><li>5: torque magnitude</li><li>6: x torque (torsion, rm=-1)</li><li>7: y torque (s-moment, rm=-1)</li><li>8: z torque (t-moment, rm=-1)</li></ul>

<u>FUNCTION</u>	<u>DESCRIPTION</u>
ELHIST(eid,etype,comp,ipt,local)	<p>Returns the elemental quantity comp (see description below) of element eid as calculated in the local coordinate system local. Quantities are reported in the global coordinate system if local is zero. The parameter ipt specifies whether the quantity is for particular integration point or maximum, minimum, or averaging is applied across the integration points.</p> <p>The following element classes, specified with etype, are supported.</p> <ul style="list-style-type: none"><li>0: solid</li><li>2: thin shell</li></ul> <p>Following are admissible values of comp and the corresponding elemental quantity.</p> <ul style="list-style-type: none"><li>1-6: x, y, z, xy, yz, and zx stress, respectively</li><li>7: effective plastic strain</li><li>8: hydrostatic pressure</li><li>10: effective stress</li><li>45-50: lower surface x,y,z,xy,yz,zx strain</li><li>51-56: upper surface x,y,z,xy,yz,zx strain</li><li>57-62: middle surface x,y,z,xy,yz,zx strain</li></ul> <p>Integration point options, specified with ipt, follow.</p> <ul style="list-style-type: none"><li>ge.1: quantity is reported for integration point number ipt</li><li>eq.-1: maximum of all integration points (default)</li><li>eq.-2: average of all integration points</li><li>eq.-3: minimum of all integration points</li><li>eq.-4: lower surface integration point</li><li>eq.-5: upper surface integration point</li><li>eq.-6: middle surface integration point</li></ul> <p>The local coordinate option local currently defaults to the global coordinate system for solid elements and other coordinate system options are unavailable. In the case of thin shell elements the quantity is reported only in the element local coordinate system.</p> <ul style="list-style-type: none"><li>eq.1: global coordinate system (solid elements)</li><li>eq.2: element coordinate system (thin shell elements)</li></ul>

<b>FUNCTION</b>	<b>DESCRIPTION</b>
JOINT(id,jflag,comp,rm)	Returns the force component comp (see description below) due to rigid body joint id as calculated in the local coordinate system rm. If jflag is set to zero then the force/torque acting on n1 end of the joint is returned. The force/torque on the n2 end of the joint is returned if jflag is set to 1. See *CONSTRAINED_JOINT for the rule defining n1 and n2.

### Nodal Specific Functions

<b>FUNCTION</b>	<b>DESCRIPTION</b>
TEMP(nid)	Returns the temperature of node nid

### General Functions

<b>FUNCTION</b>	<b>DESCRIPTION</b>
CHEBY(x,x0,a0,...,a30)	<p>Evaluates a Chebyshev polynomial at the user specified value x. The parameters x0, a0, a1, ..., a30 are used to define the constants for the polynomial defined by:</p> $C(x) = \sum a_j T_j(x - x_0)$ <p>where the functions <math>T_j</math> is defined recursively as</p> $T_j(x - x_0) = 2 \cdot (x - x_0) \cdot T_{j-1}(x - x_0) - T_{j-2}(x - x_0)$ <p>where</p> $T_0(x - x_0) = 1$ $T_1(x - x_0) = x - x_0$
FORCOS(x,x0,(a0,...,a30))	<p>Evaluates a Fourier cosine series at the user specified value x. The parameters x0, a0, a1, ..., a30 are used to define the constants for the series defined by:</p> $F(x) = \sum a_j T_j(x - x_0)$ <p>where</p> $T_j(x - x_0) = \cos[j \cdot \omega \cdot (x - x_0)]$

FORSIN(x,x0,(a0,...,a30)

Evaluates a Fourier sine series at the user specified value x. The parameters x0, a0, a1, ..., a30 are used to define the constants for the series defined by:

$$F(x) = \sum a_j T_j(x - x_0)$$

where

$$T_j(x - x_0) = \sin [j \cdot \omega \cdot (x - x_0)]$$

IF(lcid1,lcid2,lcid3,lcid4)

Arithmetic if conditional where lcid# is the load curve ID for \*DEFINE\_CURVE or \*DEFINE\_CURVE\_FUNCTION.

Returns the ordinate value of lcid2 if ordinate value of lcid1<0

Returns the ordinate value of lcid3 if ordinate value of lcid1=0

Returns the ordinate value of lcid4 if ordinate value of lcid1>0

POLY(x,x0,a0,...,a30)

Evaluates a standard polynomial at the user specified value x. The parameters x0, a0, a1, ..., a30 are used to define the constants for the polynomial defined by:

$$P(x) = a_0 + a_1(x - x_0) + a_2(x - x_0)^2 + \dots + a_n(x - x_0)^n$$

SHF(x,x0,a,(phi),b)

Evaluates a Fourier sine series at the user specified value x. The parameters x0, a0, a1, ..., a30 are used to define the constants for the series defined by:

$$SHF = a \cdot \sin [\omega \cdot (x - x_0) - \text{phi}] + b$$

STEP(x,x0,h0,x1,h1)

Approximates the Heavyside function with a cubic polynomial using the equation:

$$\text{STEP} = \left\langle \begin{array}{l} h_0 \\ h_0 + (h_1 - h_0) \cdot \left[ \frac{(x - x_0)}{(x_1 - x_0)} \right]^2 \cdot \left\{ 3 - 2 \cdot \left[ \frac{(x - x_0)}{(x_1 - x_0)} \right] \right\}; x_0 < x < x_1 \\ h_1 \end{array} \right\rangle \left\langle \begin{array}{l} x \leq x_0 \\ x_0 < x < x_1 \\ x \geq x_1 \end{array} \right\rangle$$

**Remarks:**

1. A local coordinate system must be attached to nodes if they are referenced by functions involving rotational motion, for example, angular displacement or angular velocity. The local coordinate system is attached to the node using \*DEFINE\_COORDATE\_NODES and FLAG=1 is a requirement. Furthermore, the three nodes which comprise the coordinate system must lie on the same body. Similarly, a local coordinate system must also be attached to node n3 if n3 is referenced in functions: DX, DY, DZ, VX, VY, VZ, WX, WY, WZ, ACCX, ACCY, ACCZ, WDTX, WDTY, WDTZ, FX, FY, FZ, TX, TY, or TZ.

2. Unless otherwise noted units of radians are always used for the arguments and output of functions involving angular measures.
3. The following examples serve only as an illustration of syntax.

Example 1: Define a curve 10 whose ordinate is  $0.5 \cdot (\text{ordinate of curve 9}) \cdot (\text{magnitude of translational velocity of node 22})^3$ .

```
*DEFINE_CURVE_FUNCTION
10
0.5*lc9*vm(22)**3
```

Example 2: Define a curve 101 whose ordinate is  $-2 \cdot (\text{z-translational displacement of node 38}) \cdot \sin(20\pi t)$ .

```
*DEFINE_CURVE_FUNCTION
101
-2.*dz(38)*sin(2.*pi*10.*time)
```

**\*DEFINE\_CURVE\_SMOOTH**

Purpose: Define a smoothly varying curve using few parameters. This shape is useful for velocity control of tools in metal forming applications.

Card            1            2            3            4            5            6            7            8

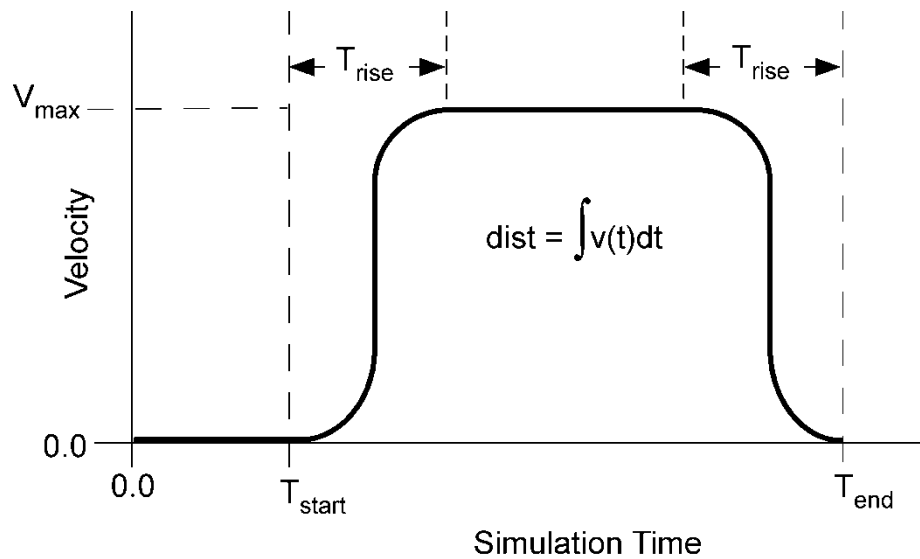
Variable	LCID	SIDR	DIST	TSTART	TEND	TRISE	V0	
Type	I	I	F	F	F	F	F	
Default	none	none	none	none	none	none	none	

**VARIABLE****DESCRIPTION**

LCID	Load curve ID, must be unique.
SIDR	Stress initialization by dynamic relaxation: EQ.0: load curve used in transient analysis only or for other applications, EQ.1: load curve used in stress initialization but not transient analysis, EQ.2: load curve applies to both initialization and transient analysis.
DIST	Total distance tool will travel (area under curve).
TSTART	Time curve starts to rise
TEND	Time curve returns to zero. If TEND is nonzero, VMAX will be computed automatically to satisfy required travel distance DIST. Input either TEND or VMAX.
TRISE	Rise time
VMAX	Maximum velocity (maximum value of curve). If VMAX is nonzero, TEND will be computed automatically to satisfy required travel distance DIST. Input either TEND or VMAX.



Remarks:



**Figure 13.7.** Smooth curve created automatically using \*DEFINE\_CURVE\_SMOOTH. This shape is commonly used to control velocity of tools in metal forming applications as shown in the above graph, but can be used for other applications in place of any standard load curve.

# \*DEFINE

# \*DEFINE\_CURVE\_TRIM

## \*DEFINE\_CURVE\_TRIM\_{OPTION}

Available options include:

<BLANK>

3D

NEW

Purpose: This keyword is developed to define curves for trimming. When the option `_3D` is used, the trimming is processed based on the element normal rather than a vector. The option `_NEW` is used to trim in a fixed direction specified by a vector, and is also called 2D trimming.

Card 1            1            2            3            4            5            6            7            8

Variable	TCID	TCTYPE	TFLG	TDIR	TCTOL	TOLN/IGB	NSEED1	NSEED2
Type	I	I	I	I	F	F	I	I
Default	none	none	none	none	0.25	2.0 / 0	NONE	NONE
Remarks				Fig. 13.8	7, Fig.13.9		3	3

**Card 2, 3, 4, etc. defined if and only if TCTYPE=1. Put one pair of points per card (2E20.0). Input is terminated when a “\*” card is found.**

Card 2...        1            2            3            4            5            6            7            8

Variable	CX	CY		
Type	F	F		
Default	0.0	0.0		

Defined if and only if TCTYPE=2.

Card 2            1            2            3            4            5            6            7            8

Variable	FILENAME						
Type	C						

<u>VARIABLE</u>	<u>DESCRIPTION</u>
TCID	ID number for trim curve.
TCTYPE	Trim curve type: EQ.1: digitized curve provided, EQ.2: IGES trim curve.
TFLG	Element removal option: EQ. -1: remove material outside curve, EQ. 1: remove material inside curve.
TDIR	ID of vector (*DEFINE_VECTOR) giving direction of projection for trim curve (see Figure 13.8). EQ. 0: default vector (0,0,1) is used. Curve is defined in global XY plane, and projected onto mesh in global Z-direction to define trim line.
TCTOL	Tolerance limiting size of small elements created during trimming (see Figure 13.9). LT.0: "simple" trimming, producing jagged edge mesh When used together with *CONTROL_ADAPTIVE_CURVE, it is a distance from the curve out (both sides). Within this distance the blank mesh will be refined. See <b>Remark 7</b> below.
TOLN / IGB	If option <b>_3D</b> is used, TOLN represents the maximum gap between the trimming curve and the mesh. If the gap is bigger than this value, this section in the curve will not be used. If option <b>_NEW</b> is used, then the variable IGB is defined as follows: IGB.EQ.0: trimming curve is defined in local coordinate system. This is the default value. If this value is chosen for IGB, then the variable TDIR and the keyword *DEFINE_VECTOR need to be defined according to Figure 13.8; IGB.EQ.1: trimming curve is defined in global coordinate system.

<b>VARIABLE</b>	<b>DESCRIPTION</b>
NSEED1/ NSEED2	A node ID on the blank in the area that remains after trimming, applicable to both options <b>_3D</b> or <b>_NEW</b> . LT.0: positive number is a node ID, which may not necessarily be from the blank. <b>See Remark 3.</b>
CX	x-coordinate of trim curve. Define if and only if TCTYPE=1.
CY	y-coordinate of trim curve. Define if and only if TCTYPE=1.
FILENAME	Name of IGES database containing trim curve(s). Define if and only if TCTYPE=2.

**Remarks:**

1. The option **\_NEW** activates a new searching algorithm, which enables a much faster trimming operation compared with option **\_3D**. For big models, the improvement in computational efficiency of the **\_NEW** option is significant. In addition, like the option **\_3D**, users are required to pick a seed node (or position coordinates). Also, **Remarks** in keyword **\*INTERFACE\_SPRINGBACK** provides some more details.
2. This command in combination with **\*ELEMENT\_TRIM** trims the requested parts before a job starts (pre-trimming), and can handle adaptive mesh. If the command **\*ELEMENT\_TRIM** does not exist the parts are trimmed after the job is terminated (post-trimming). The keyword **\*DEFINE\_CURVE\_TRIM** by itself cannot deal with an adaptive mesh. See the detailed procedure outlined in the Remarks in the Section **\*INTERFACE\_SPRINGBACK**.
3. With the frequent application of adaptive re-meshing, the seed node for trimming is often unknown until the draw forming is complete. With the negative NSEED option, an extra node can be created for the definition of the seed node. Since this node is not related to the blank and tools, the trimming process is no longer dependent on the previous process simulation results. The extra node can be defined using keyword **\*NODE**. A partial keyword input example for the trimming of a double-attached NUMISHEET2002 fender outer with option **\_NEW** is listed below, where a 2D trimming is performed with IGES file doubletrim.iges in the global Z-axis, with two nodes of negative ID 105226 and 18764 assigned to the variables NSEED1 and NSEED2, respectively. The two seed nodes are defined from the stationary lower post, as shown in the figures below.

```

*KEYWORD
*CONTROL_TERMINATION
0.000
*CONTROL_SHELL
.....
*CONTROL_OUTPUT
.....

```

```

*DATABASE_BINARY_D3PLOT
.....
*DATABASE_EXTENT_BINARY
.....
$---+---1---+---2---+---3---+---4---+---5---+---6---+---7---+---8
*SET_PART_LIST
.....
*PART
Blank
.....
*SECTION_SHELL
.....
*MAT_3-PARAMETER_BARLAT
.....
$---+---1---+---2---+---3---+---4---+---5---+---6---+---7---+---8
*INCLUDE_TRIM
drawn.dynain
*ELEMENT_TRIM
1
*DEFINE_CURVE_TRIM_NEW
$#   TCID   TCTYPE   TFLG   TDIR   TCTOL   TOLN   NSEED1   NSEED2
      1       2         0     0.250     1    -43356   -18764
doubletrim.iges
$---+---1---+---2---+---3---+---4---+---5---+---6---+---7---+---8
*NODE
18764,-184.565,84.755,78.392
43356,-1038.41,119.154,78.375
$ above nodes are from stationary punch mesh N18764 and N43356
*INTERFACE_SPRINGBACK_LSDYNA
.....
*END

```

If the seed node is too far away from the blank it will be projected to the blank and the new position will be used as the seed node. Typically, this node can be selected from the stationary tool in its home position.

Alternatively, if the variable NSEEDs are not defined, the seeds can be defined using **\*DEFINE\_TRIM\_SEED\_POINT\_COORDINATES**. A partial keyword input is provided below for trimming of the same double-attached fender outer.

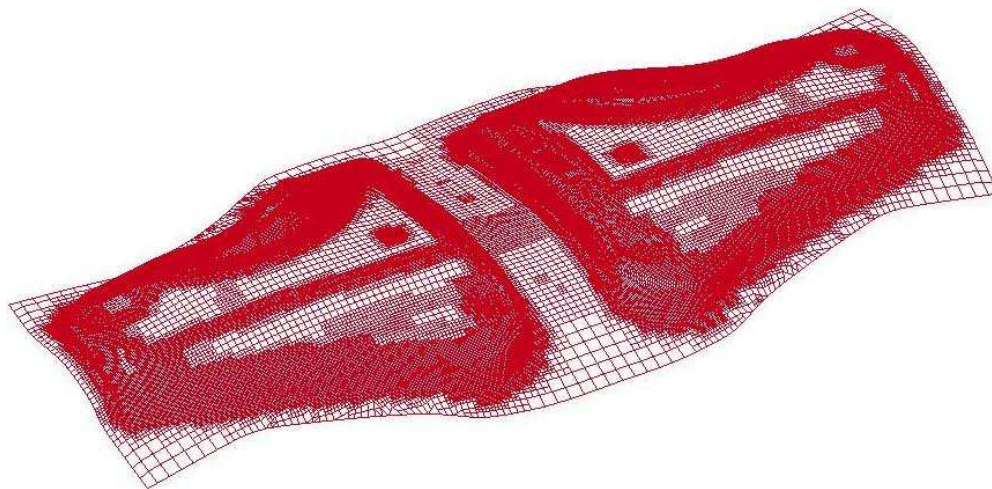
```

*INCLUDE_TRIM
drawn.dynain
*ELEMENT_TRIM
1
*DEFINE_CURVE_TRIM_NEW
$#   TCID   TCTYPE   TFLG   TDIR   TCTOL   TOLN   NSEED1   NSEED2
      1       2         0     0.250     1
doubletrim.iges
*DEFINE_TRIM_SEED_POINT_COORDINATES
$   NSEED     X1     Y1     Z1     X2     Y2     Z2
      2  -184.565   84.755   78.392  -1038.41  119.154  78.375

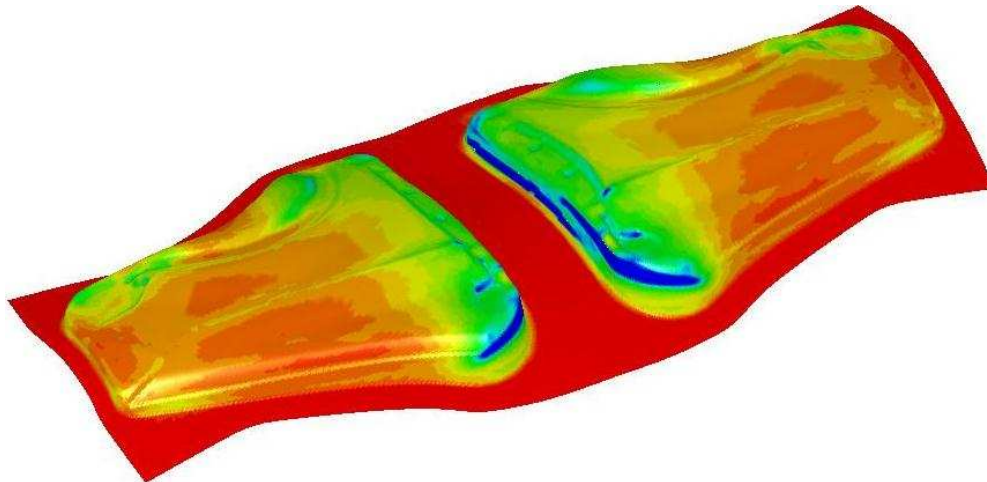
```



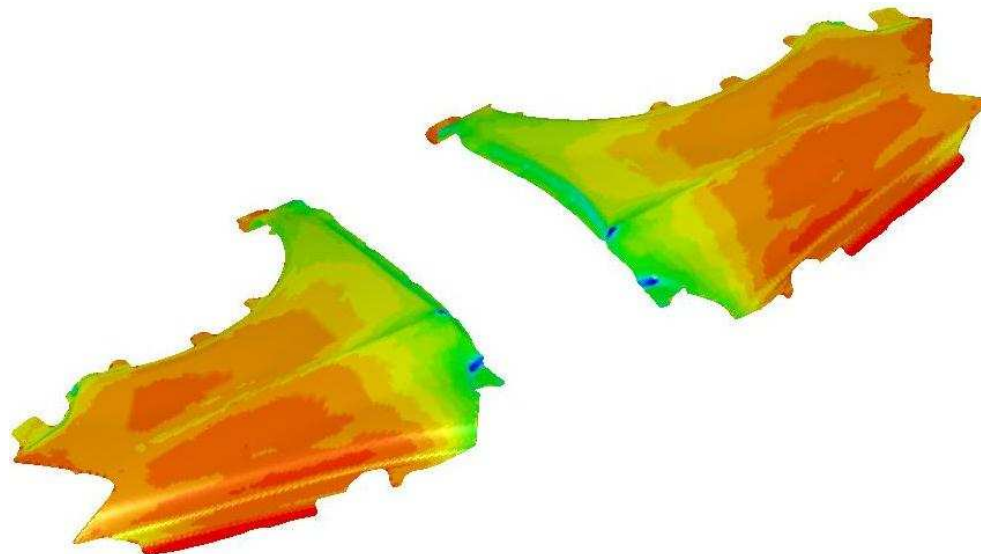
Using the two nodes from the stationary tools at its home position to define NSEED1 and NSEED2 for trimming of a double-attached part (NUMISHEET2002 Fender Outer)



A double-attached drawn part in wireframe mode



A double-attached drawn part (thickness/thinning plot)



A double-attached drawn part trimmed into two pieces with NSEED1/NSEED2 (thickness/thinning plot)

4. In case of big element size and complex trim curves, the blank mesh can be pre-adapted along the trim curves before trimming by adding the keyword `*CONTROL_ADAPTIVE_CURVE` to the above example for a better quality trim edge. The following indicates refine meshes for part set ID 1 no more than 4 levels along the trim curves, or until element size reaches 3.0:

```
*CONTROL_ADAPTIVE_CURVE
$#  IDSET  ITYPE  N      SMIN  ITRIOPT
      1      2      4      3.0   0
```

5. Sometimes it is helpful to conduct a check of the trimmed mesh along the edge in the same trimming input deck using `*CONTROL_CHECK_SHELL`. This is especially useful for the

next continued process simulation. For detailed usage, check for an updated **Remarks** for this keyword.

6. Enclosed trimming curves (same start and end points) are required for all options. Furthermore, for each enclosed trimming curve, one curve segment is required for option **\_3D**; while several curve segments are acceptable with option **\_NEW**.
7. The trimming tolerance TCTOL limits the size of the smallest element created during trimming. A value of 0.0 places no limit on element size. A value of 0.5 restricts new elements to be at least half of the size of the parent element. A value of 1.0 allows no new elements to be generated, only repositioning of existing nodes to lie on the trim curve. A negative tolerance value activates "simple" trimming, where entire elements are removed, leaving a jagged edge.

When TCTOL is used as a distance definition, and in conjunction with **\*CONTROL\_ADAPTIVE\_CURVE**, the mesh will be refined along both sides of the defined curve, limited within the distance specified. This is useful in line die simulation. This mesh refinement feature happens when **\*ELEMENT\_TRIM**, which must be defined for trimming, is absent from the input deck. To include a dynain file from the previous process simulation for this adaptive application, the keyword **\*INCLUDE** (not **\*INCLUDE\_TRIM**) is to be used. In addition, this feature works with option **\_3D**, and currently is a stand-alone process (cannot be combined with Forming, Trimming, etc.). A partial input example is listed below, where mesh will refine within a range of 4.0mm, formed by 2.0mm distance of both sides of the curve, defined by file "adpcurves.iges". The maximum refine level is 4 and minimum element size allowed is 0.3mm.

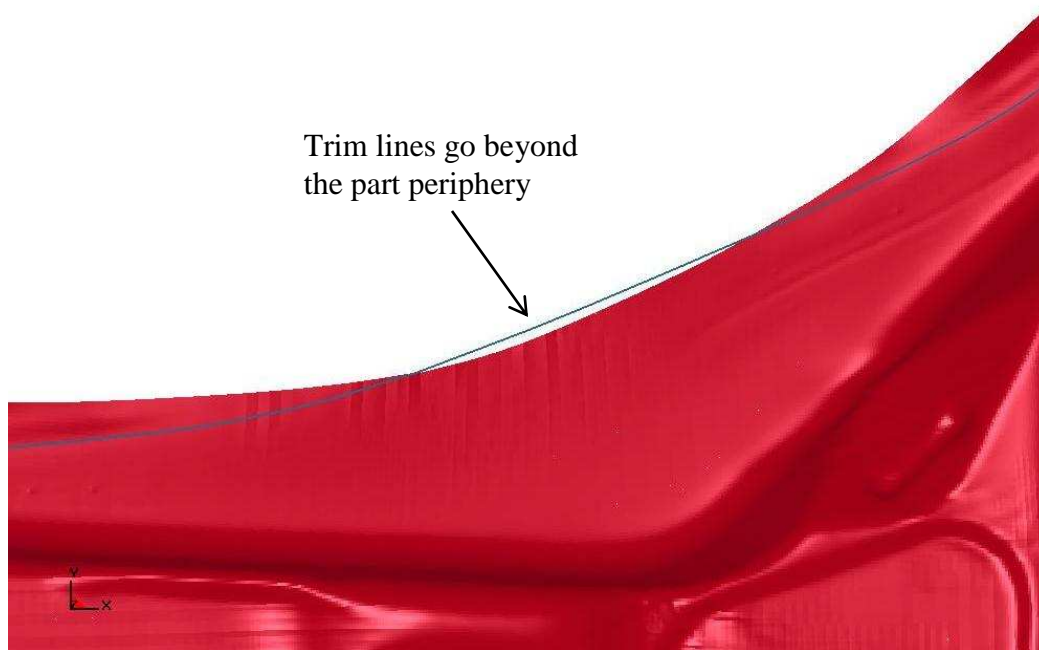
```
*INCLUDE
drawn.dynain
*DEFINE_CURVE_TRIM_3D
$   TCID   TCTYPE   TFLG   TDIR   TCTOL
      1       2       0       0     2.000
adpcurves.iges
*CONTROL_ADAPTIVE_CURVE
$   IDSET   ITYPE     N       SMIN
      1       2       4       0.3
```

Mesh refinement along a curve is very useful during line die simulation. For example, in a flanging simulation, trimmed blank, where it is flat in the flanging radius area, can be refined using a curve generated from the trim post radius. In LS-PrePost 3.2, the curve can be generated using Curve/Spline/From Mesh/By Edge, check Prop, and define a large Ang to create a continuous curve along element edge. This curve can then be projected onto the blank mesh using GeoTol/Project feature, to be used as the curve file "adpcurves.iges" here.

In the figures at the end of this keyword pages, this feature is demonstrated on two examples. In the fender outer example, the effect of TCTOL value is obvious. This feature offers better control on how many elements to be created for line die simulation, compared with the previous method as described in keyword **\*CONTROL\_ADAPTIVE\_CURVE** manual pages.

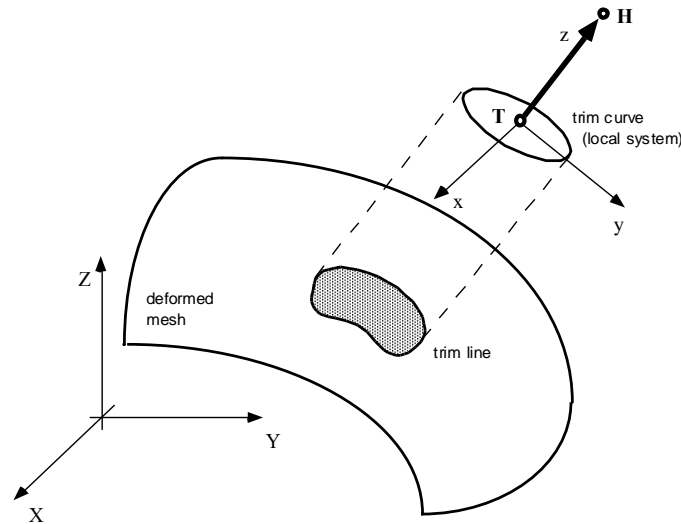


8. The keyword `*INCLUDE_TRIM` is recommended to be used at all times, instead of simply `*INCLUDE`, when a dynain file from the previous process is to be included, either for trimming or for mesh refinement purpose.
9. For option `_NEW`, R6 Revision 68643 and later releases enable trimming of a part where trim lines go beyond the part boundary. This is illustrated in the figure below.

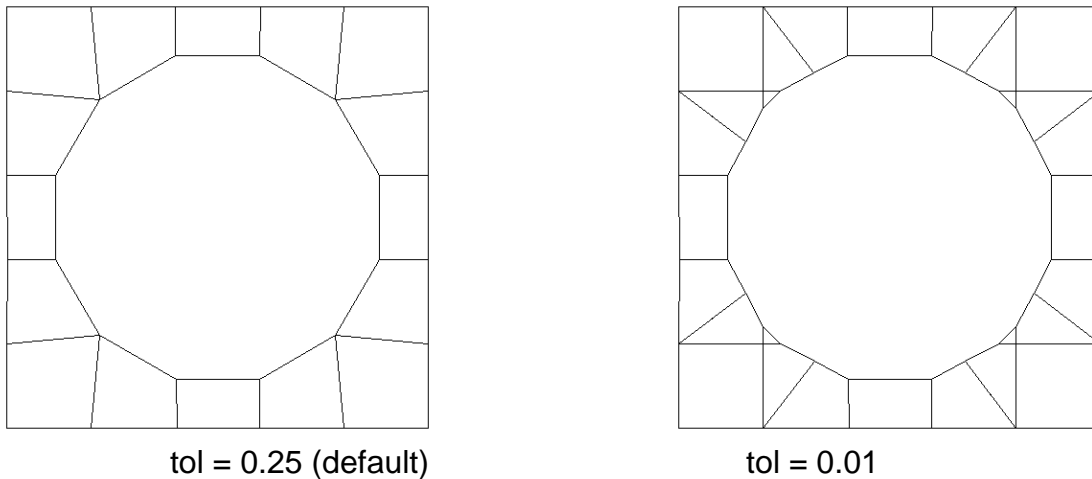


R6 Revision 68643 enables trimming for cases where trim lines go beyond part boundary

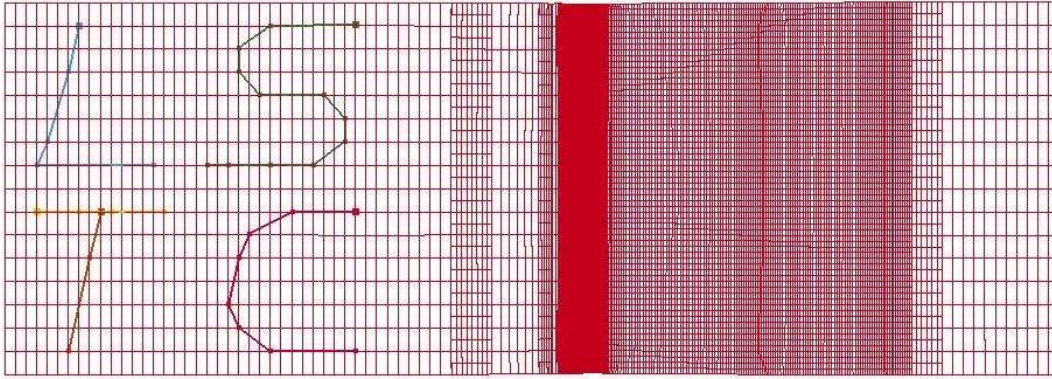
10. Negative seed node option is available in LS-DYNA R4 Revision 54608 and later releases, and in R4\_52312 and later releases, for options `_3D` and `_NEW`, respectively. Latest releases incorporate more improvements. The feature `TCTOL` as a distance for mesh refinement when used together with `*CONTROL_ADAPTIVE_CURVE` is available in R6 Revision 65630 and later releases.



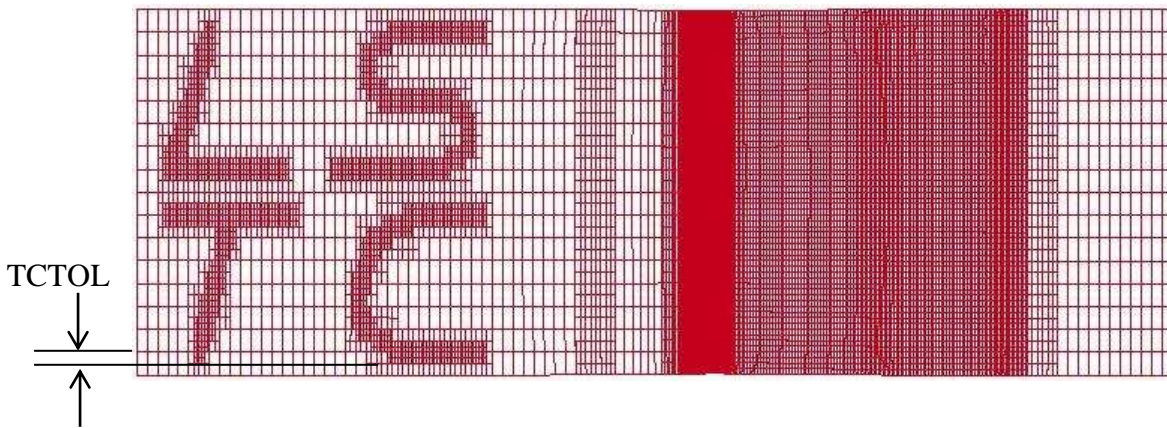
**Figure 13.8. Trimming Orientation Vector.** The tail (T) and head (H) points define a local coordinate system (x,y,z). The global coordinate system is named (X,Y,Z). The local x-direction is constructed in the Xz plane. If X and z nearly coincide ( $|X \cdot z| > 0.95$ ), then the local x-direction is instead constructed in the Yz plane. Trim curve data is input in the x-y plane, and projected in the z-direction onto the deformed mesh to obtain the trim line.



**Figure 13.9 Trimming Tolerance.** The tolerance limits the size of the small elements generated during trimming. The default tolerance (left) produces large elements. Using a tolerance of 0.01 (right) allows smaller elements, and more detail in the trim line.



Curves used for mesh refinement can be discontinuous and written in one IGES file.

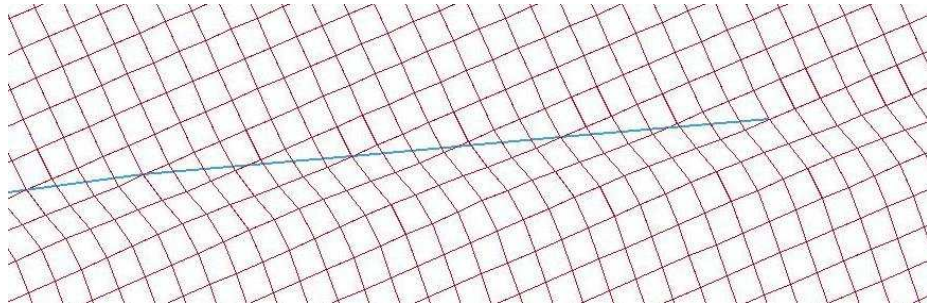


Define the variable TCTOL to limit the mesh adaptivity area.

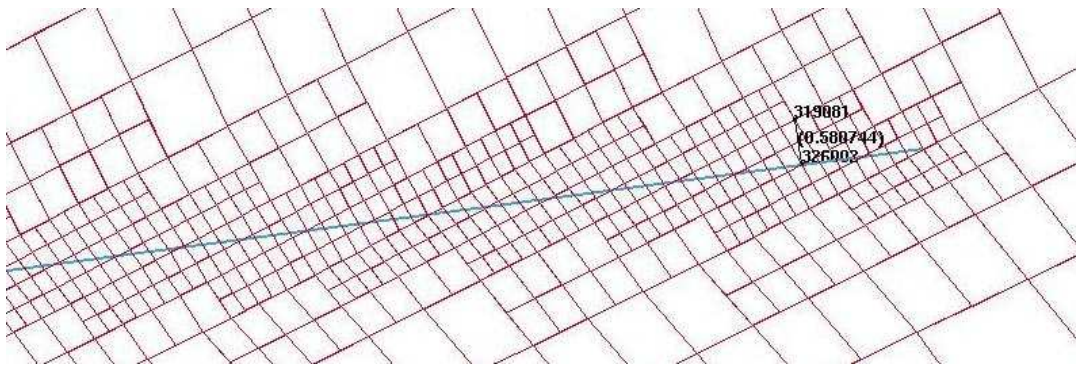


A more complex mesh refinement example (NUMISHEET2002 Fender)

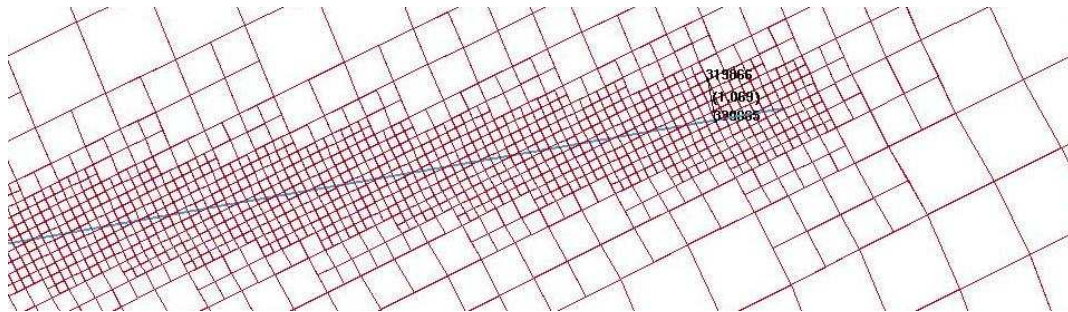




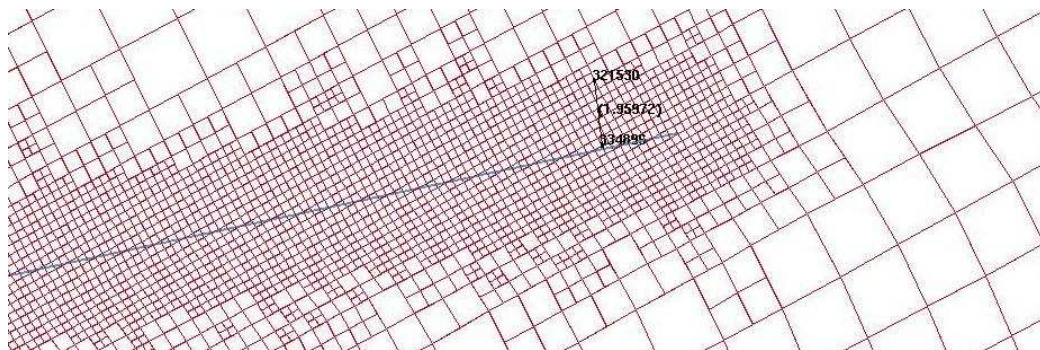
Original mesh with target curves defined.



Mesh refinement with TCTOL=0.5



Mesh refinement with TCTOL=1.0



Mesh refinement with TCTOL=2.0

**\*DEFINE\_DEATH\_TIMES\_OPTION**

Available options include:

**NODES**

**SET**

**RIGID**

Purpose: To dynamically define the death times for \*BOUNDARY\_PRESCRIBED\_MOTION based on the locations of nodes and rigid bodies. Once a node or rigid body moves past a plane or a geometric entity, the death time is set to the current time. The input in this section continues until the next ‘\*’ card is detected.

Card 1            1            2            3            4            5            6            7            8

Variable	GEO	N1	N2	N3				
Type	I	I	I	I				
Default		0	0	0				

Card 2            1            2            3            4            5            6            7            8

Variable	X_T	Y_T	Z_T	X_H	Y_H	Z_H	R	FLAG
Type	F	F	F	F	F	F	F	
Default								1

**Cards 3, ..., The next “\*” card terminates the friction definition.**

Card 3...      1            2            3            4            5            6            7            8

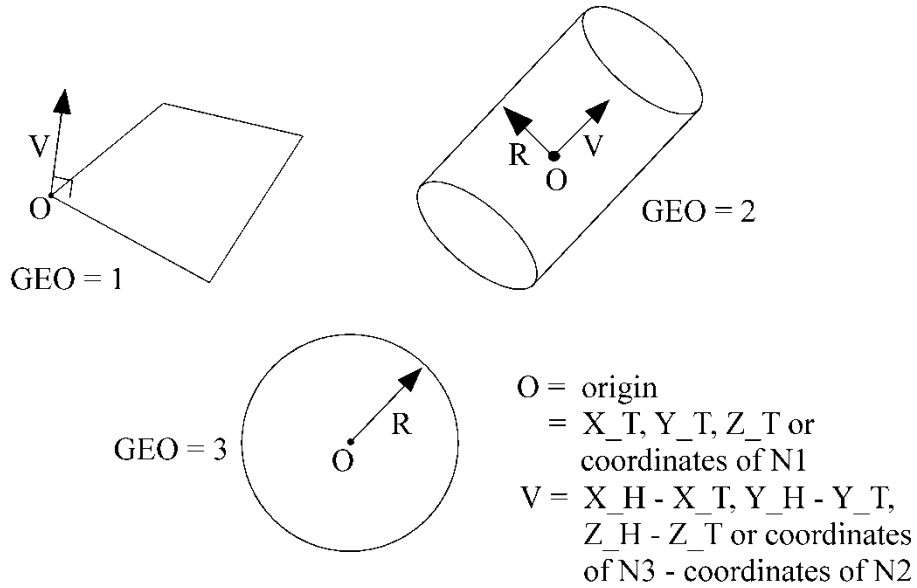
Variable	NSID1	NSID2	NSID3	NSID4	NSID5	NSID6	NSID7	NSID8
Type	I	I	I	I	I	I	I	I

<u>VARIABLE</u>	<u>DESCRIPTION</u>
GEO	Geometric entity type. =1 plane, =2 infinite cylinder, =3 sphere
N1	Node defining the origin of the geometric entity (optional).
N2	Node defining the tail of the orientation vector (optional).
N3	Node defining the head of the orientation vector (optional).
X_T	X coordinate of the origin of the geometric entity and the tail of the orientation vector.
Y_T	Y coordinate of the origin of the geometric entity and the tail of the orientation vector.
Z_T	Z coordinate of the origin of the geometric entity and the tail of the orientation vector.
X_H	X coordinate of the head of the orientation vector.
Y_H	Y coordinate of the head of the orientation vector.
Z_H	Z coordinate of the head of the orientation vector.
R	Radius of cylinder or sphere.
FLAG	+1 for killing motion when the node is outside of the geometric entity or on the positive side of the plane as defined by the normal direction, or -1 for the inside.
NSID <sub>i</sub>	i-th node, node set, or rigid body

**Remarks:**

1. Either N1 or X\_T, Y\_T, and Z\_T should be specified, but not both.

2. Either N2 and N3 or X\_H, Y\_H, and Z\_H should be specified, but not both. If N2 and N3. Specifying N2 and N3 is equivalent of setting the head of the vector equal to the tail of the vector (X\_T, Y\_T, and Z\_T) plus the vector from N2 to N3.



**Figure 13.10.**

# \*DEFINE

## \*DEFINE\_DE\_ACTIVE\_REGION

### \*DEFINE\_DE\_ACTIVE\_REGION

Purpose: To define an interested region for discrete elements (DE) for high efficiency collision pair searching. Any DE leaving this domain will not be considered in the future DE searching and also disabled in the contact algorithm.

Card 1            1            2            3            4            5            6            7            8

Variable	ID	TYPE	Xm	Ym	Zm			
Type	I	I	F	F	F			
Default	None	0	0.	0.	0.			

#### VARIABLE

#### DESCRIPTION

ID	Set ID/Box ID
TYPE	EQ.0: Part set ID 1: BOX ID
Xm, Ym, Zm	Factor for region's margin on each direction based on region length. The static coordinates limits are determined either by part set or box option. To extended those limits to provide a buffer zone, these factors can be used. The margin in each direction is calculated in the following way.  Limits for X-direction: Xmin, Xmax $DX = Xmax - Xmin$ $X\_margin = Xm * DX$  $Xmax = Xmax + X\_margin$ $Xmin = Xmin - X\_margin$



**\*DEFINE\_DE\_TO\_SURFACE\_COUPLING**

Purpose: To define coupling interface between DES and shell surface.

Card 1            1            2            3            4            5            6            7            8

Variable	SLAVE	MASTER	STYPE	MTYPE				
Type	I	I	I	I				
Default	0	0	0	0				

Card 2            1            2            3            4            5            6            7            8

Variable	FricS	FricD	DAMP	BSORT				
Type	F	F	F	I				
Default	0	0	0	100				

<u>VARIABLE</u>	<u>DESCRIPTION</u>
SLAVE	DES nodes
MASTER	Shell set
STYPE	EQ.0: Slave node set EQ.1: Slave node
MTYPE	EQ. 0: Part set EQ. 1: Part
FricS	Friction coefficient
FricD	Rolling friction coefficient
DAMP	Damping coefficient
BSORT	Number of cycle between bucket sort. (Default=100)

# \*DEFINE

# \*DEFINE\_ELEMENT\_DEATH

## \*DEFINE\_ELEMENT\_DEATH\_OPTION

Available options include:

**SOLID**

**SOLID\_SET**

**BEAM**

**BEAM\_SET**

**SHELL**

**SHELL\_SET**

**THICK\_SHELL**

**THICK\_SHELL\_SET**

Purpose: To define a discrete time or box to delete an element or element set during the simulation.

Card 1            1            2            3            4            5            6            7            8

Variable	EID/SID	TIME	BOXID	INOUT				
Type	I	I	I	I				
Default		0	0	0				

### VARIABLE

### DESCRIPTION

EID/SID	Element ID or element set ID.
TIME	Deletion time for elimination of the element or element set. If BOXID is nonzero, a TIME value of zero is reset to 1.0E+16.
BOXID	Element inside or outside of defined box are deleted depending on the value of INOUT.
INOUT	Location of deleted element: EQ.0: Elements inside box are deleted EQ.1: Element outside of box are deleted

**\*DEFINE\_ELEMENT\_GENERALIZED\_SHELL**

Purpose: Define a general 3D shell formulation to be used in combination with \*ELEMENT\_GENERALIZED\_SHELL. The objective of this feature is to allow the rapid prototyping of new shell element formulations by adding them through the keyword input file. All necessary information, like the values of the shape functions and their derivatives at various locations (at the integration points and at the nodal points) have to be defined via this keyword. An example for a 9-noded generalized shell element with 4 integration points in the plane is given in Figure 13.11 to illustrate the procedure. The element formulation ID ( $\rightarrow$  ELFORM) used in this keyword needs to be greater or equal than 1000 and will be referenced through \*SECTION\_SHELL (see Figure 16.2 in \*ELEMENT\_GENERALIZED\_SHELL).

Card 1            1            2            3            4            5            6            7            8

Variable	ELFORM	NGP	NMNP	IMASS	FORM			
Type	I	I	I	I	I			
Default	none	none	none	none	none			

**Block A:**

**Define for every (NGP) in-plane integration point i a block of  $NA=1+NMNP$  cards  $A_i$ . Card  $A_{i_1}$  specifies the integration weight of integration point i followed by  $NMNP$  cards ( $A_{i_2} \dots A_{i_{(NMNP+1)}}$ ) specifying the shape functions and their derivatives for all  $NMNP$  nodes k at the location of the integration point i. The total number of cards necessary in Block A is:  $NAT=NGP*(1+NMNP)$**

Card  $A_{i_1}$         1            2            3            4            5            6            7            8

Variable	WI							
Type	F							

Crds  $A_{i_1+k}$     1            2            3            4            5            6            7            8

Variable	NKI	DNKIDR	DNKIDS	
Type	F	F	F	

# \*DEFINE

## \*DEFINE\_ELEMENT\_GENERALIZED\_SHELL

### Block B:

The next block of data depends on the shell formulation specified by FORM in Card 1.

#### If FORM=0 or FORM=1:

Define for every (NMNP) node l NMNP cards Bk (Bk\_1 ... Bk\_l) specifying the shape function derivatives for all NMNP nodes k at the location of the node l. The number of cards necessary in Block B:  $NBT = NMNP * NMNP$

Cards Bl\_k      1            2            3            4            5            6            7            8

Variable	DNKLDR	DNKLDS		
Type	F	F		

#### If FORM=2 or FORM=3:

Define for every (NGP) in-plane integration point i NMNP cards Bk (Bk\_1 ... Bk\_l) specifying the second shape function derivatives for all NMNP nodes k at the location of the integration point i. The number of cards necessary in Block B:  $NBT = NGP * NMNP$

**Remark:** This requires that the shape functions are at least C1-continuous.

Cards Bi\_k      1            2            3            4            5            6            7            8

Variable	D2NKIDR2	D2NKIDRDS	D2NKIDS2	
Type	F	F	F	

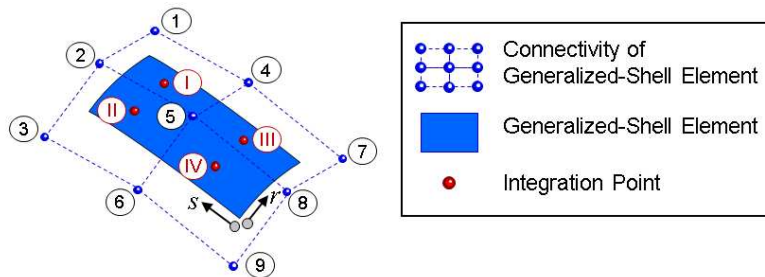
<u>VARIABLE</u>	<u>DESCRIPTION</u>
ELFORM	Element Formulation ID referenced via *SECTION_SHELL to connect *ELEMENT_GENERALIZED_SHELL with the appropriate shell formulation. The chosen number needs to be greater or equal than 1000.
NGP	Number of in-plane integration points.
NMNP	Number of nodes for this element formulation.
IMASS	Option for lumping of mass matrix: EQ.0: row sum EQ.1: diagonal weighting.
FORM	Shell formulation to be used EQ.0: shear deformable shell theory with rotational DOFs (shell normal evaluated at the nodes)

VARIABLE	DESCRIPTION
	EQ.1: shear deformable shell theory without rotational DOFs (shell normal evaluated at the nodes) EQ.2: thin shell theory without rotational DOFs (shell normal evaluated at the integration points) EQ.3: thin shell theory with rotational DOFs (shell normal evaluated at the integration points)
WI	Integration weight at integration point i.
NKI	Value of the shape function $N_k$ evaluated at integration point i.
DNKIDR	Value of the derivative of the shape function $N_k$ with respect to the local coordinate r at the integration point i $\left(\frac{\partial N_k^i}{\partial r}\right)$ .
DNKIDS	Value of the derivative of the shape function $N_k$ with respect to the local coordinate s at the integration point i $\left(\frac{\partial N_k^i}{\partial s}\right)$ .
DNKLDR	Value of the derivative of the shape function $N_k$ with respect to the local coordinate r at the nodal point l $\left(\frac{\partial N_k^l}{\partial r}\right)$ .
DNKLDS	Value of the derivative of the shape function $N_k$ with respect to the local coordinate s at the nodal point l $\left(\frac{\partial N_k^l}{\partial s}\right)$ .
D2NKIDR2	Value of the second derivative of the shape function $N_k$ with respect to the local coordinate r at the integration point i $\left(\frac{\partial^2 N_k^i}{\partial r^2}\right)$ .
D2NKIDRDS	Value of the second derivative of the shape function $N_k$ with respect to the local coordinates r and s at the integration point i $\left(\frac{\partial^2 N_k^i}{\partial r \partial s}\right)$ .
D2NKIDS2	Value of the second derivative of the shape function $N_k$ with respect to the local coordinate s at the integration point i $\left(\frac{\partial^2 N_k^i}{\partial s^2}\right)$ .

**Remarks:**

- For post-processing and the treatment of contact boundary conditions, the use of interpolation shell elements (see \*ELEMENT\_INTERPOLATION\_SHELL and \*CONSTRAINED\_NODE\_INTERPOLATION) is necessary.

- The order of how to put in the data for the NMNP nodal points has to be in correlation with the definition of the connectivity of the element in \*ELEMENT\_GENERALIZED\_SHELL.



```

*DEFINE_ELEMENT_GENERALIZED_SHELL
$--ELFORM-----+--NGP-----+--NMNP-----+IMASS-----+--FORM-----+6-----+7-----+8
      1001          4          9          0          1
W1
NMNP Lines {
  $ gauss point 1 (I=1)
  1.3778659577546E-04
  1.7098997698601E-01 3.3723996630918E+00 2.4666694616947E+00
  ...
W2
NMNP Lines {
  $ gauss point 2 (I=2)
  2.2045855324077E-04
  5.4296436772101E-02 1.9003752917745E+00 7.8327025592051E+00
  ...
1 (W3)+
NMNP Lines {
  $ gauss point 3 (I=3)
  ...
1 (W4)+
NMNP Lines {
  $ gauss point 4 (I=4)
  ...
NMNP Lines {
  $ node 1 (L=1)
  4.8275862102259E+00 3.5310344763662E+01
  ...
NMNP Lines {
  $ node 2 (L=2)
  2.4137931051130E+00 8.8275861909156E+00
  ...
[... ]
NMNP Lines {
  $ node 9 (L=9)
  ...
  
```

**Figure 13.11.** Example of a generalized shell formulation with \*DEFINE\_ELEMENT\_GENERALIZED\_SHELL

**\*DEFINE\_ELEMENT\_GENERALIZED\_SOLID**

Purpose: Define a general 3D solid formulation to be used in combination with \*ELEMENT\_GENERALIZED\_SOLID. The objective of this feature is to allow the rapid prototyping of new solid element formulations by adding them through the keyword input file. All necessary information, like the values of the shape functions and their derivatives at all integration points have to be defined via this keyword. An example for a 18-noded generalized solid element with 8 integration points is given in Figure 13.12 to illustrate the procedure. The element formulation ID ( $\rightarrow$  ELFORM) used in this keyword needs to be greater or equal than 1000 and will be referenced through \*SECTION\_SOLID (see Figure 16.3 in \*ELEMENT\_GENERALIZED\_SOLID).

**Card Format (8I10)**

Card 1            1            2            3            4            5            6            7            8

Variable	ELFORM	NGP	NMNP	IMASS				
Type	I	I	I	I				
Default	none	none	none	none				

**Block A:**

Define for every (NGP) integration point *i* a block of  $NA=1+NMNP$  cards  $A_i$ . Card  $A_{i_1}$  specifies the integration weight of integration point *i* followed by  $NMNP$  cards ( $A_{i_2} \dots A_{i_{(NMNP+1)}}$ ) specifying the shape functions and their derivatives for all  $NMNP$  nodes *k* at the location of the integration point *i*. The total number of cards necessary in Block A is:  $NAT=NGP*(1+NMNP)$

**Card Format (4E20.0)**

Card  $A_{i_1}$         1            2            3            4            5            6            7            8

Variable	WI							
Type	F							
Default	none							

# \*DEFINE

# \*DEFINE\_ELEMENT\_GENERALIZED\_SOLID

Crds Ai\_1+k      1            2            3            4            5            6            7            8

Variable	NKI	DNKIDR	DNKIDS	DNKIDT
Type	F	F	F	F
Default	none	none	none	none

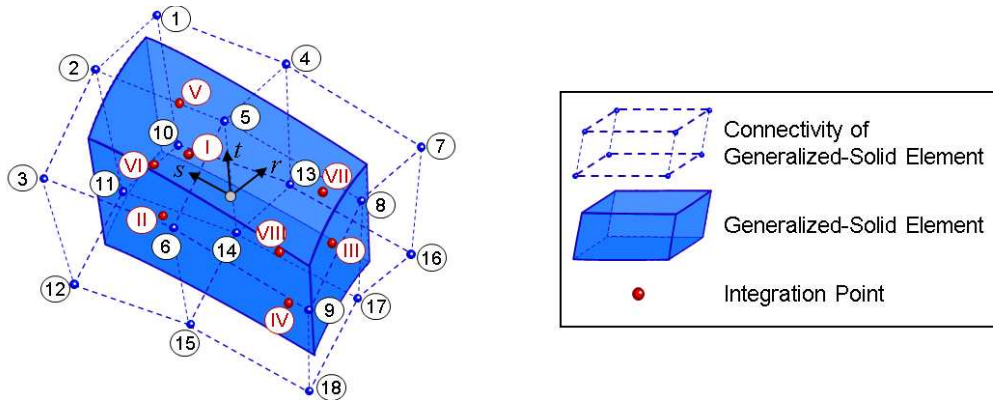
<u>VARIABLE</u>	<u>DESCRIPTION</u>
ELFORM	Element Formulation ID referenced via *SECTION_SOLID to connect *ELEMENT_GENERALIZED_SOLID with the appropriate solid formulation. The chosen number needs to be greater or equal than 1000.
NGP	Number of integration points.
NMNP	Number of nodes for this element formulation.
IMASS	Option for lumping of mass matrix: EQ.0: row sum EQ.1: diagonal weighting.
WI	Integration weight at integration point i.
NKI	Value of the shape function $N_k$ evaluated at integration point i.
DNKIDR	Value of the derivative of the shape function $N_k$ with respect to the local coordinate r at the integration point i $\left(\frac{\partial N_k^i}{\partial r}\right)$ .
DNKIDS	Value of the derivative of the shape function $N_k$ with respect to the local coordinate s at the integration point i $\left(\frac{\partial N_k^i}{\partial s}\right)$ .
DNKIDT	Value of the derivative of the shape function $N_k$ with respect to the local coordinate t at the integration point i $\left(\frac{\partial N_k^i}{\partial t}\right)$ .

## Remarks:

5. For post-processing the use of interpolation solid elements (see \*ELEMENT\_INTERPOLATION\_SOLID and \*CONSTRAINED\_NODE\_INTERPOLATION) is necessary.



- The order of how to put in the data for the NMNP nodal points has to be in correlation with the definition of the connectivity of the element in \*ELEMENT\_GENERALIZED\_SOLID.



```

*DEFINE_ELEMENT_GENERALIZED_SOLID
$---ELFORM-----+---NGP-----+---NMNP-----+IMASS-----+---5-----+---6-----+---7-----+---8
      1001           8           18           0

$ gauss point 1 (I=1)
$-----+-----W1
W1      1.3778659577546E-04
$-----+-----NKI-----+-----DNKIDR-----+-----DNKIDS-----+-----DNKIDT
NMNP    1.7098997698601E-01  3.3723996630918E+00  2.4666694616947E+00  1.5327451653258E+00
Lines   ...
$ gauss point 2 (I=2)
W2      2.2045855324077E-04
NMNP    5.4296436772101E-02  1.9003752917745E+00  7.8327025592051E+00  3.258715871621E+00
Lines   ...
[... ]
$ gauss point 8 (I=8)
NMNP    3.8574962585875E-04
Lines   2.6578426581235E-01  1.6258741125438E+00  2.9876495873627E+00  5.403982758392E+00
        ...
    
```

**Block A**

**Figure 13.12.** Example of a generalized solid formulation with \*DEFINE\_ELEMENT\_GENERALIZED\_SOLID

# \*DEFINE

# \*DEFINE\_FILTER

## \*DEFINE\_FILTER

Purpose: Define a general purpose filter, currently used by this option:

SENSOR\_SWITCH,

The input in this section consists of two cards:

Card 1            1            2            3            4            5            6            7            8

Variable	ID	Title						
Type	I	A70						

Card 2...        1            2            3            4            5            6            7            8

Type	Type	Data1	Data2	Data3	Data4	Data5	Data6	Data7
Type	A10							

### VARIABLE

### DESCRIPTION

ID	Identification number.
Title	Title for this filter.
Type	One of the 3 currently defined filter types: DISCRETE, CONTINUOUS, or CHAIN
Data1-7	Filter type specific data, which determines what the filter does.

### Remarks:

There are currently 3 types of filters available. The data and behavior of each is as follows:

**DISCRETE:**            The discrete filter operates on a fixed number of values of the input data. The first data field is an A10 character field, which gives the type of operation the filter performs: MIN, MAX, and AVG are the available options. The second data field is an I10 field, giving the number of

input values over which the minimum, maximum, or average is computed.

**CONTINUOUS:** Similar to the DISCRETE filter, except that it operates over a fixed time interval. The first data field is exactly the same as for the DISCRETE option. The second data field is an F10 field, indicating the duration of the filter. For example, if AVG is given, and the duration is set to 0.1, a running timestep weighted average is computed over the last 0.1 time of the simulation.

**CHAIN:** Here, data fields 1-7 are all I10 fields, and give the IDs of a list of other filters (including other CHAIN filters, if desired), each of which will be applied in order. So the raw data is fed to the filter indicated by Data1. The output of that is fed to the next filter, and so on, with up to 7 filters in the chain. List only as many filters as you need.

# \*DEFINE

## \*DEFINE\_FORMING\_BLANKMESH

### \*DEFINE\_FORMING\_BLANKMESH

Purpose: This keyword, together with keyword \*ELEMENT\_BLANKING, enable mesh generation for a sheet metal blank. This keyword is renamed from the previous keyword \*CONTROL\_FORMING\_BLANKMESH. The keyword \*DEFINE\_CURVE\_TRIM\_NEW can be coupled with this keyword to define a blank with a complex periphery and a number of inner hole cutouts.

Card 1            1            2            3            4            5            6            7            8

Variable	IDMSH	ELENG	XLENG	YLENG	ANGLEX	NPLANE	CID	
Type	I	F	F	F	F	I	I	
Default	none	0.0	0.0	0.0	0.0	1	0	

Card 2            1            2            3            4            5            6            7            8

Variable	PIDBK	NID	EID	XCENT	YCENT	ZCENT	XSHIFT	YSHIFT
Type	I	I	I	F	F	F	F	F
Default	1	1	1	0.0	0.0	0.0	0.0	0.0

#### VARIABLE

#### DESCRIPTION

IDMSH	ID of the blankmesh (not the blank PID); must be unique.
ELENG	Element edge length.
XLENG	Length of the rectangular blank along X-axis in the coordinate system (CID) defined.
YLENG	Length of the rectangular blank along Y-axis in the coordinate system (CID) defined.
ANGLEX	An angle defined about Z-axis of the CID specified, starting from the X-axis as the zero degree, to rotate the blank and the orientation of the mesh to be generated. The sign of the rotation angle follows the right hand rule. See <b>Remark 3</b> .

---

<u>VARIABLE</u>	<u>DESCRIPTION</u>
NPLANE	Plane in which a flat blank to be generated, in reference to the coordinate system defined (CID): EQ.0 or 1: XY-plane (default) EQ.2: XZ-plane EQ.3: YZ-plane
CID	ID of the local coordinate system, defined by *DEFINE_COORDINATE_SYSTEM. Default is 0 representing global coordinate system.
PIDBK	Part ID of the blank, as defined by *PART.
NID	Starting node ID of the blank to be generated.
EID	Starting element ID of the blank to be generated.
XCENT	X-coordinate of the center of the blank.
YCENT	Y-coordinate of the center of the blank.
ZCENT	Z-coordinate of the center of the blank.
XSHIFT	Blank shifting distance in X-axis in coordinate system defined (CID).
YSHIFT	Blank shifting distance in Y-axis in coordinate system defined (CID).

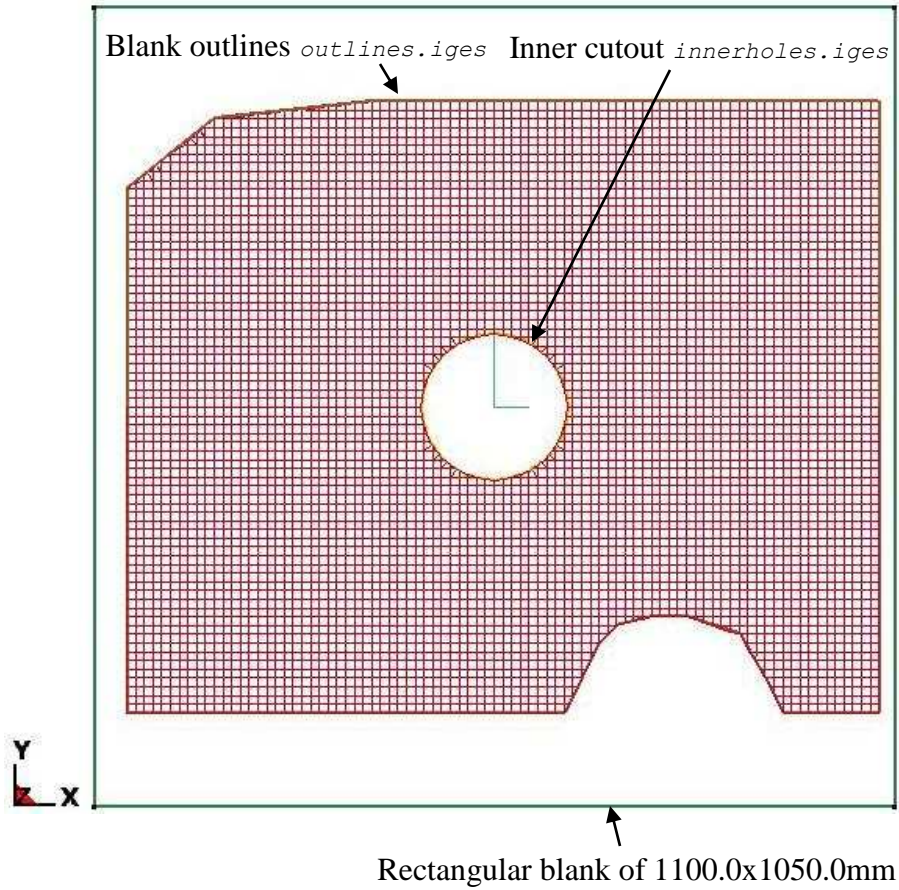
**Remarks:**

1. A rectangular blank is defined, which can be trimmed with IGES curves to a desired periphery and inner cutouts. This keyword is used in conjunction with keyword \*ELEMENT\_BLANKING. The blank outlines and inner holes can be defined using keyword \*DEFINE\_CURVE\_TRIM\_NEW.
2. A partial keyword example of generating a flat blank with PID 1 is provided below. In this example, the blank mesh is to be generated in XY plane in a global coordinate system, with an average element edge length of 12 mm and a blank dimension of 1100.0 x 1050.0 mm, with node and element ID starting at 8000, and with the center of the blank in the global origin. The blank is to be trimmed out with an inner cut-out hole, given by the IGES file *innerholes.iges*. Blank outer line is defined with an IGES file *outerlines.iges*. Both IGES files are used to trim the rectangular blank using keyword \*DEFINE\_CURVE\_TRIM\_NEW, where the variable TFLG is used to indicate whether it is an inside or outside trim. The blank generated for example is shown in the figure below.

# \*DEFINE

# \*DEFINE\_FORMING\_BLANKMESH

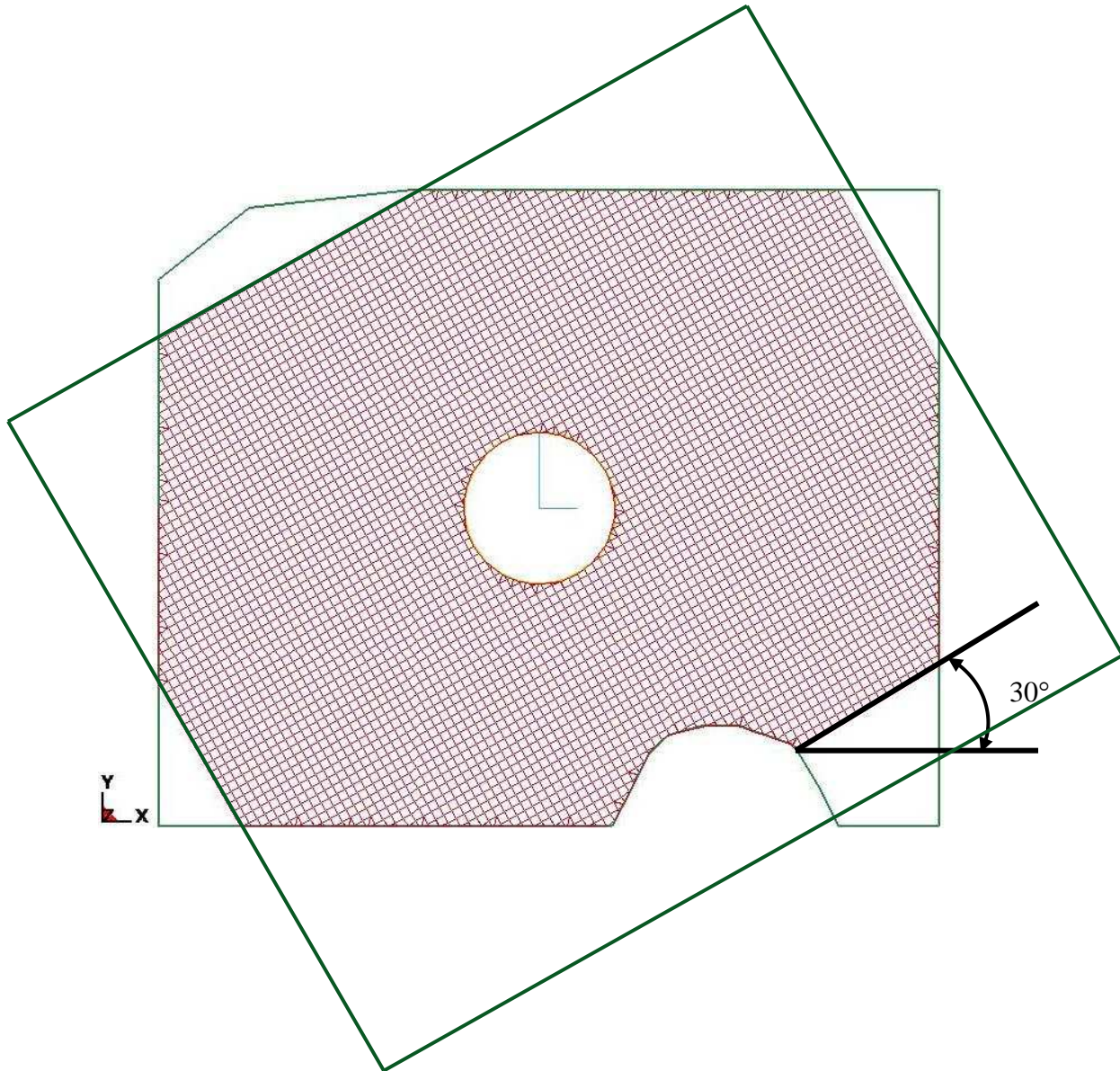
```
*KEYWORD
$---+---1---+---2---+---3---+---4---+---5---+---6---+---7---+---8
*CONTROL_TERMINATION
$#  endtim
    0.000
*CONTROL_FORMING_BLANKMESH
$   IDMSH      ELENG      XLENG      YLENG      ANGLEX      NPLANE      CID
    3         12.00     1100.00    895.0      0.0         0          0
$   PIDBK      NID        EID        XCENT      YCENT      ZCENT      XSHIFT     YSHIFT
    1         8000      8000
*ELEMENT_BLANKING
$#   psid
    1
*DEFINE_CURVE_TRIM_NEW
$#   tcid      tctype      TFLG      TDIR      TCTOL      TOLN      NSEED1     NSEED2
    1111       2          1         0      0.250000   1.000000
innerholes.iges
*DEFINE_CURVE_TRIM_NEW
$#   tcid      tctype      TFLG      TDIR      TCTOL      TOLN      NSEED1     NSEED2
    1112       2         -1         0      0.250000   1.000000
outerlines.iges
*CONTROL_SHELL
.....
*CONTROL_SOLUTION
.....
*DATABASE_BINARY_D3PLOT
.....
*DATABASE_EXTENT_BINARY
.....
*SET_PART_list
1
1
*PART
Blank
$#   pid      secid      mid
    1         1         1
*SECTION_SHELL
$#   secid     elform      shrf      nip      propt     qr/irid     icomp     setyp
    1         16     0.833000     7         1         0         0         0
$#   t1        t2        t3        t4        nloc      marea      idof      edgset
    1.500000   1.500000   1.500000   1.500000   0.000     0.000     0.000     0
*MAT_037
$#   mid      ro        e        pr      sigy      etan      r        hlcid
    1 7.9000E-9 2.0700E+5 0.300000 253.25900 0.000     1.408000 90903
*DEFINE_CURVE
    90903
0.0 253.2590027
.....
    0.9898300      616.7999878
*INTERFACE_SPRINGBACK_LSDYNA
$#   psid      nshv
    1         1000
*END
```



Using an IGES outline and an inner cutout curve to create a blank with any arbitrary shape

3. The blank and mesh orientation can be rotated about Z-axis defined. Following the right hand rule, the blank in this case is rotated about Z-axis for a positive 30°, as shown in the picture below, with the angle of 0° aligned with X-axis.





Set ANGLEX= 30.0 to rotate both the blank and mesh orientation by 30 °

4. Inner hole and outer periphery can also be trimmed using the NSEEDs variables in keyword \*DEFINE\_CURVE\_TRIM\_NEW.
5. This feature is available in LS-DYNA R5 Revision 59165 or later releases. The keyword name change from \*CONTROL... to \*DEFINE... starts in R6 Revision 69074 and later releases. For NPLANE in global coordinate system, use R6 Revision 69128 and later releases.



**\*DEFINE\_FRICTION**

Purpose: Define friction coefficients between parts for use in the contact options:

- SINGLE\_SURFACE,
- AUTOMATIC\_GENERAL,
- AUTOMATIC\_SINGLE\_SURFACE,
- AUTOMATIC\_NODES\_TO\_SURFACE,
- AUTOMATIC\_SURFACE\_TO\_SURFACE,
- AUTOMATIC\_ONE\_WAY\_SURFACE\_TO\_SURFACE,
- ERODING\_SINGLE\_SURFACE.

The input in this section continues until then next “\*” card is encountered. Default friction values are used for any part ID pair that is not defined. If FS=-2.0, this table will override the coefficients defined in \*PART\_CONTACT, which is activated by setting FS=-1.0. If only one friction table is defined, the only table is used for all contacts and no definition of FD, the dynamic coefficient of friction in \*CONTACT, is needed. If more than one friction table is defined, the table ID to be used in each contact has to be specified by FD.

Card 1            1            2            3            4            5            6            7            8

Variable	ID	FS_D	FD_D	DC_D	VC_D			
Type	I	F	F	F	F			
Default	0	0.0	0.0	0.0	0.0			

**Cards 2, 3, ..., The next “\*” card terminates the friction definition.**

Card 2...        1            2            3            4            5            6            7            8

Variable	PID_I	PID_J	FS_IJ	FD_IJ	DC_IJ	VC_IJ	PTYPEI	PTYPEJ
Type	I	I	F	F	F	F	A	A
Default			0.0	0.0	0.0	0.0		

<u>VARIABLE</u>	<u>DESCRIPTION</u>
-----------------	--------------------

ID	Identification number. Only one table is allowed.
----	---

<b>VARIABLE</b>	<b>DESCRIPTION</b>
FS_D	Default value of the static coefficient of friction. The frictional coefficient is assumed to be dependent on the relative velocity $v_{rel}$ of the surfaces in contact $\mu_c = FD + (FS - FD)e^{-DC v_{rel} }$ . Default values are used when part pair are undefined.
FD_D	Default value of the dynamic coefficient of friction. The frictional coefficient is assumed to be dependent on the relative velocity $v_{rel}$ of the surfaces in contact $\mu_c = FD + (FS - FD)e^{-DC v_{rel} }$ . Default values are used when part pair are undefined.
DC_D	Default value of the exponential decay coefficient. The frictional coefficient is assumed to be dependent on the relative velocity $v_{rel}$ of the surfaces in contact $\mu_c = FD + (FS - FD)e^{-DC v_{rel} }$ . Default values are used when part pair are undefined.
VC_D	Default value of the coefficient for viscous friction. This is necessary to limit the friction force to a maximum. A limiting force is computed $F_{lim} = VC \cdot A_{cont}$ . $A_{cont}$ being the area of the segment contacted by the node in contact. The suggested value for VC is to use the yield stress in shear $VC = \frac{\sigma_o}{\sqrt{3}}$ where $\sigma_o$ is the yield stress of the contacted material. Default values are used when part pair are undefined.
PID_I	Part, or part set, ID I.
PID_J	Part, or part set, ID J.
FS_IJ	Static coefficient of friction between parts I and J.
FD_IJ	Dynamic coefficient of friction between parts I and J.
DC_IJ	Exponential decay coefficient between parts I and J.
VC_IJ	Viscous friction between parts I and J.
PTYPEI, PTYPEJ	EQ: 'PSET' when PTYPEI or PTYPEJ refers to a set_part.

**\*DEFINE\_FRICTION\_ORIENTATION**

Purpose: This keyword allows for definition of different coefficients of friction (COF) in specific directions, specified using a vector and angles in degree. In addition, COF can be scaled according to the amount of pressure generated in the contact interface.

Card 1            1            2            3            4            5            6            7            8

Variable	PID	LCID	LCIDP	V1	V2	V3		
Type	I	I	I	F	F	F		
Default	none	0	0	0.0	0.0	0.0		

**VARIABLE****DESCRIPTION**

PID	Part ID to which directional and pressure-sensitive COF is to be applied. See *PART.
LCID	ID of the load curve defining COF vs. orientation in degree.
LCIDP	ID of the load curve defining COF scale factor vs. pressure.
V1	Vector components of vector V defining zero-degree (rolling) direction.
V2	Vector components of vector V defining zero-degree (rolling) direction.
V3	Vector components of vector V defining zero-degree (rolling) direction.

**Remarks:**

1. Load curves LCID and LCIDP are not extrapolated beyond what are defined. It is recommended that the definition is specified for the complete range of angle and pressure expected.
2. One edge of all elements on the sheet metal blank must align initially with the vector defined by V1, V2, and V3.
3. The following is a partial keyword input of using this feature to define directional frictions and pressure-sensitive COF scale factor.



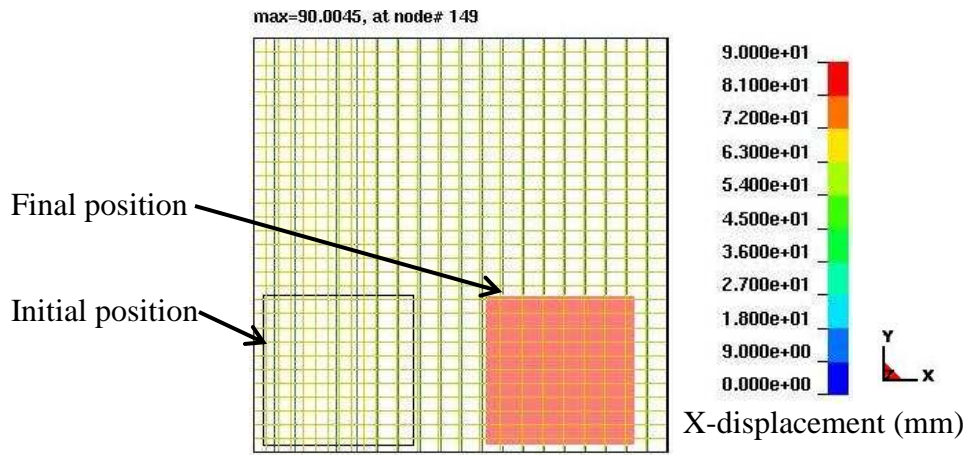


Figure 13.14 Deformed shape.

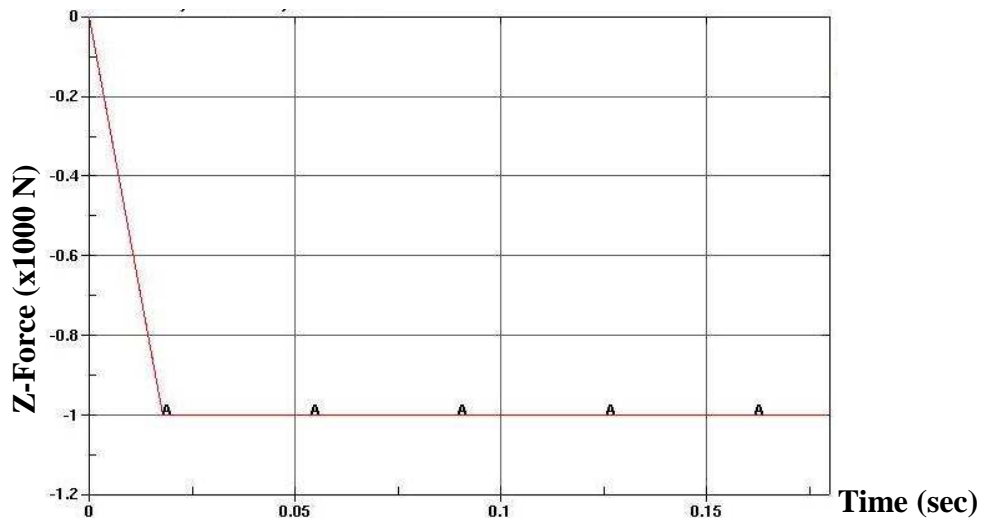
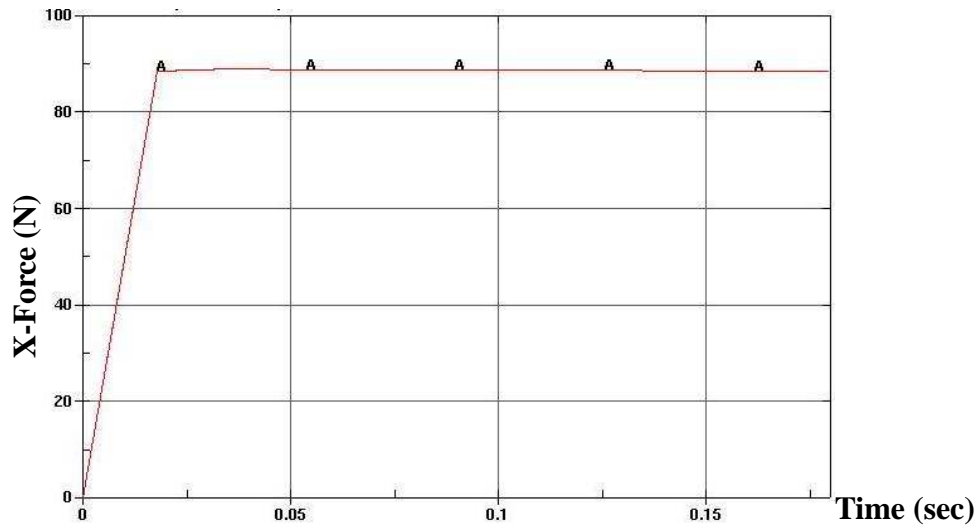


Figure 13.15. Normal force from RCFORC file.



**Figure 13.16** Pulling force (frictional force) from RCFORC file.







---

<u>VARIABLE</u>	<u>DESCRIPTION</u>
A1, A2,...	Abscissa values. Only pairs have to be defined, see remarks below.
O1, O2,...	Ordinate (function) values. Only pairs have to be defined, see remarks below.

**Example:**

```
*BOUNDARY_PRESCRIBED_MOTION_SET
$ function 300 prescribes z-acceleration of node set 1000
1000,3,1,300
*DEFINE_FUNCTION_TABULATED
201
tabfunc
0., 200
0.03, 2000.
1.0, 2000.
*DEFINE_FUNCTION
300
a(t)=tabfunc(t)*t
$$ following function is equivalent to one above
$ a(t)=(200. + 60000.*t)*t
```

**\*DEFINE\_GROUND\_MOTION**

Purpose: Define an earthquake ground motion history using ground motion records provided as load curves, for use in conjunction with \*LOAD\_SEISMIC\_SSI for dynamic earthquake analysis including nonlinear soil-structure interaction.

Card 1                    1                    2                    3                    4                    5                    6                    7                    8

Variable	GMID	ALCID	VLCID						
Type	I	I	I						
Default	none	none	0						

**VARIABLE****DESCRIPTION**

GMID	Ground motion ID. A unique number has to be defined.
ALCID	Load curve ID of ground acceleration history.
VLCID	Load curve ID of ground velocity history.

**Remarks:**

1. Earthquake ground motion data is typically available either only as ground accelerations, or as a triple of ground accelerations, velocities and displacements. Usually, the velocities and the displacements are computed from the accelerations using specialized filtering and baseline correction techniques, e.g. see [peer.berkeley.edu/smcat/process.html](http://peer.berkeley.edu/smcat/process.html). Either input is accepted, with each quantity specified as a load curve. Only the acceleration and the velocity is required in the latter case; LS-DYNA does not require the ground displacement.
2. If only the ground acceleration data is provided for a particular ground motion, LS-DYNA generates a corresponding load curve for the velocity by integrating the acceleration numerically. The generated load curves are printed out to the D3HSP file. It is up to the user to ensure that these generated load curves are satisfactory for the analysis.

**\*DEFINE\_HEX\_SPOTWELD\_ASSEMBLY\_{OPTION}**

Available options include the number of solid hexahedron elements that are used in the spot weld patch:

**<BLANK>**

**N**

Purpose: Define a list of hexahedral solid elements clusters that make up a single spot weld for computing the force and moment resultants that are written into the SWFORC output file. A maximum of a 16 element cluster may be used to define a single spot weld. See Fig. 13.17. This table is generated automatically when beam elements are converted to solid elements. See the input parameter, RPBHX, which is described in the control section: \*CONTROL\_SPOTWELD\_BEAM.

Card 1            1            2            3            4            5            6            7            8

Variable	ID_SW								
Type	I								
Default	0								

Card 2            1            2            3            4            5            6            7            8

Variable	EID1	EID2	EID3	EID4	EID5	EID6	EID7	EID8
Type	I	I	I	I	I	I	I	I
Default	0	0	0	0	0	0	0	0

# \*DEFINE

# \*DEFINE\_HEX\_SPOTWELD\_ASSEMBLY

Define the following card if and only if N>8

Optional      1            2            3            4            5            6            7            8

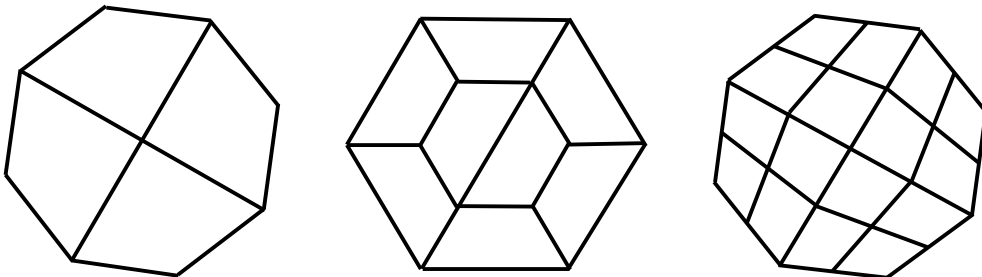
Variable	EID9	EID10	EID11	EID12	EID13	EID14	EID15	EID16
Type	I	I	I	I	I	I	I	I
Default	0	0	0	0	0	0	0	0

## VARIABLE

## DESCRIPTION

ID\_SW            Spot weld ID. A unique ID number must be used.

EIDn             Element ID n for up to 16 solid hexahedron elements.



**Figure 13.17.** Sample four, eight, and sixteen element spot weld clusters comprised of solid hexahedron elements.

**\*DEFINE\_MULTI\_DRAWBEADS\_IGES**

Purpose: This keyword is developed to simplify the draw beads definition and creation.

Card 1            1            2            3            4            5            6            7            8

Variable	FILENAME							
Type	C							
Default	none							

Card 2            1            2            3            4            5            6            7            8

Variable	DBID	VID	PID	BLKID	NCUR			
Type	I	I	I	I	I			
Default	none	none	1	1	none			

**Define card 2, 3, 4, etc. for multiple draw bead curves. Input is terminated when a “\*” is found.**

Card 3            1            2            3            4            5            6            7            8

Variable	CRVID	BFORCE						
Type	I	F						
Default	none	0.0						

**VARIABLE**

**DESCRIPTION**

DBID

Draw bead set ID, which may consists many draw bead segments.

<b>VARIABLE</b>	<b>DESCRIPTION</b>
VID	Vector ID, as defined by *DEFINE_VECTOR. This vector is used to project the supplied curves to the rigid tool, defined by variable PID.
PID	Part ID of the rigid tool to which the curves are projected and attached.
BLKID	Part set ID of the blank.
NCUR	Number of draw bead curve segments (in the IGES file) to be defined.
CVRID	IGES curve ID for each segment.
BFORCE	Draw bead force for each segment.

**Remarks:**

1. This keyword alone can be used to define draw bead forces around a stamping part. The following partial keyword example shows a draw bead set with ID 98, consists of three curves with ID, 12, 23, and 45, each with bead forces of 102.1, 203.3, 142.5 Newton, respectively, are being created for blank with PID 1, and are projected and attached to rigid tool with PID 3, along vector ID 99. The IGES file to be read is "drawbeads3.iges".

```
*DEFINE_MULTI_DRAWBEADS_IGES
drawbead3.iges
$      CID      VID      PID      BLKID      NCUR
      98      99      3      1      3
$      CID      BFORCE
      12      102.1
      23      203.3
      45      142.5
*define_vector
99,0.0,0.0,0.0,0.0,0.0,1.0
```

2. This feature is available in LS-DYNA R5 Revision 62840 and later releases.

**\*DEFINE\_SD\_ORIENTATION**

Purpose: Define orientation vectors for discrete springs and dampers. These orientation vectors are optional for this element class. Four alternative options are possible. With the first two options, IOP= 0 or 1, the vector is defined by coordinates and is fixed permanently in space. The third and fourth option orients the vector based on the motion of two nodes, so that the direction can change as the line defined by the nodes rotates.

Card            1            2            3            4            5            6            7            8

Variable	VID	IOP	XT	YT	ZT	NID1	NID2	
Type	I	I	F	F	F	I	I	
Default	0	0	0.0	0.0	0.0	0	0	
Remarks	none	1	IOP=0,1	IOP=0,1	IOP=0,1	IOP=2,3	IOP=2,3	

<u>VARIABLE</u>	<u>DESCRIPTION</u>
VID	Orientation vector ID. A unique ID number must be used.
IOP	Option: EQ.0: deflections/rotations are measured and forces/moments applied along the following orientation vector. EQ.1: deflections/rotations are measured and forces/moments applied along the axis between the two spring/damper nodes projected onto the plane normal to the following orientation vector. EQ.2: deflections/rotations are measured and forces/moments applied along a vector defined by the following two nodes. EQ.3: deflections/rotations are measured and forces/moments applied along the axis between the two spring/damper nodes projected onto the plane normal to the a vector defined by the following two nodes.
XT	x-value of orientation vector. Define if IOP=0,1.
YT	y-value of orientation vector. Define if IOP=0,1.
ZT	z-value of orientation vector. Define if IOP=0,1.
NID1	Node 1 ID. Define if IOP=2,3.
NID2	Node 2 ID. Define if IOP=2, 3.

**Remarks:**

1. The orientation vectors defined by options 0 and 1 are fixed in space for the duration of the simulation. Options 2 and 3 allow the orientation vector to change with the motion of the nodes. Generally, the nodes should be members of rigid bodies, but this is not mandatory. When using nodes of deformable parts to define the orientation vector, care must be taken to ensure that these nodes will not move past each other. If this happens, the direction of the orientation vector will immediately change with the result that initiate severe instabilities can develop.



**\*DEFINE\_SET\_ADAPTIVE**

Purpose: To control the adaptive refinement level by element or part set.

Card 1            1            2            3            4            5            6            7            8

Variable	SETID	STYPE	ADPLVL	ADPSIZE				
Type	I	I	I	F				
Default	none	none	none	none				

<u>VARIABLE</u>	<u>DESCRIPTION</u>
SETID	Element set ID or part set ID
STYPE	Set type for SETID: 1-element set 2-part set
ADPLVL	Adaptive refinement level for all elements in SETID set.
ADSIZE	Minimum element size to be adapted based on element edge length for all elements in SETID set.

**Remarks:**

1. This option is for 3D-shell h-adaptivity only at the present time.
2. The order of defining refinement level for any elements is \*CONTROL\_ADAPTIVITY and \*DEFINE\_BOX\_ADAPTIVE.
3. If there are multiple definitions of refinement level or element size for any elements, the latter one will be used.



---

<b>VARIABLE</b>	<b>DESCRIPTION</b>
SSTYP	Slave part type: EQ. 0: Part set ID, EQ. 1: Part ID.
MSTYP	Master part type: EQ. 0: Part set ID, EQ. 1: Part ID.
IBOX1	Box ID for slave parts, See Remark 1.
IBOX2	Box ID for master parts, See Remark 1.
PFACT	Penalty scale factor, See Remark 2.
SRAD	Scale factor for nodes to nodes contact criteria, See Remark 3.

**Remarks:**

1. IBOX1 and IBOX2 are used to define the box IDs for the slave parts and the master parts respectively. Only the particles that inside the boxes are defined for the node to node contacts.
2. For High Velocity Impact problems, a smaller value (ranges from 0.01 to 1.0e-4) of PFACT variable is recommended. A number ranges from 0.1 to 1 is recommended for low velocity contact between two SPH parts.
3. Contact between two SPH particles from different parts is detected when the distance of two SPH particles is less than  $SRAD * (\text{sum of smooth lengths from two particles}) / 2.0$ .

# \*DEFINE

## \*DEFINE\_SPOTWELD\_FAILURE\_RESULTANTS

### \*DEFINE\_SPOTWELD\_FAILURE\_RESULTANTS

Purpose: Define failure criteria between part pairs for predicting spot weld failure. This table is implemented for solid element spot welds, which are used with the tied, constraint based, contact option: \*CONTACT\_TIED\_SURFACE\_TO\_SURFACE. Note that other tied contact types cannot be used. The input in this section continues until then next "\*" card is encountered. Default values are used for any part ID pair that is not defined. Only one table can defined. See \*MAT\_SPOTWELD where this option is used whenever OPT=7.

Card 1            1            2            3            4            5            6            7            8

Variable	ID	DSN	DSS	DLCIDSN	DLCIDSS			
Type	I	F	F	I	I			
Default	0	0.0	0.0	0	0			

**Cards 2, 3, ..., The next "\*" card terminates the table definition.**

Card 2...        1            2            3            4            5            6            7            8

Variable	PID_I	PID_J	SNIJ	SSIJ	LCIDSNIJ	LCIDSSIJ		
Type	I	I	F	F	I	I		
Default	none	none	0.0	0.0	0	0		

<u>VARIABLE</u>	<u>DESCRIPTION</u>
ID	Identification number. Only one table is allowed.
DSN	Default value of the normal static stress at failure.
DSS	Default value of the transverse static stress at failure.
DLCIDSN	Load curve ID defining a scale factor for the normal stress as a function of strain rate. This factor multiplies DSN to obtain the failure value at a given strain rate.
DLCIDSS	Load curve ID defining a scale factor for static shear stress as a function of strain rate. This factor multiplies DSN to obtain the failure value at a given strain rate.

<u>VARIABLE</u>	<u>DESCRIPTION</u>
PID_I	Part ID I.
PID_J	Part ID J.
SNIJ	The maximum axial stress at failure between parts I and J. The axial stress is computed from the solid element stress resultants, which are based on the nodal point forces of the solid element.
DSSIJ	The maximum shear stress at failure between parts I and J. The shear stress is computed from the solid element stress resultants, which are based on the nodal point forces of the solid element.
LCIDSNIJ	Load curve ID defining a scale factor for the normal stress as a function of strain rate. This factor multiplies SNIJ to obtain the failure value at a given strain rate.
LCIDSSIJ	Load curve ID defining a scale factor for static shear stress as a function of strain rate. This factor multiplies SSIJ to obtain the failure value at a given strain rate.

**Remarks:**

The stress based failure model, which was developed by Toyota Motor Corporation, is a function of the peak axial and transverse shear stresses. The entire weld fails if the stresses are outside of the failure surface defined by:

$$\left( \frac{\sigma_{rr}}{\sigma_{rr}^F} \right)^2 + \left( \frac{\tau}{\tau^F} \right)^2 - 1 = 0$$

where  $\sigma_{rr}^F$  and  $\tau^F$  are specified in the above table by part ID pairs. LS-DYNA automatically identifies the part ID of the attached shell element for each node of the spot weld solid and checks for failure. If failure is detected the solid element is deleted from the calculation.

If the effects of strain rate are considered, then the failure criteria becomes:

$$\left( \frac{\sigma_{rr}}{f_{dsn}(\dot{\epsilon}^p) \sigma_{rr}^F} \right)^2 + \left( \frac{\tau}{f_{dss}(\dot{\epsilon}^p) \tau^F} \right)^2 - 1 = 0$$

# \*DEFINE

## \*DEFINE\_SPOTWELD\_MULTISCALE

### \*DEFINE\_SPOTWELD\_MULTISCALE

Purpose: Define beamset->multiscale spotweld type mappings for modeling spotweld failure via the multiscale spotweld method. Any number of cards can be defined.

Card 1            1            2            3            4            5            6            7            8

Variable	TYPE	BSET	TYPE	BSET	TYPE	BSET	TYPE	BSET
Type	I	I	I	I	I	I	I	I
Default	None	None	None	None	None	None	None	none

#### VARIABLE

#### DESCRIPTION

TYPE	MULTISCALE spotweld type to use. See *INCLUDE_SPOTWELD_MULTISCALE
BSET	Beam set which uses this multiscale spotweld type for failure modeling.

#### Remarks:

See \*INCLUDE\_MULTISCALE\_SPOTWELD for a detailed explanation of this capability.

**\*DEFINE\_SPOTWELD RUPTURE\_PARAMETER**

Purpose: Define a parameter by part ID for shell elements attached to spot weld beam elements using the constrained contact option: \*CONTACT\_SPOTWELD. This table will not work with other contact types. Only one table is permitted in the problem definition. Data, which is defined in this table, is used by the stress based spot weld failure model developed by Toyota Motor Corporation. See \*MAT\_SPOTWELD where this option is activated by setting the parameter OPT to a value of 9. This spot weld failure model is a development of Toyota Motor Corporation.

Card 1            1            2            3            4            5            6            7            8

Variable	PID							
Type	I							
Default								

Card 2            1            2            3            4            5            6            7            8

Variable	C11	C12	C13	N11	N12	N13		SIG_PF
Type	F	F	F	F	F	F		F
Default								

Card 3            1            2            3            4            5            6            7            8

Variable	C21	C22	C23	N2				SIG_NF
Type	F	F	F	F				
Default								

# \*DEFINE

## \*DEFINE\_SPOTWELD RUPTURE\_PARAMETER

Card 4            1            2            3            4            5            6            7            8

Variable	LCDPA	LCDPM	LCDPS	LCDNA	LCDNM	LCDNS		NSMT
Type	I	I	I	I	I	I		I
Default	0	0	0	0	0	0		0

### VARIABLE

### DESCRIPTION

PID	Part ID for the attached shell.
C11-N2	Parameters for model, see Remarks below.
SIG_PF	Nugget pull-out stress, $\sigma_P$ .
SIG_NF	Nugget fracture stress, $\sigma_F$ .
LCDPA	Curve ID defining dynamic scale factor of spot weld axial load rate for nugget pull-out mode.
LCDPM	Curve ID defining dynamic scale factor of spot weld moment load rate for nugget pull-out mode.
LCDPS	Curve ID defining dynamic scale factor of spot weld shear load rate for nugget pull-out mode.
LCDNA	Curve ID defining dynamic scale factor of spot weld axial load rate for nugget fracture mode.
LCDNM	Curve ID defining dynamic scale factor of spot weld moment load rate for nugget fracture mode.
LCDNS	Curve ID defining dynamic scale factor of spot weld shear load rate for nugget fracture mode.
NSMT	The number of time steps used for averaging the resultant rates for the dynamic scale factors.

### Remarks:

This failure model incorporates two failure functions, one for nugget pull-out and the other for nugget fracture. The nugget pull-out failure function is



$$F_p = \frac{C11 \cdot A / D^{N11} + C12 \cdot M / D^{N12} + C13 \cdot S / D^{N13}}{\sigma_p \left[ 1 + \left( \frac{\dot{\epsilon}^p}{C} \right)^{1/p} \right]}$$

where A, M, and S are the axial force, moment, and shear resultants respectively, D is the spot weld diameter, and the Cowper-Symonds coefficients are from the attached shell material model. If the Cowper-Symonds coefficients aren't specified, the term within the square brackets, [ ], is 1.0. The fracture failure function is

$$F_n = \frac{\sqrt{(C21 \cdot A + C22 \cdot M)^2 + 3(C23 \cdot S)^2}}{D^{N2} \cdot \sigma_F \left[ 1 + \left( \frac{\dot{\epsilon}^p}{C} \right)^{1/p} \right]}$$

When the load curves for the rate effects are specified, the failure criteria are

$$F_p = \frac{C11 \cdot f_{dpa}(\dot{A}) \cdot A / D^{N11} + C12 \cdot f_{dpa}(\dot{M}) \cdot M / D^{N12} + C13 \cdot f_{dpa}(\dot{S}) \cdot S / D^{N13}}{\sigma_p}$$

$$F_n = \frac{\sqrt{(C21 \cdot f_{dna}(\dot{A}) \cdot A + C22 \cdot f_{dnm}(\dot{M}) \cdot M)^2 + 3(C23 \cdot f_{dns}(\dot{S}) \cdot S)^2}}{D^{N2} \cdot \sigma_F}$$

where f is the appropriate load curve scale factor. The scale factor for each term is set to 1.0 for when no load curve is specified. No extrapolation is performed if the rates fall outside of the range specified in the load curve to avoid negative scale factors. A negative load curve ID designates that the curve abscissa is the  $\log_{10}$  of the resultant rate. This option is recommended when the curve data covers several orders of magnitude in the resultant rate. Note that the load curve dynamic scaling replaces the Cowper-Symonds model for rate effects.

Failure occurs when either of the failure functions is greater than 1.0.

**\*DEFINE\_SPOTWELD RUPTURE\_STRESS**

Purpose: Define a static stress rupture table by part ID for shell elements connected to spot weld beam elements using the constrained contact option: \*CONTACT\_SPOTWELD. This table will not work with other contact types. Only one table is permitted in the problem definition. Data, which is defined in this table, is used by the stress based spot weld failure model developed by Toyota Motor Corporation. See \*MAT\_SPOTWELD where this option is activated by setting the parameter OPT to a value of 6.

**Define rupture stresses part by part. The next “\*” card terminates this input.**

Card	1	2	3	4	5	6	7	8
Variable	PID	SRSIG	SIGTAU	ALPHA				
Type	I	F	F	F				

<u>VARIABLE</u>	<u>DESCRIPTION</u>
PID	Part ID for the attached shell.
SRSIG	Axial (normal) rupture stress, $\sigma_{rr}^F$ .
SRTAU	Transverse (shear) rupture stress, $\tau^F$ .
ALPHA	Scaling factor for the axial stress as defined by Toyota. The default value is 1.0.

**Remarks:**

The stress based failure model, which was developed by Toyota Motor Corporation, is a function of the peak axial and transverse shear stresses. The entire weld fails if the stresses are outside of the failure surface defined by:

$$\left( \frac{\sigma_{rr}}{\sigma_{rr}^F} \right)^2 + \left( \frac{\tau}{\tau^F} \right)^2 - 1 = 0$$

where  $\sigma_{rr}^F$  and  $\tau^F$  are specified in the above table by part ID. LS-DYNA automatically identifies the part ID of the attached shell element for each node of the spot weld beam and independently checks each end for failure. If failure is detected in the end attached to the shell with the greatest plastic strain, the beam element is deleted from the calculation.

If the effects of strain rate are considered, then the failure criteria becomes:

$$\left( \frac{\sigma_{rr}}{\sigma_{rr}^F(\dot{\varepsilon}^p)} \right)^2 + \left( \frac{\tau}{\tau^F(\dot{\varepsilon}^p)} \right)^2 - 1 = 0$$

where  $\sigma_{rr}^F(\dot{\varepsilon}^p)$  and  $\tau^F(\dot{\varepsilon}^p)$  are found by using the Cowper and Symonds model which scales the static failure stresses:

$$\sigma_{rr}^F(\dot{\varepsilon}^p) = \sigma_{rr}^F \cdot \left[ 1 + \left( \frac{\dot{\varepsilon}^p}{C} \right)^{1/p} \right]$$

$$\tau^F(\dot{\varepsilon}^p) = \tau^F \cdot \left[ 1 + \left( \frac{\dot{\varepsilon}^p}{C} \right)^{1/p} \right]$$

where  $\dot{\varepsilon}^p$  is the average plastic strain rate which is integrated over the domain of the attached shell element, and the constants p and C are uniquely defined at each end of the beam element by the constitutive data of the attached shell. The constitutive model is described in the material section under keyword: \*MAT\_PIECEWISE\_LINEAR\_PLASTICITY.

The peak stresses are calculated from the resultants using simple beam theory.

$$\sigma_{rr} = \frac{N_{rr}}{A} + \frac{\sqrt{M_{rs}^2 + M_{rt}^2}}{\alpha Z} \quad \tau = \frac{M_{rr}}{2Z} + \frac{\sqrt{N_{rs}^2 + N_{rt}^2}}{A}$$

where the area and section modulus are given by:

$$A = \pi \frac{d^2}{4}$$

$$Z = \pi \frac{d^3}{32}$$

and d is the diameter of the spot weld beam.

# \*DEFINE

# \*DEFINE\_STAGED\_CONSTRUCTION\_PART

## \*DEFINE\_STAGED\_CONSTRUCTION\_PART\_{OPTION}

Available options include:

<BLANK>

SET

Purpose: Staged construction. This keyword offers a simple way to define parts that are removed (e.g., during excavation), added (e.g., new construction) and used temporarily (e.g., props) during the analysis. Available for solid, shell, and beam element parts.

Note: This keyword card will be available starting in release 3 of version 971.

Card            1            2            3            4            5            6            7            8

Variable	PID/PSID	STGA	STGR					
Type	I	I	I					
Default	none	See Remarks	See Remarks					

### VARIABLE

### DESCRIPTION

PID	Part ID (or Part Set ID for the _SET option)
STGA	Construction stage at which part is added
STGR	Construction stage at which part is removed

### Remarks:

Used with \*DEFINE\_CONSTRUCTION\_STAGES (defines the meaning of stages STGA and STGR) and \*CONTROL\_STAGED\_CONSTRUCTION. If STGA=0, the part is present at the start of the analysis. If STGR=0, the part is still present at the end of the analysis. Examples:

1. Soil that is excavated would have STGA=0 but STGR>0
2. New construction would have STGA>0 and STGR=0
3. Temporary works would have STGA>0, STGR>STGA.

This is a convenience feature that reduces the amount of input data needed for many typical construction models. Internally, LS-DYNA checks for \*LOAD\_REMOVE\_PART, \*LOAD\_GRAVITY\_PART and \*LOAD\_STIFFEN\_PART referencing the same PID. Generally, these will not be present and LS-DYNA creates the data using STGA and STGR, and default gravity and pre-construction stiffness factor from \*CONTROL\_STAGED\_CONSTRUCTION. If existing cards are found, STGA and STGR are inserted into the existing data. During the analysis, any load curves entered on those existing cards will override STGA and STGR.

# \*DEFINE

## \*DEFINE\_TABLE

### \*DEFINE\_TABLE

Purpose: Define a table. This input section is somewhat unique in that another keyword, \*DEFINE\_CURVE, is used as part of the input in this section. A table consists of a \*DEFINE\_TABLE card followed by n lines of input. Each of the n additional lines define a numerical value in ascending order corresponding to a \*DEFINE\_CURVE input which follows the \*DEFINE\_TABLE keyword and the related input. For example, to define strain rate dependency where it is desired to provide a stress versus strain curve for each strain rate, n strain rates would be defined following the \*DEFINE\_TABLE keyword. The curves then follow which make up the table. Each curve may have unique spacing and an arbitrary number of points in their definition. (Load curve ID's defined for the table may be referenced elsewhere in the input.) **However, the curves must not cross except at the origin and the curves must share the same origin and end point.** This rather awkward input is done for efficiency reasons related to the desire to avoid indirect addressing in the inner loops used in the constitutive model stress evaluation.

Card 1                    1                    2                    3                    4                    5                    6                    7                    8

Variable	TBID	SFA	OFFA					
Type	I	F	F					
Default	none	1.	0.					

**Card 2, 3, 4, etc. Put one point per card (E20.0). Input is terminated when a “\*DEFINE\_CURVE” card is found.**

Card 2...                    1                    2                    3                    4

Variable	VALUE			
Type	F			
Default	0.0			

Insert one \*DEFINE\_CURVE input section here for each point defined above.

---

<u>VARIABLE</u>	<u>DESCRIPTION</u>
TBID	Table ID. Tables and Load curves may not share common ID's. LS-DYNA allows load curve ID's and table ID's to be used interchangeably.
SFA	Scale factor for VALUE.
OFFA	Offset for VALUE, see explanation below.
VALUE	Load curve will be defined corresponding to this value, e.g., this value could be a strain rate, see purpose above.

**Remarks:**

1. If for example, 10 stress-strain curves for 10 different strain rates are given, 10 cards with the ascending values of strain rate then follow the first card. Afterwards, 10 corresponding \*DEFINE\_CURVE specifications have to follow.
2. VALUE is scaled in the same manner as in \*DEFINE\_CURVE, i.e.,

$$\text{Scaled value} = \text{SFA} \cdot (\text{Defined value} + \text{OFFA}).$$

# \*DEFINE

## \*DEFINE\_TABLE\_2D

### \*DEFINE\_TABLE\_2D

Purpose: Define a table. Unlike the \*DEFINE\_TABLE keyword above, a curve ID is specified for each value defined in the table. This allows the same curve ID to be referenced by multiple tables, and the curves may be defined anywhere in the input file. As in \*DEFINE\_TABLE, each curve may have unique spacing and an arbitrary number of points in their definition. However, the curves must not cross except at the origin and the curves must share the same origin and end point

Card 1            1            2            3            4            5            6            7            8

Variable	TBID	SFA	OFFA					
Type	I	F	F					
Default	none	1.	0.					

**Card 2, 3, 4, etc. Define one point and curve ID per card (E20.0,I20). Input is terminated when a “\*” card is found.**

Card 2...            1            2            3            4

Variable	VALUE	CURVE ID		
Type	F	I		
Default	0.0	none		

#### VARIABLE

#### DESCRIPTION

TBID	Table ID. Tables and Load curves may not share common ID's. LS-DYNA allows load curve ID's and table ID's to be used interchangeably.
SFA	Scale factor for VALUE.
OFFA	Offset for VALUE, see explanation below.
VALUE	Load curve will be defined corresponding to this value, e.g., this value could be a strain rate for example.



---

<u>VARIABLE</u>	<u>DESCRIPTION</u>
CURVEID	Load curve ID.

**Remarks:**

1. VALUE is scaled in the same manner as in \*DEFINE\_CURVE, i.e.,

$$\text{Scaled value} = \text{SFA} \cdot (\text{Defined value} + \text{OFFA}).$$

**\*DEFINE\_TABLE\_3D**

Purpose: Define a three dimensional table. For each value defined below, a table ID is specified. For example, in a thermally dependent material model, the value given below could correspond to temperature for a table ID defining effective stress versus strain curves for a set of strain rate values. Each table ID can be referenced by multiple three dimensional tables, and the tables may be defined anywhere in the input.

Card 1                    1                    2                    3                    4                    5                    6                    7                    8

Variable	TBID	SFA	OFFA						
Type	I	F	F						
Default	none	1.	0.						

**Card 2, 3, 4, etc. Define one point and table ID per card (E20.0,I20). Input is terminated when a “\*” card is found.**

Card 2...                    1                    2                    3                    4

Variable	VALUE	TABLE ID		
Type	F	I		
Default	0.0	none		

**VARIABLE****DESCRIPTION**

TBID	Table ID. Tables and Load curves may not share common ID's. LS-DYNA allows load curve ID's and table ID's to be used interchangeably.
SFA	Scale factor for VALUE.
OFFA	Offset for VALUE, see explanation below.
VALUE	Load curve will be defined corresponding to this value, e.g., this value could be a strain rate for example.

---

<u>VARIABLE</u>	<u>DESCRIPTION</u>
TABLEID	Table ID.

**Remarks:**

1. VALUE is scaled in the same manner as in \*DEFINE\_CURVE, i.e.,

$$\text{Scaled value} = \text{SFA} \cdot (\text{Defined value} + \text{OFFA}).$$

# \*DEFINE

## \*DEFINE\_TRACER\_PARTICLES\_2D

### \*DEFINE\_TRACER\_PARTICLES\_2D

Purpose: Define tracer particles that follow the deformation of a material. This is useful for visualizing the deformation of a part that is being adapted in a metal forming operation. Nodes used as tracer particles should only be used for visualization and not associated with anything in the model that may alter the response of the model, e.g., they should not be used in any elements except those with null materials.

Card 1            1            2            3            4            5            6            7            8

Variable	NSET	PSET						
Type	I	I						
Default	none	0						

#### VARIABLE

#### DESCRIPTION

NSET	The node set ID for the nodes used as tracer particles.
PSET	Optional part set ID. If this part set is specified, only tracer particles in these parts are updated and the others are stationary. If this part set is not specified, all tracer particles are updated.

**\*DEFINE\_TRANSFORMATION**

Purpose: Define a transformation for the INCLUDE\_TRANSFORM keyword option. The \*DEFINE\_TRANSFORMATION command must be defined before the \*INCLUDE\_TRANSFORM command can be used.

**Cards 1, 2, 3, 4, ... (The next “\*” card terminates the input.) This set is a combination of a series of options listed in the table defined below.**

Card 1            1            2            3            4            5            6            7            8

Variable	TRANID								
Type	I								
Default	none								

Card 2            1            2            3            4            5            6            7            8

Variable	OPTION	A1	A2	A3	A4	A5	A6	A7
Type	A	F	F	F	F	F	F	F

<u>VARIABLE</u>	<u>DESCRIPTION</u>
TRANID	Transform ID.
OPTION	For the available options see the table below.
A1-A7	Specified entity. Each card must have an option specified. See Table 13.1 below for the available options.

<b>FORMAT (A10,7F10.0)</b>		
<b>OPTION</b>	<b>ENTITIES + ATTRIBUTES</b>	<b>FUNCTION</b>
SCALE	a1, a2, a3	Scale the global x, y, and z coordinates of a point by a1, a2, and a3, respectively. If zero, a default of unity is set.
ROTATE	a1, a2, a3, a4, a5, a6, a7	Rotate through an angle (deg), a7, about a line with direction cosines a1, a2, and a3 passing through the point with coordinates a4, a5, and a6.  If a4 through a7 are zero, then a1 and a2 are the ID's of two POINTs and a3 defines the rotation angle. The axis of rotation is defined by a vector going from point with ID a1 to point with ID a2.
TRANSL	a1, a2, a3	Translate the x, y, and z coordinates of a point by a1, a2, and a3, respectively.
POINT	a1,a2,a3,a4	Define a point with ID, a1, with the initial coordinates a2, a3, and a4.
POS6P	a1, a2, a3, a4, a5, a6	Positioning by 6 points. Affine transformation (rotation and translation, no scaling) given by three start points a1, a2, and a3 and three target points a4, a5, and a6. The six POINTs must be defined before they are referenced.

**Table 13.1**

The ordering of the SCALE, ROTATE, and TRANSL commands is important. It is generally recommend to first scale, then rotate, and finally translate the model.

The POINT option in ROTATE provides a means of defining rotations about axes defined by the previous transformations. The coordinates of the two POINTs are transformed by all the transformations up to the transformation where they are referenced. The POINTs must be defined before they are referenced, and their identification numbers are local to each \*DEFINE\_TRANSFORMATION. The coordinates of a POINT are transformed using all the transformations before it is referenced, not just the transformations between its definition and its reference. To put it another way, while the ordering of the transformations is important, the ordering between the POINTs and the transformations is not important.

In the following example, the \*DEFINE\_TRANSFORMATION command is used 3 times to input the same dummy model and position it as follows:

1. Transformation id 1000 imports the dummy model (dummy.k) and rotates it 45 degrees about z-axis at the point (0.0,0.0,0.0). Transformation id 1001 performs the same transformation using the POINT option.
2. Transformation id 2000 imports the same dummy model (dummy.k) and translates 1000 units in the x direction.
3. Transformation id 3000 imports the same dummy model (dummy.k) and translates 2000 units in the x direction. For each \*DEFINE\_TRANSFORMATION, the commands TRANSL, SCALE, and ROTATE are available. The transformations are applied in the order in which they are defined in the file, e.g., transformation id 1000 in this example would translate, scale and then rotate the model. \*INCLUDE\_TRANSFORM uses a transformation id defined by a \*DEFINE\_TRANSFORMATION command to import a model and perform the associated transformations. It also allows the user upon importing the model to apply offsets to the various entity ids and perform unit conversion of the imported model.

```

*KEYWORD
*DEFINE_TRANSFORMATION
  1000
$ option &      dx&      dy&      dz&
TRANSL          0000.0    0.0      0.0
$ option &      dx&      dy&      dz&
SCALE           1.00     1.0      1.0
$ option &      dx&      dy&      dz&      px&      py&      pz&
angle&
ROTATE          0.00     0.0      1.0      0.00     0.00     0.0
45.00
*DEFINE_TRANSFORMATION
  1001
POINT           1        0.0      0.0      0.0
POINT           2        0.0      0.0      1.0
ROTATE          1        2        45.0
*DEFINE_TRANSFORMATION
  2000
$ option &      dx&      dy&      dz&
TRANSL          1000.0    0.0      0.0
*DEFINE_TRANSFORMATION
$ tranid &
  3000
$ option &      dx&      dy&      dz&

TRANSL          2000.0    0.0      0.0
*INCLUDE_TRANSFORM
dummy.k
$idofff &    ideofff&    idpofff& idmofff &    idsofff &    iddofff&    iddofff &
  0          0          0          0          0          0          0
$ idrofff&    ilctmf&
  0          0
$ fctmas&    fcttim&    fctlen&    fcttem &    incout&
  1.0000     1.0000     1.00     1.0      1
$ tranid &
  1000

```

# \*DEFINE

# \*DEFINE\_TRANSFORMATION

```
*INCLUDE_TRANSFORM
dummy.k
$idnoff &   ideoff&   idpoff& idmoff &   idsoff &   iddoftf&   iddoftf &
  1000000   1000000   1000000   1000000   1000000   1000000   1000000
$ idroftf&   ilctmf&
  1000000   1000000
$ fctmas&   fcttim&   fctlen&   fcttem &   incout&
  1.0000   1.0000   1.00    1.00    1
$ tranid &
  2000
*INCLUDE_TRANSFORM
dummy.k
$idnoff &   ideoff&   idpoff& idmoff &   idsoff &   iddoftf&   iddoftf &
  2000000   2000000   2000000   2000000   2000000   2000000   2000000
$ idroftf&   ilctmf&
  2000000   2000000
$ fctmas&   fcttim&   fctlen&   fcttem &   incout&
  1.0000   1.0000   1.00    1.00    1
$ tranid &
  3000
*END
```



**\*DEFINE\_TRIM\_SEED\_POINT\_COORDINATES**

Purpose: The keyword is developed to facilitate blank trimming in a stamping line die simulation. This new keyword allows for the trimming process and inputs to be defined independent of the previous process simulation results.

Card 1            1            2            3            4            5            6            7            8

Variable	NSEED	X1	Y1	Z1	X2	Y2	Z2	
Type	I	F	F	F	F	F	F	
Default	None	0	0	0	0	0.0	0.0	

**VARIABLE**

**DESCRIPTION**

NSEED            Number of seed points. Maximum value of two is allowed.

X1, Y1, Z1        Location coordinates of seed point #1.

X2, Y2, Z2        Location coordinates of seed point #2.

**Remarks:**

1. Variable NSEED is set to the number of seed points desired. For example, in a double attached drawn panel trimming, NSEED would equal to 2.
2. This keyword is used in conjunction with keywords \*ELEMENT\_TRIM and \*DEFINE\_CURVE\_TRIM\_NEW, where variable NSEED should be left as blank. A partial keyword inputs for a single drawn panel trimming is listed below.

```

*INCLUDE_TRIM
drawn.dynain
*ELEMENT_TRIM
  1
*DEFINE_CURVE_TRIM_NEW
$#   TCID   TCTYPE   TFLG   TDIR   TCTOL   TOLN   NSEED
    1       2         11     0.250
trimlines.iges
*DEFINE_TRIM_SEED_POINT_COORDINATES
$   NSEED   X1     Y1     Z1     X2     Y2     Z2
    1   -271.4  89.13  1125.679
*DEFINE_VECTOR
11,0.0,0.0,0.0,0.0,0.0,10.0

```

Typically, seed point coordinates can be selected from the stationary post in home position.

3. This feature is available in LS-DYNA R4 Revision 53048 and later releases.

**\*DEFINE\_VECTOR**

Purpose: Define a vector by defining the coordinates of two points.

Card            1            2            3            4            5            6            7            8

Variable	VID	XT	YT	ZT	XH	YH	ZH	CID
Type	I	F	F	F	F	F	F	I
Default	0	0.0	0.0	0.0	0.0	0.0	0.0	0
Remarks								

**VARIABLE****DESCRIPTION**

VID	Vector ID
XT	X-coordinate of tail of vector
YT	Y-coordinate of tail of vector
ZT	Z-coordinate of tail of vector
XH	X-coordinate of head of vector
YH	Y-coordinate of head of vector
ZH	Z-coordinate of head of vector
CID	Coordinate system ID to define vector in local coordinate system. All coordinates, XT, YT, ZT, XH, YH, and ZH are in respect to CID. EQ.0: global (default).

**Remarks:**

1. The coordinates should differ by a certain margin to avoid numerical inaccuracies.





```

$$$$$$$$$$$$$$$$$$$$$$$$$$$$$$$$$$$$$$$$$$$$$$$$$$$$$$$$$$$$$$$$$$$$$$$$$$$$$$$$$$$$
$
$$$ *DEFINE_CURVE
$
$$$$$$$$$$$$$$$$$$$$$$$$$$$$$$$$$$$$$$$$$$$$$$$$$$$$$$$$$$$$$$$$$$$$$$$$$$$$$$$$$$$$
$
$ Define curve number 517. This particular curve is used to define the
$ force-deflection properties of a spring defined by a *MAT_SPRING_INELASTIC
$ keyword. The abscissa value is offset 25.0 as a means of modeling a gap
$ at the front of the spring. This type of spring would be a compression
$ only spring.
$
*DEFINE_CURVE
$
$.>...1.>...2.>...3.>...4.>...5.>...6.>...7.>...8
$      lcid      sidr      scla      sclo      offa      offo
$          517                25.0
$
$          abscissa      ordinate
$              0.0          0.0
$             80.0          58.0
$             95.0          35.0
$            150.0          44.5
$            350.0          45.5
$
$$$$$$$$$$$$$$$$$$$$$$$$$$$$$$$$$$$$$$$$$$$$$$$$$$$$$$$$$$$$$$$$$$$$$$$$$$$$$$$$$$$$

```

```

$$$$$$$$$$$$$$$$$$$$$$$$$$$$$$$$$$$$$$$$$$$$$$$$$$$$$$$$$$$$$$$$$$$$$$$$$$$$$$$$$$$$
$
$$$ *DEFINE_SD_ORIENTATION
$
$$$$$$$$$$$$$$$$$$$$$$$$$$$$$$$$$$$$$$$$$$$$$$$$$$$$$$$$$$$$$$$$$$$$$$$$$$$$$$$$$$$$
$
$ A discrete spring is defined with two nodes in 3-D space. However, it is
$ desired to have the force of that spring to act only in the z-direction.
$ The following definition makes this happen. Additionally, vid = 7
$ must be specified in the *ELEMENT_DISCRETE keyword for this spring.
$
*DEFINE_SD_ORIENTATION
$
$.>...1.>...2.>...3.>...4.>...5.>...6.>...7.>...8
$      vid      iop      xt      yt      zt      nid1      nid2
$          7          0      0.0      0.0      1.0
$
$$$$$$$$$$$$$$$$$$$$$$$$$$$$$$$$$$$$$$$$$$$$$$$$$$$$$$$$$$$$$$$$$$$$$$$$$$$$$$$$$$$$

```

```

$$$$$$$$$$$$$$$$$$$$$$$$$$$$$$$$$$$$$$$$$$$$$$$$$$$$$$$$$$$$$$$$$$$$$$$$$$$$$$$$
$
$$$$ *DEFINE_VECTOR
$
$$$$$$$$$$$$$$$$$$$$$$$$$$$$$$$$$$$$$$$$$$$$$$$$$$$$$$$$$$$$$$$$$$$$$$$$$$$$$$$$
$
$ Define vector number 5 from (0,0,0) to (0,1,1). As an example, this vector
$ can be used to define the direction of the prescribed velocity of a node
$ using the *BOUNDARY_PRESCRIBED_MOTION_NODE keyword.
$
*DEFINE_VECTOR
$
$.>...1.>...2.>...3.>...4.>...5.>...6.>...7.>...8
$ vid xt yt zt xh yh zh
$ 3 0.0 0.0 0.0 0.0 1.0 1.0
$
$$$$$$$$$$$$$$$$$$$$$$$$$$$$$$$$$$$$$$$$$$$$$$$$$$$$$$$$$$$$$$$$$$$$$$$$$$$$$$$$

```





# **\*DEFORMABLE\_TO\_RIGID**

The cards in this section are defined in alphabetical order and are as follows:

**\*DEFORMABLE\_TO\_RIGID**

**\*DEFORMABLE\_TO\_RIGID\_AUTOMATIC**

**\*DEFORMABLE\_TO\_RIGID\_INERTIA**

If one of these cards is defined, then any deformable part defined in the model may be switched to rigid during the calculation. Parts that are defined as rigid (\*MAT\_RIGID) in the input are permanently rigid and cannot be changed to deformable.

Deformable parts may be switched to rigid at the start of the calculation by specifying them on the \*DEFORMABLE\_TO\_RIGID card.

Part switching may be specified on a restart (see RESTART section of this manual) or it may be performed automatically by use of the \*DEFORMABLE\_TO\_RIGID\_AUTOMATIC cards.

The \*DEFORMABLE\_TO\_RIGID\_INERTIA cards allow inertial properties to be defined for deformable parts that are to be swapped to rigid at a later stage.

It is not possible to perform part material switching on a restart if it was not flagged in the initial analysis. The reason for this is that extra memory needs to be set up internally to allow the switching to take place. If part switching is to take place on a restart, but no parts are to be switched at the start of the calculation, no inertia properties for switching and no automatic switching sets are to be defined, then just define one \*DEFORMABLE\_TO\_RIGID card without further input.

# \*DEFORMABLE\_TO\_RIGID

# \*DEFORMABLE\_TO\_RIGID

## \*DEFORMABLE\_TO\_RIGID

Purpose: Define materials to be switched to rigid at the start of the calculation.

Card            1            2            3            4            5            6            7            8

Variable	PID	MRB	PTYPE					
Type	I	I	A					
Default	none	0						

### VARIABLE

### DESCRIPTION

PID	Part ID of the part which is switched to a rigid material, also see *PART.
MRB	Part ID of the master rigid body to which the part is merged. If zero, the part becomes either an independent or master rigid body.
PTYPE	Type of PID: EQ."PSET": when PID is a part set ID. All parts included in part set PID will be switched to rigid at the start of the calculation.

# **\*DEFORMABLE\_TO\_RIGID\_AUTOMATIC\*DEFORMABLE\_TO\_RIGID**

## **\*DEFORMABLE\_TO\_RIGID\_AUTOMATIC**

Purpose: Define a set of parts to be switched to rigid or to deformable at some stage in the calculation. This command requires (2 + D2R + R2D) cards.

Card 1            1            2            3            4            5            6            7            8

Variable	SWSET	CODE	TIME 1	TIME 2	TIME 3	ENTNO	RELSW	PAIRED
Type	I	I	F	F	F	I	I	I
Default	none	0	0.	1.0E20	0.	0.	0	0
Remark		1				1,2		3

Card 2            1            2            3            4            5            6            7            8

Variable	NRBF	NCSF	RWF	DTMAX	D2R	R2D	OFFSET	
Type	I	I	I	F	I	I	F	
Default	0	0	0	0.	0	0	0	
Remark	4	4	4					

# **\*DEFORMABLE\_TO\_RIGID\*DEFORMABLE\_TO\_RIGID\_AUTOMATIC**

---

<b>VARIABLE</b>	<b>DESCRIPTION</b>
SWSET	Set number for this automatic switch set. Must be unique.
CODE	Activation switch code. Defines the test to activate the automatic material switch of the part: EQ.0: switch takes place at time 1, EQ.1: switch takes place between time 1 and time 2 if rigid wall force (specified below) is zero, EQ.2: switch takes place between time 1 and time 2 if contact surface force (specified below) is zero, EQ.3: switch takes place between time 1 and time 2 if rigid wall force (specified below) is non-zero, EQ.4: switch takes place between time 1 and time 2 if contact surface force (specified below) is non-zero. EQ.5 switch is controlled by *sensor_control with TYPE=DEF2RIG, see *SENSOR_CONTROL. When CODE=5, inputs of column 3 to column 8, TIME1~PAIRED, are ignored.
TIME 1	Switch will not take place before this time.
TIME 2	Switch will not take place after this time: EQ.0 Time 2 set to 1.0e20.
TIME 3	Delay period. After this part switch has taken place, another automatic switch will not take place for the duration of the delay period. If set to zero a part switch may take place immediately after this switch.
ENTNO	Rigid wall/contact surface number for switch codes 1, 2, 3, 4.
RELSW	Related switch set. The related switch set is another automatic switch set that must be activated before this part switch can take place: EQ.0: no related switch set.
PAIRED	Define a pair of related switches. EQ. 0: not paired EQ. 1: paired with switch set RELSW and is the Master switch. EQ.-1: paired with switch set RELSW and is the Slave switch.
NRBF	Flag to delete or activate nodal rigid bodies. If nodal rigid bodies or generalized, weld definitions are active in the deformable bodies that are switched to rigid, then the definitions should be deleted to avoid instabilities: EQ.0: no change, EQ.1: delete, EQ.2: activate.

## **\*DEFORMABLE\_TO\_RIGID\_AUTOMATIC\*DEFORMABLE\_TO\_RIGID**

---

<b>VARIABLE</b>	<b>DESCRIPTION</b>
NCSF	Flag to delete or activate nodal constraint set. If nodal constraint/spot weld definitions are active in the deformable bodies that are switched to rigid, then the definitions should be deleted to avoid instabilities: EQ.0: no change, EQ.1: delete, EQ.2: activate.
RWF	Flag to delete or activate rigid walls: EQ.0: no change, EQ.1: delete, EQ.2: activate.
DTMAX	Maximum permitted time step size after switch.
D2R	Number of deformable parts to be switched to rigid plus number of rigid parts for which new master/slave rigid body combinations will be defined: EQ.0: no parts defined.
R2D	Number of rigid parts to be switched to deformable: EQ.0: no parts defined.
OFFSET	Optional contact thickness for switch to deformable. For contact, its value should be set to a value greater than the contact thickness offsets to ensure the switching occurs prior to impact. This option applies if and only if CODE is set to 3 or 4. For CODE=3 all rigid wall options are implemented. For CODE=4, the implementation works for the contact type CONTACT_AUTOMATIC_ when the options: ONE_WAY_SURFACE_TO_SURFACE, NODES_TO_SURFACE, and SURFACE_TO_SURFACE are invoked.

# **\*DEFORMABLE\_TO\_RIGID\*DEFORMABLE\_TO\_RIGID\_AUTOMATIC**

Define D2R cards below:

Card            1            2            3            4            5            6            7            8

Variable	PID	MRB						
Type	I	I						
Default	none	0						

**VARIABLE**

**DESCRIPTION**

PID                      Part ID of the part which is switched to a rigid material.

MRB                      Part ID of the master rigid body to which the part is merged. If zero, the part becomes either an independent or master rigid body.

Define R2D cards below:

Card            1            2            3            4            5            6            7            8

Variable	PID							
Type	I							
Default	none							

**VARIABLE**

**DESCRIPTION**

PID                      Part ID of the part which is switched to a deformable material.

**Remarks:**

1. Only surface to surface and node to surface contacts can be used to activate an automatic part switch.

## **\*DEFORMABLE\_TO\_RIGID\_AUTOMATIC\*DEFORMABLE\_TO\_RIGID**

2. Rigid wall numbers are the order in which they are defined in the deck. The first rigid wall and the first contact surface encountered in the input deck will have an entity number of 1. The contact surface id is that as defined on the \*CONTACT\_.....\_ID card.
3. Switch sets may be paired together to allow a pair of switches to be activated more than once. Each pair of switches should use consistent values for CODE, i.e. 1&3 or 2&4. Within each pair of switches the related switch, RELSW, should be set to the ID of the other switch in the pair. The Master switch (PAIRED = 1) will be activated before the Slave switch (PAIRED = -1). Pairing allows the multiple switches to take place as for example when contact is made and lost several times during an analysis.
4. If the delete switch is activated, ALL corresponding constraints are deactivated regardless of their relationship to a switched part. By default, constraints which are directly associated with a switched part are deactivated/activated as necessary.

```
$ Define a pair or related switches that will be activated by (no)force on
$ Contact 3. To start with switch set 20 will be activated (PAIRED=1) swapping
$ the PARTS to RIGID. When the contact force is none zero switch set 10 will be
$ activated swapping the PARTS to DEFORMABLE. If the contact force returns to
$ zero switch set 20 will be activated again making the PARTS RIGID.
```

```
$
*DEFORMABLE_TO_RIGID_AUTOMATIC
$.>.....1.>.....2.>.....3.>.....4.>.....5.>.....6.>.....7.>.....8
$ swset code time 1 time 2 time 3 entno relsw paired
 20 2 3 10 1
$ nrbf ncsf rwf dtmax D2R R2D
 1
```

```
*DEFORMABLE_TO_RIGID_AUTOMATIC
$.>.....1.>.....2.>.....3.>.....4.>.....5.>.....6.>.....7.>.....8
$ swset code time 1 time 2 time 3 entno relsw paired
 10 4 3 20 -1
$ nrbf ncsf rwf dtmax D2R R2D
 1
```

# \*DEFORMABLE\_TO\_RIGID \*DEFORMABLE\_TO\_RIGID\_INERTIA

## \*DEFORMABLE\_TO\_RIGID\_INERTIA

Purpose: Inertial properties can be defined for the new rigid bodies that are created when the deformable parts are switched. These can only be defined in the initial input if they are needed in a later restart. Unless these properties are defined, LS-DYNA will recompute the new rigid body properties from the finite element mesh. The latter requires an accurate mesh description. **When rigid bodies are merged to a master rigid body, the inertial properties defined for the master rigid body apply to all members of the merged set.**

Card 1            1            2            3            4            5            6            7            8

Variable	PID							
Type	I							
Default	none							

Card 2            1            2            3            4            5            6            7            8

Variable	XC	YC	ZC	TM				
Type	F	F	F	F				

Card 3            1            2            3            4            5            6            7            8

Variable	IXX	IXY	IXZ	IYY	IYZ	IZZ		
Type	F	F	F	F	F	F		
Default	none	0.0	0.0	none	0.0	none		

### VARIABLE

### DESCRIPTION

PID	Part ID, see *PART.
XC	x-coordinate of center of mass



**\*DEFORMABLE\_TO\_RIGID\_INERTIA    \*DEFORMABLE\_TO\_RIGID**

---

<u>VARIABLE</u>	<u>DESCRIPTION</u>
YC	y-coordinate of center of mass
ZC	z-coordinate of center of mass
TM	Translational mass
IXX	$I_{xx}$ , xx component of inertia tensor
IXY	$I_{xy}$
IXZ	$I_{xz}$
IYY	$I_{yy}$
IYZ	$I_{yz}$
IZZ	$I_{zz}$



# **\*EF**

Exchange factors characterize radiative heat transfer between collections of flat surfaces, the union of which is a closed surface (an enclosure). LS-DYNA can calculate exchange factors and then use them as boundary conditions for thermal runs. The  $(i, j)^{\text{th}}$  element of an exchange factor matrix,  $E_{ij}$ , is the fraction of the Stefan-Boltzman surface energy radiated from surface  $i$  that is absorbed by surface  $j$ . LS-DYNA employs a Monte Carlo algorithm to calculate these exchange factors. For each surface, LS-DYNA simulates photon emission one photon at a time. For each photon, LS-DYNA generates a random initial position on the emitting surfaces as well as a random initial direction that points into the enclosure. LS-DYNA ray traces each photon until it is absorbed. The path of a simulated photon can be complex involving multiple diffuse and specular reflections as well as multiple diffuse and specular transmissions. The results of this Monte Carlo algorithm are used to assemble a matrix that is related to the exchange factor matrix, for which, the  $(i, j)^{\text{th}}$  entry contains the number of photons emitted from surface  $i$  that are absorbed by surface  $j$ . From this matrix LS-DYNA then assembles the exchange factor matrix.

## **Limitations**

The exchange factor algorithm is used to model heat transfer across an enclosure containing a non-participating media. The media within the enclosure is assumed to be transparent to the electromagnetic radiation. For modeling heat transfer across enclosures that are made entirely of diffusively reflecting grey-body surfaces, LS-DYNA features a simpler and faster-running algorithm than the Monte Carlo algorithm, that is, the view factor method (see `*BOUNDARY_RADATION_VF, type=2`). The exchange factor calculation cannot be used concurrently with view factors. A further limitation is that LS-DYNA is capable of including only one exchange factor enclosure per simulation.

## **Output**

The file “exchfl” is a text file containing the exchange factors. This file is written when using the `*BOUNDARY_RADIATION_SET_VF_CALCULATE` keyword and read when using the `*BOUNDARY_RADIATION_SET_VF_READ` keyword.

## **EF Cards**

LS-DYNA requires that the user supply all of the cards listed below unless noted as optional.

- **\*EF\_CONTROL**
- **\*EF\_GRID** (optional)
- **\*EF\_MATERIAL**
- **\*EF\_TOGGLES** (optional)

**\*EF\_CONTROL**

Purpose: This card allows the user to set the parameters for the Monte Carlo algorithm.

This keyword should be used only once.

Card 1            1            2            3            4            5            6            7            8

Variable	NPHTON	NREFS	NWARNS	NLOST	NLOOPS	ERRDEF	INSEED	
Type	I	I	I	I	I	F	I	
Default	None	100	100	100	1	.01	0	

Card 2            1            2            3            4            5            6            7            8

Variable	DELT	SPLTOL	AREATOL	NINCR				
Type	F	F	F	I				
Default	0.01	0.0001	0.0001	0				

**VARIABLE****DESCRIPTION**

NPHTON	The base number of photons emitted per band per surface per convergence loop. Note that NPHT from *BOUNDARY_RADIATION_SET_EF_CALCULATE also effects the number of photons emitted per surface per band per convergence loop.
NREFS	The maximum number of reflections allowed per photon before LS-DYNA issues a warning.
NWARNS	The maximum number of warnings allowed per surface before the run is aborted
NLOST	The maximum number of lost photons allowed per surface. Round off error often causes the loss of photons, so this number ought not to be set too small (usually the default is reasonable).

<b>VARIABLE</b>	<b>DESCRIPTION</b>
NLOOPS	This specifies the maximum number of convergence loops. If the relative error obtained upon the completion of a run is not within the specified tolerances, LS-DYNA will rerun the model combining the results of all previous runs together with the results of the present run to obtain a more accurate result. LS-DYNA will rerun the problem NLOOPS times to achieve error margins within the specified tolerances. If the desired level of convergence is not obtained within NLOOPS iterations LS-DYNA error terminates.
ERRDEF	Specifies that tolerance for convergence of the surface exchange fractions. This may be overridden on a surface by surface basis with the ERRMAX setting. (see *BOUNDARY_RADIATION_SET_EF_CALCULATE)
INSEED	Tells LS-DYNA how to obtain an initial seed for the Monte Carlo random number generator. if(INSEED.eq.0) then [use date and time] if(INSEED.gt.0) then [use INSEED as seed] if(INSEED.lt.0) then [use a default seed]
DELT	The cone angle interval used to numerically integrate material properties.
SPLTOL	To calculate exchange factors, LS-DYNA splits all of the enclosure's quadrilateral surfaces into two triangular surfaces. SPLTOL specifies the amount by which the dot product of the unit normal vectors of the two triangular surfaces can differ from unity.
AREATOL	LS-DYNA splits quadrilateral surfaces in the enclosures along the line connecting the first and third nodes. Quadrilaterals could, just as well, be split along the line connecting the second and fourth nodes. For numerical stability it is important the areas of the triangles created by either splitting be almost identical. AREATOL specifies the largest allowable difference in area.
NINCR	Controls restart-related behavior of LS-DYNA's exchange factor solver. EQ.0 Run normal, no restart files output GT.0 Write restart file after every NINC surfaces

**\*EF\_GRID**

Purpose: This card allows the user to specify grid parameters.

This keyword should appear only once.

Card 1            1            2            3            4            5            6            7            8

Variable	NGX	NGY	NGZ					
Type	I	I	I					
Default	None	None	None					

**VARIABLE****DESCRIPTION**

NGX	The mathematical algorithm underlying the ray tracer, involves gridding the enclosure. NGX specify the number of grid divisions along the x axis. This parameter does not affect LS-DYNA's ability to obtain a solution, but it does effect the amount of CPU time consumed to process each photon. There is no fixed rule for picking NGX, NGY, and NGZ, however for large geometries involving 1,000 to 15,000 surfaces NGX = NGY = NGZ = 25 is often optimal. For smaller geometries smaller values are recommended.
NGY	Specifies the number of grid divisions along the y-axis.
NGZ	Specifies the number of grid divisions along the z-axis.

**\*EF\_MATERIAL**

Purpose: This keyword defines exchange factor material IDs. To define multiple materials use this keyword more than once.

**(Material Specifier)**

Card 1            1            2            3            4            5            6            7            8

Variable	NMAT	NAME						
Type	F	A70						
Default	none	none						

**These next two cards specify the properties of the material.**

Card 2            1            2            3            4            5            6            7            8

Variable	MTYP	EXE	EYE	EZE				
Type	I	F	F	F				
Default	0	0	0	0				

Card 3            1            2            3            4            5            6            7            8

Variable	RHOS	RHOD	TAUS	TAUD	RDIFFR	RDIFFT		
Type	F	F	F	F	F	F		
Default	0	0	0	0	1	1		
Remark	1	1	1	1	2	2		

<b>VARIABLE</b>	<b>DESCRIPTION</b>												
NMAT	Specifies the material ID, of the exchange factor material.												
NAME	Specifies the material's name. This parameter is used only to make the output file easier to read.												
MTYP	Specifies if and how emission occurs: <table border="1" data-bbox="475 527 1408 963"> <thead> <tr> <th>MTYP</th> <th>Material Emission</th> </tr> </thead> <tbody> <tr> <td>-2</td> <td>There is to be no emission and <math>F_{ij} = 1</math> is written to the output file for this surface.</td> </tr> <tr> <td>-1</td> <td>There is to be no emission and <math>F_{ij} = 0</math> is written to the output file for this surface.</td> </tr> <tr> <td>0</td> <td>Emission is to be distributed in <math>\theta</math> according to: <math>\varepsilon(\theta) = \cos^r(\theta)</math></td> </tr> <tr> <td>1</td> <td>Beam emission is to occur in the direction <math>\{E_x, E_y, E_z\}</math></td> </tr> <tr> <td>2</td> <td>This specifies that emission according to user specified function.</td> </tr> </tbody> </table>	MTYP	Material Emission	-2	There is to be no emission and $F_{ij} = 1$ is written to the output file for this surface.	-1	There is to be no emission and $F_{ij} = 0$ is written to the output file for this surface.	0	Emission is to be distributed in $\theta$ according to: $\varepsilon(\theta) = \cos^r(\theta)$	1	Beam emission is to occur in the direction $\{E_x, E_y, E_z\}$	2	This specifies that emission according to user specified function.
MTYP	Material Emission												
-2	There is to be no emission and $F_{ij} = 1$ is written to the output file for this surface.												
-1	There is to be no emission and $F_{ij} = 0$ is written to the output file for this surface.												
0	Emission is to be distributed in $\theta$ according to: $\varepsilon(\theta) = \cos^r(\theta)$												
1	Beam emission is to occur in the direction $\{E_x, E_y, E_z\}$												
2	This specifies that emission according to user specified function.												
EXE	Specifies the x component of emission for a type 1 material.												
EYE	Specifies the y component of emission for a type 1 material.												
EZE	Specifies the z component of emission for a type 1 material.												
RHOS	Specifies the specular reflectance.												
RHOD	Specifies the diffuse reflectance.												
TAUS	Specifies the specular transmittance.												
TAUD	Specifies the diffuse transmittance.												
RDIFFR	LS-DYNA simulates diffuse reflection according to the equation: $\varepsilon(\theta) = \cos^r(\theta)$ . The user specifies the value for r with RDIFFR.												
RDIFFT	LS-DYNA simulates diffuse transmittance according to the equation: $\varepsilon(\theta) = \cos^r(\theta)$ . The user specifies the value for r with RDIFFT.												

**Remarks:**

1. The standard cosine dependent probability function can be replaced with user-defined probability functions. Negative values of this parameter are taken to be material curve



---

Ids that identify such user-defined probability functions. The range of the defined curve is 0 to 90 degrees.

2. Values different from 1 have been observed to result in errors in reciprocity, so the user is strongly encouraged to consider this when selecting values for RDIFFR and RDIFFT different from 1. Lambertian behavior is achieved by using a value of 1. Values greater than 1 result in biasing the distribution toward the normal, whereas values less than one result in biasing the distribution toward the grazing angle.

**\*EF\_TOGGLES**

Purpose: This card allows the user to set output options.

This keyword should be used only once.

Card 1            1            2            3            4            5            6            7            8

Variable	IPRINT1	IPRINT2	IPRINT3	IPRINT4	IDATA	ITRACES	IRSTRT	
Type	I	I	I	I	I	I	I	
Default	0	0	0	0	0	0	0	

**VARIABLE****DESCRIPTION**

IPRINT1	Controls output of exchange fractions to the d3hsp file. In almost all situations this should be set to 0 because the “exchange factors” are written to the file exchfl. EQ.0: do not write exchange fractions EQ.1: write exchange fraction.
IPRINT2	Controls output of a list of lost photons to the d3hsp file. This is useful for debugging. EQ.0: do not write lost photon list EQ.1: write lost photon list
IPRINT3	Controls output about the grid algorithm to the d3hsp file. EQ.0: do not write grid algorithm information EQ.1: write grid algorithm information
IPRINT4	Controls output about material information pertaining to exchange factors to the d3hsp file. EQ.0: do not write material information EQ.1: write material information
IDATA	Controls execution EQ.0: run proceeds EQ.1: terminate after input parameter check
ITRACES	ITRACES Controls output of photon trajectories. EQ.0: do not write trajectory information EQ.1: write trajectory information. This file becomes large quickly

---

<u>VARIABLE</u>	<u>DESCRIPTION</u>
	and is only useful for debugging.
IRESTART	IRESTART should be set either to 1 or 0. If IRESTART is set to 1 then LS-DYNA restarts the exchange factor solver. If IRESTART is set to 1 and a .crh file exists, the Monte Carlo solver will pick up where it left off prior to a crash. If there is a .nij file but no .crh file, then LS-DYNA will recycle the results of the previous exchange factor running emitting more photons to increase accuracy.



# **\*ELEMENT**

The element cards in this section are defined in alphabetical order:

**\*ELEMENT\_BLANKING**  
**\*ELEMENT\_BEAM\_{OPTION}\_{OPTION}**  
**\*ELEMENT\_BEAM\_PULLEY**  
**\*ELEMENT\_DIRECT\_MATRIX\_INPUT**  
**\*ELEMENT\_DISCRETE\_SPHERE**  
**\*ELEMENT\_DISCRETE\_{OPTION}**  
**\*ELEMENT\_GENERALIZED\_SHELL**  
**\*ELEMENT\_GENERALIZED\_SOLID**  
**\*ELEMENT\_INERTIA\_{OPTION}**  
**\*ELEMENT\_INTERPOLATION\_SHELL**  
**\*ELEMENT\_INTERPOLATION\_SOLID**  
**\*ELEMENT\_MASS\_{OPTION}**  
**\*ELEMENT\_MASS\_MATRIX\_{OPTION}**  
**\*ELEMENT\_MASS\_PART\_{OPTION}**  
**\*ELEMENT\_PLOTEL**  
**\*ELEMENT\_SEATBELT**  
**\*ELEMENT\_SEATBELT\_ACCELEROMETER**  
**\*ELEMENT\_SEATBELT\_PRETENSIONER**  
**\*ELEMENT\_SEATBELT\_RETRACTOR**  
**\*ELEMENT\_SEATBELT\_SENSOR**  
**\*ELEMENT\_SEATBELT\_SLIPRING**  
**\*ELEMENT\_SHELL\_{OPTION}**

## **\*ELEMENT**

---

**\*ELEMENT\_SHELL\_NURBS\_PATCH**

**\*ELEMENT\_SHELL\_SOURCE\_SINK**

**\*ELEMENT\_SOLID\_{OPTION}**

**\*ELEMENT\_SPH**

**\*ELEMENT\_TRIM**

**\*ELEMENT\_TSHELL**

The ordering of the element cards in the input file is completely arbitrary. An arbitrary number of element blocks can be defined preceded by a keyword control card.

**\*ELEMENT\_BLANKING**

Purpose: This keyword is used to define a part set to be used in keyword \*DEFINE\_FORMING\_BLANKMESH for a blank mesh generation.

Card 1            1            2            3            4            5            6            7            8

Variable	PSID								
Type	I								
Default	none								

<u><b>VARIABLE</b></u>	<u><b>DESCRIPTION</b></u>
------------------------	---------------------------

PSID	Part set ID, defined by *SET_PART.
------	------------------------------------

**Remarks:**

1. This keyword is used in conjunction with \*DEFINE\_FORMING\_BLANKMESH to generate mesh on a sheet blank for metal forming simulation.
2. This feature is available in LS-DYNA R5 Revision 59165 or later releases.

**\*ELEMENT\_BEAM\_{OPTION}\_{OPTION}**

Available options include:

**<BLANK>**

**THICKNESS, SCALAR, SCALR or SECTION**

**PID**

**OFFSET**

**ORIENTATION**

**WARPAGE**

Purpose: Define two node elements including 3D beams, trusses, 2D axisymmetric shells, and 2D plane strain beam elements. The type of the element and its formulation is specified through the part ID (see \*PART) and the section ID (see \*SECTION\_BEAM).

Two alternative methods are available for defining the cross sectional property data. The THICKNESS and SECTION options are provided for the user to override the \*SECTION\_BEAM data which is taken as the default if the THICKNESS or SECTION option is not used. . The SECTION option applies only to resultant beams (ELFORM.eq.2 on \*SECTION\_BEAM). End release conditions are imposed using constraint equations, and caution must be used with this option as discussed in remark 2 below. The SCALAR/SCALR options applies only to material model type 146, \*MAT\_1DOF\_GENERALIZED\_SPRING.

The PID option is used by the type 9 spot weld element only and is ignored for all other beam types. When the PID option is active an additional card is read that gives two part ID's that are tied by the spot weld element. If the PID option is inactive for the type 9 element the nodal points of the spot weld are located to the two nearest master segments. In either case, \*CONTACT\_SPOTWELD must be defined with the spot weld beam part as slave and the shell parts (including parts PID1 and PID2) as master. The surface of each segment should project to the other and in the most typical case the node defining the weld, assuming only one node is used, should lie in the middle; however, this is not a requirement. Note that with the spot weld elements only one node is needed to define the weld, and two nodes are optional.

The options ORIENTATION and OFFSET are not available for discrete beam elements.



**\*ELEMENT\_BEAM****\*ELEMENT**

Card 1            1            2            3            4            5            6            7            8            9            10

Variable	EID	PID	N1	N2	N3	RT1	RR1	RT2	RR2	LOCAL
Type	I	I	I	I	I	I	I	I	I	I
Default	none	None	none	none	none	0	0	0	0	2
Remarks					1	2,3	2,3	2,3	2,3	2,3

**Optional Card (Required if THICKNESS is specified after the keyword)**

Card            1            2            3            4            5            6            7            8            9            10

Variable	PARAM1	PARAM2	PARAM3	PARAM4	PARAM5
Type	F	F	F	F	F
Remarks	5	5	5	5	5,6

**Optional Card (Required if SECTION is specified after the keyword)**

Card            1            2            3            4            5            6            7            8

Variable	STYPE	D1	D2	D3	D4	D5	D6	
Type	A	F	F	F	F	F	F	
Remarks								

# \*ELEMENT

\*ELEMENT\_BEAM

## Optional Card (Required if SCALAR is specified after the keyword)

Card            1            2            3            4            5            6            7            8            9            10

Variable	VOL	INER	CID	DOFN1	DOFN2
Type	F	F	F	F	F

## Optional Card (Required if SCALR is specified after the keyword)

Card            1            2            3            4            5            6            7            8            9            10

Variable	VOL	INER	CID1	CID2	DOFNS
Type	F	F	F	F	F

## Optional Card (Required if PID is specified after the keyword)

Card            1            2            3            4            5            6            7            8            9            10

Variable	PID1	PID2								
Type	I	I								
Default	none	none								
Remarks										

**Optional Card (Required if OFFSET is specified after the keyword)**

Card            1            2            3            4            5            6            7            8

Variable	WX1	WY1	WZ1	WX2	WY2	WZ2		
Type	F	F	F	F	F	F		
Default	0.0	0.0	0.0	0.0	0.0	0.0		
Remarks	8	8	8	8	8	8		

**Optional Card (Required if ORIENTATION is specified after the keyword)**

Card            1            2            3            4            5            6            7            8

Variable	VX	VY	VZ					
Type	F	F	F					
Default	0.0	0.0	0.0					
Remarks								

**Optional Card (Required if WARPAGE is specified after the keyword)**

Card            1            2            3            4            5            6            7            8

Variable	SN1	SN2						
Type	I	I						
Default	none	none						
Remarks								

<b>VARIABLE</b>	<b>DESCRIPTION</b>
EID	Element ID. A unique ID is generally required, i.e., EID must be different from the element ID's also defined under *ELEMENT_DISCRETE and *ELEMENT_SEATBELT. If the parameter, BEAM, is set to 1 on the keyword input for *DATABASE_BINARY_D3PLOT, the null beams used for visualization are not created for the latter two types, and the ID's used for the discrete elements and the seatbelt elements can be identical to those defined here.
PID	Part ID, see *PART.
N1	Nodal point (end) 1.
N2	Nodal point (end) 2. This node is optional for the spot weld, beam type 9, since if it not defined it will be created automatically and given a non-conflicting nodal point ID. Nodes N1 and N2 are automatically positioned for the spot weld beam element. For the zero length discrete beam elements where one end is attached to ground, set N2=-N1. In this case, a fully constrained nodal point will be created with a unique ID for node N2.
N3	Nodal point 3 for orientation. The third node, N3, is optional for beam types 3, 6, 7, 8, and 9 if the latter, type 9, has a circular cross section. The third node is used for the discrete beam, type 6, if and only if SCOOR is set to 2.0 in the *SECTION_BEAM input, but even in this case it is optional. An orientation vector can be defined directly by using the option, ORIENTATION. In this case N3 can be defined as zero.
RT1, RT2	Release conditions for translations at nodes N1 and N2, respectively: EQ.0: no translational degrees-of-freedom are released EQ.1: x-translational degree-of-freedom EQ.2: y-translational degree-of-freedom EQ.3: z-translational degree-of-freedom EQ.4: x and y-translational degrees-of-freedom EQ.5: y and z-translational degrees-of-freedom EQ.6: z and x-translational degrees-of-freedom EQ.7: x, y, and z-translational degrees-of-freedom (3DOF) This option does not apply to the spot weld, beam type 9.

---

<u>VARIABLE</u>	<u>DESCRIPTION</u>
RR1, RR2	Release conditions for rotations at nodes N1 and N2, respectively: EQ.0: no rotational degrees-of-freedom are released EQ.1: x-rotational degree-of-freedom EQ.2: y-rotational degree-of-freedom EQ.3: z-rotational degree-of-freedom EQ.4: x and y-rotational degrees-of-freedom EQ.5: y and z-rotational degrees-of-freedom EQ.6: z and x-rotational degrees-of-freedom EQ.7: x, y, and z-rotational degrees-of-freedom (3DOF) This option does not apply to the spot weld, beam type 9.
LOCAL	Coordinate system option: EQ.1: global coordinate system EQ.2: local coordinate system (default)
PARM1	Based on beam type: Type.EQ.1: beam thickness, s direction at node 1 Type.EQ.2: area Type.EQ.3: area Type.EQ.4: beam thickness, s direction at node 1 Type.EQ.5: beam thickness, s direction at node 1 Type.EQ.6: volume, see description for VOL below. Type.EQ.7: beam thickness, s direction at node 1 Type.EQ.8: beam thickness, s direction at node 1 Type.EQ.9: beam thickness, s direction at node 1
PARM2	Based on beam type: Type.EQ.1: beam thickness, s direction at node 2 Type.EQ.2: $I_{ss}$ Type.EQ.3: ramp-up time for dynamic relaxation Type.EQ.4: beam thickness, s direction at node 2 Type.EQ.5: beam thickness, s direction at node 2 Type.EQ.6: Inertia, see description for INER below. Type.EQ.7: beam thickness, s direction at node 2 Type.EQ.8: beam thickness, s direction at node 2 Type.EQ.9: beam thickness, s direction at node 2

---

<b>VARIABLE</b>	<b>DESCRIPTION</b>
PARM3	Based on beam type: Type.EQ.1: beam thickness, t direction at node 1 Type.EQ.2: $I_{tt}$ Type.EQ.3: initial stress for dynamic relaxation Type.EQ.4: beam thickness, t direction at node 1 Type.EQ.5: beam thickness, t direction at node 1 Type.EQ.6: local coordinate ID Type.EQ.7: not used. Type.EQ.8: not used. Type.EQ.9: beam thickness, t direction at node 1
PARM4	Based on beam type: Type.EQ.1: beam thickness, t direction at node 2 Type.EQ.2: $I_{rr}$ Type.EQ.3: not used Type.EQ.4: beam thickness, t direction at node 2 Type.EQ.5: beam thickness, t direction at node 2 Type.EQ.6: area Type.EQ.7: not used. Type.EQ.8: not used. Type.EQ.9: beam thickness, t direction at node 2
PARM5	Based on beam type: Type.EQ.1: not used Type.EQ.2: shear area Type.EQ.3: not used Type.EQ.4: not used Type.EQ.5: not used Type.EQ.6: offset Type.EQ.7: not used. Type.EQ.8: not used. Type.EQ.9: print flag to SWFORC file. The default is taken from the SECTION_BEAM input. To override set PARM5 to 1.0 to suppress printing, and to 2.0 to print.

<b>VARIABLE</b>	<b>DESCRIPTION</b>
STYPE	Section type (A format) of resultant beam, see Figure 32.1: EQ.SECTION_01: I-shape      EQ.SECTION_12: Cross EQ.SECTION_02: Channel      EQ.SECTION_13: H-shape EQ.SECTION_03: L-shape      EQ.SECTION_14: T-shape1 EQ.SECTION_04: T-shape      EQ.SECTION_15: I-shape2 EQ.SECTION_05: Tubular box      EQ.SECTION_16: Channel1 EQ.SECTION_06: Z-shape      EQ.SECTION_17: Channel2 EQ.SECTION_07: Trapezoidal      EQ.SECTION_18: T-shape2 EQ.SECTION_08: Circular      EQ.SECTION_19: Box-shape1 EQ.SECTION_09: Tubular      EQ.SECTION_20: Hexagon EQ.SECTION_10: I-shape1      EQ.SECTION_21: Hat-shape EQ.SECTION_11: Solid box      EQ.SECTION_22: Hat-shape1
D1-D6	Input parameters for section option using STYPE above.
PID1	Optional part ID for spot weld element type 9.
PID2	Optional part ID for spot weld element type 9.
VOL	Volume of discrete beam and scalar (mat_146) beam. If the mass density of the material model for the discrete beam is set to unity, the magnitude of the lumped mass can be defined here instead. This lumped mass is partitioned to the two nodes of the beam element. The translational time step size for the type 6 beam is dependent on the volume, mass density, and the translational stiffness values, so it is important to define this parameter. Defining the volume is also essential for mass scaling if the type 6 beam controls the time step size.
INER	Mass moment of inertia for the six degree of freedom discrete beam and scalar (mat_146) beam. This lumped inertia is partitioned to the two nodes of the beam element. The rotational time step size for the type 6 beam is dependent on the lumped inertia and the rotational stiffness values, so it is important to define this parameter if the rotational springs are active. Defining the rotational inertia is also essential for mass scaling if the type 6 beam rotational stiffness controls the time step size.
CID	Coordinate system ID for orientation, material type 146, see *DEFINE_COORDINATE_SYSTEM. If CID=0, a default coordinate system is defined in the global system.
DOFN1	Active degree-of-freedom at node 1, a number between 1 to 6 where 1, 2, and 3 are the x, y, and z-translations and 4, 5, and 6 are the x, y, and z-rotations. This degree-of-freedom acts in the local system given by CID above. This input applies to material model type 146.

<b>VARIABLE</b>	<b>DESCRIPTION</b>
DOFN2	Active degree-of-freedom at node 2, a number between 1 to 6. This degree-of-freedom acts in the local system given by CID above. This input applies to material model type 146.
CID1	Coordinate system ID at node 1 for orientation, material type 146, see *DEFINE_COORDINATE_SYSTEM. If CID1=0, a default coordinate system is defined in the global system.
CID2	Coordinate system ID at node 2 for orientation, material type 146, see *DEFINE_COORDINATE_SYSTEM. If CID2=0, a default coordinate system is defined in the global system.
DOFNS	Active degrees-of-freedom at node 1 and node 2. A two-digit number, the first for node 1 and the second for node 2, between 11 to 66 is expected where 1, 2, and 3 are the x, y, and z-translations and 4, 5, and 6 are the x, y, and z-rotations. These degrees-of-freedom acts in the local system given by CID1 and CID2 above. This input applies to material model type 146. If DOFNS=12 the node one has an x-translation and node 2 has a y translation.
WX1-WZ1	Offset vector at nodal point N1. See Remark 8.
WX2-WZ2	Offset vector at nodal point N2. Set Remark 8.
VX,VY, VZ	Orientation vector at node N1. In this case the orientation nodal point N3, is defined as zero.
SN1	Scalar nodal point (end) 1. This node is required for the WARPAGE option.
SN2	Scalar nodal point (end) 2. This node is required for the WARPAGE option.

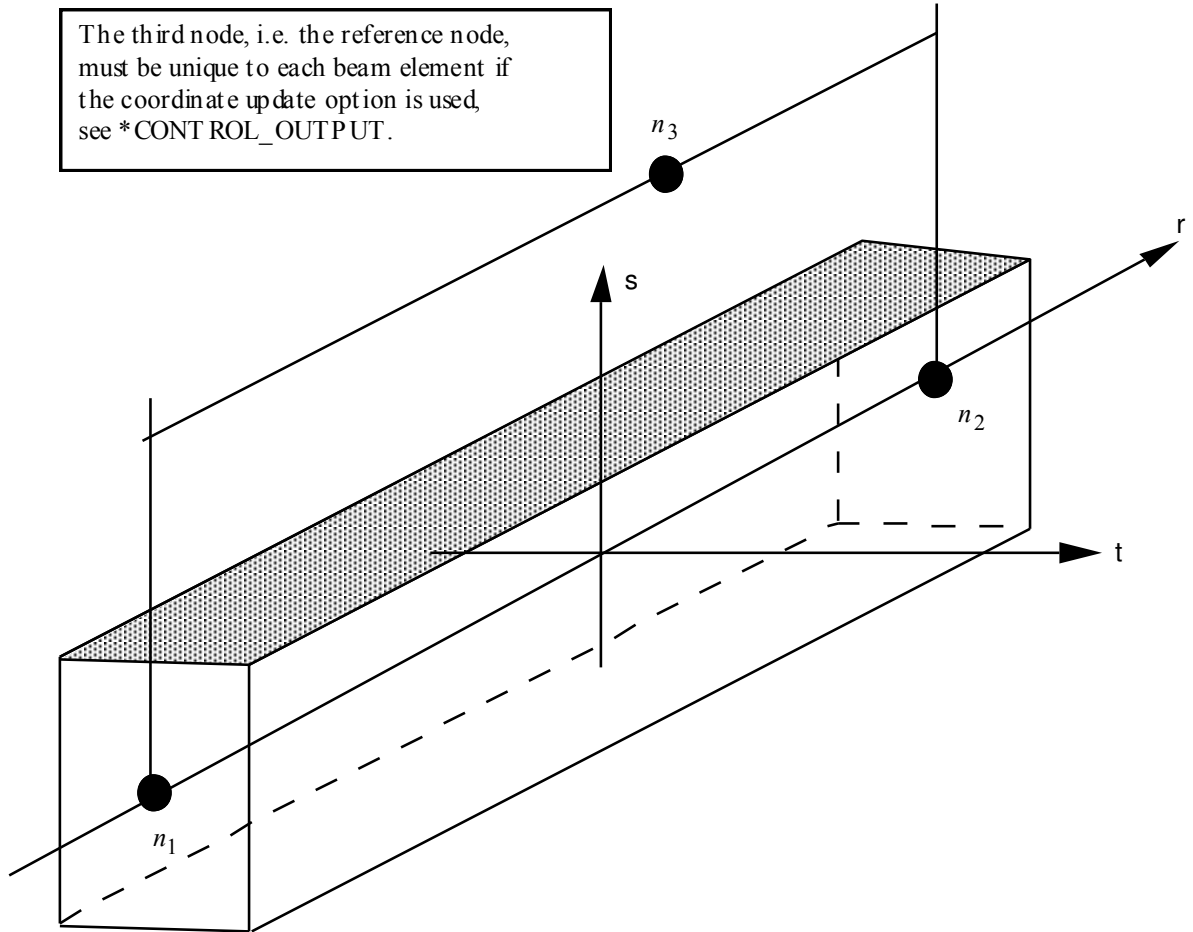
**Remarks:**

1. A plane through  $N_1$ ,  $N_2$ , and  $N_3$  defines the orientation of the principal r-s plane of the beam, see Figure 16.1.
2. This option applies to all three-dimensional beam elements. The released degrees-of-freedom can be either global, or local relative to the local beam coordinate system, see Figure 16.1. A local coordinate system is stored for each node of the beam element and the orientation of the local coordinate systems rotates with the node. To properly track the response, the nodal points with a released resultant are automatically replaced with new nodes to accommodate the added degrees-of-freedom. Then constraint equations are



used to join the nodal points together with the proper release conditions imposed. **Consequently, nodal points which belong to beam elements which have release conditions applied cannot be subjected to other constraints such as applied displacement /velocity/acceleration boundary conditions, nodal rigid bodies, nodal constraint sets, or any of the constraint type contact definitions.** Force type loading conditions and penalty based contact algorithms may be used with this option.

3. Please note that this option may lead to nonphysical constraints if the translational degrees-of-freedom are released, but this should not be a problem if the displacements are infinitesimal.
4. If the THICKNESS option is not used, or if THICKNESS is used but essential PARMx values are not provided, beam properties are taken from \*SECTION\_BEAM.
5. In the case of the THICKNESS option for type 6, i.e., discrete beam elements, PARM1 thru PARM5 replace the first five parameters on card 2 of \*SECTION\_BEAM. Cables are a subset of type 6 beams. PARM1 is for non-cable discrete beams and is optional for cables, PARM2 and PARM3 apply only to non-cable discrete beams, and PARM4 and PARM5 apply only to cables.
6. In the THICKNESS option, PARM5 applies only to beam types 2, 6 (cables only), and 9.
7. The stress resultants are output in local coordinate system for the beam. Stress information is optional and is also output in the local system for the beam.
8. Beam offsets are sometimes necessary for correctly modeling beams that act compositely with other elements such as shells or other beams. When the OFFSET option is specified, global X, Y, and Z components of two offset vectors are given, one vector for each of the two beam nodes. The offset vector extends from the beam node (N1 or N2) to the reference axis of the beam. The beam reference axis lies at the origin of the local s and t axes. For beam formulations 1 and 11, this origin is halfway between the outermost surfaces of the beam cross-section. Note that for cross-sections that are not doubly symmetric, e.g, a T-section, the reference axis does not pass through the centroid of the cross-section. For beam formulation 2, the origin is at the centroid of the cross-section.



**Figure 16.1.** LS-DYNA beam elements. Node  $n_3$  determines the initial orientation of the cross section.

**\*ELEMENT\_BEAM\_PULLEY**

Purpose: Define pulley for beam elements. This feature is only implemented for truss beam elements (\*SECTION\_BEAM, ELFORM=3) and for materials \*MAT\_001 and \*MAT\_156 at the moment.

Card            1            2            3            4            5            6            7            8

Variable	PUID	BID1	BID2	PNID	FD	FS	LMIN	DC
Type	I	I	I	I	F	F	F	F
Default	0	0	0	0	0.0	0.0	0.0	0.0

<u>VARIABLE</u>	<u>DESCRIPTION</u>
PUID	Pulley ID. A unique number has to be used.
BID1	Truss beam element 1 ID.
BID2	Truss beam element 2 ID.
PNID	Pulley node, NID.
FD	Coulomb dynamic friction coefficient.
FS	Optional Coulomb static friction coefficient.
LMIN	Minimum length, see notes below.
DC	Optional decay constant to allow smooth transition between the static and dynamic friction coefficient, i.e., $\mu_c = FD + (FS - FD)e^{-DC \cdot  v_{rel} }$

**Remarks:**

Elements 1 and 2 should share a node which is coincident with the pulley node. The pulley node should not be on any beam elements.

Pulleys allow continuous sliding of a truss beam element through a sharp change of angle. Two elements (1 & 2 in Figure 16.10 of \*ELEMENT\_SEATBELT\_SLIPRING) meet at the pulley. Node B in the beam material remains attached to the pulley node, but beam material (in the form

of unstretched length) is passed from element 1 to element 2 to achieve slip. The amount of slip at each time step is calculated from the ratio of forces in elements 1 and 2. The ratio of forces is determined by the relative angle between elements 1 and 2 and the coefficient of friction, FD. The tension in the beams are taken as  $T_1$  and  $T_2$ , where  $T_2$  is on the high tension side and  $T_1$  is the force on the low tension side. Thus, if  $T_2$  is sufficiently close to  $T_1$ , no slip occurs; otherwise, slip is just sufficient to reduce the ratio  $T_2/T_1$  to  $e^{FC-\theta}$ , where  $\theta$  is the wrap angle, see Figures 16.12 of \*ELEMENT\_SEATBELT\_SLIPRING. The out-of-balance force at node B is reacted on the pulley node; the motion of node B follows that of pulley node.

If, due to slip through the pulley, the unstretched length of an element becomes less than the minimum length LMIN, the beam is remeshed locally: the short element passes through the pulley and reappears on the other side (see Figure 16.10). The new unstretched length of e1 is  $1.1 \times$  minimum length. Force and strain in e2 and e3 are unchanged; force and strain in e1 are now equal to those in e2. Subsequent slip will pass material from e3 to e1. This process can continue with several elements passing in turn through the pulley.

To define a pulley, the user identifies the two beam elements which meet at the pulley, the friction coefficient, and the pulley node. The two elements must have a common node coincident with the pulley node. No attempt should be made to restrain or constrain the common node for its motion will automatically be constrained to follow the pulley node. Typically, the pulley node is part of a structure and, therefore, beam elements should not be connected to this node directly, but any other feature can be attached, including rigid bodies.

**\*ELEMENT\_DIRECT\_MATRIX\_INPUT\_{OPTION}**

Available options include:

**<BLANK>**

**BINARY**

Purpose: Define an element consisting of mass, damping, stiffness, and inertia matrices in a specified file which follows the format used in the direct matrix input, DMIG, of NASTRAN. The supported format is the type 6 symmetric matrix in real double precision. LS-DYNA supports both the standard and the extended precision formats. The binary format from **\*CONTROL\_IMPLICIT\_MODES** or **\*CONTROL\_IMPLICIT\_STATIC\_CONDENSATION** is another input option. The mass and stiffness matrices are required. The inertia matrix is required when using **\*LOAD\_BODY\_OPTION** to correctly compute the action of a prescribed base acceleration on the superelement, otherwise the inertia matrix is unused. The damping matrix is optional. The combination of these matrices is referred to as a superelement. Three input cards are required for each superelement.

The degrees-of-freedom for this superelement may consist of generalized coordinates as well as nodal point quantities. Degrees-of-freedom, defined using **\*NODE** input, are called attachment nodes. Only attachment nodes are included in the output to the ASCII and binary databases.

The matrices for a given superelement can be of different order. However, the explicit integration scheme requires the inversion of the union of the element mass matrix and nodal masses associated with attachment nodes. Any degree of freedom included in the other (stiffness, damping, inertia) matrices but without nonzero columns in the combined mass matrix will be viewed as massless and constrained not to move. After deleting zero rows and columns the combined mass matrix is required to be positive definite.

The inertia matrix is required to have 3 columns which corresponds to the 3 global coordinates. It is used to compute the forces acting on the superelement by multiplying the inertia matrix times the gravitational acceleration specified via **\*LOAD\_BODY\_OPTION**.

There is no assumption made on the order of the matrices nor the sparse matrix structure of the element matrices except that they are symmetric and the combined mass matrix is invertible as described above.

Multiple elements may be input using **\*ELEMENT\_DIRECT\_MATRIX\_INPUT**. They may share attachment nodes with other direct matrix input elements. Only **\*BOUNDARY\_PRESCRIBED\_MOTION** and global constraints imposed via **\*NODE** or **\*BOUNDARY\_SPC** on attachment nodes can be applied in explicit applications. Implicit applications can have additional constraints on attachment nodes.

# \*ELEMENT

# \*ELEMENT\_DIRECT\_MATRIX\_INPUT

Card 1            1            2            3            4            5            6            7            8

Variable	EID	IFRMT						
Type	I	0						

Card 2            1            2            3            4            5            6            7            8

Variable	FILENAME							
Type	C							

Card 3            1            2            3            4            5            6            7            8

Variable	MASS	DAMP	STIF	INERT				
Type	C	C	C	C				

## VARIABLE

## DESCRIPTION

EID	Super element ID.
IFRMT	Format: EQ.0: standard format NE.0: extended precision format
MASS	Name of mass matrix in the file defined by FILENAME. This filename should be no more than eight characters to be compatible with NASTRAN.
DAMP	Name of damping matrix in the file defined by FILENAME. This filename should be no more than eight characters to be compatible with NASTRAN.
STIF	Name of stiffness matrix in the file defined by FILENAME. This filename should be no more than eight characters to be compatible with NASTRAN.

---

<u>VARIABLE</u>	<u>DESCRIPTION</u>
INERT	Name of inertia matrix in the file defined by FILENAME. This filename should be no more than eight characters to be compatible with NASTRAN. This file must be present when *LOAD_BODY is used to put gravitational forces on the model.

**\*ELEMENT\_DISCRETE\_{OPTION}**

Available options include:

&lt;BLANK&gt;

**LCO**

Purpose: Define a discrete (spring or damper) element between two nodes or a node and ground. An option, LCO, is available for using a load curve(s) to initialize the offset to avoid the excitation of numerical noise that can sometimes result with an instantaneous imposition of the offset. This can be done using a single curve at the start of the calculation or two curves where the second is used during dynamic relaxation prior to beginning the transient part. In the latter case, the first curve would simply specify the offset as constant during time. If the LCO option is active, a second card is read. It is recommended that beam type 6, see \*ELEMENT\_BEAM and SECTION\_BEAM, be used whenever possible, especially if orientation is specified. The latter option tends to be more accurate and cost effective. The \*ELEMENT\_DISCRETE option is no longer being developed and extended

Note: The discrete elements enter into the time step calculations. Care must be taken to ensure that the nodal masses connected by the springs and dampers are defined and unrealistically high stiffness and damping values must be avoided. **All rotations are in radians.**

Card            1            2            3            4            5            6            7            8            9            10

Variable	EID	PID	N1	N2	VID	S	PF	OFFSET
Type	I	I	I	I	I	F	I	F
Default	none	none	none	none	0	1.	0	0



Define this card if and only if the option LCO is active

Card 2            1            2            3            4            5            6            7            8

Variable	LCID	LCIDDR						
Type	I	I						
Default	none	none						

**VARIABLE****DESCRIPTION**

EID	Element ID. A unique number is required. Since null beams are created for visualization, this element ID should not be identical to element ID's defined for ELEMENT_BEAM and ELEMENT_SEATBELT.
PID	Part ID, see *PART.
N1	Nodal point 1.
N2	Nodal point 2. If zero, the spring/damper connects node N1 to ground.
VID	Orientation option. The orientation option should be used cautiously since forces, which are generated as the nodal points displace, are not orthogonal to rigid body rotation unless the nodes are coincident.. The type 6, 3D beam element, is recommended when orientation is required with the absolute value of the parameter SCOOR set to 2 or 3, since this option avoids rotational constraints. EQ.0: the spring/damper acts along the axis from node N1 to N2, NE.0: the spring/damper acts along the axis defined by the orientation vector, VID defined in the *DEFINE_SD_ORIENTATION section.
S	Scale factor on forces.
PF	Print flag: EQ.0: forces are printed in DEFORC file, EQ.1: forces are not printed DEFORC file.
OFFSET	Initial offset. The initial offset is a displacement or rotation at time zero. For example, a positive offset on a translational spring will lead to a tensile force being developed at time zero. Ignore this input if LCID is defined below.

<u>VARIABLE</u>	<u>DESCRIPTION</u>
LCID	Load curve ID defining the initial OFFSET as a function of time. Positive offsets correspond to tensile forces, and, likewise negative offset result incompressive forces.
LCIDDR	Load curve ID defining OFFSET as a function of time during the dynamic relaxation phase.

**\*ELEMENT\_DISCRETE\_SPHERE**

Purpose: Define a discrete spherical element for discrete element calculations. Each particle consists of a single node with its mass, mass moment of inertia, and radius defined by the input below. Initial coordinates and velocities are specified via the nodal data. The element ID corresponds to the ID of the node. The discrete spherical elements are visualized in LS-PREPOST using the same options as the SPH elements.

Card 1            1            2            3            4            5            6            7            8

Variable	NID	PID	MASS	INERTIA	RADIUS			
Type	I	I	F	F	F			
Default	none	none	none	none	none			

<u>VARIABLE</u>	<u>DESCRIPTION</u>
NID	Node ID.
PID	Part ID, see *PART.
MASS	Mass
INERTIA	Mass moment of inertia.
RADIUS	Particle radius. The particle radius is used for defining contact between particles.

# \*ELEMENT

# \*ELEMENT\_GENERALIZED\_SHELL

## \*ELEMENT\_GENERALIZED\_SHELL

Purpose: Define a general 3D shell element with an arbitrary number of nodes. The formulation of this element is specified in \*DEFINE\_ELEMENT\_GENERALIZED\_SHELL, which is specified through the part ID (see \*PART) and the section ID (see \*SECTION\_SHELL). For an illustration of this referencing, see Figure 16.2. Using this generalized shell implementation allows a rapid prototyping of new shell element formulations without further coding.

The element formulation used in \*SECTION\_SHELL needs to be greater or equal than 1000.

### Card Format (8I10)

Card 1            1            2            3            4            5            6            7            8

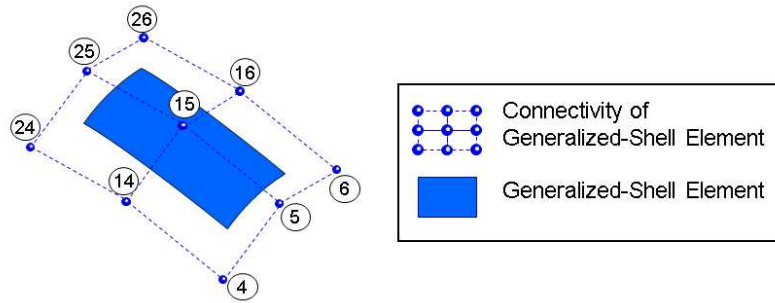
Variable	EID	PID	NMNP					
Type	I	I	I					
Default	none	none	none					

**Define the connectivity of the element by specifying NMNP-nodes (up to eight nodes per card). Define as many cards as needed**

Card 2            1            2            3            4            5            6            7            8

Variable	N1	N2	N3	N4	N5	N6	N7	N8
Type	I	I	I	I	I	I	I	I
Default	none	none	none	none	none	none	none	none





```

*ELEMENT_GENERALIZED_SHELL
$---+---EID---+---PID---+---NMNP---+---4---+---5---+---6---+---7---+---8
      1          11          9
$---+---N1---+---N2---+---N3---+---N4---+---N5---+---N6---+---N7---+---N8
      26        25        24        16        15        14        6        5
$---+---N9---+---Etc---+---Etc---+---Etc---+---Etc---+---Etc---+---Etc---+---Etc
      4
*PART
Part for generalized shell
$---+---PID---+---SECID---+---MID---+---4---+---5---+---6---+---7---+---8
      11        15          3
*SECTION_SHELL
$---+---SECID---+---ELFORM---+---SHRF---+---NIP---+---5---+---6---+---7---+---8
      15        1001          2
$---+---T1---+---T2---+---T3---+---T4---+---5---+---6---+---7---+---8
      1.0
*DEFINE_ELEMENT_GENERALIZED_SHELL
$---+---ELFORM---+---NGP---+---NMNP---+---IMASS---+---FORM---+---6---+---7---+---8
      1001        4          9          0          1
...
    
```

**Figure 16.2.** Example of the connection between \*ELEMENT\_GENERALIZED\_SHELL and \*DEFINE\_ELEMENT\_GENERALIZED\_SHELL

**\*ELEMENT\_GENERALIZED\_SOLID**

Purpose: Define a general 3D solid element with an arbitrary number of nodes. The formulation of this element is specified in \*DEFINE\_ELEMENT\_GENERALIZED\_SOLID, which is referenced through the part ID (see \*PART) and the section ID (see \*SECTION\_SOLID). For an illustration of this referencing, see Figure 16.3. Using this generalized solid implementation allows a rapid prototyping of new solid element formulations without further coding.

The element formulation used in \*SECTION\_SOLID needs to be greater or equal than 1000.

**Card Format (8I10)**

Card 1            1            2            3            4            5            6            7            8

Variable	EID	PID	NMNP					
Type	I	I	I					
Default	none	none	none					

**Define the connectivity of the element by specifying NMNP-nodes (up to eight nodes per card). Define as many cards as needed**

Card 2            1            2            3            4            5            6            7            8

Variable	N1	N2	N3	N4	N5	N6	N7	N8
Type	I	I	I	I	I	I	I	I
Default	none	none	none	none	none	none	none	none

Cards            1            2            3            4            5            6            7            8

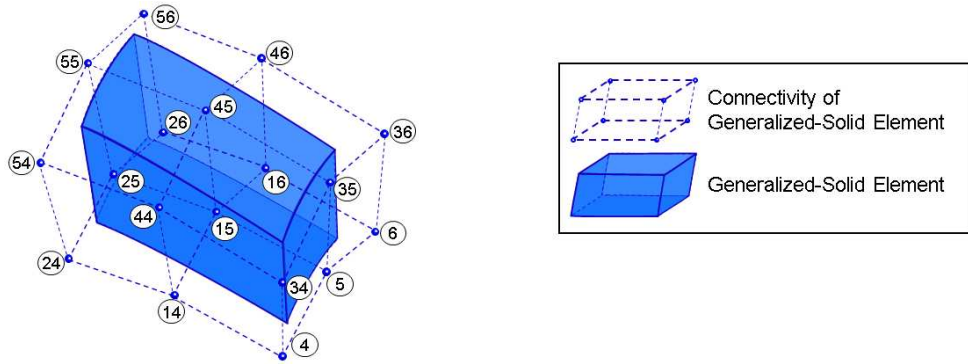
Variable	N9	N10	Etc.	Etc.	Etc.	Etc.	Etc.	Etc.
Type	I	I	I	I	I	I	I	I
Default	none	none	none	none	none	none	none	none

<u>VARIABLE</u>	<u>DESCRIPTION</u>
EID	Element ID. Chose a unique number with respect to other elements.
PID	Part ID, see *PART.
NMNP	Number of nodes to define this element.
$N_i$	Nodal point i (defined via *NODE) to define connectivity of this element.

**Remarks:**

9. For post-processing the use of interpolation solid elements (see \*ELEMENT\_INTERPOLATION\_SOLID and \*CONSTRAINED\_NODE\_INTERPOLATION) is necessary.
10. The definition of the connectivity of the element is basically arbitrary but it has to be in correlation with the definition of the element formulation in \*DEFINE\_ELEMENT\_GENERALIZED\_SOLID.





```
*ELEMENT_GENERALIZED_SOLID
$-----EID-----+---PID-----+---NMNP-----+---4-----+---5-----+---6-----+---7-----+---8
1          11          18
$-----N1-----+---N2-----+---N3-----+---N4-----+---N5-----+---N6-----+---N7-----+---N8
56         55         54         46         45         44         36         35
$-----N9-----+---N10-----+---N11-----+---N12-----+---N13-----+---N14-----+---N15-----+---N16
34         26         25         24         16         15         14         6
$-----N17-----+---N18-----+---Etc-----+---Etc-----+---Etc-----+---Etc-----+---Etc-----+---Etc
5          4

*PART
Part for generalized solid
$-----PID-----+---SECID-----+---MID-----+---4-----+---5-----+---6-----+---7-----+---8
11         15         3
*SECTION_SOLID
$-----SECID-----+---ELFORM-----+---AET-----+---4-----+---5-----+---6-----+---7-----+---8
15         1001      2
*DEFINE_ELEMENT_GENERALIZED_SOLID
$-----ELFORM-----+---NGP-----+---NMNP-----+---IMASS-----+---5-----+---6-----+---7-----+---8
1001      8         18         0
```

Figure 16.3. Example of the connection between \*ELEMENT\_GENERALIZED\_SOLID and \*DEFINE\_ELEMENT\_GENERALIZED\_SOLID

# \*ELEMENT

# \*ELEMENT\_INERTIA

## \*ELEMENT\_INERTIA\_{OPTION}

Available options include:

<BLANK>

**OFFSET**

to allow the lumped mass and inertia tensor to be offset from the nodal point. The nodal point can belong to either a deformable or rigid node.

Purpose: Define a lumped inertia element assigned to a nodal point.

Card 1            1            2            3            4            5            6            7            8            9            10

Variable	EID	NID	CSID							
Type	I	I	I							
Default	none	none	none							
Remarks			1							

Card 2            1            2            3            4            5            6            7            8

Variable	IXX	IXY	IXZ	IYY	IYZ	IZZ	MASS	
Type	F	F	F	F	F	F	F	
Default	0.0	0.0	0.0	0.0	0.0	0.0	0.0	
Remarks		2	2		2			

**Define if and only if the OFFSET option is active. Card Format (3E10.0)**

Card            1            2            3            4            5            6            7            8

Variable	X-OFF	Y-OFF	Z-OFF					
Type	F	F	F					
Default	0.	0.	0.					
Remarks		2	2					

<u>VARIABLE</u>	<u>DESCRIPTION</u>
EID	Element ID. A unique number must be used.
NID	Node ID. Node to which the mass is assigned.
CSID	Coordinate set ID EQ.0: global inertia tensor GE.1: principal moments of inertias with orientation vectors defined by Coordinate set CSID. See *DEFINE_COORDINATE_SYSTEM and *DEFINE_COORDINATE_VECTOR.
IXX	XX component of inertia tensor.
IXY	XY component of inertia tensor.
IXZ	XZ component of inertia tensor.
IYY	YY component of inertia tensor.
IYZ	YZ component of inertia tensor.
IZZ	ZZ component of inertia tensor.
MASS	Lumped mass
X-OFF	x-offset from nodal point.
Y-OFF	y-offset from nodal point.
Z-OFF	z-offset from nodal point.

**Remarks:**

1. The coordinate system cannot be defined for this element using the option \*DEFINE\_COORDINATE\_NODE.
2. If CSID is defined then IXY, IXZ and IYZ are set to zero. The nodal inertia tensor must be positive definite, i.e., its determinant must be greater than zero, since its inverse is required. This check is done after the nodal inertia is added to the defined inertia tensor.

**\*ELEMENT\_INTERPOLATION\_SHELL**

Purpose: With the definition of interpolation shells, the stresses and other solution variables can be interpolated from the generalized shell elements (see \*ELEMENT\_GENERALIZED\_SHELL and \*DEFINE\_ELEMENT\_GENERALIZED\_SHELL) permitting the solution to be visualized using standard 4-noded shell elements with one integration point (one value of each solution variable per interpolation shell). The definition of the interpolation shells is based on interpolation nodes (see \*CONSTRAINED\_NODE\_INTERPOLATION). The connection between these various keywords are illustrated in Figure 16.4.

**Card Format (8I10)**

Card 1            1            2            3            4            5            6            7            8

Variable	EIDS	EIDGS	NGP						
Type	I	I	I						
Default	none	none	none						

**Define for every in-plane integration point (NGP) of the master element (\*ELEMENT\_GENERALIZED\_SHELL) the appropriate weighting factor for the interpolation of the solution to the center of this interpolation shell (up to four weights per card). Define as many cards as needed**

Cards            1            2            3            4            5            6            7            8

Variable	IP1	W1	IP2	W2	IP3	W3	IP4	W4
Type	I	F	I	F	I	F	I	F
Default	none	none	none	none	none	none	none	none

# \*ELEMENT

# \*ELEMENT\_INTERPOLATION\_SHELL

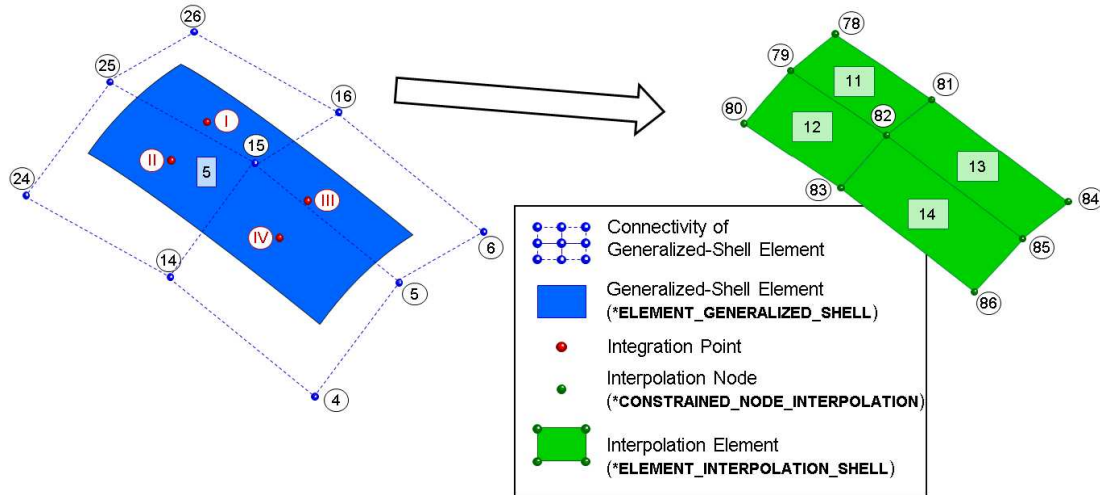
Cards	1	2	3	4	5	6	7	8
Variable	IP5	W5	Etc.	Etc.	Etc.	Etc.	Etc.	Etc.
Type	I	F	I	F	I	F	I	F
Default	none	none	none	none	none	none	none	none

<u>VARIABLE</u>	<u>DESCRIPTION</u>
-----------------	--------------------

EIDS	Element ID of the interpolation shell. This needs to coincide with a proper definition of a 4-noded shell element (*ELEMENT_SHELL) using interpolation nodes (*CONSTRAINED_NODE_INTERPOLATION).
EIDGS	Element ID of the master element defined in *ELEMENT_GENERALIZED_SHELL.
NGP	Number of in-plane integration points of the master element.
IP <sub>i</sub>	Integration point number (1 to NGP) in the order how they were defined in *DEFINE_ELEMENT_GENERALIZED_SHELL.
W <sub>i</sub>	Interpolation weight of integration point i.

### Remarks:

11. For each interpolation shell element, one single value ( $v_{IS}$ ) of a solution variable is interpolated based on values at the integration points ( $v_i$ ) of the master element (\*ELEMENT\_GENERALIZED\_SHELL) and the appropriate weighting factors ( $w_i$ ). The interpolation is computed as follows:  $v_{IS} = \sum_{i=1}^{NGP} w_i v_i$
12. To use \*ELEMENT\_INTERPOLATION\_SHELL, ELFORM=98 has to be used in \*SECTION\_SHELL



```

*CONSTRAINED_NODE_INTERPOLATION
$---+---NID---+NUMMN---+---3---+---4---+---5---+---6---+---7---+---8
      78      4
$---+---MN1---+---W1---+---MN2---+---W2---+---MN3---+---W3---+---MN4---+---W4
      26      0.35      25      0.32      15      0.18      16      0.15

*ELEMENT_SHELL
$---+---EID---+---PID---+---N1---+---N2---+---N3---+---N4---+---N5---+---N6---+---N7---+---N8
      11      33      78      79      82      81

*PART
Part for interpolation shell
$---+---PID---+---SECID---+---MID---+---4---+---5---+---6---+---7---+---8
      33      45      3

*SECTION_SHELL
$---+---SECID---+---ELFORM---+---SHRF---+---NIP---+---5---+---6---+---7---+---8
      45      98      2
$---+---T1---+---T2---+---T3---+---T4---+---5---+---6---+---7---+---8
      1.0

*ELEMENT_INTERPOLATION_SHELL
$---+---EIDS---+---EIDGS---+---NGP---+---4---+---5---+---6---+---7---+---8
      11      5      4
$---+---IP1---+---W1---+---IP2---+---W2---+---IP3---+---W3---+---IP4---+---W4
      1      0.5      2      0.2      3      0.2      4      0.1
  
```

Figure 16.4. Example for \*ELEMENT\_INTERPOLATION\_SHELL

**\*ELEMENT\_INTERPOLATION\_SOLID**

Purpose: With the definition of interpolation solids, the stresses and other solution variables can be interpolated from the generalized solid elements (see \*ELEMENT\_GENERALIZED\_SOLID and \*DEFINE\_ELEMENT\_GENERALIZED\_SOLID) permitting the solution to be visualized using standard 8-noded solid elements with one integration point (one value of each solution variable per interpolation solid). The definition of the interpolation solids is based on interpolation nodes (see \*CONSTRAINED\_NODE\_INTERPOLATION). The connection between these various keywords are illustrated in Figure 16.5.

**Card Format (8I10)**

Card 1            1            2            3            4            5            6            7            8

Variable	EIDS	EIDGS	NGP						
Type	I	I	I						
Default	none	none	none						

**Define for every in-plane integration point (NGP) of the master element (\*ELEMENT\_GENERALIZED\_SOLID) the appropriate weighting factor for the interpolation of the solution to the center of this interpolation solid (up to four weights per card). Define as many cards as needed**

Cards            1            2            3            4            5            6            7            8

Variable	IP1	W1	IP2	W2	IP3	W3	IP4	W4
Type	I	F	I	F	I	F	I	F
Default	none	none	none	none	none	none	none	none



Cards            1            2            3            4            5            6            7            8

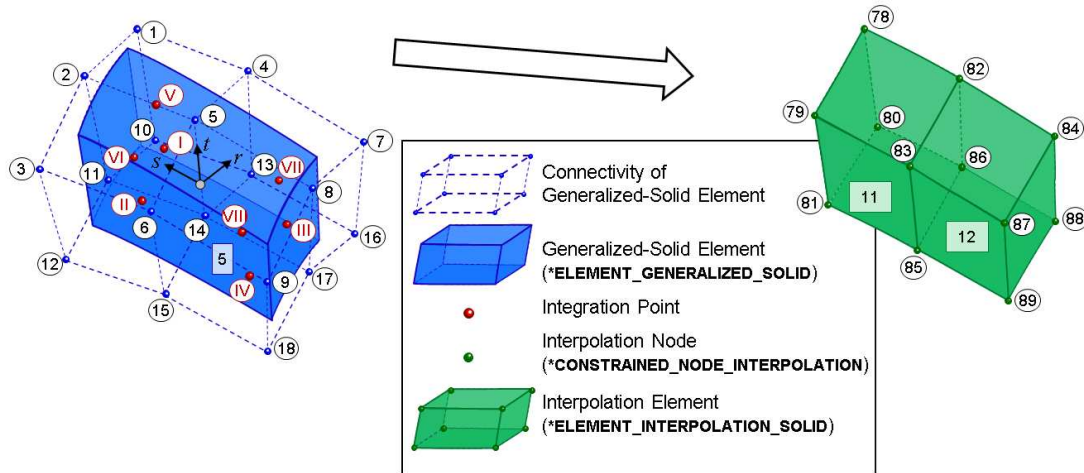
Variable	IP5	W5	Etc.	Etc.	Etc.	Etc.	Etc.	Etc.
Type	I	F	I	F	I	F	I	F
Default	none	none	none	none	none	none	none	none

<u>VARIABLE</u>	<u>DESCRIPTION</u>
-----------------	--------------------

EIDS	Element ID of the interpolation solid. This needs to coincide with a proper definition of a 8-noded solid element (*ELEMENT_SOLID) using interpolation nodes (*CONSTRAINED_NODE_INTERPOLATION).
EIDGS	Element ID of the master element defined in *ELEMENT_GENERALIZED_SOLID.
NGP	Number of integration points of the master element.
IP <sub>i</sub>	Integration point number (1 to NGP) in the order how they were defined in *DEFINE_ELEMENT_GENERALIZED_SOLID.
W <sub>i</sub>	Interpolation weight of integration point i.

**Remarks:**

- For each interpolation solid element, one single value ( $v_{IS}$ ) of a solution variable is interpolated based on values at the integration points ( $v_i$ ) of the master element (\*ELEMENT\_GENERALIZED\_SOLID) and the appropriate weighting factors ( $w_i$ ). The interpolation is computed as follows:  $v_{IS} = \sum_{i=1}^{NGP} w_i v_i$
- To use \*ELEMENT\_INTERPOLATION\_SOLID, ELFORM=98 has to be used in \*SECTION\_SOLID



```

*ELEMENT_SOLID
$--+EID--+ PID----- N1-----N2-----N3-----N4-----N5-----N6-----N7-----N8
    11      33
$--+N1-----N2-----N3-----N4-----N5-----N6-----N7-----N8-----N9-----N10
    80      81      85      86      78      79      83      82

*PART
Part for interpolation solid
$--+PID-----SECID-----MID-----4-----5-----6-----7-----8
    33      45      3

*SECTION_SOLID
$--+SECID-----ELFORM-----AET-----4-----5-----6-----7-----8
    45      98

*ELEMENT_INTERPOLATION_SOLID
$--+EIDS--+ EIDGS--+ NGP--+ 4--+ 5--+ 6--+ 7--+ 8
    11      5      8
$--+IP1--+ W1--+ IP2--+ W2--+ IP3--+ W3--+ IP4--+ W4
    1      0.30  2      0.12  3      0.13  4      0.07
$--+IP5--+ W5--+ IP6--+ W6--+ IP7--+ W7--+ IP8--+ W8
    5      0.20  6      0.08  7      0.07  8      0.03
    
```

**Figure 16.5.** Example for \*ELEMENT\_INTERPOLATION\_SOLID

**\*ELEMENT\_MASS\_{OPTION}**

Available options include:

**<BLANK>**

**NODE\_SET**

Purpose: Define a lumped mass element assigned to a nodal point or equally distributed to the nodes of a node set.

(Note: NODE\_SET option is available starting with the R3 release of Version 971.)

Card            1            2            3            4            5            6            7            8            9            10

Variable	EID	ID	MASS	PID						
Type	I	I	F	I						
Default	none	None	0.	none						

<u>VARIABLE</u>	<u>DESCRIPTION</u>
EID	Element ID. A unique number is recommended. The nodes in a node set share the same element ID.
ID	Node ID or node set ID if the NODE_SET option is active. This is the node or node set to which the mass is assigned.
MASS	Mass value. When the NODE_SET option is active, the mass is equally distributed to all nodes in a node set.
PID	Part ID. This input is optional.

# \*ELEMENT

# \*ELEMENT\_MASS\_MATRIX

## \*ELEMENT\_MASS\_MATRIX\_{OPTION}

Available options include:

<BLANK>

NODE\_SET

Purpose: Define a 6x6 symmetric nodal mass matrix assigned to a nodal point or each node within a node set

Card 1            1            2            3            4            5            6            7            8

Variable	EID	ID	CID					
Type	I	I	I					
Default	none	none	0					

Card 2            1            2            3            4            5            6            7            8

Variable	M11	M21	M22	M31	M32	M33	M41	
Type	F	F	F	F	F	F	F	
Default	0.0	0.0	0.0	0.0	0.0	0.0	0.0	

Card 3            1            2            3            4            5            6            7            8

Variable	M42	M43	M44	M51	M52	M53	M54	
Type	F	F	F	F	F	F	F	
Default	0.0	0.0	0.0	0.0	0.0	0.0	0.0	

Card 4            1            2            3            4            5            6            7            8

Variable	M55	M61	M62	M63	M64	M65	M66	
Type	F	F	F	F	F	F	F	
Default	0.0	0.0	0.0	0.0	0.0	0.0	0.0	

**VARIABLE****DESCRIPTION**

EID	Element ID. A unique number is recommended. The nodes in a node set share the same element ID.
ID	Node ID or node set ID if the NODE_SET option is active. This is the node or node set to which the mass is assigned.
CID	Local coordinate ID which defines the orientation of the mass matrix
MIJ	The $IJ^{\text{th}}$ term of the symmetric mass matrix. The lower triangular part of the matrix is defined.

**\*ELEMENT\_MASS\_PART\_{OPTION}**

Available options include:

**<BLANK>**

**SET**

Purpose: Define additional non-structural mass to be distributed by an area (shell) / volume (solid) weighted distribution to all nodes of a given part ID. As an option, the total mass can be defined and the additional non-structural mass is computed. This option applies to all part ID's defined by shell and solid elements.

Card            1            2            3            4            5            6            7            8            9            10

Variable	ID	ADDMASS	FINMASS	LCID						
Type	I	F	F	I						
Default	none	0.	0.	0						

**VARIABLE****DESCRIPTION**

ID	Part or part set ID if the SET option is active. A unique number must be used.
ADDMASS	Added translational mass to be distributed to the nodes of the part ID or part set ID. Set to zero if FINMASS is nonzero. Since the additional mass is not included in the time step calculation of the elements in the PID or SID, ADDMASS must be greater than zero if FINMASS is zero.
FINMASS	Final translational mass of the part ID or part set ID. The total mass of the PID or SID is computed and subtracted from the final mass of the part or part set to obtain the added translational mass, which must exceed zero. Set FINMASS to zero if ADDMASS is nonzero. FINMASS is available in the R3 release of version 971.
LCID	Optional load curve ID to scale the added mass at time=0. This curve defines the scale factor as a function versus time. The curve must start at unity at t=0. This option applies to deformable bodies only.

**\*ELEMENT\_PLOTEL**

Purpose: Define a null beam element for visualization.

Card            1            2            3            4            5            6            7            8            9            10

Variable	EID	N1	N2							
Type	I	I	I							
Default	none	none	None							
Remarks	1									

<u>VARIABLE</u>	<u>DESCRIPTION</u>
EID	Element ID. A unique number must be used.
N1	Nodal point (end) 1.
N2	Nodal point (end) 2.

**Remarks:**

1. Part ID, 10000000, is assigned to PLOTEL elements.
2. PLOTEL element ID's must be unique with respect to other beam elements.

# \*ELEMENT

# \*ELEMENT\_SEATBELT

## \*ELEMENT\_SEATBELT

Purpose: Define a seat belt element.

Card            1            2            3            4            5            6            7            8            9            10

Variable	EID	PID	N1	N2	SBRID	SLEN	N3	N4	
Type	I	I	I	I	I	F	I	I	
Default	none	none	none	none	none	0.0	0	0	
Remarks					1	2	3		

### VARIABLE

### DESCRIPTION

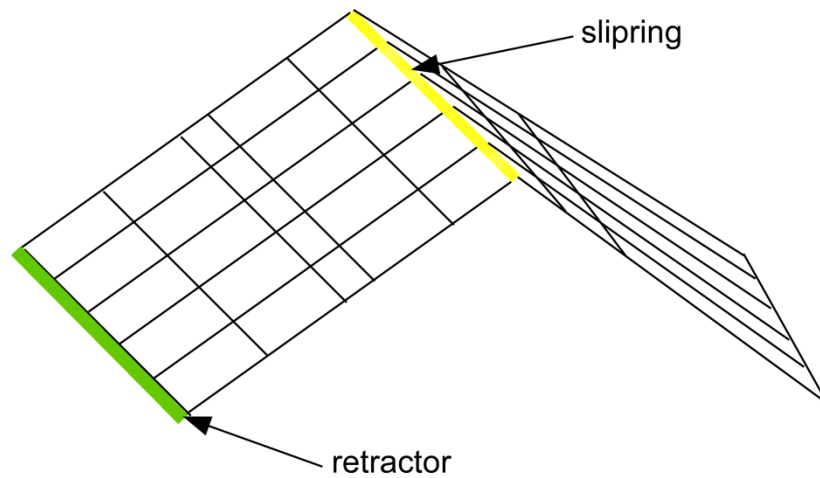
EID	Element ID. A unique number is required. Since null beams are created for visualization, this element ID should not be identical to element ID's defined for ELEMENT_BEAM and ELEMENT_DISCRETE.
PID	Part ID
N1	Node 1 ID
N2	Node 2 ID
SBRID	Retractor ID, see *ELEMENT_SEATBELT_RETRACTOR.
SLEN	Initial slack length
N3	Optional node 3 ID. When $N3 > 0$ and $N4 > 0$ , the elements becomes a shell seat belt element. The thickness of the shell seatbelt is defined in *SECTION_SHELL, not in *SECTION_SEATBELT. The shell-type seatbelt must be of a rectangular shape as shown in Figure 16.6 and contained in a logically regular mesh.
N4	Node 4 ID, which is required if and only if N3 is defined.

### Remarks:

1. The retractor ID should be defined only if the element is initially **inside** a retractor, see \*ELEMENT\_SEATBELT\_RETRACTOR.



2. Belt elements are single degree of freedom elements connecting two nodes. When the strain in an element is positive (i.e. the current length is greater then the unstretched length), a tension force is calculated from the material characteristics and is applied along the current axis of the element to oppose further stretching. The unstretched length of the belt is taken as the initial distance between the two nodes defining the position of the element plus the initial slack length.
  
3. Seatbelt shell elements are a new feature in version 971 and must be used with caution. The seatbelt shells distribute the loading on the surface of the dummy more realistically than the two node belt elements. For the seatbelt shells to work with sliprings and retractors it is necessary to use a logically regular mesh of quadrilateral elements. A seatbelt defined by a part ID must not be disjoint.



Top view:

RN5				SN5			
RE4			SRE14	SRE24			
RN4				SN4			
RE3			SRE13	SRE23			
RN3				SN3			
RE2			SRE12	SRE22			
RN2				SN2			
RE1			SRE11	SRE21			
RN1				SN1			

**Figure 16.6.** Definition of seatbelt shell elements. The ordering of the nodes and elements are important for seatbelt shells. See the input descriptions for SECTION\_SHELL, ELEMENT\_SEATBELT\_RETRACTOR and ELEMENT\_SEATBELT\_SLIPRING.

# \*ELEMENT

# \*ELEMENT\_SEATBELT\_ACCELEROMETER

## \*ELEMENT\_SEATBELT\_ACCELEROMETER

Purpose: Define seat belt accelerometer. The accelerometer is fixed to a rigid body containing the three nodes defined below. Whenever computed accelerations are compared to experimental results or whenever computed accelerations are compared between different runs, accelerometers are essential. Raw nodal accelerations contain considerable numerical noise and their comparisons are generally meaningless and, therefore, misleading.

Card            1            2            3            4            5            6            7            8

Variable	SBACID	NID1	NID2	NID3	IGRAV	INTOPT	MASS	
Type	I	I	I	I	I	I	F	
Default	0	0	0	0	0	0	0.	
Remarks								

### VARIABLE

### DESCRIPTION

SBACID	Accelerometer ID. A unique number must be used.
NID1	Node 1 ID
NID2	Node 2 ID
NID3	Node 3 ID
IGRAV	Gravitational accelerations due to body force loads. EQ.-6: Z and X components removed from acceleration output EQ.-5 Y and Z components removed from acceleration output EQ.-4: X and Y components removed from acceleration output EQ.-3: Z component removed from acceleration output EQ.-2: Y component removed from acceleration output EQ.-1: X component removed from acceleration output EQ. 0: all components included in acceleration output EQ. 1: all components removed from acceleration output

---

<u>VARIABLE</u>	<u>DESCRIPTION</u>
INTOPT	Integration option. If the accelerometer undergoes rigid body translation without rotation this option has no effect; however, if rotation occurs, option 1 may provide better agreement with the output of the accelerometer. EQ.0: velocities are integrated from the global accelerations and transformed into the local system of the accelerometer EQ.1: velocities are integrated directly from the local accelerations of the accelerometer.
MASS	Optional added mass for accelerometer. This mass is equally distributed to nodal points NID1, NID2, and NID3. This option avoids the need to use the *ELEMENT_MASS keyword input if additional mass is required.

**Remarks:**

The presence of the accelerometer means that the accelerations and velocities of node 1 will be output to **all** output files in local instead of global coordinates.

The local coordinate system is defined by the three nodes as follows:

- local **x** from node 1 to node 2,
- local **z** perpendicular to the plane containing nodes, 1, 2, and 3 ( $\mathbf{z} = \mathbf{x} \times \mathbf{a}$ ), where **a** is from node 1 to node 3),
- local **y** =  $\mathbf{z} \times \mathbf{x}$ .

The three nodes should all be part of the same rigid body. The local axis then rotates with the body.

# \*ELEMENT

## \*ELEMENT\_SEATBELT\_PRETENSIONER

### \*ELEMENT\_SEATBELT\_PRETENSIONER

Purpose: Define seat belt pretensioner. A combination with sensors and retractors is also possible.

Card 1            1            2            3            4            5            6            7            8

Variable	SBPRID	SBPRTY	SBSID1	SBSID2	SBSID3	SBSID4		
Type	I	I	I	I	I	I		
Default	0	0	0	0	0	0		
Remarks			1					

Card 2            1            2            3            4            5            6            7            8

Variable	SBRID	TIME	PTLCID	LMTFRC				
Type	I	F	I	F				
Default	0	0.0	0	0				
Remarks								

#### VARIABLE

#### DESCRIPTION

SBPRID

Pretensioner ID. A unique number has to be used.

---

<u>VARIABLE</u>	<u>DESCRIPTION</u>
SBPRTY	Pretensioner type (see Remark 2 below): EQ.1: pyrotechnic retractor with force limits, EQ.2: pre-loaded spring becomes active, EQ.3: lock spring removed, EQ.4: force versus time retractor. EQ.5: pyrotechnic retractor (old type in version 950) but with optional force limiter, LMTFRC. EQ.6: combination of types 4 and 5 as described in the notes below. EQ.7: independent pretensioner/retractor.
SBSID1	Sensor 1, see *ELEMENT_SEATBELT_SENSOR.
SBSID2	Sensor 2, see *ELEMENT_SEATBELT_SENSOR.
SBSID3	Sensor 3, see *ELEMENT_SEATBELT_SENSOR.
SBSID4	Sensor 4, see *ELEMENT_SEATBELT_SENSOR.
SBRID	Retractor number (SBPRTY = 1, 4, 5, or 6) or spring element number (SBPRTY = 2 or 3).
TIME	Time between sensor triggering and pretensioner acting.
PTLCID	Load curve for pretensioner (Time after activation, Pull-in) (SBPRTY = 1, 4, 5 or 6).
LMTFRC	Optional limiting force for retractor type 5. If zero, this option is ignored.

**Remarks:**

1. At least one sensor should be defined.

Pretensioners allow modeling of seven types of active devices which tighten the belt during the initial stages of a crash. Types 1 and 5 represent a pyrotechnic device which spins the spool of a retractor, causing the belt to be reeled in. The user defines a pull-in versus time curve which applies once the pretensioner activates. Types 2 and 3 represent preloaded springs or torsion bars which move the buckle when released. The pretensioner is associated with any type of spring element including rotational. Note that the preloaded spring, locking spring and any restraints on the motion of the associated nodes are defined in the normal way; the action of the pretensioner is merely to cancel the force in one spring until (or after) it fires. With the second type, the force in the spring element is canceled out until the pretensioner is activated. In this case the spring in question is normally a stiff, linear spring which acts as a locking mechanism, preventing

motion of the seat belt buckle relative to the vehicle. A preloaded spring is defined in parallel with the locking spring. This type avoids the problem of the buckle being free to 'drift' before the pretensioner is activated. Types 4, 6, and 7, force types, are described below.

To activate the pretensioner, the following sequence of events must occur:

1. Any one of up to four sensors must be triggered.
  2. Then a user-defined time delay occurs.
  3. Then the pretensioner acts.
2. In the 950 version of LS-DYNA, there are three types of seatbelt pretensioners that can be simulated. Types 2 and 3 are simple triggers for activating or deactivating springs, which then pull on the buckle. No changes have been made to these, and they are not discussed here. The type 1 pretensioner is intended to simulate a pyrotechnic retractor. The user inputs a load curve describing the pull-in of the pretensioner as a function of time. This pretensioner type interacts with the retractor, forcing it to pull in the amount of belt indicated. It works well, and does exactly what it says it will do, but it can be difficult to use in practice. The reason for this is that it has no regard for the forces being exerted on the belt. If a pull-in of 20mm is specified at a particular time, then 20mm of belt will be pulled in, even if this results in unrealistic forces in the seatbelt. Furthermore, there was no explicit way to turn this pretensioner off. Once defined, it overrode the retractor completely, and the amount of belt passing into or out of the retractor depended solely on the load curve specified.

In the 970 version of LS-DYNA, the behavior of the type 1 pretensioner was changed due to user feedback regarding these shortcomings. The behavior now is fundamentally simpler, though a bit confusing to explain. Each retractor has a loading (and optional unloading) curve that describes the force on the belt element as a function of the amount of belt that has been pulled out of the retractor since the retractor locked. The new type 1 pretensioner acts as a shift of this retractor load curve. An example will make this clear. Suppose at a particular time that 5mm of belt material has left the retractor. The retractor will respond with a force corresponding to 5mm pull-out on its loading curve. But suppose this retractor has a type 1 pretensioner defined, and at this instant of time the pretensioner specifies a pull-in of 20mm. The retractor will then respond with a force that corresponds to (5mm + 20mm) on its loading curve. This results in a much larger force. The effect can be that belt material will be pulled in, but unlike in the 950 version, there is no guarantee. The benefit of this implementation is that the force vs. pull-in load curve for the retractor is followed and no unrealistic forces are generated. Still, it may be difficult to produce realistic models using this option, so two new types of pretensioners have been added. These are available in 970 versions 1300 and later.

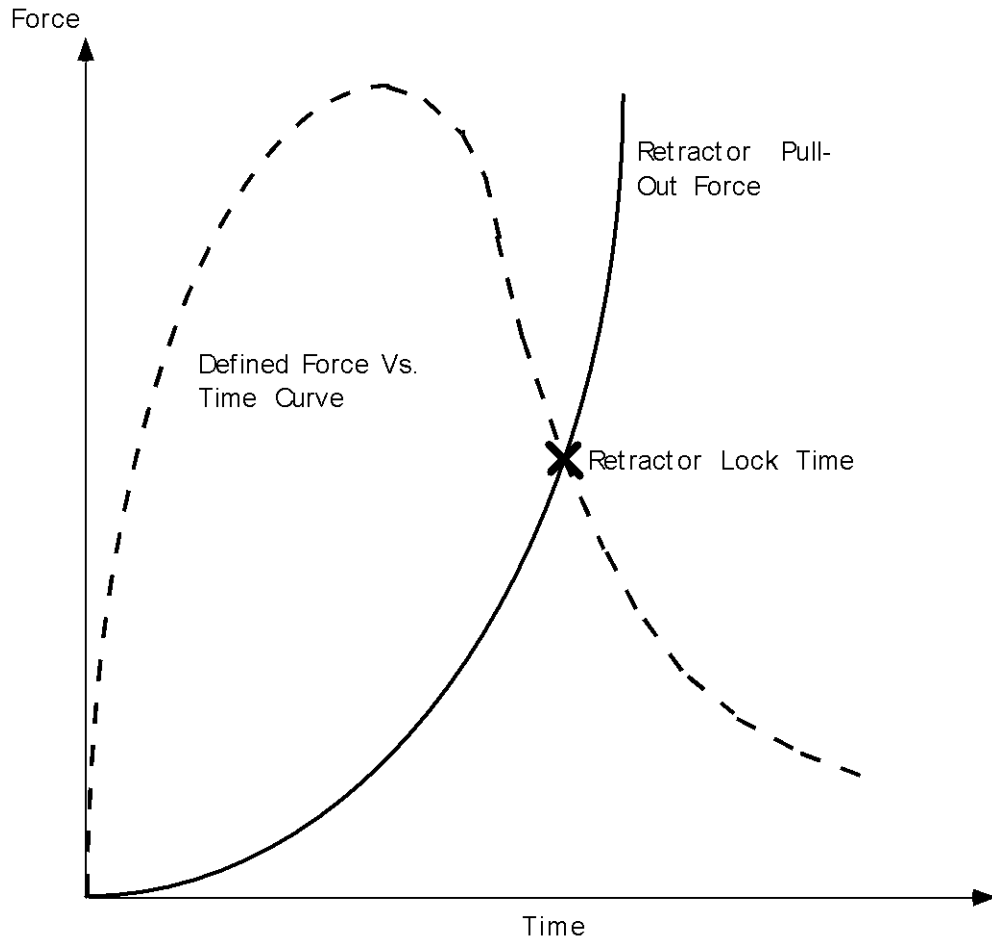
The type 4 pretensioner takes a force vs. time curve, See Figure 16.7. Each time step, the retractor computes the desired force without regard to the pretensioner. If the resulting force is less than that specified by the pretensioner load curve, then the pretensioner value is used instead. As time goes on, the pretensioner load curve should drop below the

forces generated by the retractor, and the pretensioner is then essentially inactive. This provides for good control of the actual forces, so no unrealistic values are generated. The actual direction and amount of belt movement is unspecified, and will depend on the other forces being exerted on the belt. This is suitable when the force the pretensioner exerts over time is known.

The type 5 pretensioner is essentially the same as the old type 1 pretensioner, but with the addition of a force limiting value. The pull-in is given as a function of time, and the belt is drawn into the retractor exactly as desired. However, if at any point the forces generated in the belt exceed the pretensioner force limit, then the pretensioner is deactivated and the retractor takes over. In order to prevent a large discontinuity in the force at this point, the loading curve for the retractor is shifted (in the abscissa) by the amount required to put the current (pull-out, force) on the load curve. For example, suppose the current force is 1000, and the current pull-out is -10 (10mm of belt has been pulled IN by the pretensioner). If the retractor would normally generate a force of 1000 after 25mm of belt had been pulled OUT, then the load curve is shifted to the left by 35, and remains that way for the duration of the calculation. So that at the current pull-in of 10, it will generate the force normally associated with a pull out of 25. If the belt reaches a pull out of 5, the force will be as if it were pulled out 40 (5 + the shift of 35), and so on. This option is included for those who liked the general behavior of the old type 1 pretensioner, but has the added feature of the force limit to prevent unrealistic behavior.

The type 6 pretensioner is a variation of the type 4 pretensioner, with features of the type 5 pretensioner. A force vs. time curve is input and the pretensioner force is computed each cycle. The retractor linked to this pretensioner should specify a positive value for PULL, which is the distance the belt pulls out before it locks. As the pretensioner pulls the belt into the retractor, the amount of pull-in is tracked. As the pretensioner force decreases and drops below the belt tension, belt will begin to move back out of the retractor. Once PULL amount of belt has moved out of the retractor (relative to the maximum pull in encountered), the retractor will lock. At this time, the pretensioner is disabled, and the retractor force curve is shifted to match the current belt tension. This shifting is done just like the type 5 pretensioner. It is important that a positive value of PULL be specified to prevent premature retractor locking which could occur due to small outward belt movements generated by noise in the simulation.

The type 7 pretensioner is a simple combination of retractor and pretensioner. It is similar to the type 6 except for the following changes: when the retractor locks, the pretensioner is NOT disabled – it continues to exert force according to the force vs. time curve until the end of the simulation. (The force vs. time curve should probably drop to 0 at some time.) Furthermore, the retractor load curve is not shifted – the retractor begins to exert force according to the force vs. pull-out curve. These two forces are added together and applied to the belt. Thus, the pretensioner and retractor are essentially independent.



**Figure 16.7.** Force versus time pretensioner. At the intersection, the retractor locks.



**\*ELEMENT\_SEATBELT\_RETRACTOR**

Purpose: Define seat belt retractor. See remarks below for seatbelt shell elements.

Card 1            1            2            3            4            5            6            7            8

Variable	SBRID	SBRNID	SBID	SID1	SID2	SID3	SID4	
Type	I	I	I	I	I	I	I	
Default	0	0	0	0	0	0	0	
Remarks		1,2	2	3				

Card 2            1            2            3            4            5            6            7            8

Variable	TDEL	PULL	LLCID	ULCID	LFED			
Type	F	F	I	I	F			
Default	0.0	0.0	0	0	0.0			
Remarks			4	5				

**VARIABLE**

**DESCRIPTION**

- SBRID            Retractor ID. A unique number has to be used.
- SBRNID         Retractor node ID
- SBID            Seat belt element ID
- SID1            Sensor ID 1
- SID2            Sensor ID 2
- SID3            Sensor ID 3

---

<u>VARIABLE</u>	<u>DESCRIPTION</u>
SID4	Sensor ID 4
TDEL	Time delay after sensor triggers.
PULL	Amount of pull-out between time delay ending and retractor locking, a length value.
LLCID	Load curve for loading (Pull-out, Force), see Figure 16.9.
ULCID	Load curve for unloading (Pull-out, Force), see Figure 16.9.
LFED	Fed length, see explanation below.

**Remarks:**

1. The retractor node should not be on any belt elements. The element defined should have one node coincident with the retractor node but should not be inside the retractor.
2. When  $SBRNID < 0$ , this retractor is for shell-type seatbelt,  $-SBRNID$  is the `*SET_NODE` containing RN1, RN2, ...RN5. SBID is then `*SET_SHELL_LIST`. Note that the numbering of  $-SBRNID$ , SBID has to be consistent in the direction of numbering. For example, if `*SET_NODE` for SBRNID has nodes of (RN1, RN2, RN3, RN4, RN5) then `*SET_SHELL_LIST` for SBID should have elem. of (RE1, RE2, RE3, RE4). See Figure 16.6.
3. At least one sensor should be defined.
4. The first point of the load curve should be  $(0, T_{min})$ .  $T_{min}$  is the minimum tension. All subsequent tension values should be greater than  $T_{min}$ .
5. The unloading curve should start at zero tension and increase monotonically (i.e., no segments of negative or zero slope).

Retractors allow belt material to be paid out into a belt element. Retractors operate in one of two regimes: unlocked when the belt material is paid out, or reeled in under constant tension and locked when a user defined force-pullout relationship applies.

The retractor is initially unlocked, and the following sequence of events must occur for it to become locked:

1. Any one of up to four sensors must be triggered. (The sensors are described below.)
2. Then a user-defined time delay occurs.

3. Then a user-defined length of belt must be paid out (optional).
4. Then the retractor locks and once locked, it remains locked.

In the unlocked regime, the retractor attempts to apply a constant tension to the belt. This feature allows an initial tightening of the belt and takes up any slack whenever it occurs. The tension value is taken from the first point on the force-pullout load curve. The maximum rate of pull out or pull in is given by  $0.01 \times \text{fed length}$  per time step. Because of this, the constant tension value is not always achieved.

In the locked regime, a user-defined curve describes the relationship between the force in the attached element and the amount of belt material paid out. If the tension in the belt subsequently relaxes, a different user-defined curve applies for unloading. The unloading curve is followed until the minimum tension is reached.

The curves are defined in terms of initial length of belt. For example, if a belt is marked at 10mm intervals and then wound onto a retractor, and the force required to make each mark emerge from the (locked) retractor is recorded, the curves used for input would be as follows:

- 0 Minimum tension (should be > zero)
- 10mm Force to emergence of first mark
- 20mm Force to emergence of second mark
- ..
- ..
- ..

Pyrotechnic pretensions may be defined which cause the retractor to pull in the belt at a predetermined rate. This overrides the retractor force-pullout relationship from the moment when the pretensioner activates.

If desired, belt elements may be defined which are initially inside the retractor. These will emerge as belt material is paid out, and may return into the retractor if sufficient material is reeled in during unloading.

Elements e2, e3 and e4 are initially inside the retractor, which is paying out material into element e1. When the retractor has fed  $L_{\text{crit}}$  into e1, where

$$L_{\text{crit}} = \text{fed length} - 1.1 \times \text{minimum length}$$

(minimum length defined on belt material input)

(fed length defined on retractor input)

Element e2 emerges with an unstretched length of  $1.1 \times$  minimum length; the unstretched length of element e1 is reduced by the same amount. The force and strain in e1 are unchanged; in e2, they are set equal to those in e1. The retractor now pays out material into e2.

If no elements are inside the retractor, e2 can continue to extend as more material is fed into it.

As the retractor pulls in the belt (for example, during initial tightening), if the unstretched length of the mouth element becomes less than the minimum length, the element is taken into the retractor.

To define a retractor, the user enters the retractor node, the 'mouth' element (into which belt material will be fed), e1 in Figure 16.8, up to 4 sensors which can trigger unlocking, a time delay, a payout delay (optional), load and unload curve numbers, and the fed length. The retractor node is typically part of the vehicle structure; belt elements should not be connected to this node directly, but any other feature can be attached including rigid bodies. The mouth element should have a node coincident with the retractor but should not be inside the retractor. The fed length would typically be set either to a typical element initial length, for the distance between painted marks on a real belt for comparisons with high speed film. The fed length should be at least three times the minimum length.

If there are elements initially inside the retractor (e2, e3 and e4 in the Figure 16.8) they should not be referred to on the retractor input, but the retractor should be identified on the element input for these elements. Their nodes should all be coincident with the retractor node and should not be restrained or constrained. Initial slack will automatically be set to  $1.1 \times$  minimum length for these elements; this overrides any user-defined value.

Webblockers can be included within the retractor representation simply by entering a 'locking up' characteristic in the force pullout curve, see Figure 16.9. The final section can be very steep (but must have a finite slope).

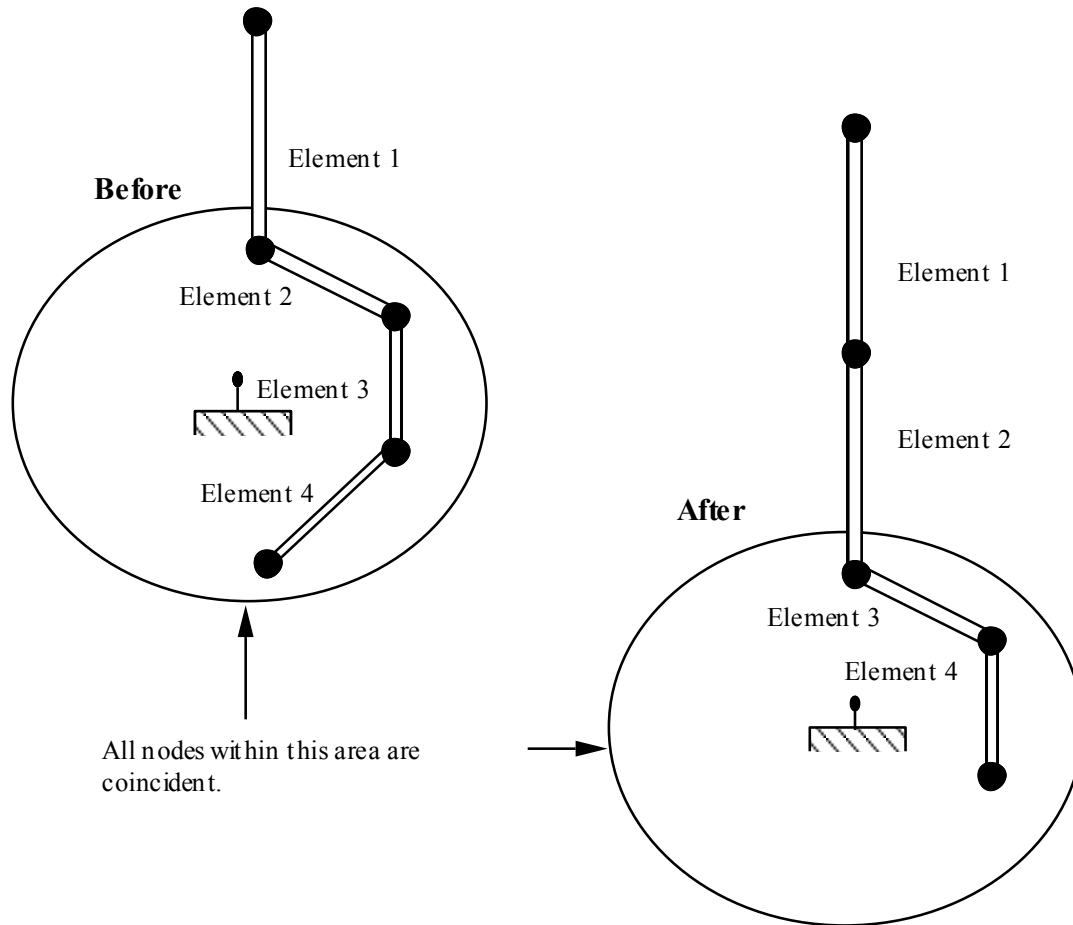
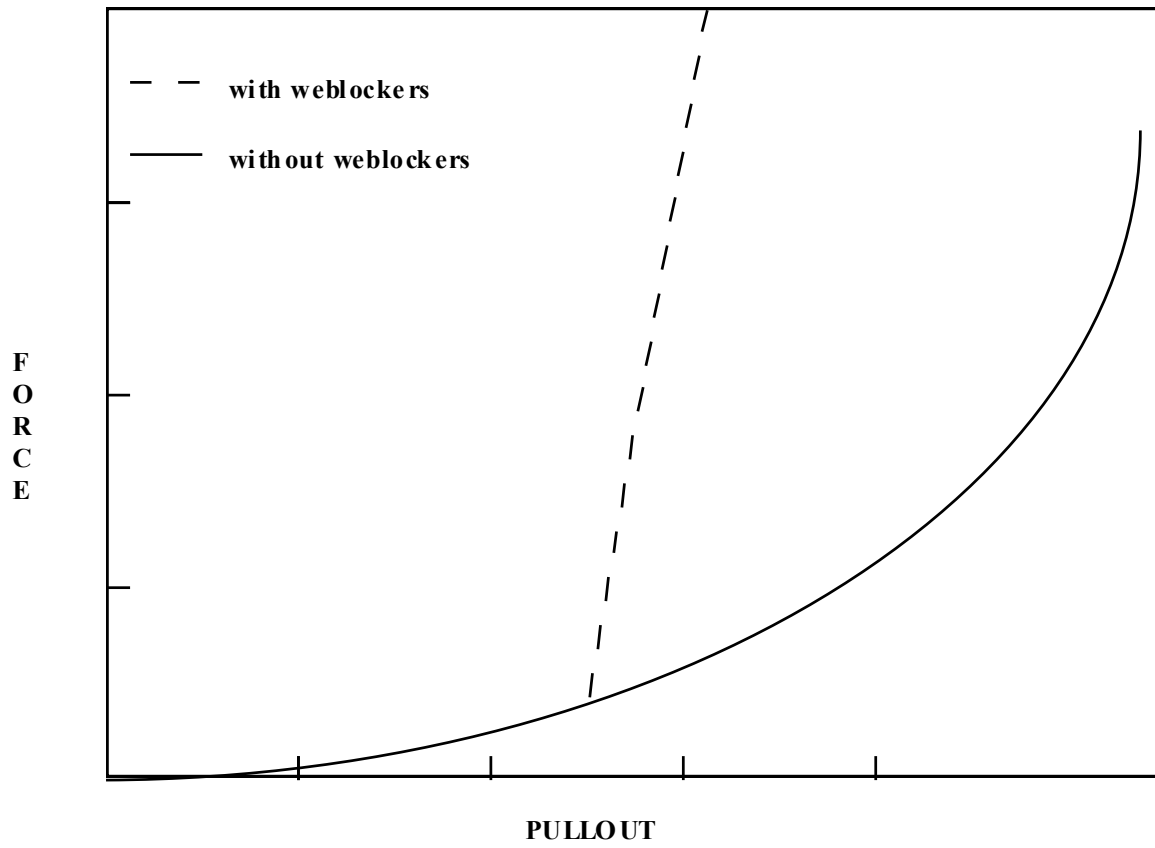


Figure 16.8. Elements in a retractor.



**Figure 16.9.** Retractor force pull characteristics.

**\*ELEMENT\_SEATBELT\_SENSOR**

Purpose: Define seat belt sensor. Four types are possible, see explanation below.

Card 1            1            2            3            4            5            6            7            8

Variable	SBSID	SBSTYP	SBSFL					
Type	I	I	I					
Default	0	0	0					
Remarks								

**Card 2 if SBSTYP=1**

Card 2            1            2            3            4            5            6            7            8

Variable	NID	DOF	ACC	ATIME				
Type	I	I	F	F				
Default	0	0	0.0	0.0				
Remarks	1							

**\*ELEMENT****\*ELEMENT\_SEATBELT\_SENSOR****Card 2 if SBSTYP=2**

Card 2            1            2            3            4            5            6            7            8

Variable	SBRID	PULRAT	PULTIM					
Type	I	F	F					
Default	0	0.0	0.0					
Remarks								

**Card 2 if SBSTYP=3**

Card 2            1            2            3            4            5            6            7            8

Variable	TIME							
Type	F							
Default	0.0							
Remarks								

**Card 2 if SBSTYP=4**

Card 2            1            2            3            4            5            6            7            8

Variable	NID1	NID2	DMX	DMN				
Type	I	I	F	F				
Default	0	0	0.0	0.0				
Remarks			2	2				



---

<u>VARIABLE</u>	<u>DESCRIPTION</u>
SBSID	Sensor ID. A unique number has to be used.
SBSTYP	Sensor type: EQ.1: acceleration of node, EQ.2: retractor pull-out rate, EQ.3: time, EQ.4: distance between nodes.
SBSFL	Sensor flag: EQ.0: sensor active during dynamic relaxation, EQ.1: sensor can be triggered during dynamic relaxation.
NID	Node ID of sensor
DOF	Degree of freedom: EQ.1: x, EQ.2: y, EQ.3: z.
ACC	Activating acceleration
ATIME	Time over which acceleration must be exceeded
SBRID	Retractor ID, see *ELEMENT_SEATBELT_RETRACTOR.
PULRAT	Rate of pull-out (length/time units)
PULTIM	Time over which rate of pull-out must be exceeded
TIME	Time at which sensor triggers
NID1	Node 1 ID
NID2	Node 2 ID
DMX	Maximum distance
DMN	Minimum distance

**Remarks:**

1. Node should not be on rigid body, velocity boundary condition, or other 'imposed motion' feature.
2. Sensor triggers when the distance between the two nodes is  $d \geq d_{\max}$  or  $d \leq d_{\min}$ .

Sensors are used to trigger locking of retractors and activate pretensioners. Four types of sensors are available which trigger according to the following criteria:

**Type 1** – When the magnitude of x-, y-, or z- acceleration of a given node has remained above a given level continuously for a given time, the sensor triggers. This does not work with nodes on rigid bodies.

**Type 2** – When the rate of belt payout from a given retractor has remained above a given level continuously for a given time, the sensor triggers.

**Type 3** – The sensor triggers at a given time.

**Type 4** – The sensor triggers when the distance between two nodes exceeds a given maximum or becomes less than a given minimum. This type of sensor is intended for use with an explicit mass/spring representation of the sensor mechanism.

By default, the sensors are inactive during dynamic relaxation. This allows initial tightening of the belt and positioning of the occupant on the seat without locking the retractor or firing any pretensioners. However, a flag can be set in the sensor input to make the sensors active during the dynamic relaxation phase.

**\*ELEMENT\_SEATBELT\_SLIPRING**

Purpose: Define seat belt slip ring.

Card            1            2            3            4            5            6            7            8

Variable	SBSRID	SBID1	SBID2	FC	SBRNID	LTIME	FCS	ONID
Type	I	I	I	F	I	F	F	I
Default	0	0	0	0.0	0	1.0E20	0.0	0

**Optional Card 2**

Card 2            1            2            3            4            5            6            7            8

Variable	K	FUNCID	DIRECT	DC		LCNFFD	LCNFFS	
Type	F	I	I	F		I	I	
Default	0.	0	0	0		0	0	

<u>VARIABLE</u>	<u>DESCRIPTION</u>
SBSRID	Slipring ID. A unique number has to be used. See remarks below for the treatment of sliprings for shell belt elements.
SBID1	Seat belt element 1 ID
SBID2	Seat belt element 2 ID
FC	Coulomb dynamic friction coefficient. If less than zero,  FC  refers to a curve which defines the dynamic friction coefficient as a function of time.
SBRNID	Slip ring node, NID
LTIME	Slip ring lockup time. After this time no material is moved from one side of the slip ring to the other. This option is not active during dynamic relaxation.

<b>VARIABLE</b>	<b>DESCRIPTION</b>
FCS	Optional Coulomb static friction coefficient. . If less than zero,  FCS  refers to a curve which defines the static friction coefficient as a function of time.
ONID	Optional orientation node ID.
K	Optional coefficient for determining the Coulomb friction coefficient related to angle alpha
FUNCID	Function ID to determine friction coefficient.
DIRECT	Direction of belt movement: EQ. 0: if the belt can move along both directions. EQ.12: if the belt is only allowed to slip along the direction from SBID1 to SBID2 EQ.21: if the belt is only allowed to slip along the direction from SBID2 to SBID
DC	Optional decay constant to allow a smooth transition between the static and dynamic friction coefficients, i.e., $\mu_c = FC + (FCS - FC) e^{-DC \cdot  v_{rel} }$
LCNFFD	Optional curve for normal-force-dependent Coulomb dynamic friction coefficient. When defined, the dynamic friction coefficient becomes $FC + f_{LCNFFD}(F_n)$ , where $f_{LCNFFD}(F_n)$ is the function value of LCNFFD when contact force equals $F_n$
LCNFFS	Optional curve for normal-force-dependent Coulomb static friction coefficient. When defined, the static friction coefficient becomes $FCS + f_{LCNFFS}(F_n)$ , where $f_{LCNFFS}(F_n)$ is the function value of LCNFFS when contact force equals $F_n$

**Remarks:**

When SBRNID<0, this slipping is for shell-type seatbelt, -SBRNID is the \*SET\_NODE containing SN1, SN2, ...SN5. SBID1 and SBID2 are then \*SET\_SHELL\_LIST. Note that the numbering of -SBRNID, SBID1 and SBID2 has to be consistent in the direction of numbering. For example if, \*SET\_NODE for SBRNID has nodes of (SN1, SN2, SN3, SN4, SN5) then \*SET\_SHELL\_LIST for SBID1 should have elem. of (SRE11, SRE12, SRE13, SRE14) and \*SET\_SHELL\_LIST for SBID2 should have elem. of (SRE21, SRE22, SRE23, SRE24). See Figure 16.6.

Elements 1 and 2 should share a node which is coincident with the slip ring node. The slip ring node should not be on any belt elements.

Sliprings allow continuous sliding of a belt through a sharp change of angle. Two elements (1 & 2 in Figure 16.10) meet at the slipring. Node B in the belt material remains attached to the slipring node, but belt material (in the form of unstretched length) is passed from element 1 to element 2 to achieve slip. The amount of slip at each time step is calculated from the ratio of forces in elements 1 and 2. The ratio of forces is determined by the relative angle between elements 1 and 2 and the coefficient of friction, FC. The tension in the belts are taken as  $T_1$  and  $T_2$ , where  $T_2$  is on the high tension side and  $T_1$  is the force on the low tension side. Thus, if  $T_2$  is sufficiently close to  $T_1$ , no slip occurs; otherwise, slip is just sufficient to reduce the ratio  $T_2/T_1$  to  $e^{FC \cdot \theta}$ , where  $\theta$  is the wrap angle, see Figures 16.11 and 16.12. No slip occurs if both elements are slack. The out-of-balance force at node B is reacted on the slipring node; the motion of node B follows that of slipring node.

If, due to slip through the slipring, the unstretched length of an element becomes less than the minimum length (as entered on the belt material card), the belt is remeshed locally: the short element passes through the slipring and reappears on the other side (see Figure 16.10). The new unstretched length of e1 is  $1.1 \times$  minimum length. Force and strain in e2 and e3 are unchanged; force and strain in e1 are now equal to those in e2. Subsequent slip will pass material from e3 to e1. This process can continue with several elements passing in turn through the slipring.

To define a slipring, the user identifies the two belt elements which meet at the slipring, the friction coefficient, and the slipring node. The two elements must have a common node coincident with the slipring node. No attempt should be made to restrain or constrain the common node for its motion will automatically be constrained to follow the slipring node. Typically, the slipring node is part of the vehicle body structure and, therefore, belt elements should not be connected to this node directly, but any other feature can be attached, including rigid bodies.

If K is undefined, the limiting force ratio is taken as  $e^{FC \cdot \theta}$ . If K is defined, the maximum force ratio is computed as

$$e^{FC \cdot \theta (1 + K \cdot \alpha^2)}$$

where alpha is the angle shown in Figure 16.13. If FUNCID is specified, the coefficients FC, FCS, and K are not used. The function is defined using the \*DEFINE\_FUNCTION keyword input. This function is a function of two variables, and the ratio is given by evaluating

$$\frac{T_2}{T_1} = \text{FUNC}(\theta, \alpha)$$

For example, the default behavior can be obtained using the function definition (assuming FC has a value of 0.025 and the function ID is unity)

\*DEFINE\_FUNCTION

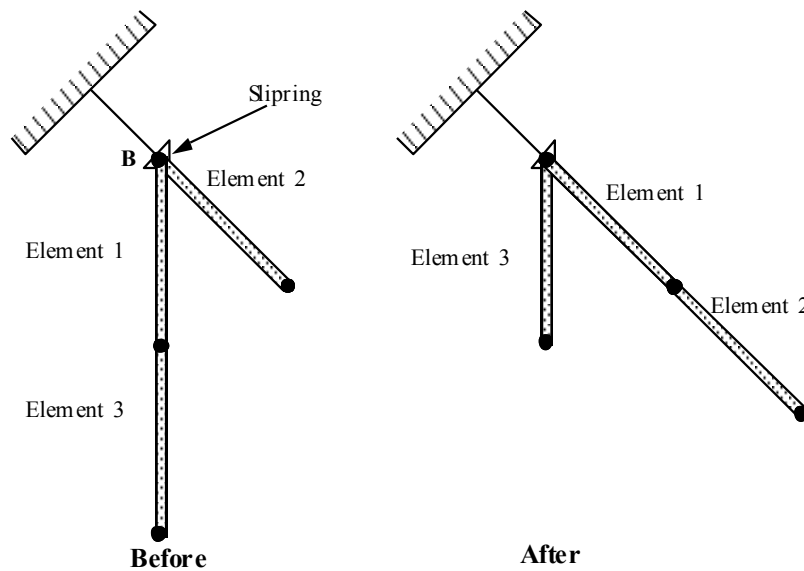
1,

f(theta,alpha) = exp(0.025\*theta)

Behavior like default option can be obtained with (K=0.1):

\*DEFINE\_FUNCTION

1,  
f(theta,alpha) = exp(0.025\*theta\*(1.+0.1\*alpha\*alpha))



**Figure 16.10.** Elements passing through slipping.

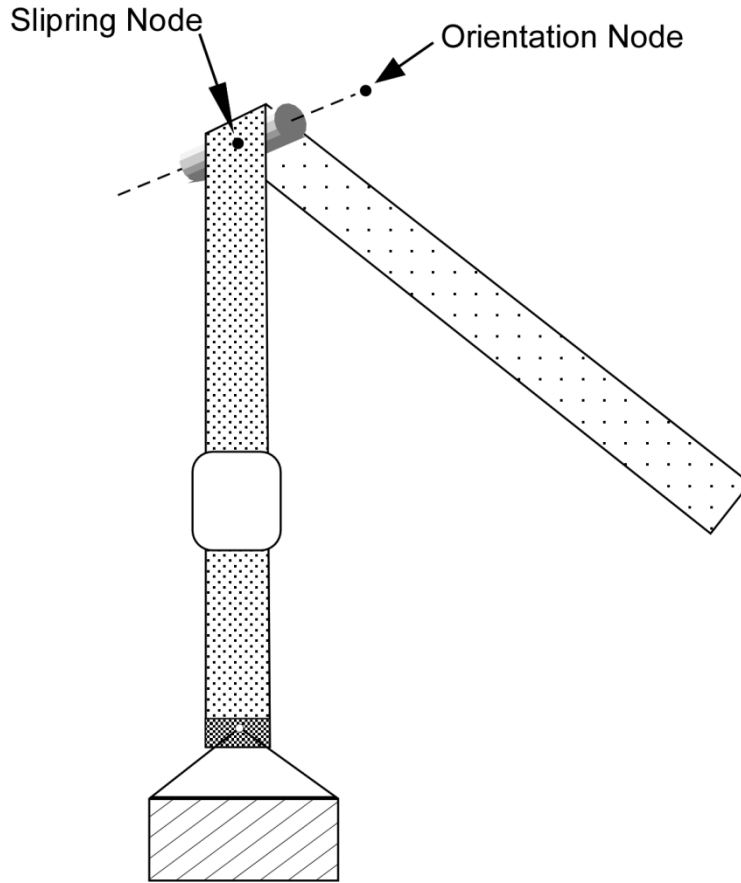


Figure 16.11. Orientation node.

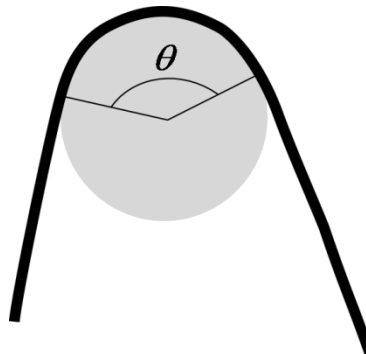
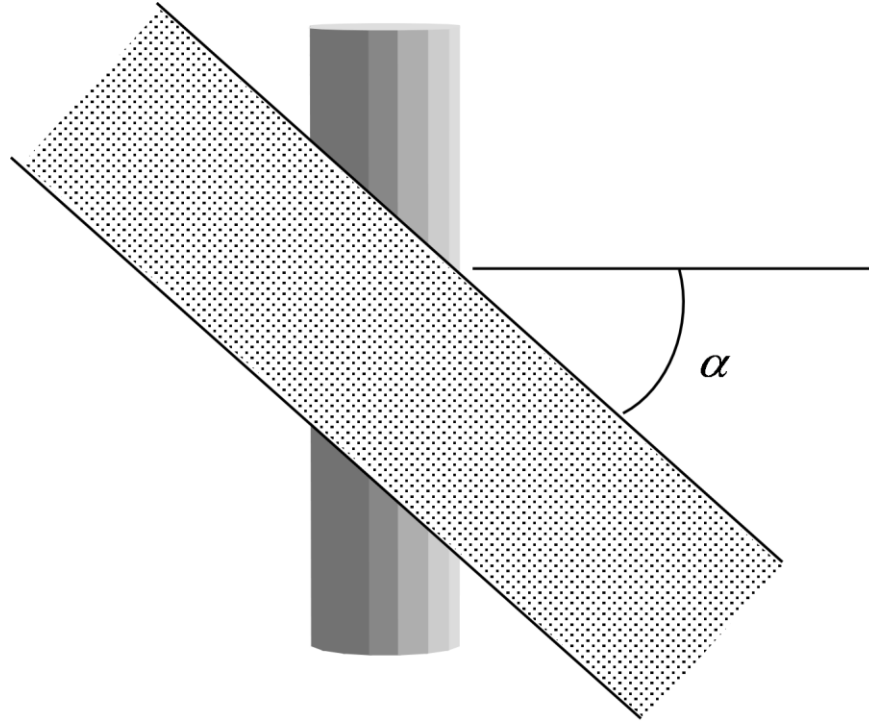


Figure 16.12. Front view showing wrap angle.



**Figure 16.13.** Top view shows orientation of belt relative to axis.



**\*ELEMENT\_SHELL\_{OPTION}**

Available options include:

**<BLANK>**

**THICKNESS**

**BETA or MCID**

**OFFSET**

**DOF**

**COMPOSITE**

Purpose: Define three, four, six, and eight node elements including 3D shells, membranes, 2D plane stress, plane strain, and axisymmetric solids. The type of the element and its formulation is specified through the part ID (see \*PART) and the section ID (see \*SECTION\_SHELL). Also, the thickness of each element can be specified when applicable on the element cards or else a default thickness value is used from the section definition. For orthotropic and anisotropic materials a local material angle (variable BETA) can be defined which is cumulative with the integration point angles specified in \*SECTION\_SHELL. Alternatively, the angle BETA can be determined by defining a local coordinate system, MCID. An offset option is available for moving the shell reference surface from the nodal points that define the shell. The COMPOSITE option allows an arbitrary number of integration points across the shell thickness of shells sharing the same part ID. This is independent of thickness defined in \*SECTION\_SHELL.

For the shell formulation that uses additional nodal degrees-of-freedom, the option DOF is available to connect the nodes of the shell to corresponding scalar nodes. Four scalar nodes are required for element type 25 to model the thickness changes that require 2 additional degrees-of-freedom per shell node. Defining these nodes is optional, if left undefined, they will be automatically created.

**\*ELEMENT****\*ELEMENT\_SHELL**

Card 1            1            2            3            4            5            6            7            8            9            10

Variable	EID	PID	N1	N2	N3	N4	N5	N6	N7	N8
Type	I	I	I	I	I	I	I	I	I	I
Default	none	none	none	none	none	none	0	0	0	0
Remarks			3	3	3	3				

**Optional Card (Required if THICKNESS or BETA is specified after the keyword)**

Card            1            2            3            4            5            6            7            8            9            10

Variable	THIC1	THIC2	THIC3	THIC4	BETA or MCID
Type	F	F	F	F	F
Default	0.	0.	0.	0.	0.
Remarks	1				2

**Optional Card (Required if OFFSET is specified after the keyword)**

Card            1            2            3            4            5            6            7            8            9            10

Variable	OFFSET				
Type	F				
Default	0.				
Remarks	7				

**Optional Card for scalar nodes (Required if DOF is specified after the keyword)**

Card            1            2            3            4            5            6            7            8            9            10

Variable			NS1	NS2	NS3	NS4				
Type			I	I	I	I				
Default										
Remarks			8	8	8	8				

**Optional Card (Required if COMPOSITE is specified)**

The material ID, thickness, and material angle for each through-thickness integration point of a composite shell are provided below (up to two integration points per card). The integration point data should be given sequentially starting with the bottommost integration point. The total number of integration points is determined by the number of entries on these cards. The thickness of each shell is the summation of the integration point thicknesses. Define as many cards as needed.

Card            1            2            3            4            5            6            7            8

Variable	MID1	THICK1	B1		MID2	THICK2	B2	
Type	I	F	F		I	F	F	

Cards            1            2            3            4            5            6            7            8

Variable	MID3	THICK3	B3		Etc.			
Type	I	F	F		I	F	F	

**VARIABLE****DESCRIPTION**

EID            Element ID. Chose a unique number with respect to other elements.

PID            Part ID, see \*PART.

---

<b>VARIABLE</b>	<b>DESCRIPTION</b>
N1	Nodal point 1
N2	Nodal point 2
N3	Nodal point 3
N4	Nodal point 4
N5-N8	Mid-side nodes for eight node shell
THIC1	Shell thickness at node 1
THIC2	Shell thickness at node 2
THIC3	Shell thickness at node 3
THIC4	Shell thickness at node 4
BETA	Orthotropic material base offset angle (see remarks 2 and 6 below). The angle is given in degrees. If blank the default is set to zero.
MCID	Material coordinate system ID. The angle BETA is taken as the angle from the element local x-axis (N1-to-N2) to the projection of the x-axis of the local coordinate system, MCID, onto the surface of the shell element.
OFFSET	The offset distance from the plane of the nodal points to the reference surface of the shell in the direction of the normal vector to the shell.
NS1	Scalar node 1, parameter NDOF on the *NODE_SCALAR is normally set to 2. If the thickness is constrained, set NDOF=0.
NS2	Scalar node 2
NS3	Scalar node 3
NS4	Scalar node 4
MID <sub>i</sub>	Material ID of integration point i, see *MAT_.... Section.
THICK <sub>i</sub>	Thickness of integration point i.
B <sub>i</sub>	Material angle of integration point i.

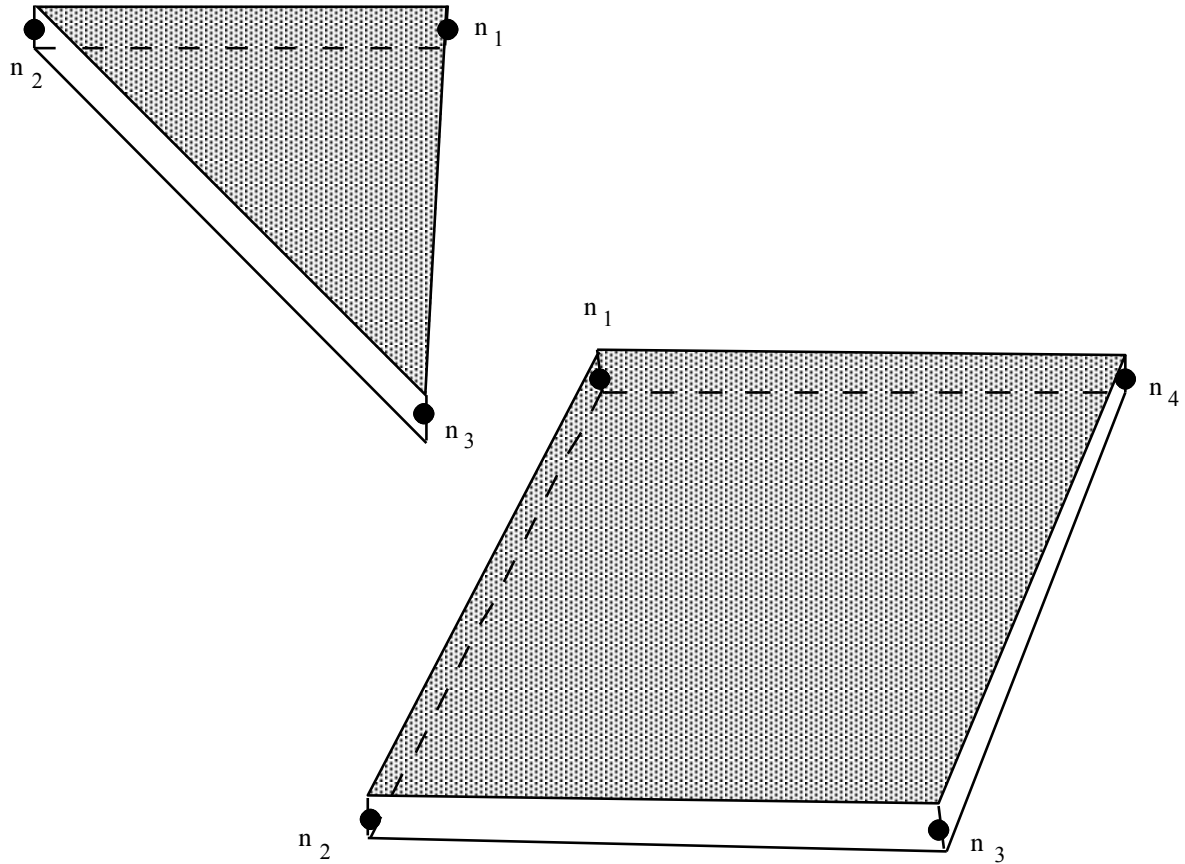
**Remarks:**

1. Default values in place of zero shell thicknesses are taken from the cross-section property definition of the PID, see \*SECTION\_SHELL.
2. BETA is defined only for orthotropic and anisotropic materials.
3. Counterclockwise node numbering determines the top surface, see Figure 16.14.
4. Stresses and strain output in the binary databases are by default given in the global coordinate system. Stress resultants are output in the local coordinate system for the shell element.
5. Interior angles must be less than 180 degrees.
6. To allow for an arbitrary orientation of the shell elements within the finite element mesh, each ply in the composite can have a unique material orientation angle which measures the offset from a reference system in the element. The reference system is determined by the AOPT and associated parameters in the \*MAT input. The total offset for the  $i$ 'th integration point through the element thickness consists of two parts, the base offset and the layer offset. We write this as

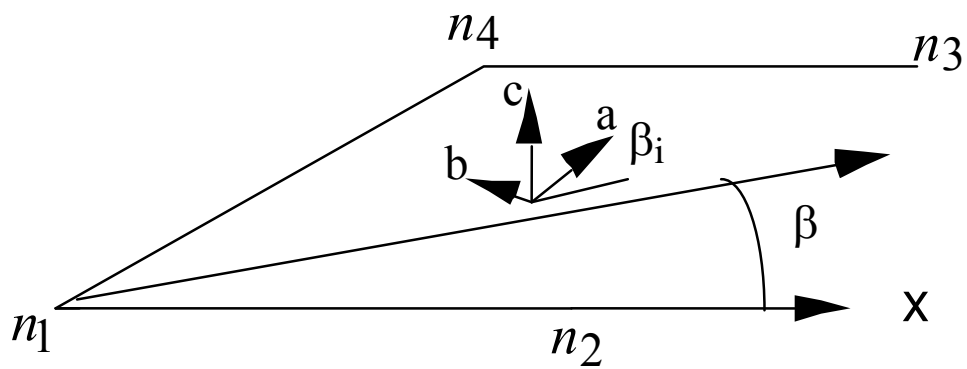
$$\theta_i = \beta + \beta_i$$

where  $\beta$  is the base offset and  $\beta_i$  is the layer offset. The element BETA input here overrides the BETA on \*MAT input. The  $\beta_i$  angles are input either by \*PART\_COMPOSITE, or by using the ICOMP option on \*SECTION\_SHELL. Figures 16.15 and 16.16 depict these angles.

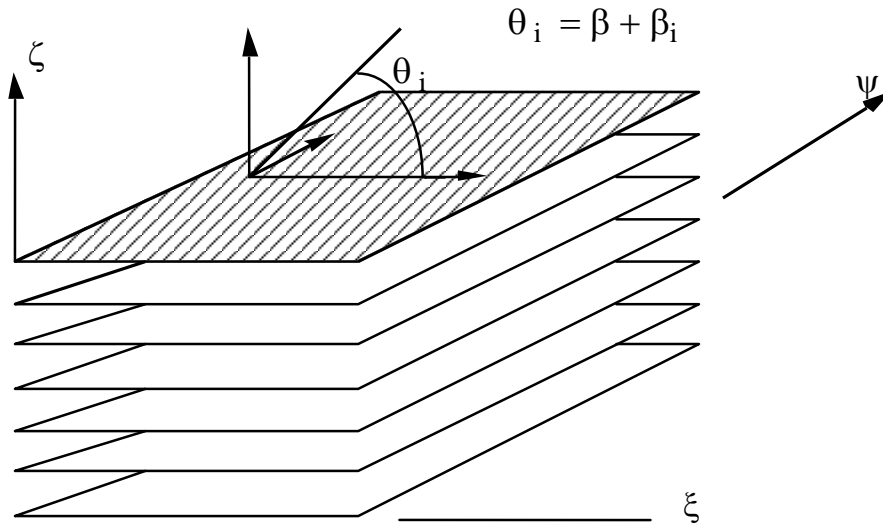
7. The parameter OFFSET gives the offset from the nodal points of the shell to the reference surface. This option applies to most shell formulations excluding two-dimensional elements, membrane elements, and quadratic shell elements. The reference surface offset given by OFFSET is not taken into account in the contact subroutines unless CNTCO is set to 1 in \*CONTROL\_SHELL.
8. The scalar nodes specified on the optional card refer to the scalar nodes defined by the user to hold additional degrees of freedom for shells with this capability. Scalar nodes are used with shell element type 25 and 26.



**Figure 16.14.** LS-DYNA shell elements. Counterclockwise node numbering determines the top surface.



**Figure 16.15.** Orientation of material directions (shown relative to the 1-2 side as when AOPT=0 in \*MAT).



**Figure 16.16.** A multi-layer laminate can be defined. The angle  $\beta_i$  is defined for the  $i$ 'th lamina (integration point), see \*SECTION\_SHELL.

# \*ELEMENT

# \*ELEMENT\_SHELL\_NURBS\_PATCH

## \*ELEMENT\_SHELL\_NURBS\_PATCH

Purpose: Define a NURBS-surface element (patch) based on a rectangular grid of control points. This grid consists of  $NPR \times NPS$  control points, where NPR and NPS are the number of control points in local r- and s-direction, respectively. The necessary shape functions are defined through two knot-vectors:

Knot-Vector in r-direction with length  $NPR+PR+1$  and

Knot-Vector in s-direction with length  $NPS+PS+1$

There is no limit on the size of the underlying grid to define a NURBS-surface element, so the total number of necessary Keyword-cards ( $2+NA+NB+NC+(\text{optional: } ND)$ ) depends on the parameters given in the first card.

An example of a keyword definition is given in Figure 16.17.

### Card Format (8I10)

Card 1            1            2            3            4            5            6            7            8

Variable	NPID	PID	NPR	PR	NPS	PS		
Type	I	I	I	I	I	I		
Default	none	none	none	none	None	none		

Card 2            1            2            3            4            5            6            7            8

Variable	WFL	FORM	INT	NISR	NISS	IMASS		
Type	I	I	I	I	I	I		
Default	0	0	0	PR	PS	0		
Remarks				see Figure 16.17	see Figure 16.17			



The knot-vector in local r-direction with length  $LA=NPR+PR+1$  is given below (up to eight values per card). Number of cards necessary:  $NA=(LA+7)/8$

Cards A            1            2            3            4            5            6            7            8

Variable	RK1	RK2	RK3	RK4	RK5	RK6	RK7	RK8
Type	F	F	F	F	F	F	F	F
Default	none	none	none	none	none	none	none	none

The knot-vector in local s-direction with length  $LB=NPS+PS+1$  is given below (up to eight values per card). Number of cards necessary:  $NB=(LB+7)/8$

Cards B            1            2            3            4            5            6            7            8

Variable	SK1	SK2	SK3	SK4	SK5	SK6	SK7	SK8
Type	F	F	F	F	F	F	F	F
Default	none	none	none	none	none	none	none	none

The connectivity of the control grid will be defined in NPS rows of NPR control points, where one row is given in one set of C-cards with length  $LC=NPR$  (up to eight values per card).

Number of C-cards per row necessary:  $NC=(LC+7)/8$

Total number of C-cards:  $NCT=NPS*NC$

To define the whole control net, NPS sets of C-cards need to be defined.

(for further demonstration see Figure 16.17)

Cards C            1            2            3            4            5            6            7            8

Variable	N1	N2	N3	N4	N5	N6	N7	N8
Type	I	I	I	I	I	I	I	I
Default	none	none	none	none	none	none	none	none

**Optional Cards (Required if WFL.ne.0)**

The weights of the control points are specified below. They have to be set up in the same structure as the definition of the connectivity (see Figure 16.17), that is in NPS rows of NPR control points, where one row is given in one set of D-cards with length LD=LC (up to eight values per card).

Number of D-cards per row necessary: ND=NC

Total number of D-cards: NDT=NTC

To define the whole control net, NPS sets of D-cards need to be defined.

Cards D            1            2            3            4            5            6            7            8

Variable	W1	W2	W3	W4	W5	W6	W7	W8
Type	F	F	F	F	F	F	F	F
Default	none	none	none	none	none	none	none	none

<u>VARIABLE</u>	<u>DESCRIPTION</u>
-----------------	--------------------

NPID	Nurbs-Patch Element ID. A unique number has to be chosen
PID	Part ID, see *PART.
NPR	Number of control points in local r-direction.
PR	Order of polynomial of univariate nurbs basis functions in local r-direction.
NPS	Number of control points in local s-direction.
PS	Order of polynomial of univariate nurbs basis functions in local s-direction.
WFL	Flag for weighting factors of the control points EQ.0: all weights at the control points are set to 1.0 (B-spline basis) and no optional cards D are allowed NE.0: the weights at the control points are defined in optional cards D which must be defined after cards C.
FORM	Shell formulation to be used EQ.0: shear deformable shell theory with rotational DOFs EQ.1: shear deformable shell theory without rotational DOFs EQ.2: thin shell theory without rotational DOFs EQ.3: thin shell theory with rotational DOFs

---

<u>VARIABLE</u>	<u>DESCRIPTION</u>
	EQ.4: combination of FORM=0 and FORM=1 (see remark 3)
INT	In-plane numerical integration rule. EQ.0: uniformly reduced Gauss integration (NIP=PR*PS) NE.0: full Gauss integration (NIP=(PR+1)*(PS+1)).
NISR	Number of (automatically created) Interpolation Shell elements in local r-direction per created Nurbs-element for visualization (postprocessing) and contact (see remark 4 and Figure 16.17).
NISS	Number of (automatically created) Interpolation Shell elements in local s-direction per created Nurbs-element for visualization (psotprocessing) and contact (see remark 4 and Figure 16.17).
IMASS	Option for lumping of mass matrix: EQ.0: row sum EQ.1: diagonal weighting.
RK <sub>i</sub>	Values of the univariate knot vector in local r-direction defined in cards A.
SK <sub>i</sub>	Values of the univariate knot vector in local s-direction defined in cards B.
N <sub>i</sub>	Control points i (defined via *NODE) to define the control grid in cards C. LT.0 (FORM=4): control point with rotational DOFs (6 DOFs/control point, see remark 3)
W <sub>i</sub>	Weighting factors of the control point i defined in cards D.

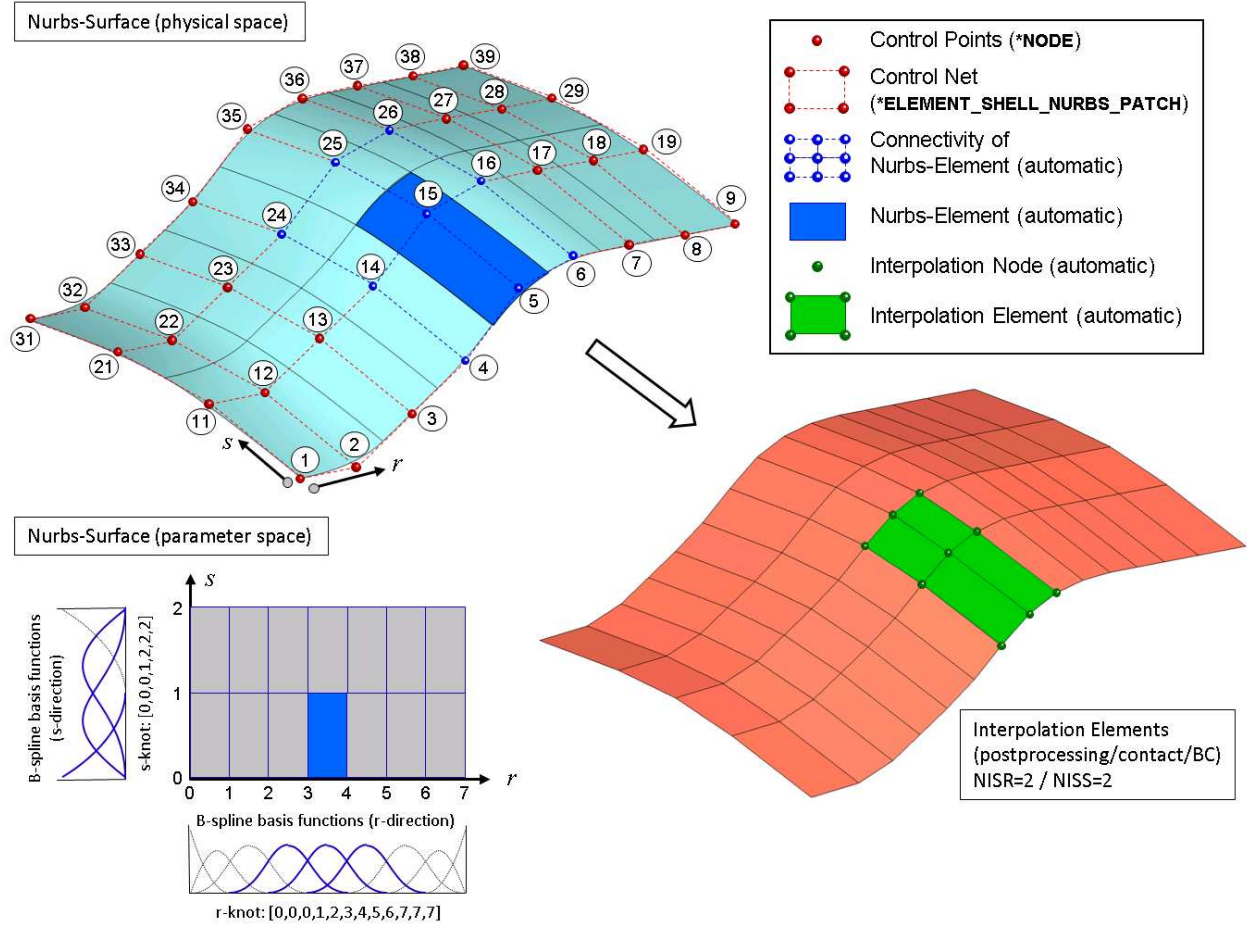
**Remarks:**

1. The thickness of the shell is defined in \*SECTION\_SHELL (referenced via \*PART).
2. ELFORM=201 has to be used in \*SECTION\_SHELL.
3. FORM=4 allows the mixture of control points with and without rotational DOFs. This might be useful at the boundaries of Nurbs-patches where the continuity usually drops to C<sup>0</sup> and rotational DOFs are necessary. To indicate control points with rotational DOFs (6 DOFs/control point), the node number of the corresponding control point has to be set as the negative node ID in the connectivity cards C. Positive node IDs indicate control points without rotational DOFs (3 DOFs/control point).
4. The post-processing and the treatment of contact boundary conditions are presently dealt with interpolation elements, defined via interpolation nodes. These nodes and elements are automatically created, where NISR and NISS indicate the number of interpolation

elements to be created per NURBS-element in the local r- and s-direction, respectively (see Figure 16.17).

```

*ELEMENT_SHELL_NURBS_PATCH
$ Card 1
$----NPID-----PID-----NPR-----PR-----NPS-----PS-----7-----8
      11      12      9      2      4      2
$ Card 2
$----WFL-----FORM-----INT-----NISR-----NISS-----IMASS-----7-----8
      1      0      1      2      2      0
$ Cards A
$rk-----1-----2-----3-----4-----5-----6-----7-----8
      0.0      0.0      0.0      1.0      2.0      3.0      4.0      5.0
      6.0      7.0      7.0      7.0
$ Cards B
$sk-----1-----2-----3-----4-----5-----6-----7-----8
      0.0      0.0      0.0      1.0      2.0      2.0      2.0
$ Cards C
$net-----N1-----N2-----N3-----N4-----N5-----N6-----N7-----N8
      1      2      3      4      5      6      7      8
      9      11      12      13      14      15      16      17      18
      19      21      22      23      24      25      26      27      28
      29      31      32      33      34      35      36      37      38
      39
$ Cards D (optional if WFL.ne.0)
$wt-----W1-----W2-----W3-----W4-----W5-----W6-----W7-----W8
      1.0      0.9      0.8      0.7      0.8      0.9      0.7      0.8
      1.0      0.8      0.7      0.6      0.5      0.6      0.7      0.6      0.7
      0.8      0.7      0.6      0.5      0.4      0.5      0.6      0.5      0.6
      0.7      0.6      0.5      0.4      0.5      0.6      0.5      0.6
      1.0      0.9      0.8      0.7      0.8      0.9      0.7      0.8
      1.0
  
```



**Figure 16.17.** Example of a bi-quadratic \*ELEMENT\_SHELL\_NURBS\_PATCH keyword definition

# \*ELEMENT

# \*ELEMENT\_SHELL\_SOURCE\_SINK

## \*ELEMENT\_SHELL\_SOURCE\_SINK

Purpose: Define a strip of shell elements of a single part ID to simulate a continuous forming operation. This option requires logical regular meshing of rectangular elements, which implies that the number of nodal points across the strip is constant along the length. Elements are created at the source and disappear at the sink. The advantage of this approach is that it is not necessary to define an enormous number of elements to simulate a continuous forming operation. Currently, only one source-sink definition is allowed. The boundary conditions at the source are discrete nodal point forces to keep the work piece in tension. At the sink, displacement boundary conditions are applied.

Card            1            2            3            4            5            6            7            8

Variable	NSSR	NSSK	PID					
Type	I	I	I					
Default	none	none	none					

### VARIABLE

### DESCRIPTION

NSSR	Node set at source. Provide an ordered set of nodes between corner nodes, which include the corner nodes.
NSSK	Node set at sink. Provide an ordered set of nodes between corner nodes, which include the corner nodes.
PID	Part ID of work piece.

**\*ELEMENT\_SOLID\_{OPTION}**

Available options include:

**<BLANK>**

**ORTHO**

**DOF**

**TET4TOTET10**

Purpose: Define three-dimensional solid elements including 4 noded tetrahedrons and 8-noded hexahedrons. The type of solid element and its formulation is specified through the part ID (see \*PART) and the section ID (see \*SECTION\_SOLID\_OPTION). Also, a local coordinate system for orthotropic and anisotropic materials can be defined by using the ORTHO option. If extra degrees of freedom are needed, the DOF option should be used. The option TET4TOTET10 converts 4 node tetrahedrons to 10 node tetrahedrons. See remarks below.

Card 1            1            2            3            4            5            6            7            8            9            10

Variable	EID	PID								
Type	I	I								
Default	None	none								
Remarks	2									

Card 2            1            2            3            4            5            6            7            8            9            10

Variable	N1	N2	N3	N4	N5	N6	N7	N8	N9	N10
Type	I	I	I	I	I	I	I	I	I	I
Default	None	none	none	none	none	None	none	none	none	none

**Optional Cards (Required if ORTHO is specified after the keyword)**

Optional card 1    1        2        3        4        5        6        7        8        9        10

Variable	A1 or BETA	A2	A3		
Type	F	F	F		
Default	0.	0.	0.		
Remarks	3				

Optional card 2    1        2        3        4        5        6        7        8        9        10

Variable	D1	D2	D3		
Type	F	F	F		
Default	0.	0.	0.		
Remarks	3				

**Optional Card (Required if DOF is specified after the keyword)**

Card                1        2        3        4        5        6        7        8        9        10

Variable			NS1	NS2	NS3	NS4	NS5	NS6	NS7	NS8
Type			I	I	I	I	I	I	I	I
Default			none	none	none	None	none	none	none	none
Remarks										



---

<b>VARIABLE</b>	<b>DESCRIPTION</b>
EID	Element ID. A unique number has to be chosen.
PID	Part ID, see *PART.
N1	Nodal point 1
N2	Nodal point 2
N3	Nodal point 3
.	.
.	.
N10	Nodal point 10
A1 or BETA	x-component of local material direction a, or else rotation angle BETA in degrees (see remark 5).
A2	y-component of local material direction a.
A3	z-component of local material direction a.
D1	x-component of vector in the plane of the material vectors a and b.
D2	y-component of vector in the plane of the material vectors a and b.
D3	z-component of vector in the plane of the material vectors a and b.
NS1	Scalar node 1
NS2	Scalar node 2
NS3	Scalar node 3
NS4	Scalar node 4
NS5	Scalar node 5
NS6	Scalar node 6
NS7	Scalar node 7
NS8	Scalar node 8

**Remarks:**

1. The option TET4TOTET10 automatically converts 4 node tetrahedron solids to 10 node quadratic tetrahedron solids. Additional mid-side nodes are created which are shared by all tetrahedron elements that contain the edge. The user node ID's for these generated nodes are offset after the largest user node ID defined in the input file. When defining the \*SECTION\_SOLID keyword, the element type must be specified as either 16 or 17 which are the 10-noded tetrahedrons in LS-DYNA.
2. Four, six, and eight node elements are depicted in Figure 16.18 where the ordering of the nodal points is shown. This ordering must be followed or code termination will occur during the initialization phase with a negative volume message. The input of nodes on the element cards for the tetrahedron and pentahedron elements is given by:

4-noded tetrahedron N1, N2, N3, N4, N4, N4, N4, 0, 0

6-noded pentahedron N1, N2, N3, N4, N5, N5, N6, N6, 0, 0

If hexahedrons are mixed with tetrahedrons and pentahedrons in the input under the same part ID, degenerate tetrahedrons and pentahedrons are used. One problem with degenerate elements is related to an uneven mass distribution (node 4 of the tetrahedron has five times the mass of nodes 1-3) which can make these elements somewhat unstable with the default time step size. By using the control flag under the keyword, \*CONTROL\_SOLID, automatic sorting can be invoked to treat the degenerate elements as type 10 and type 15 tetrahedron and pentahedron elements, respectively.

For elements with 4-8 nodes the card formats of LS-DYNA versions 940-970 are still valid. Card 2 is not defined in the older format.

**Card Format**

Card 1            1            2            3            4            5            6            7            8            9            10

Variable	EID	PID	N1	N2	N3	N4	N5	N6	N7	N8
Type	I	I	I	I	I	I	I	I	I	I

3. For the orthotropic and anisotropic material models the local directions may be defined on the second card following the element connectivity definition. The local directions are then computed from the two vectors such that (see Figure 16.19):

$$\mathbf{c} = \mathbf{a} \times \mathbf{d} \text{ and } \mathbf{b} = \mathbf{c} \times \mathbf{a} .$$

These vectors are internally normalized within LS-DYNA. If the material model uses AOPT=3, the a and b axes will be rotated about the c axis by the BETA angle on the material card.

- 4. Stress output for solid elements is in the global coordinate system by default.
- 5. If vector **d** is input as a zero length vector, then A1 is interpreted as an offset rotation angle in degrees which describes a rotation about the **c**-axis of the **a-b-c** coordinate system that is defined by AOPT and associated parameters on the \*MAT input. This angle overrides the offset angle defined by BETA on the \*MAT input.
- 6. The scalar nodes specified on the optional card refer to the scalar nodes defined by the user to hold additional degrees of freedom for solids with this capability. This option is primarily to be used with user defined solids.

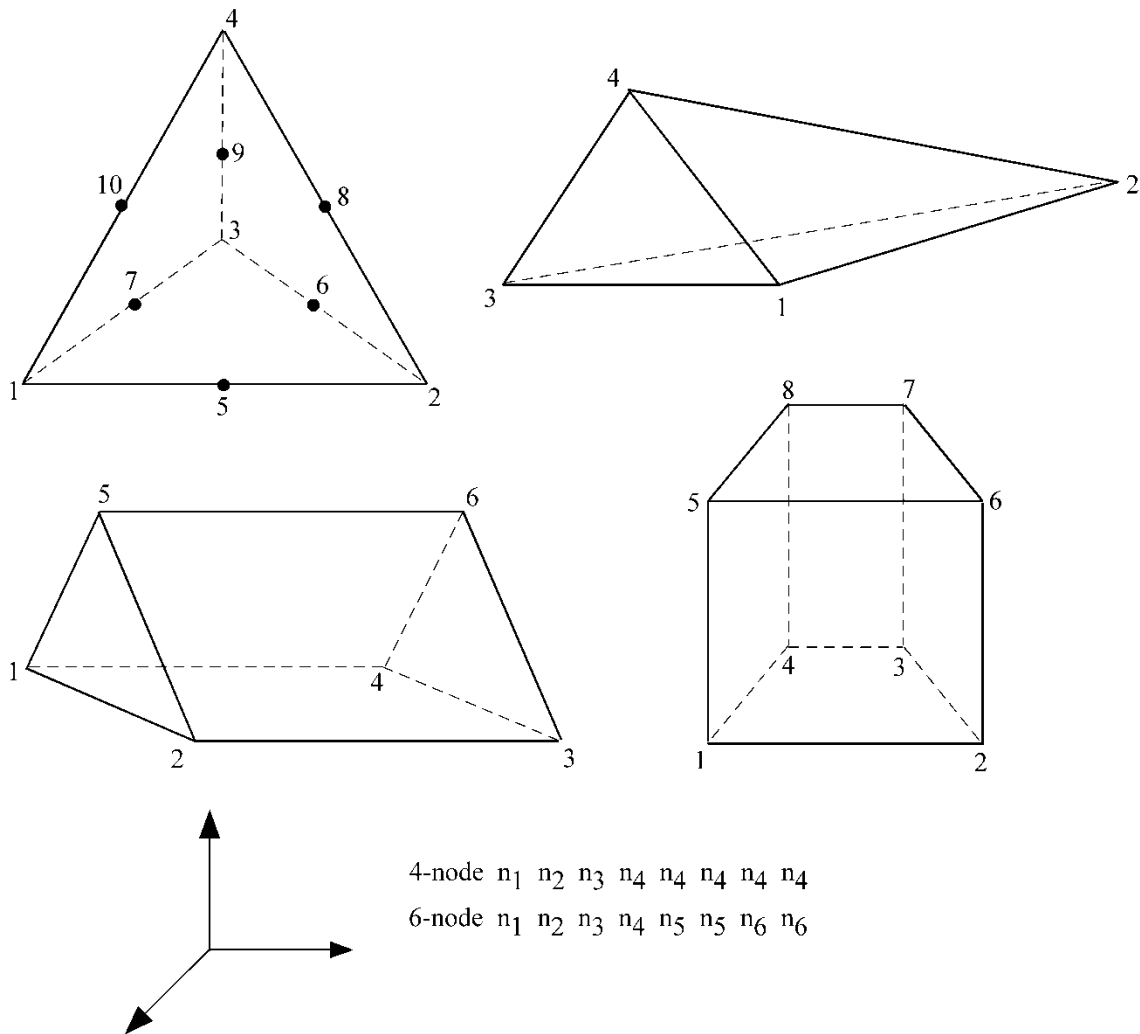
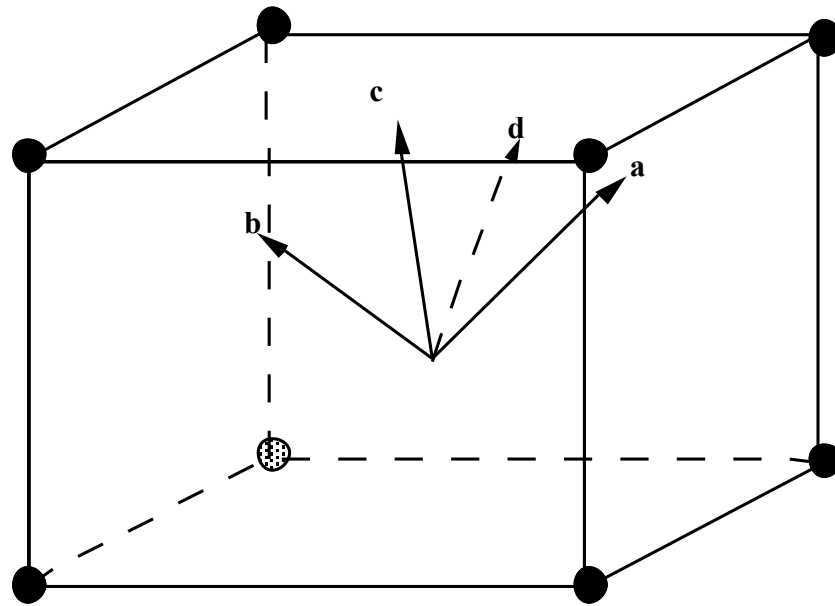


Figure 16.18. Four, six, and eight node solid elements. Nodes 1-4 are on the bottom surface.



**Figure 16.19.** Two vectors **a** and **d** are defined and the triad is computed and stored.

**\*ELEMENT\_SPH**

Purpose: Define a lumped mass element assigned to a nodal point.

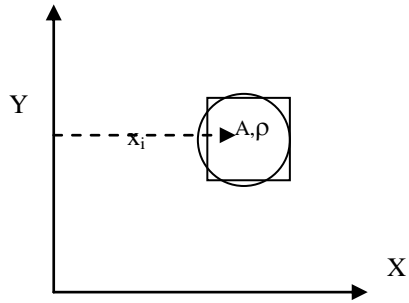
Card            1            2            3            4            5            6            7            8            9            10

Variable	NID	PID	MASS							
Type	I	I	F							
Default	none	none	0.							
Remarks			1							

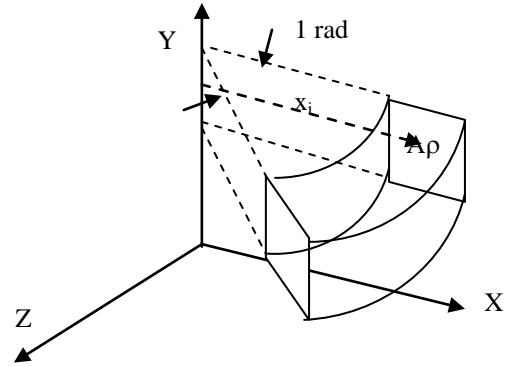
<u>VARIABLE</u>	<u>DESCRIPTION</u>
NID	Node ID and Element ID are the same for the SPH option.
PID	Part ID to which this node (element) belongs.
MASS	Mass value

**Remarks:**

1. Axisymmetric SPH, IDIM= -2 in CONTROL\_SPH, is defined on global X-Y plane, with Y-axis as the axis of rotation. An axisymmetric SPH element has a mass of  $A\rho$ , where  $\rho$  is its density, A is the area of the SPH element and can be approximated by the area of its corresponding axisymmetric shell element, see Figure 16.20. The mass printout in d3hsp is the mass per radian, i.e.,  $A\rho x_i$ , see Figure 16.20.



An axisymmetric SPH and corresponding shell



Mass printout in d3hsp, mass/radian

**Figure 16.20.**

**\*ELEMENT\_TRIM**

Purpose: Define a part subset to be trimmed by \*DEFINE\_CURVE\_TRIM.

Card 1            1            2            3            4            5            6            7            8

Variable	PSID								
Type	I								
Default	none								

**VARIABLE**

**DESCRIPTION**

PSID

Part set ID for trimming, see \*SET\_PART.

**Remarks:**

1. This keyword is used in combination with \*DEFINE\_CURVE\_TRIM to trim the parts in PSID at time=0, i.e. before the simulation begins.

**\*ELEMENT\_TSHELL**

Available options include:

<BLANK>

**COMPOSITE**

Purpose: Define an eight node thick shell element which is available with either fully reduced or selectively reduced integration rules. Thick shell formulation types 1,2, and 3 are plane stress elements can be used as an alternative to the 4 node shell elements in cases where an 8-noded element is desired. Thick shell formulation type 5 is based on an enhanced strain formulation and uses full three dimensional constitutive laws. See \*SECTION\_TSHELL. Care must be taken in defining the element connectivity as N1 to N4 define the lower surface of the thick shell. The number of through-thickness integration points is defined by the user. The definition is completed by the \*PART and \*SECTION\_TSHELL cards. The COMPOSITE option allows an arbitrary number of integration points across the thick shell thickness of thick shells sharing the same part ID.

Card 1                    1            2            3            4            5            6            7            8            9            10

Variable	EID	PID	N1	N2	N3	N4	N5	N6	N7	N8
Type	I	I	I	I	I	I	I	I	I	I
Default	none	none	none	none	none	none	none	none	none	none
Remarks			1							



Optional Card (Required if COMPOSITE is specified)

The material ID, thickness, and material angle for each through-thickness integration point of a composite shell are provided below (up to two integration points per card). The integration point data should be given sequentially starting with the bottommost integration point. The total number of integration points is determined by the number of entries on these cards. The total thickness is defined by the location of nodes on the top and bottom surface, so the THICKi values are scaled to fit the element. Define as many cards as needed.

Card 2            1            2            3            4            5            6            7            8

Variable	MID1	THICK1	B1		MID2	THICK2	B2	
Type	I	F	F		I	F	F	

Card 2            1            2            3            4            5            6            7            8

Variable	MID3	THICK3	B3		Etc.			
Type	I	F	F		I	F	F	

<u>VARIABLE</u>	<u>DESCRIPTION</u>
EID	Element ID. Unique numbers have to be used.
PID	Part ID, see *PART.
N1	Nodal point 1
N2	Nodal point 2
N3	Nodal point 3
.	.
N8	Nodal point 8
MIDi	Material ID of integration point i, see *MAT_
THICKi	Thickness of integration point i

<u>VARIABLE</u>	<u>DESCRIPTION</u>
Bi	Material angle of integration point i

**Remarks:**

1. The correct numbering of the nodes is essential for correct use. Nodes  $n_1$  to  $n_4$  define the lower surface, and nodes  $n_5$  to  $n_8$  define the upper surface. If one point integration is used (see \*SECTION\_TSHELL), the integration points then lie along the t-axis as depicted in Figure 16.21. Two by two selective reduced integration is also available. Extreme care must be used in defining the connectivity to insure proper orientation.
2. The stresses for this shell element are output in the global coordinate system.
3. To define a thick shell wedge element nodal pairs  $n_3$  &  $n_4$  and  $n_7$  &  $n_8$  are repeated. The ordering is then  $n_1, n_2, n_3, n_3, n_4, n_5, n_6, n_6$ , where nodes  $n_1, n_2, n_3$  form the lower triangular face and nodes  $n_4, n_5, n_6$  for the upper triangular face of the wedge.

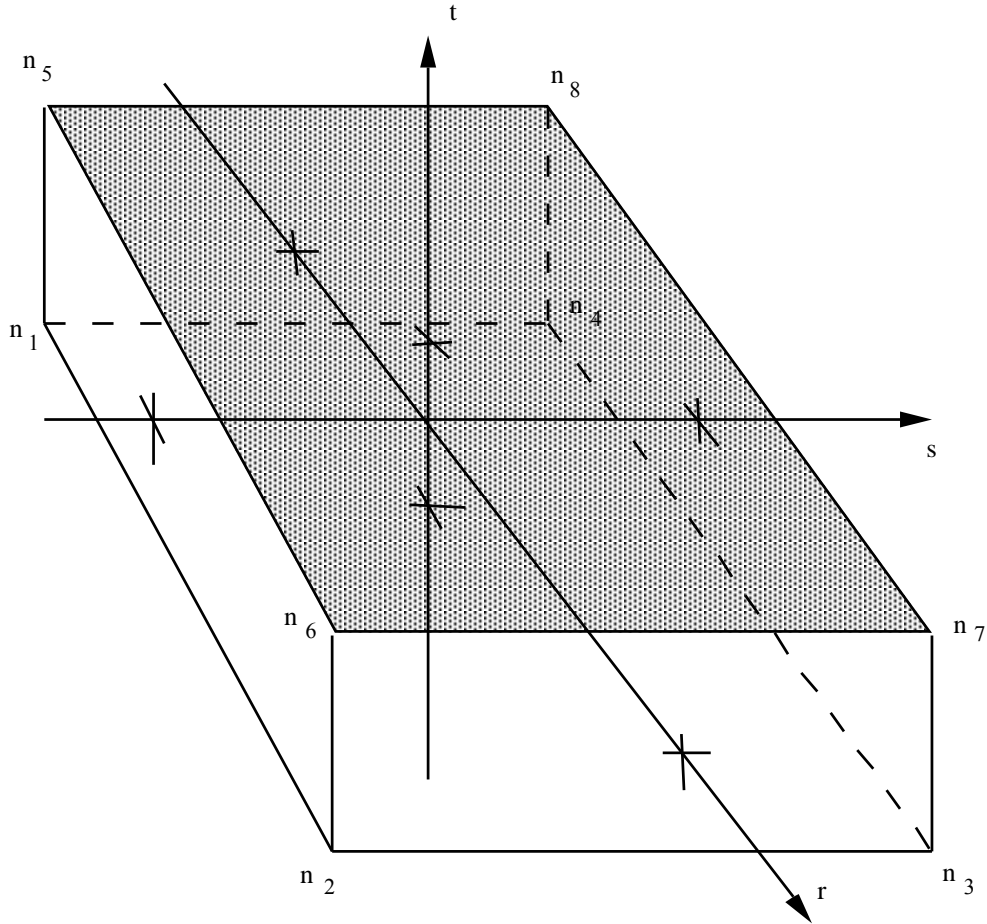


Figure 16.21. Solid 8-node Shell Element.



# **\*EOS**

LS-DYNA has historically referenced equations of state by type identifiers. Below these identifiers are given with the corresponding keyword name in the order that they appear in the manual. The equations of state can be used with a subset of the materials that are available for solid elements. Type 15 is linked to the type 2 thick shell element and can be used to model engine gaskets.

<b>TYPE 1:</b>	<b>*EOS_LINEAR_POLYNOMIAL</b>
<b>TYPE 2:</b>	<b>*EOS_JWL</b>
<b>TYPE 3:</b>	<b>*EOS_SACK_TUESDAY</b>
<b>TYPE 4:</b>	<b>*EOS_GRUNEISEN</b>
<b>TYPE 5:</b>	<b>*EOS_RATIO_OF_POLYNOMIALS</b>
<b>TYPE 6:</b>	<b>*EOS_LINEAR_POLYNOMIAL_WITH_ENERGY_LEAK</b>
<b>TYPE 7:</b>	<b>*EOS_IGNITION_AND_GROWTH_OF_REACTION_IN_HE</b>
<b>TYPE 8:</b>	<b>*EOS_TABULATED_COMPACTION</b>
<b>TYPE 9:</b>	<b>*EOS_TABULATED</b>
<b>TYPE 10:</b>	<b>*EOS_PROPELLANT_DEFLAGRATION</b>
<b>TYPE 11:</b>	<b>*EOS_TENSOR_PORE_COLLAPSE</b>
<b>TYPE 12:</b>	<b>*EOS_IDEAL_GAS</b>
<b>TYPE 14:</b>	<b>*EOS_JWLB</b>
<b>TYPE 15:</b>	<b>*EOS_GASKET</b>
<b>TYPE 16:</b>	<b>*EOS_MIE_GRUNEISEN</b>
<b>TYPE 21-30:</b>	<b>*EOS_USER_DEFINED</b>

An additional option **\_TITLE** may be appended to all the **\*EOS** keywords. If this option is used then an additional line is read for each section in 80a format which can be used to describe the equation of state. At present LS-DYNA does not make use of the title. Inclusion of title simply gives greater clarity to input decks.

# \*EOS

---

## DEFINITIONS & NOTES ON SOME COMMONLY USED PARAMETERS:

In order to prescribe the boundary and/or initial thermodynamic condition, manual computations are often necessary. Conventions or definitions must be established to simplify this process. Some basic variables are defined in the following. Since many of these variables have already been denoted by different symbols, the notations used here are unique in this section only! They are presented to only clarify their usage. A corresponding SI unit set is also presented as an example.

First consider a few volumetric parameters since they are a measure of compression (or expansion).

$$\text{Volume} = V \approx (\text{m}^3)$$

$$\text{Mass} = M \approx (\text{Kg})$$

$$\text{Current specific volume (per mass)} = v = \frac{V}{M} = \frac{1}{\rho} \approx \left( \frac{\text{m}^3}{\text{Kg}} \right)$$

$$\text{Reference specific volume} = v_0 = \frac{V_0}{M} = \frac{1}{\rho_0} \approx \left( \frac{\text{m}^3}{\text{Kg}} \right)$$

$$\text{Relative volume} = v_r = \frac{V}{V_0} = \frac{(V/M)}{(V_0/M)} = \frac{v}{v_0} = \frac{\rho_0}{\rho}$$

$$\text{Current normalized volume increment} = \frac{dv}{v} = \frac{v - v_0}{v} = 1 - \frac{1}{v_r} = 1 - \frac{\rho}{\rho_0}$$

$$\text{A frequently used volumetric parameter is } \mu = \frac{1}{v_r} - 1 = \frac{v_0 - v}{v} = -\frac{dv}{v} = \frac{\rho}{\rho_0} - 1$$

$$\text{Sometimes another volumetric parameter is used: } \eta = \frac{v_0}{v} = \frac{\rho}{\rho_0}$$

$$\text{Thus the relation between } \mu \text{ and } \eta \text{ is } \mu = \frac{v_0 - v}{v} = \eta - 1$$

The following table summarizes these volumetric parameters.

VARIABLES	COMPRESSION	NO LOAD	EXPANSION
$\nu_r = \frac{v}{v_0} = \frac{\rho_0}{\rho}$	< 1	1	> 1
$\eta = \frac{1}{\nu_r} = \frac{v_0}{v} = \frac{\rho}{\rho_0}$	> 1	1	< 1
$\mu = \frac{1}{\nu_r} - 1 = \eta - 1$	> 0	0	< 0

**V0 – INITIAL REALTIVE VOLUME**

There are 3 definitions of density that must be distinguished from each other:

$\rho_0 = \rho_{ref}$  = Density at nominal/reference state, usually non-stress or non-deformed state.

$\rho|_{t=0}$  = Density at t = 0

$\rho$  = Current density

Recalling the current relative volume,  $\nu_r = \frac{\rho_0}{\rho} = \frac{v}{v_0}$ , and the relative volume at time=0 is then

$\nu_{r0} = \nu_r|_{t=0} = \frac{\rho_0}{\rho|_{t=0}} = \frac{v|_{t=0}}{v_0}$ . Generally, the V0 input parameter in an \*EOS\_ card, refers to this

$\nu_{r0}$ .  $\rho_0$  is generally the density defined in the \*MAT\_ card. Hence, if a material is mechanically compressed at t=0, V0, or  $\nu_{r0}$ , the initial relative volume, may be computed and input accordingly ( $v_0 \neq V0$ ).

The “reference” state is a unique state with respect to which the material stress tensor is computed. Therefore  $v_0$  is very critical in computing the pressure level in a material. Incorrect choice of  $v_0$  would lead to incorrect pressure computed. In general,  $v_0$  is chosen such that at zero compression or expansion, the material should be in equilibrium with its ambient surrounding. In many of the equations shown in the EOS section,  $\mu$  is frequently used as a measure of compression (or expansion). However, the users must clearly distinguish between  $\mu$  and  $\nu_{r0}$ .

# \*EOS

---

## E0 - INTERNAL ENERGY

Internal energy represents the thermal energy state (temperature dependent component) of a system. One definition for internal energy is

$$E = MC_v T \approx (\text{Joule})$$

Note that the capital “E” here is the absolute internal energy. It is not the same as that used in the subsequent \*EOS keyword input, or some equations shown for each \*EOS\_ card. This internal energy is often defined with respect to a mass or volume unit.

Internal energy per unit mass (also called specific internal energy):

$$e = \frac{E}{M} = C_v T \approx \left( \frac{\text{Joule}}{\text{Kg}} \right)$$

Internal energy per unit current volume:

$$e_v = \frac{M}{V} C_v T = \rho C_v T = \frac{C_v T}{\nu} \approx \left( \frac{\text{Joule}}{\text{m}^3} = \frac{\text{N}}{\text{m}^2} \right)$$

Internal energy per unit reference volume:

$$e_{v_0} = \frac{M}{V_0} C_v T = \rho_0 C_v T = \frac{C_v T}{\nu_0} \approx \left( \frac{\text{Joule}}{\text{m}^3} = \frac{\text{N}}{\text{m}^2} \right).$$

$e_{v_0}$  typically refers to the capital “E” shown in some equations under this “EOS” section. Hence the initial “internal energy per unit reference volume”, E0, a keyword input parameter in the \*EOS section can be computed from

$$e_{v_0} \Big|_{t=0} = \rho_0 C_v T \Big|_{t=0}$$

To convert from  $e_{v_0}$  to  $e_v$ , simply divide  $e_{v_0}$  by  $\nu_r$

$$e_v = \rho C_v T = [\rho_0 C_v T] \frac{\rho}{\rho_0} = \frac{e_{v_0}}{\nu_r}$$

## EQUATION OF STATE (EOS)

A thermodynamic state of a homogeneous material, not undergoing any chemical reactions or phase changes, may be defined by two state variables. This relation is generally called an equation of state. For example, a few possible forms relating pressure to two other state variables are



$$P = P(\rho, T) = P(\nu, e) = P(\nu_r, e_v) = P(\mu, e_{v_0})$$

The last equation form is frequently used to compute pressure. The EOS for solid phase materials is sometimes partitioned into 2 terms, a cold pressure and a thermal pressure

$$P = P_c(\mu) + P_T(\mu, e_{v_0})$$

$P_c(\mu)$  is the cold pressure hypothetically evaluated along a 0-degree-Kelvin isotherm. This is sometimes called a 0-K pressure-volume relation or cold compression curve.  $P_T(\mu, e_{v_0})$  is the thermal pressure component that depends on both volumetric compression and thermal state of the material.

Different forms of the EOS describe different types of materials and how their volumetric compression (or expansion) behaviors. The coefficients for each EOS model come from data-fitting, phenomenological descriptions, or derivations based on classical thermodynamics, etc.

## LINEAR COMPRESSION

In low pressure processes, pressure is not significantly affected by temperature. When volumetric compression is within an elastic linear deformation range, a linear bulk modulus may be used to relate volume changes to pressure changes. Recalling the definition of an isotropic bulk modulus is [Fung 1965]  $\frac{\Delta \nu}{\nu} = -\frac{P}{K}$ . This may be rewritten as  $P = K \left[ -\frac{\Delta \nu}{\nu} \right] = K \mu$ . The bulk modulus,  $K$ , thus is equivalent to  $C_1$  in `*EOS_LINEAR_POLYNOMIAL` when all other coefficients are zero. This is a simplest form of an EOS. To initialize a pressure for such a material, only  $\nu_{r_0}$  must be defined.

## INITIAL CONDITION SETTING

In general, a thermodynamic state must be defined by two state variables. The need to specify  $\nu_{r_0}$  and/or  $e_{v_0}|_{t=0}$  depends on the form of the EOS chosen. The user should review the equation term-by-term to establish what parameters to be initialized.

For many of the EOS available, pressure is specified (given), and the user must make an assumption on either  $e_{v_0}|_{t=0}$  or  $\nu_{r_0}$ . Consider two possibilities (a)  $T|_{t=0}$  is defined or assumed from which  $e_{v_0}|_{t=0}$  may be computed, or (2)  $\rho|_{t=0}$  is defined or assumed from which  $\nu_{r_0}$  may be obtained.

## WHEN TO USE THE EOS

For small strains considerations, a total stress tensor may be partitioned into a deviatoric stress component and a mechanical pressure.

## \*EOS

---

$$\sigma_{ij} = \sigma'_{ij} + \frac{\sigma_{kk}}{3} \delta_{ij} = \sigma'_{ij} - P \delta_{ij}$$
$$P = -\frac{\sigma_{kk}}{3} \Leftrightarrow \frac{\sigma_{kk}}{3} = -P$$

The pressure component may be written from the diagonal stress components.

Note that  $\frac{\sigma_{kk}}{3} = \frac{[\sigma_{11} + \sigma_{22} + \sigma_{33}]}{3}$  is positive in tension while P is positive in compression.

Similarly the total strain tensor may be partitioned into a deviatoric strain component (volume-preserving deformation) and a volumetric deformation.

$$\varepsilon_{ij} = \varepsilon'_{ij} + \frac{\varepsilon_{kk}}{3} \delta_{ij}$$

where  $\frac{\varepsilon_{kk}}{3}$  is called the mean normal strain, and  $\varepsilon_{kk}$  is called the dilatation or volume strain (change in volume per unit initial volume)

$$\varepsilon_{kk} = \frac{V - V_0}{V_0}$$

Roughly speaking, a typical convention may refer to the relation  $\sigma'_{ij} = f(\varepsilon'_{ij})$  as a “constitutive equation”, and  $P = f(\mu, e_{v_0})$  as an EOS. The use of an EOS may be omitted only when volumetric deformation is very small, and  $|P| \ll |\sigma'_{ij}|$ .

\*EOS\_LINEAR\_POLYNOMIAL

Purpose: Define coefficients for linear polynomial EOS and initialize the initial thermodynamic state of the material. This is done by defining E0 and V0 below.

Card 1            1            2            3            4            5            6            7            8

Variable	EOSID	C0	C1	C2	C3	C 4	C5	C6
Type	A8	F	F	F	F	F	F	F

Card 2            1            2            3            4            5            6            7            8

Variable	E0	V0						
Type	F	F						

<u>VARIABLE</u>	<u>DESCRIPTION</u>
EOSID	Equation of state ID, a unique number or label not exceeding 8 characters must be specified.
C0	The 0 <sup>th</sup> polynomial equation coefficient.
C1	The 1 <sup>st</sup> polynomial equation coefficient (when used by itself, this is the <b>elastic</b> bulk modulus, i.e. it cannot be used for deformation that is beyond the elastic regime).
...	...
C6	The 6 <sup>th</sup> polynomial equation coefficient.
E0	Initial internal energy per unit reference volume (see the beginning of the *EOS section).
V0	Initial relative volume (see the beginning of the *EOS section).

**Remarks:**

1. The linear polynomial equation of state is linear in internal energy. The pressure is given by:

$$P = C_0 + C_1\mu + C_2\mu^2 + C_3\mu^3 + (C_4 + C_5\mu + C_6\mu^2)E.$$

where terms  $C_2\mu^2$  and  $C_6\mu^2$  are set to zero if  $\mu < 0$ ,  $\mu = \frac{\rho}{\rho_0} - 1$ , and  $\frac{\rho}{\rho_0}$  is the ratio of current density to reference density.  $\rho_0$  is a nominal or reference density defined in the \*MAT\_NULL card.

The linear polynomial equation of state may be used to model gas with the gamma law equation of state. This may be achieved by setting:

$$C_0 = C_1 = C_2 = C_3 = C_6 = 0$$

and

$$C_4 = C_5 = \gamma - 1$$

where

$$\gamma = \frac{C_p}{C_v}$$

is the ratio of specific heats. Pressure for a perfect gas is then given by:

$$P = (\gamma - 1) \left\{ \begin{array}{c} \rho \\ \rho_0 \end{array} \right\} E = (\gamma - 1) \left\{ \begin{array}{c} e_{v0} \\ \nu_r \end{array} \right\}$$

E has the unit of pressure (where  $E = e_{v0}$  and  $\nu_r = \rho_0/\rho$ )

2. When  $C_0 \neq 0$ , it does not necessarily mean that the initial pressure is zero,  $P_0 \neq C_0$ ! The initial pressure depends the values of all the coefficients and on  $\mu|_{t=0}$  and  $E|_{t=0}$ . The pressure in a material is computed from the whole equation above,  $P = P(\mu, E)$ . It is always preferable to initialize the initial condition based on  $\mu|_{t=0}$  and  $E|_{t=0}$ . The use of  $C_0 \neq 0$  must be done with caution as it may change the form and behavior of the material. The safest way is to use the whole EOS equation to manually check for the pressure value. For example, for ideal gas, it is wrong to define  $C_4 = C_5 = \gamma - 1$  and  $C_0 \neq 0$  at the same time.
3. V0 and E0 defined in this card must be the same as the time-zero ordinates for the 2 load curves defined in the \*BOUNDARY\_AMBIENT\_EOS card, if it is used. This is so that they would both consistently define the same initial state for a material.

\*EOS\_JWL

This is Equation of state Form 2.

Card	1	2	3	4	5	6	7	8
Variable	EOSID	A	B	R1	R2	OMEG	E0	VO
Type	A8	F	F	F	F	F	F	F

<u>VARIABLE</u>	<u>DESCRIPTION</u>
EOSID	Equation of state ID, a unique number or label not exceeding 8 characters must be specified.
A	
B	
R1	
R2	
OMEG	
VO	Initial relative volume.

**Remarks:**

The JWL equation of state defines the pressure as

$$p = A \left( 1 - \frac{\omega}{R_1 V} \right) e^{-R_1 V} + B \left( 1 - \frac{\omega}{R_2 V} \right) e^{-R_2 V} + \frac{\omega E}{V},$$

and is usually used for detonation products of high explosives.

**\*EOS\_SACK\_TUESDAY**

This is Equation of state Form 3.

Card	1	2	3	4	5	6	7	8
Variable	EOSID	A1	A2	A3	B1	B2	E0	V0
Type	A8	F	F	F	F	F	F	F

<u>VARIABLE</u>	<u>DESCRIPTION</u>
EOSID	Equation of state ID, a unique number or label not exceeding 8 characters must be specified.
A1	
A2	
A3	
B1	
B2	
E0	Initial internal energy
V0	Initial relative volume

**Remarks:**

The Sack equation of state defines pressure as

$$p = \frac{A_3}{V^{A_1}} e^{-A_2 V} \left( 1 - \frac{B_1}{V} \right) + \frac{B_2}{V} E$$

and is used for detonation products of high explosives.

\*EOS\_GRUNEISEN

This is Equation of state Form 4.

Card	1	2	3	4	5	6	7	8
Variable	EOSID	C	S1	S2	S3	GAMAO	A	E0
Type	A8	F	F	F	F	F	F	F

Card 2	1	2	3	4	5	6	7	8
Variable	V0							
Type	F							

<u>VARIABLE</u>	<u>DESCRIPTION</u>
EOSID	Equation of state ID, a unique number or label not exceeding 8 characters must be specified.
C	
S1	
S2	
S3	
GAMAO	
E0	Initial internal energy
V0	Initial relative volume

**Remarks:**

The Gruneisen equation of state with cubic shock velocity-particle velocity defines pressure for compressed materials as

$$p = \frac{\rho_0 C^2 \mu \left[ 1 + \left( 1 - \frac{\gamma_0}{2} \right) \mu - \frac{a}{2} \mu^2 \right]}{\left[ 1 - (S_1 - 1) \mu - S_2 \frac{\mu^2}{\mu+1} - S_3 \frac{\mu^3}{(\mu+1)^2} \right]^2} + (\gamma_0 + a \mu) E.$$

and for expanded materials as

$$p = \rho_0 C^2 \mu + (\gamma_0 + a \mu) E.$$

where C is the intercept of the  $v_s$ - $v_p$  curve;  $S_1$ ,  $S_2$ , and  $S_3$  are the coefficients of the slope of the  $v_s$ - $v_p$  curve;  $\gamma_0$  is the Gruneisen gamma; a is the first order volume correction to  $\gamma_0$ ; and

$$\mu = \frac{\rho}{\rho_0} - 1.$$



\*EOS\_RATIO\_OF\_POLYNOMIALS

This is Equation of state Form 5.

Card 1                    1                    2                    3                    4

Variable	EOSID			
Type	A8			

Card 2                    1                    2                    3                    4

Variable	A10	A11	A12	A13
Type	F	F	F	F

Card 3                    1                    2                    3                    4

Variable	A20	A21	A22	A23
Type	F	F	F	F

Card 4                    1                    2                    3                    4

Variable	A30	A31	A32	A33
Type	F	F	F	F

**\*EOS****\*EOS\_RATIO\_OF\_POLYNOMIALS**

Card 5                    1                    2                    3                    4

Variable	A40	A41	A42	A43
Type	F	F	F	F

Card 6                    1                    2                    3                    4

Variable	A50	A51	A52	A53
Type	F	F	F	F

Card 7                    1                    2                    3                    4

Variable	A60	A61	A62	A63
Type	F	F	F	F

Card 8                    1                    2                    3                    4

Variable	A70	A71	A72	A73
Type	F	F	F	F

Card 9                    1                    2                    3                    4

Variable	A14	A24		
Type	F	F		

Card 10                    1                    2                    3                    4

Variable	ALPH	BETA	E0	V0
Type	F	F	F	F

**VARIABLE**

**DESCRIPTION**

EOSID                    Equation of state ID, a unique number or label not exceeding 8 characters must be specified.

A10

A11

A12

A13

A20

A21

A22

A23

A30

A31

A32

A33

A40

A41

A42

A43

A50

<u>VARIABLE</u>	<u>DESCRIPTION</u>
A51	
A52	
A53	
A60	
A61	
A62	
A63	
A70	
A71	
A72	
A73	
A14	
A24	
ALPHA	
BETA	
E0	Initial internal energy
V0	Initial relative volume

**Remarks:**

The ratio of polynomials equation of state defines the pressure as

$$p = \frac{F_1 + F_2 E + F_3 E^2 + F_4 E^3}{F_5 + F_6 E + F_7 E^2} (1 + \alpha \mu)$$

where

$$F_i = \sum_{j=0}^n A_{ij} \mu^j \quad n = 4 \text{ if } i < 3$$

$$\mu = \frac{\rho}{\rho_0} - 1 \quad n = 3 \text{ if } i \geq 3$$

In expanded elements  $F_1$  is replaced by  $F_1' = F_1 + \beta \mu^2$ . By setting coefficient  $A_{10} = 1.0$ , the delta-phase pressure modeling for this material will be initiated. The code will reset it to 0.0 after setting flags.

# \*EOS

## \*EOS\_LINEAR\_POLYNOMIAL\_WITH\_ENERGY\_LEAK

### \*EOS\_LINEAR\_POLYNOMIAL\_WITH\_ENERGY\_LEAK

Card 1            1            2            3            4            5            6            7            8

Variable	EOSID	C0	C1	C2	C3	C4	C5	C6
Type	A8	F	F	F	F	F	F	F

Card 2            1            2            3            4            5            6            7            8

Variable	E0	V0	LCID					
Type	F	F	I					

#### VARIABLE

#### DESCRIPTION

EOSID	Equation of state ID, a unique number or label not exceeding 8 characters must be specified.
C0	
C1	
C2	
C3	
C4	
C5	
C6	
E0	Initial internal energy
V0	Initial relative volume
LCID	Load curve ID defining the energy deposition rate

**Remarks:**

This polynomial equation of state, linear in the internal energy per initial volume,  $E$ , is given by

$$p = C_0 + C_1\mu + C_2\mu^2 + C_3\mu^3 + (C_4 + C_5\mu + C_6\mu^2)E$$

in which  $C_0$ ,  $C_1$ ,  $C_2$ ,  $C_3$ ,  $C_4$ ,  $C_5$ , and  $C_6$  are user defined constants and

$$\mu = \frac{1}{V} - 1.$$

where  $V$  is the relative volume. In expanded elements, we set the coefficients of  $\mu^2$  to zero, i.e.,

$$C_2 = C_6 = 0$$

Internal energy,  $E$ , is increased according to an energy deposition rate versus time curve whose ID is defined in the input.

**\*EOS****\*EOS\_IGNITION\_AND\_GROWTH\_OF\_REACTION\_IN\_HE****\*EOS\_IGNITION\_AND\_GROWTH\_OF\_REACTION\_IN\_HE**

Card 1            1            2            3            4            5            6            7            8

Variable	EOSID	A	B	XP1	XP2	FREER	G	R1
Type	A8	F	F	F	F	F	F	F

Card 2            1            2            3            4            5            6            7            8

Variable	R2	R3	R5	R6	FMXIG	FREQ	GROW1	EM
Type	F	F	F	F	F	F	F	F

Card 3            1            2            3            4            5            6            7            8

Variable	AR1	ES1	CVP	CVR	EETAL	CCRIT	ENQ	TMP0
Type	F	F	F	F	F	F	F	F

Card 4            1            2            3            4            5            6            7            8

Variable	GROW2	AR2	ES2	EN	FMXGR	FMNGR		
Type	F	F	F	F	F	F		

**VARIABLE****DESCRIPTION**

EOSID	Equation of state ID, a unique number or label not exceeding 8 characters must be specified.
A	Product JWL constant (see second equation in Remarks)
B	Product JWL constant (see second equation in Remarks)



---

<b>VARIABLE</b>	<b>DESCRIPTION</b>
XP1	Product JWL constant (see second equation in Remarks)
XP2	Product JWL constant (see second equation in Remarks)
FRER	Constant in ignition term of reaction equation
G	$\omega C_v$ of product
R1	Unreacted JWL constant (see first equation in Remarks)
R2	Unreacted JWL constant (see first equation in Remarks)
R3	$\omega C_v$ of unreacted explosive
R5	Unreacted JWL constant (see first equation in Remarks)
R6	Unreacted JWL constant (see first equation in Remarks)
FMXIG	Maximum F for ignition term
FREQ	Constant in ignition term of reaction equation
GROW1	Constant in growth term of reaction equation
EM	Constant in growth term of reaction equation
AR1	Constant in growth term of reaction equation
ES1	Constant in growth term of reaction equation
CVP	Heat capacity of reaction products
CVR	Heat capacity of unreacted HE
EETAL	Constant in ignition term of reaction equation
CCRIT	Constant in ignition term of reaction equation
ENQ	Heat of reaction
TMP0	Initial temperature (°K)
GROW2	Constant in completion term of reaction equation
AR2	Constant in completion term of reaction equation
ES2	Constant in completion term of reaction equation

<u>VARIABLE</u>	<u>DESCRIPTION</u>
EN	Constant in completion term of reaction equation
FMXGR	Maximum F for growth term
FMNGR	Maximum F for completion term

**Remarks:**

Equation of State Form 7 is used to calculate the shock initiation (or failure to initiate) and detonation wave propagation of solid high explosives. It should be used instead of the ideal HE burn options whenever there is a question whether the HE will react, there is a finite time required for a shock wave to build up to detonation, and/or there is a finite thickness of the chemical reaction zone in a detonation wave. At relatively low initial pressures (<2-3 GPa), this equation of state should be used with material type 10 for accurate calculations of the unreacted HE behavior. At higher initial pressures, material type 9 can be used. A JWL equation of state defines the pressure in the unreacted explosive as

$$P_e = r_1 e^{-r_5 V_e} + r_2 e^{-r_6 V_e} + r_3 \frac{T_e}{V_e} \quad (r_3 = \omega_e c_v r)$$

where  $V_e$  and  $T_e$  are the relative volume and temperature, respectively, of the unreacted explosive. Another JWL equation of state defines the pressure in the reaction products as

$$P_p = a e^{-x p 1 V_p} + b e^{-x p 2 V_p} + \frac{g T_p}{V_p} \quad (g = \omega_p c_v p)$$

where  $V_p$  and  $T_p$  are the relative volume and temperature, respectively, of the reaction products. As the chemical reaction converts unreacted explosive to reaction products, these JWL equations of state are used to calculate the mixture of unreacted explosive and reaction products defined by the fraction reacted  $F$  ( $F=0$  implies no reaction,  $F=1$  implies complete reaction). The temperatures and pressures are assumed to be equal ( $T_e = T_p$ ,  $p_e = p_p$ ) and the relative volumes are additive, i.e.,

$$V = (1 - F) V_e + V_p$$

The chemical reaction rate for conversion of unreacted explosive to reaction products consists of three physically realistic terms: an ignition term in which a small amount of explosive reacts soon after the shock wave compresses it; a slow growth of reaction as this initial reaction spreads; and a rapid completion of reaction at high pressure and temperature. The form of the reaction rate equation is

$$\frac{\partial F}{\partial t} = f_{req} (1 - F)^{f_{rer}} (V_e^{-1} - 1 - c_{crit})^{c_{etal}} \quad (\text{Ignition})$$

$$+ \text{grow1}(1 - F)^{\text{es1}} F^{\text{ar1}} p^{\text{em}} \quad (\text{Growth})$$

$$+ \text{grow2}(1 - F)^{\text{es2}} f^{\text{ar2}} p^{\text{en}} \quad (\text{Completion})$$

The ignition rate is set equal to zero when  $F \geq \text{fmxig}$ , the growth rate is set equal to zero when  $F \geq \text{fmxgr}$ , and the completion rate is set equal to zero when  $F \leq \text{fmngr}$ .

Details of the computational methods and many examples of one and two dimensional shock initiation and detonation wave calculation can be found in the references (Cochran and Chan [1979], Lee and Tarver [1980]). Unfortunately, sufficient experimental data has been obtained for only two solid explosives to develop very reliable shock initiation models: PBX-9504 (and the related HMX-based explosives LX-14, LX-10, LX-04, etc.) and LX-17 (the insensitive TATB-based explosive). Reactive flow models have been developed for other explosives (TNT, PETN, Composition B, propellants, etc.) but are based on very limited experimental data.

History variables 5 and 8 are temperature and burn fraction, respectively. See NEIPH in \*DATABASE\_EXTENT\_BINARY if these output variables are desired in the databases for post-processing.

# \*EOS

# \*EOS\_TABULATED\_COMPACTON

## \*EOS\_TABULATED\_COMPACTON

Card 1            1            2            3            4            5            6            7            8

Variable	EOSID	GAMA	E0	V0				
Type	A8	F	F	F				

**Repeat Cards 2 and 3 for  $C_i$ ,  $T_i$ , and  $K_i$ . A total of 9 cards must be defined.**

Card 2            1            2            3            4            5

Variable	EV1	EV2	EV3	EV4	EV5
Type	F	F	F	F	F

Card 3            1            2            3            4            5

Variable	EV6	EV7	EV8	EV9	EV10
Type	F	F	F	F	F

### VARIABLE

### DESCRIPTION

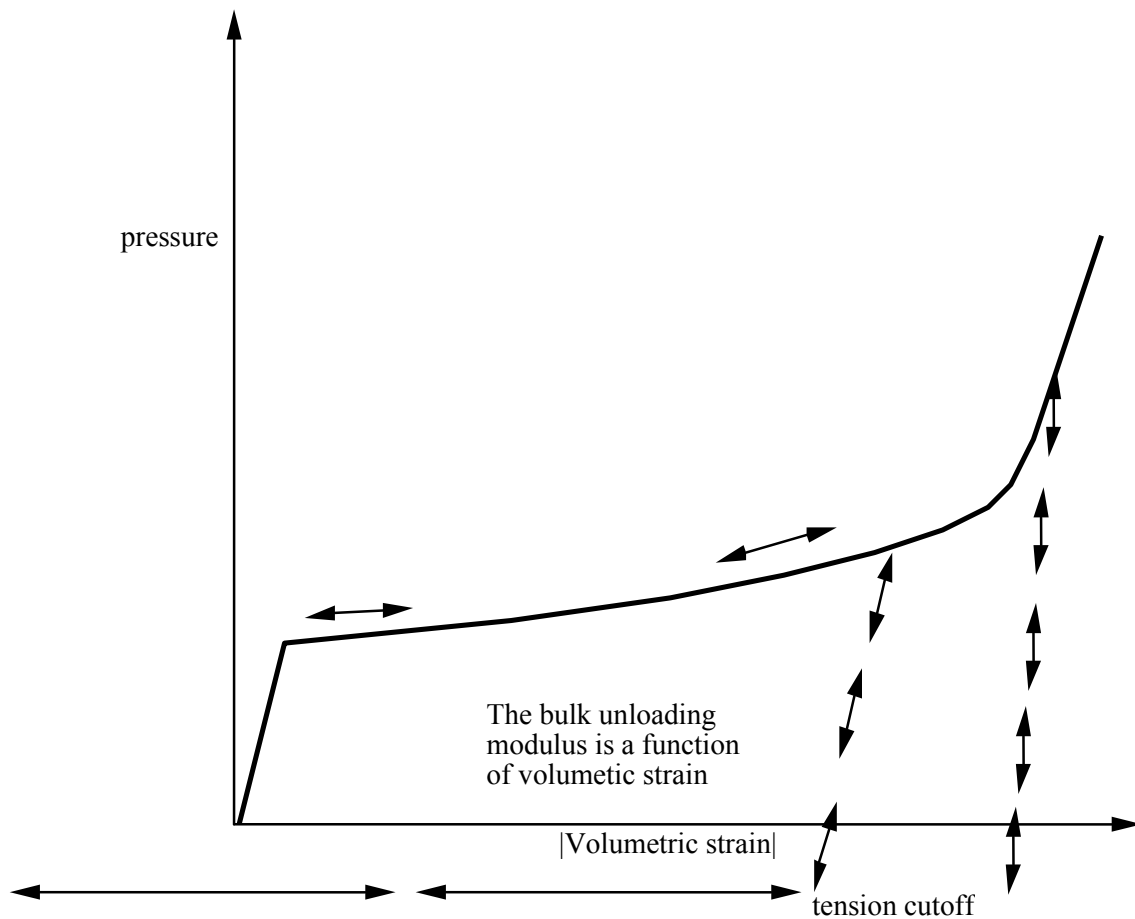
EOSID	Equation of state ID, a unique number or label not exceeding 8 characters must be specified.
$\epsilon V1, \epsilon V2, \dots \epsilon VN$	Volumetric strain, $\ln V$
$K1, K2, \dots KN$	Bulk unloading modulus
GAMA	$\gamma$
E0	Initial internal energy
V0	Initial relative volume

**Remarks:**

The tabulated compaction model is linear in internal energy. Pressure is defined by

$$p = C(\epsilon_v) + \gamma T(\epsilon_v)E$$

in the loading phase. The volumetric strain,  $\epsilon_v$  is given by the natural logarithm of the relative volume  $V$ . Unloading occurs along the unloading bulk modulus to the pressure cutoff. Reloading always follows the unloading path to the point where unloading began, and continues on the loading path, see Figure 17.1. Up to 10 points and as few as 2 may be used when defining the tabulated functions. LS-DYNA will extrapolate to find the pressure if necessary.



**Figure 17.1.** Pressure versus volumetric strain curve for Equation of state Form 8 with compaction. In the compacted states the bulk unloading modulus depends on the peak volumetric strain. Volumetric strain values should be input with correct sign (negative in compression) and in descending order. Pressure is positive in compression.

# \*EOS

# \*EOS\_TABULATED

## \*EOS\_TABULATED

This is Equation of state Form 9.

Card 1            1            2            3            4            5            6            7            8

Variable	EOSID	GAMA	E0	V0	LCC	LCT		
Type	A8	F	F	F	I	I		

**Define 6 additional cards if and only if LCC and LCT equal zero.  
Repeat Cards 2 and 3 to define  $C_i$  and  $T_i$ .**

Card 2            1            2            3            4            5

Variable	EV1	EV2	EV3	EV4	EV5
Type	F	F	F	F	F

Card 3            1            2            3            4            5

Variable	EV6	EV7	EV8	EV9	EV10
Type	F	F	F	F	F

### VARIABLE

### DESCRIPTION

EOSID	Equation of state ID, a unique number or label not exceeding 8 characters must be specified.
GAMA	$\gamma$
E0	Initial internal energy
V0	Initial relative volume

---

<u>VARIABLE</u>	<u>DESCRIPTION</u>
LCC	Load curve defining tabulated function C. See equation in Remarks. The abscissa values of LCC and LCT must increase monotonically. The definition can extend into the tensile regime.
LCT	Load curve defining tabulated function T. See equation in Remarks.
EV1,EV2, ...EVN	Volumetric strain, $\ln(V)$ , where V is the relative volume. The first abscissa point, EV1, must be 0.0 or positive if the curve extends into the tensile regime with subsequent points decreasing monotonically.
C1,C2,..CN	Tabulated points for function C.
T1,T2,..TN	Tabulated points for function T.

**Remarks:**

The tabulated equation of state model is linear in internal energy. Pressure is defined by

$$P = C(\varepsilon_v) + \gamma T(\varepsilon_v) E$$

The volumetric strain,  $\varepsilon_v$  is given by the natural logarithm of the relative volume V. Up to 10 points and as few as 2 may be used when defining the tabulated functions. LS-DYNA will extrapolate to find the pressure if necessary.

# \*EOS

# \*EOS\_PROPELLANT\_DEFLAGRATION

## \*EOS\_PROPELLANT\_DEFLAGRATION

This Equation of state (10) has been added to model airbag propellants.

Card 1            1            2            3            4            5            6            7            8

Variable	EOSID	A	B	XP1	XP2	FRER		
Type	A8	F	F	F	F	F		

Card 2            1            2            3            4            5            6            7            8

Variable	g	R1	R2	R3	R5			
Type	F	F	F	F	F			

Card 3            1            2            3            4            5            6            7            8

Variable	R6	FMXIG	FREQ	GROW1	EM			
Type	F	F	F	F	F			

Card 4            1            2            3            4            5            6            7            8

Variable	AR1	ES1	CVP	CVR	EETAL	CCRIT	ENQ	TMP0
Type	F	F	F	F	F			



Card 5            1            2            3            4            5            6            7            8

Variable	GROW2	AR2	ES2	EN	FMXGR	FMNGR		
Type	F	F	F	F	F	F		

**VARIABLE****DESCRIPTION**

EOSID	Equation of state ID, a unique number or label not exceeding 8 characters must be specified.
A	Product JWL coefficient
B	Product JWL coefficient
XP1	Product JWL coefficient
XP2	Product JWL coefficient
FRER	Unreacted Co-volume
G	Product $\omega C_V$
R1	Unreacted JWL coefficient
R2	Unreacted JWL coefficient
R3	Unreacted $\omega C_V$
R5	Unreacted JWL coefficient
R6	Unreacted JWL coefficient
FMXIG	Initial Fraction Reacted $F_0$
FREQ	Initial Pressure $P_0$
GROW1	First burn rate coefficient
EM	Pressure Exponent (1 <sup>st</sup> term)
AR1	Exponent on F (1 <sup>st</sup> term)
ES1	Exponent on (1-F) (1 <sup>st</sup> term)

<u>VARIABLE</u>	<u>DESCRIPTION</u>
CVP	Heat capacity Cv for products
CVR	Heat capacity Cv for unreacted material
EETAL	Extra, not presently used
CCRIT	Product co-volume
ENQ	Heat of Reaction
TMP0	Initial Temperature (298°K)
GROW2	Second burn rate coefficient
AR2	Exponent on F (2 <sup>nd</sup> term)
ES2	Exponent on (1-F) (2 <sup>nd</sup> term)
EN	Pressure Exponent (2 <sup>nd</sup> term)
FMXGR	Maximum F for 1 <sup>st</sup> term
FMNGR	Minimum F for 2 <sup>nd</sup> term

**Remarks:**

A deflagration (burn rate) reactive flow model requires an unreacted solid equation of state, a reaction product equation of state, a reaction rate law and a mixture rule for the two (or more) species. The mixture rule for the standard ignition and growth model [Lee and Tarver 1980] assumes that both pressures and temperatures are completely equilibrated as the reaction proceeds. However, the mixture rule can be modified to allow no thermal conduction or partial heating of the solid by the reaction product gases. For this relatively slow process of airbag propellant burn, the thermal and pressure equilibrium assumptions are valid. The equations of state currently used in the burn model are the JWL, Gruneisen, the van der Waals co-volume, and the perfect gas law, but other equations of state can be easily implemented. In this propellant burn, the gaseous nitrogen produced by the burning sodium azide obeys the perfect gas law as it fills the airbag but may have to be modeled as a van der Waal's gas at the high pressures and temperatures produced in the propellant chamber. The chemical reaction rate law is pressure, particle geometry and surface area dependant, as are most high-pressure burn processes. When the temperature profile of the reacting system is well known, temperature dependent Arrhenius chemical kinetics can be used.

Since the airbag propellant composition and performance data are company private information, it is very difficult to obtain the required information for burn rate modeling. However, Imperial

Chemical Industries (ICI) Corporation supplied pressure exponent, particle geometry, packing density, heat of reaction, and atmospheric pressure burn rate data which allowed us to develop the numerical model presented here for their  $\text{NaN}_3 + \text{Fe}_2\text{O}_3$  driver airbag propellant. The deflagration model, its implementation, and the results for the ICI propellant are presented in [Hallquist, et.al., 1990].

The unreacted propellant and the reaction product equations of state are both of the form:

$$p = A e^{-R_1 V} + B e^{-R_2 V} + \frac{\omega C_v T}{V - d}$$

where  $p$  is pressure (in Mbars),  $V$  is the relative specific volume (inverse of relative density),  $\omega$  is the Gruneisen coefficient,  $C_v$  is heat capacity (in Mbars-cc/cc°K),  $T$  is temperature in °K,  $d$  is the co-volume, and  $A$ ,  $B$ ,  $R_1$  and  $R_2$  are constants. Setting  $A=B=0$  yields the van der Waal's co-volume equation of state. The JWL equation of state is generally useful at pressures above several kilobars, while the van der Waal's is useful at pressures below that range and above the range for which the perfect gas law holds. Of course, setting  $A=B=d=0$  yields the perfect gas law. If accurate values of  $\omega$  and  $C_v$  plus the correct distribution between "cold" compression and internal energies are used, the calculated temperatures are very reasonable and thus can be used to check propellant performance.

The reaction rate used for the propellant deflagration process is of the form:

$$\frac{\partial F}{\partial t} = Z(1-F)^y F^x p^w + V(1-F)^u Frp^s$$

for  $0 < F < F_{\text{limit}1}$                       for  $F_{\text{limit}2} < F < 1$

where  $F$  is the fraction reacted ( $F = 0$  implies no reaction,  $F = 1$  is complete reaction),  $t$  is time, and  $p$  is pressure (in Mbars),  $r, s, u, w, x, y, F_{\text{limit}1}$  and  $F_{\text{limit}2}$  are constants used to describe the pressure dependence and surface area dependence of the reaction rates. Two (or more) pressure dependant reaction rates are included in case the propellant is a mixture or exhibited a sharp change in reaction rate at some pressure or temperature. Burning surface area dependencies can be approximated using the  $(1-F)^y F^x$  terms. Other forms of the reaction rate law, such as Arrhenius temperature dependent  $e^{-E/RT}$  type rates, can be used, but these require very accurate temperatures calculations. Although the theoretical justification of pressure dependent burn rates at kilobar type pressures is not complete, a vast amount of experimental burn rate versus pressure data does demonstrate this effect and hydrodynamic calculations using pressure dependent burn accurately simulate such experiments.

The deflagration reactive flow model is activated by any pressure or particle velocity increase on one or more zone boundaries in the reactive material. Such an increase creates pressure in those zones and the decomposition begins. If the pressure is relieved, the reaction rate decreases and can go to zero. This feature is important for short duration, partial decomposition reactions. If the pressure is maintained, the fraction reacted eventually reaches one and the material is completely converted to product molecules. The deflagration front rates of advance through the propellant calculated by this model for several propellants are quite close to the experimentally observed burn rate versus pressure curves.

To obtain good agreement with experimental deflagration data, the model requires an accurate description of the unreacted propellant equation of state, either an analytical fit to experimental compression data or an estimated fit based on previous experience with similar materials. This is also true for the reaction products equation of state. The more experimental burn rate, pressure production and energy delivery data available, the better the form and constants in the reaction rate equation can be determined.

Therefore, the equations used in the burn subroutine for the pressure in the unreacted propellant

$$P_u = R1 \cdot e^{-R5 \cdot V_u} + R2 \cdot e^{-R6 \cdot V_u} + \frac{R3 \cdot T_u}{V_u - FRER}$$

where  $V_u$  and  $T_u$  are the relative volume and temperature respectively of the unreacted propellant. The relative density is obviously the inverse of the relative volume. The pressure  $P_p$  in the reaction products is given by:

$$P_p = A \cdot e^{-XP1 \cdot V_p} + B \cdot e^{-XP2 \cdot V_p} + \frac{G \cdot T_p}{V_p - CCRIT}$$

As the reaction proceeds, the unreacted and product pressures and temperatures are assumed to be equilibrated ( $T_u = T_p = T$ ,  $p = P_u = P_p$ ) and the relative volumes are additive:

$$V = (1 - F) \cdot V_u + F \cdot V_p$$

where  $V$  is the total relative volume. Other mixture assumptions can and have been used in different versions of DYNA2D/3D. The reaction rate law has the form:

$$\frac{\partial F}{\partial t} = \text{GROW1}(P + \text{FREQ})^{\text{EM}} (F + \text{FMXIG})^{\text{AR1}} (1 - F + \text{FMXIG})^{\text{ES1}} \\ + \text{GROW2}(P + \text{FREQ})^{\text{EN}} (F + \text{FMXIG})^{\text{AR2}} (1 - F + \text{FMXIG})^{\text{ES2}}$$

If  $F$  exceeds  $\text{FMXGR}$ , the  $\text{GROW1}$  term is set equal to zero, and, if  $F$  is less than  $\text{FMNGR}$ , the  $\text{GROW2}$  term is zero. Thus, two separate (or overlapping) burn rates can be used to describe the rate at which the propellant decomposes.

This equation of state subroutine is used together with a material model to describe the propellant. In the airbag propellant case, a null material model (type #10) can be used. Material type #10 is usually used for a solid propellant or explosive when the shear modulus and yield strength are defined. The propellant material is defined by the material model and the unreacted equation of state until the reaction begins. The calculated mixture states are used until the reaction is complete and then the reaction product equation of state is used. The heat of reaction,  $\text{ENQ}$ , is assumed to be a constant and the same at all values of  $F$  but more complex energy release laws could be implemented.

**\*EOS\_TENSOR\_PORE\_COLLAPSE**

This is Equation of state Form 11.

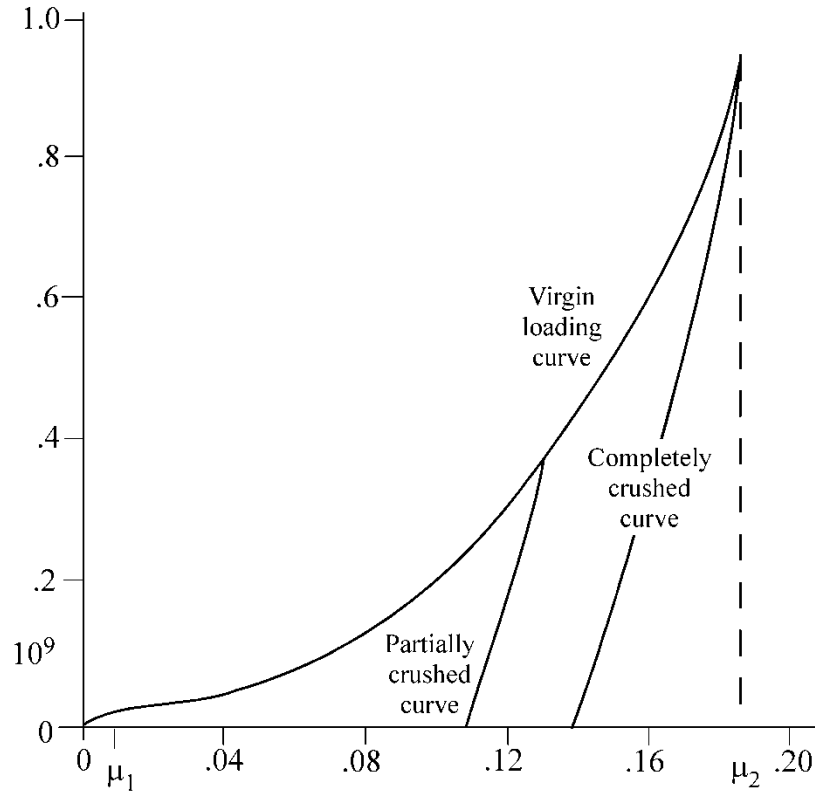
Card 1            1            2            3            4            5            6            7            8

Variable	EOSID	NLD	NCR	MU1	MU2	IE0	EC0	
Type	A8	F	F	F	F	F	F	

<u>VARIABLE</u>	<u>DESCRIPTION</u>
EOSID	Equation of state ID, a unique number or label not exceeding 8 characters must be specified.
NLD	Virgin loading load curve ID
NCR	Completely crushed load curve ID
MU1	Excess Compression required before any pores can collapse
MU2	Excess Compression point where the Virgin Loading Curve and the Completely Crushed Curve intersect
IE0	Initial Internal Energy
EC0	Initial Excess Compression

**Remarks:**

The pore collapse model described in the TENSOR manual [23] is no longer valid and has been replaced by a much simpler method. This is due in part to the lack of experimental data required for the more complex model. It is desired to have a close approximation of the TENSOR model in the DYNA code to enable a quality link between them. The TENSOR model defines two curves, the virgin loading curve and the completely crushed curve as shown in Figure 17.2. It also defines the excess compression required for pore collapse to begin ( $\mu_1$ ), and the excess compression point required to completely crush the material ( $\mu_2$ ). From this data and the maximum excess compression the material has attained ( $\mu_{max}$ ), the pressure for any excess compression ( $\mu$ ) can be determined.



**Figure 17.2.** Pressure versus compaction curve.

Unloading occurs along the virgin loading curve until the excess compression surpasses  $\mu_1$ . After that, the unloading follows a path between the completely crushed curve and the virgin loading curve. Reloading will follow this curve back up to the virgin loading curve. Once the excess compression exceeds  $\mu_2$ , then all unloading will follow the completely crushed curve.

For unloading between  $\mu_1$  and  $\mu_2$  a partially crushed curve is determined by the relationship:

$$P_{pc}(\mu) = P_{cc} \left( \frac{(1 + \mu_B)(1 + \mu)}{1 + \mu_{max}} - 1 \right)$$

where

$$\mu_B = P_{cc}^{-1}(P_{max})$$

and the subscripts pc and cc refer to the partially crushed and completely crushed states, respectively. This is more readily understood in terms of the relative volume ( $V$ ).

$$V = \frac{1}{1 + \mu}$$

$$P_{pc}(V) = P_{cc} \left( \frac{V_B - V}{V_{min}} \right)$$

This representation suggests that for a fixed  $V_{min} \left( = \frac{1}{\mu_{max} + 1} \right)$  the partially crushed curve will separate linearly from the completely crushed curve as  $V$  increases to account for pore recovery in the material.

The bulk modulus  $K$  is determined to be the slope of the current curve times one plus the excess compression

$$K = \frac{\partial P}{\partial \mu} (1 + \mu)$$

The slope  $\frac{\partial P}{\partial \mu}$  for the partially crushed curve is obtained by differentiation as:

$$\frac{\partial P}{\partial \mu} = \frac{\partial P_{cc} \left( \frac{(1 + \mu_B)(1 + \mu)}{1 + \mu_{max}} \right)}{\partial \mu} (1 + \mu_B)$$

Simplifying,

$$K = \frac{\partial P_{cc}(\mu_a)}{\partial \mu} (1 + \mu_a)$$

where

$$\mu_a = \frac{(1 + \mu_B)(1 + \mu)}{1 + \mu_{max}} - 1.$$

The bulk sound speed is determined from the slope of the completely crushed curve at the current pressure to avoid instabilities in the time step.

The virgin loading and completely crushed curves are modeled with monotonic cubic-splines. An optimized vector interpolation scheme is then used to evaluate the cubic-splines. The bulk modulus and sound speed are derived from a linear interpolation on the derivatives of the cubic-splines.

**\*EOS\_IDEAL\_GAS**

Purpose: This is equation of state form 12 for modeling ideal gas. It is an alternate approach to using \*EOS\_LINEAR\_POLYNOMIAL with  $C4 = C5 = (\gamma - 1)$  to model ideal gas. This has a slightly improved energy accounting algorithm.

Card 1            1            2            3            4            5            6            7            8

Variable	EOSID	CV0	CP0	CL	CQ	T0	V0	
Type	A8	F	F	F	F	F	F	

**VARIABLE****DESCRIPTION**

EOSID	Equation of state ID, a unique number or label not exceeding 8 characters must be specified.
CV0	Nominal constant-volume specific heat coefficient (at STP)
CP0	Nominal constant-pressure specific heat coefficient (at STP)
CL	Linear coefficient for the variations of Cv and Cp versus T
CQ	Quadratic coefficient for the variations of Cv and Cp versus T
T0	Initial temperature
V0	Initial relative volume (see the beginning of the *EOS section)

**Remarks:**

1. The pressure in the ideal gas law is defined as

$$p = \rho (C_p - C_v) T$$

$$C_p = C_{p0} + C_L T + C_Q T^2$$

$$C_v = C_{v0} + C_L T + C_Q T^2$$

where  $C_p$  and  $C_v$  are the specific heat capacities at constant pressure and at constant volume, respectively.  $\rho$  is the density. The relative volume, V0 parameter in the input, is defined as



$$v_r = \frac{V}{V_0} = \frac{(V/M)}{(V_0/M)} = \frac{v}{v_0} = \frac{\rho_0}{\rho}$$

where  $\rho_0$  is a nominal or reference density defined in the \*MAT\_NULL card. The initial pressure can then be manually computed as

$$P|_{t=0} = \rho|_{t=0} (C_p - C_v) T|_{t=0}$$

$$\rho|_{t=0} = \left\{ \frac{\rho_0}{v_r|_{t=0}} \right\}$$

$$P|_{t=0} = \left\{ \frac{\rho_0}{v_r|_{t=0}} \right\} (C_p - C_v) T|_{t=0}$$

The initial relative volume,  $v_r|_{t=0}$  (V0), initial temperature,  $T|_{t=0}$  (T0), and heat capacity information are defined in the \*EOS\_IDEAL\_GAS input. Note that the “reference” density is typically a density at a non-stressed or nominal stress state. The initial pressure should always be checked manually against simulation result.

2. When dealing with Eulerian/ALE models, the ideal gas model is implemented to preserve the adiabatic state during advection. The adiabatic state is conserved on the expense of a perfect internal energy conservation.
3. The ideal gas model is good for low density gas only. Deviation from the ideal gas behavior may be indicated by the compressibility factor defined as

$$Z = \frac{Pv}{RT}$$

When Z deviates from 1, the gas behavior deviates from ideal.

4. V0 and T0 defined in this card must be the same as the time-zero ordinates for the 2 load curves defined in the \*BOUNDARY\_AMBIENT\_EOS card, if it is used. This is so that they both would consistently define the same initial state for a material.

**\*EOS\_JWL**

This is Equation of state Form 14. The JWL (Jones-Wilkens-Lee-Baker) equation of state, developed by Baker [1991] and further described by Baker and Orosz [1991], describes the high pressure regime produced by overdriven detonations while retaining the low pressure expansion behavior required for standard acceleration modeling. The derived form of the equation of state is based on the JWL form due to its computational robustness and asymptotic approach to an ideal gas at high expansions. Additional exponential terms and a variable Gruneisen parameter have been added to adequately describe the high-pressure region above the Chapman-Jouguet state.

Card 1            1            2            3            4            5            6            7            8

Variable	EOSID	A1	A2	A3	A4	A5		
Type	A8	F	F	F	F	F		

Card 2            1            2            3            4            5            6            7            8

Variable	R1	R2	R3	R4	R5			
Type	F	F	F	F	F			

Card 3            1            2            3            4            5            6            7            8

Variable	AL1	AL2	AL3	AL4	AL5			
Type	F	F	F	F	F			

Card 4            1            2            3            4            5            6            7            8

Variable	BL1	BL2	BL3	BL4	BL5			
Type	F	F	F	F	F			

Card 5            1            2            3            4            5            6            7            8

Variable	RL1	RL2	RL3	RL4	RL5			
Type	F	F	F	F	F			

Card 6            1            2            3            4            5            6            7            8

Variable	C	OMEGA	E	V0				
Type	I	F	F	F				

<u>VARIABLE</u>	<u>DESCRIPTION</u>
EOSID	Equation of state ID, a unique number or label not exceeding 8 characters must be specified.
A1	Equation of state coefficient, see below.
A2	Equation of state coefficient, see below.
A3	Equation of state coefficient, see below.
A4	Equation of state coefficient, see below.
A5	Equation of state coefficient, see below.
R1	Equation of state coefficient, see below.
R2	Equation of state coefficient, see below.
R3	Equation of state coefficient, see below.
R4	Equation of state coefficient, see below.
R5	Equation of state coefficient, see below.
AL1	$A_{\lambda 1}$ , equation of state coefficient, see below.
AL2	$A_{\lambda 2}$ , equation of state coefficient, see below.
AL3	$A_{\lambda 3}$ , equation of state coefficient, see below.

<b>VARIABLE</b>	<b>DESCRIPTION</b>
AL4	$A_{\lambda 4}$ , equation of state coefficient, see below.
AL5	$A_{\lambda 5}$ , equation of state coefficient, see below.
BL1	$B_{\lambda 1}$ , equation of state coefficient, see below.
BL2	$B_{\lambda 2}$ , equation of state coefficient, see below.
BL3	$B_{\lambda 3}$ , equation of state coefficient, see below.
BL4	$B_{\lambda 4}$ , equation of state coefficient, see below.
BL5	$B_{\lambda 5}$ , equation of state coefficient, see below.
RL1	$R_{\lambda 1}$ , equation of state coefficient, see below.
RL2	$R_{\lambda 2}$ , equation of state coefficient, see below.
RL3	$R_{\lambda 3}$ , equation of state coefficient, see below.
RL4	$R_{\lambda 4}$ , equation of state coefficient, see below.
RL5	$R_{\lambda 5}$ , equation of state coefficient, see below.
C	Equation of state coefficient, see below.
OMEGA	Equation of state coefficient, see below.
E	Energy density per unit initial volume
V0	Initial relative volume.

**Remarks:**

The JWLB equation-of-state defines the pressure as

$$p = \sum_{i=1}^5 A_i \left( 1 - \frac{\lambda}{R_i V} \right) e^{-R_i V} + \frac{\lambda E}{V} + C \left( 1 - \frac{\lambda}{\omega} \right) V^{-(\omega+1)}$$

$$\lambda = \sum_{i=1}^5 (A_{\lambda i} V + B_{\lambda i}) e^{-R_{\lambda i} V} + \omega$$

where  $V$  is the relative volume,  $E$  is the energy per unit initial volume, and  $A_i$ ,  $R_i$ ,  $A_{\lambda i}$ ,  $B_{\lambda i}$ ,  $R_{\lambda i}$ ,  $C$ , and  $\omega$  are input constants defined above.

JWL input constants for some common explosives as found in Baker and Stiel [1997] are given in the following table.

	TATB	LX-14	PETN	TNT	Octol 70/30
$\rho_0$ (g/cc)	1.800	1.821	1.765	1.631	1.803
$E_0$ (Mbar)	.07040	.10205	.10910	.06656	.09590
DCJ (cm/ $\mu$ s)	.76794	.86619	.83041	.67174	.82994
PCJ (Mbar)	.23740	.31717	.29076	.18503	.29369
A1 (Mbar)	550.06	549.60	521.96	490.07	526.83
A2 (Mbar)	22.051	64.066	71.104	56.868	60.579
A3 (Mbar)	.42788	2.0972	4.4774	.82426	.91248
A4 (Mbar)	.28094	.88940	.97725	.00093	.00159
R1	16.688	34.636	44.169	40.713	52.106
R2	6.8050	8.2176	8.7877	9.6754	8.3998
R3	2.0737	20.401	25.072	2.4350	2.1339
R4	2.9754	2.0616	2.2251	.15564	.18592
C (Mbar)	.00776	.01251	.01570	.00710	.00968
$\omega$	.27952	.38375	.32357	.30270	.39023
$A_{\lambda 1}$	1423.9	18307.	12.257	.00000	.011929
$B_{\lambda 1}$	14387.	1390.1	52.404	1098.0	18466.
$R_{\lambda 1}$	19.780	19.309	43.932	15.614	20.029
$A_{\lambda 2}$	5.0364	4.4882	8.6351	11.468	5.4192
$B_{\lambda 2}$	-2.6332	-2.6181	-4.9176	-6.5011	-3.2394
$R_{\lambda 2}$	1.7062	1.5076	2.1303	2.1593	1.5868

**\*EOS\_GASKET**

This model works with solid elements and the thick shell using selective reduced 2 x 2 integration (ELFORM=2 on SECTION\_TSHELL) to model the response of gaskets. For the thick shell only, it is completely decoupled from the shell material, i.e., in the local coordinate system of the shell, this model defines the normal stress,  $\sigma_{zz}$ , and doesn't change any of the other stress components. The model is a reduction of the \*MAT\_GENERAL\_NONLINEAR\_6DOF\_DISCRETE\_BEAM.

Card 1            1            2            3            4            5            6            7            8

Variable	EOSID	LCID1	LCID2	LCID3	LCID4			
Type	A8	I	I	I	I			

Card 2            1            2            3            4            5            6            7            8

Variable	UNLOAD	ET	DMPF	TFS	CFS	LOFFSET	IVS	
Type	F	F	F	F	F	F	F	

**VARIABLE****DESCRIPTION**

EOSID	Equation of state ID, a unique number or label not exceeding 8 characters must be specified.
LCID1	Load curve for loading.
LCID2	Load curve for unloading.
LCID3	Load curve for damping as a function of volumetric strain rate.
LCID4	Load curve for scaling the damping as a function of the volumetric strain.

---

<u>VARIABLE</u>	<u>DESCRIPTION</u>
UNLOAD	Unloading option (See figure 17.3.): EQ.0.0: Loading and unloading follow loading curve EQ.1.0: Loading follows loading curve, unloading follows unloading curve. The unloading curve ID if undefined is taken as the loading curve. EQ.2.0: Loading follows loading curve, unloading follows unloading stiffness, KT or KR, to the unloading curve. The loading and unloading curves may only intersect at the origin of the axes. EQ.3.0: Quadratic unloading from peak displacement value to a permanent offset.
DMPF	Damping factor for stability. Values in the neighborhood of unity are recommended. The damping factor is properly scaled to eliminate time step size dependency. Also, it is active if and only if ET is defined.
TFS	Tensile failure strain.
CFS	Compressive failure strain.
OFFSET	Offset factor between 0 and 1.0 to determine permanent set upon unloading if the UNLOAD=3.0. The permanent sets in compression and tension are equal to the product of this offset value and the maximum compressive and tensile displacements, respectively.
IVS	Initial volume strain.

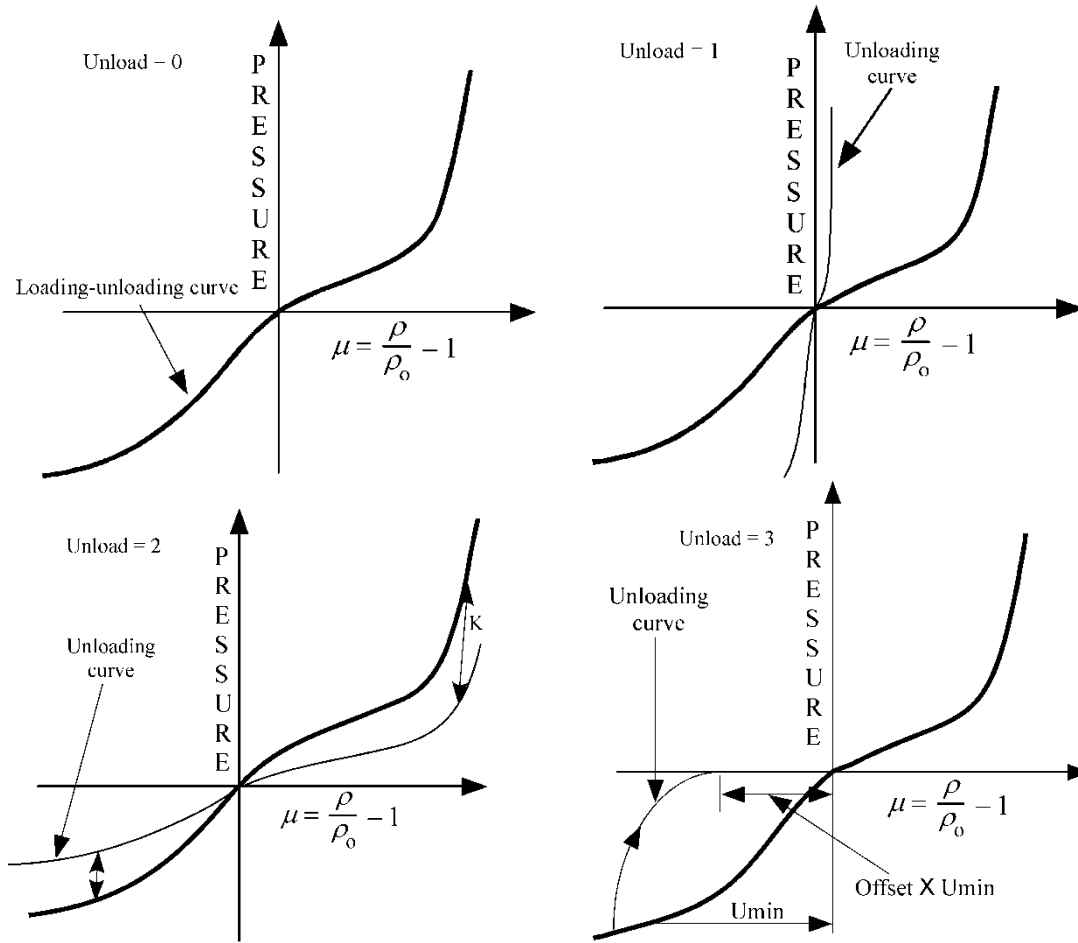


Figure 17.3. Load and Unloading behavior.



\*EOS\_MIE\_GRUNEISEN

This is Equation of state Form 16, a Mie-Gruneisen form with a p- $\alpha$  compaction model.

Card 1            1            2            3            4            5            6            7            8

Variable	EOSID	GAMMA	A1	A2	A3	PEL	PCO	N
Type	A8	F	F	F	F	F	F	F
Default	NONE	NONE	NONE	NONE	NONE	NONE	NONE	NONE

Card 2            1            2            3            4            5            6            7            8

Variable	ALPHA0	E0	V0					
Type	F	F	F					
Default	NONE	NONE	NONE					

<u>VARIABLE</u>	<u>DESCRIPTION</u>
EOSID	Equation of state identification. A unique number or label not exceeding 8 characters must be specified.
GAMMA	Gruneisen gamma.
A1	Hugoniot polynomial coefficient
A2	Hugoniot polynomial coefficient
A3	Hugoniot polynomial coefficient
PEL	Crush pressure
PCO	Compaction pressure
N	Porosity exponent
ALPHA0	Initial porosity

<b>VARIABLE</b>	<b>DESCRIPTION</b>
E0	Initial internal energy
V0	Initial relative volume

**Remarks:**

The equation of state is a Mie-Gruneisen form with a polynomial Hugoniot curve and a p- $\alpha$  compaction model. First, we define a history variable representing the porosity  $\alpha$  that is initialised to  $\alpha_0 > 1$ . The evolution of this variable is given as

$$\alpha(t) = \max \left( 1, \min \left( \alpha_0, \min_{s \leq t} \left( 1 + (\alpha_0 - 1) \left[ \frac{p_{\text{comp}} - p(s)}{p_{\text{comp}} - p_{\text{el}}} \right]^N \right) \right) \right)$$

where  $p(t)$  indicates the pressure at time  $t$ . For later use, we define the cap pressure as

$$p_c = p_{\text{comp}} - (p_{\text{comp}} - p_{\text{el}}) \left[ \frac{\alpha - 1}{\alpha_0 - 1} \right]^{1/N}$$

The remainder of the EOS model is given by the equations

$$p(\rho, e) = \Gamma \alpha \rho e + p_H(\eta) \left[ 1 - \frac{1}{2} \Gamma \eta \right]$$

$$p_H(\eta) = A_1 \eta + A_2 \eta^2 + A_3 \eta^3$$

together with

$$\eta(\rho) = \frac{\alpha \rho}{\alpha_0 \rho_0} - 1.$$

**\*EOS\_USER\_DEFINED**

These are equations of state 21-30. The user can supply his own subroutines. See also Appendix B. The keyword input has to be used for the user interface with data.

Card 1            1            2            3            4            5            6            7            8

Variable	EOSID	EOST	LMC	NHV	IVECT	EO	VO	BULK
Type	A8	I	I	I	I	F	F	F

**Define LMC material parameters using 8 parameters per card.**

Card 2            1            2            3            4            5            6            7            8

Variable	P1	P2	P3	P4	P5	P6	P7	P8
Type	F	F	F	F	F	F	F	F

<u>VARIABLE</u>	<u>DESCRIPTION</u>
EOSID	Equation of state ID, a unique number or label not exceeding 8 characters must be specified.
EOST	User equation of state type (21-30 inclusive). A number between 21 and 30 has to be chosen.
LMC	Length of material constant array which is equal to the number of material constants to be input. (LMC ≤ 48)
NHV	Number of history variables to be stored, see Appendix D.
IVECT	Vectorization flag (on=1). A vectorized user subroutine must be supplied.
EO	Initial internal energy.
VO	Initial relative volume.
BULK	Bulk modulus. This value is used in the calculation of the contact surface stiffness.

<u>VARIABLE</u>	<u>DESCRIPTION</u>
P1	First material parameter.
P2	Second material parameter.
P3	Third material parameter.
P4	Fourth material parameter.
.	.
.	.
.	.
PLMC	LMCth material parameter.

# **\*FREQUENCY\_DOMAIN**

Purpose: The keyword **\*FREQUENCY\_DOMAIN** provides a way of defining and solving frequency domain vibration and acoustic problems. The keyword cards in this section are defined in alphabetical order:

**\*FREQUENCY\_DOMAIN\_ACOUSTIC\_BEM\_{OPTION}**

**\*FREQUENCY\_DOMAIN\_ACOUSTIC\_FEM**

**\*FREQUENCY\_DOMAIN\_FRF**

**\*FREQUENCY\_DOMAIN\_RANDOM\_VIBRATION**

**\*FREQUENCY\_DOMAIN\_RESPONSE\_SPECTRUM**

**\*FREQUENCY\_DOMAIN\_SSD**

# \*FREQUENCY\_DOMAIN \*FREQUENCY\_DOMAIN\_ACOUSTIC\_BEM

\*FREQUENCY\_DOMAIN\_ACOUSTIC\_BEM\_{OPTION}

Available options include:

## PANEL\_CONTRIBUTION

Purpose: Use boundary element method in frequency domain for acoustic problems. This Keyword is only used if the option BEM = **filename** in the LSDYNA run command is used:

LS-DYNA I=**inf** BEM=**filename**

Card 1            1            2            3            4            5            6            7            8

Variable	RO	C	FMIN	FMAX	NFREQ	DTOUT	TSTART	PREF
Type	F	F	F	F	I	F	F	F
Default	none	none	none	none	0	0	0	0
Remark							1	2

Card 2            1            2            3            4            5            6            7            8

Variable	NSIDEXT	TYPEXT	NSIDINT	TYPINT	FFTWIN	TRSLT	IPFILE	IUNITS
Type	I	I	I	I	I	I	I	I
Default	0	0	0	0	0	0	0	0
Remark					3	4		5

**\*FREQUENCY\_DOMAIN\_ACOUSTIC\_BEM \*FREQUENCY\_DOMAIN**

Card 3            1            2            3            4            5            6            7            8

Variable	METHOD	MAXIT	TOLITR	NDD	TOLLR	TOLFCT	IBDIM	NPG
Type	I	I	F	I	F	F	I	I
Default		100	10-4	1	10-6	10-6	1000	2
Remark	6			7				

Card 4            1            2            3            4            5            6            7            8

Variable	SSID	SSTYPE	NORM	BEMTYP	RESTRT	IEDGE	NOEL	NFRUP
Type	I	I	I	I	I	I	I	I
Default	0	0	0	0	0	0	0	0
Remark					8	9	10	11

**Card 5 is optional and can be defined multiple times if needed.**

Card 5            1            2            3            4            5            6            7            8

Variable	SSID	SSTYPE	NORM	BEMTYP	LC1	LC2		
Type	I	I	I	I	I	I		
Default	0	0	0	0				
Remark	12							

# \*FREQUENCY\_DOMAIN \*FREQUENCY\_DOMAIN\_ACOUSTIC\_BEM

**Additional card defined only for PANEL CONTRIBUTION option.**

Card            1            2            3            4            5            6            7            8

Variable	NSIDPC							
Type	I							
Default	0							
Remark	13							

## VARIABLE

## DESCRIPTION

RO	Fluid density.
C	Sound speed of the fluid.
FMIN	Minimum value of output frequencies.
FMAX	Maximum value of output frequencies.
NFREQ	Number of output frequencies.
DTOUT	Time interval between writing velocity or acceleration, and pressure at boundary elements in the binary file, to be proceeded at the end of LS-DYNA simulation.
TSTART	Start time for recording velocity or acceleration in LS-DYNA simulation.
PREF	Reference pressure to be used to output pressure in dB, in the file Press_dB. If PREF=0, the Press_dB file will not be generated. A file called Press_Pa is generated and contains the pressure at the output nodes (see Card 2).
NSIDEXT	Node or segment set ID of output exterior field points.
TYPEXT	Output exterior field point type. EQ.1: node set ID. EQ.2: segment set ID.
NSIDINT	Node or segment set ID of output interior field points.



<b>VARIABLE</b>	<b>DESCRIPTION</b>
TYPINT	Output interior field point type. EQ.1: node set ID. EQ.2: segment set ID.
FFTWIN	FFT windows (Default=0). EQ.0: rectangular window. EQ.1: Hanning window. EQ.2: Hamming window. EQ.3: Blackman window. EQ.4: raised cosine window.
TRSLT	Request time domain results: EQ.0: no time domain results are requested. EQ.1: time domain results are requested.
IPFILE	Flag for output files (default=0): EQ.0: Press_Pa (magnitude of pressure vs. frequency), Press_dB (sound pressure level vs. frequency) and bepres (ASCII database file for LS-Prepost) are provided. EQ.1: Press_Pa_real (the real part of the pressure vs. frequency) and Press_Pa_imag (the imaginary part of the pressure vs. frequency) are provided, in addition to Press_Pa, Press_dB and bepres. EQ.10: files for IPFILE=0, and fringe files for acoustic pressure. EQ.11: files for IPFILE=1, and fringe files for acoustic pressure. EQ.20: files for IPFILE=0, and fringe files for sound pressure level. EQ.21: files for IPFILE=1, and fringe files for sound pressure level.
IUNITS	Flag for unit changes EQ.0: do not apply unit change. EQ.1: MKS units are used, no change needed. EQ.2: units (lbf×s <sup>2</sup> /in, inch, s, lbf, psi, etc.) are used, changed to MKS in BEM Acoustic computation. EQ.3: units (kg, mm, ms, kN, GPa, etc.) are used, changed to MKS in BEM acoustic computation. EQ.4: units (ton, mm, s, N, MPa, etc.) are used, changed to MKS in BEM acoustic computation.

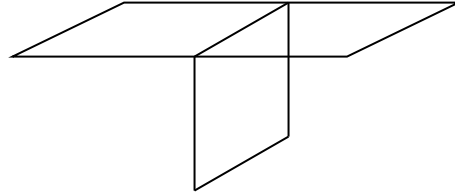
<u>VARIABLE</u>	<u>DESCRIPTION</u>
METHOD	Method used in acoustic analysis EQ.0: Rayleigh method (very fast). EQ.1: Kirchhoff method coupled to FEM for acoustics (*MAT_ACOUSTIC) (see Remark 6). EQ.2: variational Indirect BEM. EQ.3: collocation BEM. EQ.4: collocation BEM with Burton-Miller formulation for exterior problems (no irregular frequency phenomenon).
MAXIT	Maximum number of iterations for iterative solver (default =100) if METHOD $\geq$ 2.
TOLITR	Tolerance for the iterative solver (default=1.E-4).
NDD	Number of domain decomposition, used for memory saving. For large problems, the boundary mesh is decomposed into NDD domains for less memory allocation. This option is only used if METHOD $\geq$ 2.
TOLLR	Tolerance for low rank approximation of dense matrix (default=1.E-6).
TOLFACT	Tolerance in factorization of the low rank matrix (default=1.E-6).
IBDIM	Inner iteration limit in GMRES iterative solver (default=1000).
NPG	Number of Gauss integration points (default=2).
SSID	Part, part set ID, or segment set ID of boundary elements.
SSTYPE	Boundary element type: EQ.0: part Set ID EQ.1: part ID EQ.2: segment set ID.
NORM	NORM should be set such that the normal vectors point away from the fluid. EQ.0: normal vectors are not inverted (default). EQ.1: normal vectors are inverted.

<b>VARIABLE</b>	<b>DESCRIPTION</b>
BEMTYP	Type of input boundary values in BEM analysis. EQ.0: boundary velocity will be processed in BEM analysis. EQ.1: boundary acceleration will be processed in BEM analysis. EQ.2: pressure is prescribed and the real and imaginary parts are given by LC1 and LC2. EQ.3: normal velocity is prescribed and the real and imaginary parts are given by LC1 and LC2. EQ.4: impedance is prescribed and the real and imaginary parts are given by LC1 and LC2. EQ.-n: normal velocity (only real part) is prescribed, through load curve n. An amplitude versus. frequency load curve (with curve ID n) needs to be defined.
RESTRT	This flag is used to save an LS-DYNA analysis if the binary output file in the (bem=filename) option has not been changed (default = 0). EQ.0: LS-DYNA analysis is processed and generates a new binary file. EQ.1: LS-DYNA analysis is not processed. The binary file from previous run is used.
IEDGE	Free edge and multi-connection constraints option (default = 0). EQ.0: free edge and multi-connection constraints not considered. EQ.1: free edge and multi-connection constraints considered. EQ.2: only free edge constraints are considered. EQ.3: only multi-connection constraints are considered.
NOEL	Location where normal velocity or acceleration is taken (default = 0). EQ.0: elements or segments. EQ.1: nodes.
NFRUP	Preconditioner update option. EQ.0: updated at every frequency. EQ.N: updated for every N frequencies.
LC1	Load curve ID for defining real part of pressure, normal velocity or impedance.
LC2	Load curve ID for defining imaginary part of pressure, normal velocity or impedance.
NSIDPC	Node set ID for the field points where panel contributions to SPL (Sound Pressure Level) are requested.

**Remarks:**

1. TSTART indicates the time at which velocity or acceleration and pressure are stored in the binary file.
2. This reference pressure is required for the computation of the pressure in dB. Usually, in International Unit System the reference pressure is 20 micro\_Pascal.
3. Velocity or acceleration (pressure) is provided by LS-DYNA analysis. They are written in a binary file (bem= filename). The boundary element method is processed after the LS-DYNA analysis. An FFT algorithm is used to transform time domain data into frequency domain in order to use the boundary element method for acoustics. In order to overcome the FFT leakage problem due to the truncation of the temporal response, several windows are proposed. Windowing is used to have a periodic velocity, acceleration and pressure in order to use the FFT.
4. If time domain results are requested, FMIN is changed to 0 in the code.
5. We change units used in BEM computation to international units (kg, m, s, N, Pa) so that the reference pressure will not be too small. For example, it can be 20.E-15 GPa if one uses the units (kg, mm, ms, kN, GPa) and this may pose potential truncation error in the computation, especially in single precision version.
6. Rayleigh method represents an approximation for the BEM. It is very fast since there is no linear system to solve. It can only be used for external radiation problem. Kirchhoff method is a coupling between BEM and FEM for acoustics (\*MAT\_ACOUSTIC) with Non Reflecting Boundary condition, see \*BOUNDARY\_NON\_REFLECTING. In this case, at least one fluid layer with non reflecting boundary condition is to be merged to the vibrating structure. This additional fluid is given in \*MAT\_ACOUSTIC by the same density and sound speed as used in this keyword. Both methods constitute a good approximation of BEM for external problems.
7. BEM formulation for large and medium size problems (more than 2000 boundary elements) is memory and time consuming. In this case, user may run LS-DYNA using the memory option. In order to save memory, domain decomposition can be used.
8. The binary file generated by a previous run can be used for the next run by using the restart option. The restart option allows the user to use the binary file generated from a previous calculation in order to run BEM. In this case, the frequency range can be changed. User should keep the same time parameters as in previous calculation.
9. IEDGE option only applies to METHOD=2, the Variational Indirect BEM.
10. NOEL decides if the elemental or nodal velocity (or acceleration) is taken from FEM computation. NOEL should be 0 if Kirchhoff method (METHOD=1) is used since elemental pressure is processed in FEM. NOEL should be 0 if Burton-Miller collocation method (METHOD=4) is used since a constant strength element

formulation is adopted. In other cases, it is strongly recommended to use element velocity or acceleration (NOEL=0) if “T-Section” appears in boundary element mesh.



**Figure 18.1** T-section

11. The preconditioner is obtained with the factorization of the influence coefficient matrix. It can be retained for several frequencies, to save CPU time. By default (NFRUP=0), the preconditioner is updated for every frequency. Note that in MPP version, the preconditioner is updated every NFRUP frequencies on each processor.
12. The Card 5 can be defined if the boundary elements are composed of several panels. It can be defined multiple times if more than 2 panels are used. Each card 5 defines one panel.
13. The field points where the panel contribution analysis are requested must be one of the field points for acoustic computation (it must be included in the nodes specified by the NSIDEXT or NSIDINT). The panels are defined by card 4 and card 5, etc. Each card defines one panel.
14. Please note that in order to get accurate results, the element size should not be greater than 1/6 of the wave length  $\lambda$  ( $\lambda=c/f$  where  $c$  is the wave speed and  $f$  is the frequency).

# \*FREQUENCY\_DOMAIN \*FREQUENCY\_DOMAIN\_ACOUSTIC\_FEM

## \*FREQUENCY\_DOMAIN\_ACOUSTIC\_FEM

Purpose: Define an interior acoustic problem and solve the problem with a frequency domain finite element method.

Card 1            1            2            3            4            5            6            7            8

Variable	RO	C	FMIN	FMAX	NFREQ	DTOUT	TSTART	PREF
Type	F	F	F	F	I	F	F	F
Default	none	none	none	none	0	0	0	0

Card 2            1            2            3            4            5            6            7            8

Variable	PID	PTYP						
Type	I	I						
Default	none	0						

Card 3            1            2            3            4            5            6            7            8

Variable	SID	STYP	VAD	DOF	LCID1	LCID2	SF	VID
Type	I	I	I	I	I	I	F	I
Default	none	0	0	none	0	0	1.0	0

**\*FREQUENCY\_DOMAIN\_ACOUSTIC\_FEM      \*FREQUENCY\_DOMAIN**

Card 4            1            2            3            4            5            6            7            8

Variable	NID	NTYP	IPFILE					
Type	I	I	I					
Default	none	0	0					

**VARIABLE**

**DESCRIPTION**

RO	Fluid density.
C	Sound speed of the fluid.
FMIN	Minimum value of output frequencies.
FMAX	Maximum value of output frequencies.
NFREQ	Number of output frequencies.
DTOUT	Time step for writing velocity or acceleration in the binary file.
TSTART	Start time for recording velocity or acceleration in transient analysis.
PREF	Reference pressure, for converting the acoustic pressure to dB.
PID	Part ID, or part set ID to define the acoustic domain.
PTYP	Set type: EQ.0: part, see *PART. EQ.1: part set, see *SET_PART.
SID	Part ID, or part set ID, or segment set ID, or node set ID to define the boundary where vibration boundary condition is provided
STYP	Set type: EQ.0: part, see *PART. EQ.1: part set, see *SET_PART. EQ.2: segment set, see *SET_SEGMENT. EQ.3: node set, see *SET_NODE.

# **\*FREQUENCY\_DOMAIN**    **\*FREQUENCY\_DOMAIN\_ACOUSTIC\_FEM**

---

<b>VARIABLE</b>	<b>DESCRIPTION</b>
VAD	Velocity/Acceleration/Displacement flag: EQ.0: velocity by steady state dynamics (SSD). EQ.11: velocity by LCID1 (amplitude) and LCID2 (phase). EQ.12: velocity by LCID1 (real) and LCID2 (imaginary). EQ.21: acceleration by LCID1 (amplitude) and LCID2 (phase). EQ.22: acceleration by LCID1 (real) and LCID2 (imaginary). EQ.31: displacement by LCID1 (amplitude) and LCID2 (phase). EQ.32: displacement by LCID1 (real) and LCID2 (imaginary).
DOF	Applicable degrees-of-freedom: EQ.0: determined by steady state dynamics. EQ.1: x-translational degree-of-freedom, EQ.2: y-translational degree-of-freedom, EQ.3: z-translational degree-of-freedom, EQ.4: translational motion in direction given by VID, EQ.5: normal direction of the element or segment.
LCID1	Load curve ID to describe the amplitude (or real part) of velocity, see *DEFINE_CURVE.
LCID2	Load curve ID to describe the phase (or imaginary part) of velocity, see *DEFINE_CURVE.
SF	Load curve scale factor.
VID	Vector ID for DOF values of 4.
NID	Node ID, or node set ID, or segment set ID for acoustic result output.
NTYP	Set type: EQ.0: Node, see *NODE. EQ.1: Node set, see *SET_NODE.
IPFILE	Flag for output files (default=0): EQ.0: Press_Pa (magnitude of pressure vs. frequency), Press_dB (sound pressure level vs. frequency) are provided. EQ.1: Press_Pa_real (real part of pressure vs. frequency) and Press_Pa_imag (imaginary part of pressure vs. frequency) are provided, in addition to Press_Pa, Press_dB.



**Remarks:**

1. This command solves the interior acoustic problems which is governed by Helmholtz equation  $\nabla^2 p + k^2 p = 0$  with the boundary condition  $\frac{\partial p}{\partial n} = -i\omega\rho v_n$ , where,  $p$  is the acoustic pressure;  $k = \omega / c$  is the wave number;  $\omega$  is the round frequency;  $c$  is the acoustic wave speed (sound speed);  $i = \sqrt{-1}$  is the imaginary unit;  $\rho$  is the mass density and  $v_n$  is the normal velocity. This command solves the acoustic problem in frequency domain.
2. If mass density RO is not given, the mass density of PID (the part which defines the acoustic domain), will be used
3. PREF is the reference pressure to convert the acoustic pressure to dB  $L_p = 10 \log_{10} \frac{p^2}{p_{ref}^2}$   
Note that generally  $p_{ref} = 20 \mu\text{Pa}$  for air.
4. If the boundary velocity is obtained from steady state dynamics (VAD=0) using the keyword \*FREQUENCY\_DOMAIN\_SSD, the part (PID) which defines the acoustic domain has to use one of the following material models,

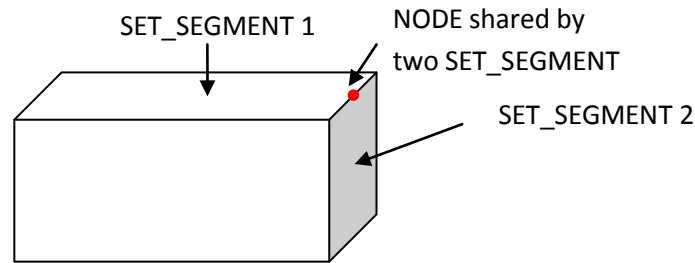
MAT\_ELASTIC\_FLUID

MAT\_NULL (and EOS\_IDEAL\_GAS)

Since only the above material models enable implicit eigenvalue analysis. If the boundary excitation is given by load curves LCID1 and LCID2 (VAD>0), the part (PID) which defines the acoustic domain can use any material model which is compatible with 8-node solid elements, as only the mesh of the PID will be utilized in the computation. For example, MAT\_ACOUSTIC and MAT\_ELASTIC\_FLUID can be used.

5. If VAD=0, the boundary excitation is given as velocity obtained from steady state dynamics. The other parameters in Card 3 (DOF, LCID1, LCID2, SF and VID) are ignored.
6. If a node's vibration boundary condition is defined multiple times, only the last definition is considered. This happens usually when a node is on edge and shared by two or more

PART, SET\_PART, SET\_NODE, or SET\_SEGMENT and different vibration condition is defined on each of the SET\_NODE or SET\_SEGMENT.



**Figure 18.2** Nodes shared by two SET\_SEGMENT

7. Results including acoustic pressure and SPL are given in d3acs binary files, which can be accessed by LS-PrePost. Nodal pressure and SPL values for nodes specified by NID and NTYP are given in ASCII file Press\_Pa and Press\_dB, which can be accessed by LS-PrePost. Press\_Pa gives magnitude of the pressure. Press\_dB gives Sound Pressure Level in terms of dB.
8. If the boundary velocity condition is given by Steady State Dynamics (VAD=0), the range and number of frequencies (FMIN, FMAX and NFREQ) should be compatible with the corresponding parameters in Card 1 of the keyword \*FREQUENCY\_DOMAIN\_SSD

**\*FREQUENCY\_DOMAIN\_FRF****\*FREQUENCY\_DOMAIN****\*FREQUENCY\_DOMAIN\_FRF**

Purpose: Set FRF (frequency domain function) controls.

Card 1            1            2            3            4            5            6            7            8

Variable	N1	N1TYP	DOF1	VAD1	VID	FNMAX	MDMIN	MDMAX
Type	I	I	I	I	I	F	I	I
Default	none	0	none	3	0	0.0	0	0

Card 2            1            2            3            4            5            6            7            8

Variable	DAMPF	LCDAM	LCTYP	DMPMAS	DMPSTF			
Type	F	I	I	F	F			
Default	0.0	0	0	0.0	0.0			

Card 3            1            2            3            4            5            6            7            8

Variable	N2	N2TYP	DOF2	VAD2				
Type	I	I	I	I				
Default	none	0	none	2				

# \*FREQUENCY\_DOMAIN

\*FREQUENCY\_DOMAIN\_FRF

Card 4            1            2            3            4            5            6            7            8

Variable	FMIN	FMAX	NFREQ	FSPACE	LCFREQ	RESTRT	OUTPUT	
Type	F	F	I	I	I	I	I	
Default	none	none	2	0	none	0	0	

## VARIABLE

## DESCRIPTION

N1	Node / Node set/Segment set ID for excitation input.
N1TYP	Type of N1: EQ.0: node ID, EQ.1: node set ID, EQ.2: segment set ID.
DOF1	Applicable degrees-of-freedom for excitation input: EQ. ±1: x-translational degree-of-freedom (positive or negative), EQ. ±2: y-translational degree-of-freedom (positive or negative), EQ. ±3: z-translational degree-of-freedom (positive or negative), EQ. ±4: translational movement in direction given by vector VID (positive or negative).
VAD1	Excitation input type: EQ.0: base velocity, EQ.1: base acceleration, EQ.2: base displacement, EQ.3: nodal force, EQ.4: pressure.
VID	Vector ID for DOF1=4 for excitation input, see *DEFINE_VECTOR.
FNMAX	Optional maximum natural frequency employed in FRF computation.
MDMIN	The first mode employed in FRF computation (optional).
MDMAX	The last mode employed in FRF computation (optional).
DAMPF	Modal damping coefficient, $\zeta$ .
LCDAM	Load Curve ID defining mode dependent modal damping coefficient $\zeta$ .

---

<b>VARIABLE</b>	<b>DESCRIPTION</b>
LCTYP	Type of load curve defining modal damping coefficient: EQ.0: Abscissa value defines frequency, EQ.1: Abscissa value defines mode number.
DMPMAS	Mass proportional damping constant $\alpha$ , in Rayleigh damping.
DMPSTF	Stiffness proportional damping constant $\beta$ , in Rayleigh damping..
N2	Node / Node set/Segment set ID for response output.
N2TYP	Type of N2: EQ.0: node ID, EQ.1: node set ID, EQ.2: segment set ID.
DOF2	Applicable degrees-of-freedom for response output: EQ.1: x-translational degree-of-freedom, EQ.2: y-translational degree-of-freedom, EQ.3: z-translational degree-of-freedom.
VAD2	Response output type: EQ.0: velocity, EQ.1: acceleration, EQ.2: displacement.
FMIN	Minimum frequency for FRF output (cycles/time).
FMAX	Maximum frequency for FRF output (cycles/time).
NFREQ	Number of frequencies for FRF output.
FSPACE	Frequency spacing option for FRF output: EQ.0: linear, EQ.1: logarithmic, EQ.2: biased.
LCFREQ	Load Curve ID defining the frequencies for FRF output.
RESTRT	Restart option. EQ.0: initial run, EQ.1: restart with d3eigv family files, EQ.2: restart with dumpfrf, EQ.3: restart with d3eigv family files and dumpfrf.

---

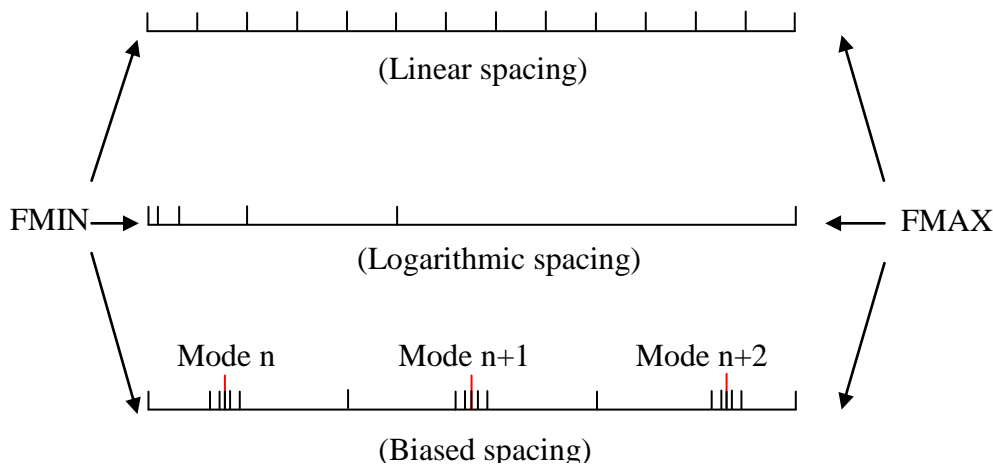
<u>VARIABLE</u>	<u>DESCRIPTION</u>
OUTPUT	Output option. EQ.0: write amplitude and phase angle pairs, EQ.1: write real and imaginary pairs.

---

**Remarks:**

1. This command computes frequency response functions due to nodal excitations.
2. Natural frequencies and mode shapes are needed for computing the frequency response functions. Thus, keyword \*CONTROL\_IMPLICIT\_EIGENVALUE has to be included in input.
3. The FRF (frequency response functions) can be given as Displacement/Force (called Admittance, Compliance, or Receptance), Velocity/Force (called Mobility), Acceleration/Force (called Accelerance, Inertance).
4. FNMAX decides how many natural vibration modes are adopted in FRF computation. LS-DYNA uses only modes with lower or equal frequency than FNMAX in FRF computation. If FNMAX is not given, the number of modes in FRF computation is same as the number of modes, NEIG, from the \*CONTROL\_IMPLICIT\_EIGENVALUE keyword card, unless MDMIN and MDMAX are prescribed (see remark 5).
5. MDMIN and MDMAX decides which mode(s) are adopted in FRF computation. This option is useful for calculating the contribution from a single mode (MDMIN = MDMAX) or several modes (MDMIN < MDMAX). If only MDMIN is given, LS-DYNA use the single mode (MDMIN) to compute FRF.
6. Damping can be prescribed in several ways:
  - To use a constant modal damping coefficient  $\zeta$  for all the modes, define DAMPF only. LCDMP, LCTYP, DMPMAS and DMPSTF are ignored.
  - To use mode dependent modal damping, define a load curve (\*DEFINE\_CURVE) and specify that if the abscissa value defines the frequency or mode number by LCTYP. DMPMAS and DMPSTF are ignored.
  - To use Rayleigh damping, define DMPMAS ( $\alpha$ ) and DMPSTF ( $\beta$ ) and keep DAMPF as 0.0, and keep LCDMP, LCTYP as 0. The damping matrix in Rayleigh damping is defined as  $C = \alpha M + \beta K$ , where, C, M and K are the damping, mass and stiffness matrices respectively.
7. There are two methods to define the frequencies.

The first method is to define FMIN, FMAX, NFREQ and FSPACE. FMIN and FMAX specify the frequency range of interest and NFREQ specifies the number of frequencies at which results are required. FSPACE specifies the type of frequency spacing (linear, logarithmic or biased) to be used. These frequency points for which results are required can be spaced equally along the frequency axis (on a linear or logarithmic scale). Or they can be biased toward the eigenfrequencies (the frequency points are placed closer together at eigenfrequencies in the frequency range) so that the detailed definition of the response close to resonance frequencies can be obtained.



**Figure 18.3.** Spacing options of the frequency points

The second method is to use a load curve (LCFREQ) to define the frequencies of interest.

8. To save time in subsequent runs, user can use the restart option by setting RESTRT=1. LS-DYNA will skip the mode analysis and use d3eigv family files generated in the first run, to compute FRF.
9. RESTRT=2 or 3 is used when user wants to add extra vibration modes to FRF computation. After initial FRF computation, user may find that the number of vibration modes is not enough. For example, in the initial computation, user may use only vibration modes up to 500 Hz. Later it is found that vibration modes at higher frequencies are needed. Then it would be more efficient to just compute the extra modes (frequencies above 500 Hz), and add the contribution from these extra modes to the previous FRF results. In this case, user may use the option RESTRT=2 or 3. For RESTRT=2, LS-DYNA runs a new modal analysis, reads in the previous FRF results (stored in the binary dump file dumpfrf) and add the contribution from the new modes. For RESTRT=3, LS-DYNA reads in d3eigv family files generated elsewhere and reads in also dumpfrf, and add the contribution from the new modes.
10. For excitation given as base acceleration (VAD1=1), the parameters N1, N1TYP are not used and can be blank.

# **\*FREQUENCY\_DOMAIN\***\*FREQUENCY\_DOMAIN\_RANDOM\_VIBRATION

## **\*FREQUENCY\_DOMAIN\_RANDOM\_VIBRATION**

Available options include:

**<BLANK>**

**FATIGUE**

Purpose: Set random vibration control options. When FATIGUE option is used, compute fatigue life of structures or parts under random vibration.

Card 1            1            2            3            4            5            6            7            8

Variable	MDMIN	MDMAX	FNMIN	FNMAX	RESTRT	MFTG		
Type	I	I	F	F	I	I		
Default	1		0.0		0	0		

Card 2            1            2            3            4            5            6            7            8

Variable	DAMPF	LCDAM	LCTYP	DMPMAS	DMPSTF	DMPTYP		
Type	F	I	I	F	F	I		
Default	0.0	0	0	0.0	0.0	0		

Card 3            1            2            3            4            5            6            7            8

Variable	VAFLAG	METHOD	UNIT	UMLT	VAPSD	VARMS	NPSD	NFTG
Type	I	I	I	F	I	I	I	I
Default	none	0					1	1



**\*FREQUENCY\_DOMAIN\_RANDOM\_VIBRATION\*FREQUENCY\_DOMAIN**

Card 4            1            2            3            4            5            6            7            8

Variable	LDTYP	IPANELU	IPANELV	TEMPER	TEXPOS	DSFLAG	SNTYPE	SNLIMT
Type	I	I	I	F	F	I	I	I
Default				0.0	0.	0	0	0

**Repeat Card 5 “NPSD” times if multiple excitations are present.**

Card 5            1            2            3            4            5            6            7            8

Variable	SID	STYPE	DOF	LDPSD	LDVEL	LDFLW	LDSPN	CID
Type	I	I	I	I	I	I	I	I

**Define Card 6 if option FATIGUE is used.**

**Repeat card 6 “NFTG” times if multiple S-N fatigue curves are present**

Card 6	1	2	3	4	5	6	7	8
Variable	PID	LCID	PTYPE	LTYPE	A	B	STHRES	
Type	I	I	I	I	F	F	F	
Default			0	0			0.	

<u>VARIABLE</u>	<u>DESCRIPTION</u>
MDMIN	The first mode in modal superposition method (optional).
MDMAX	The last mode in modal superposition method (optional).
FNMIN	The minimum natural frequency in modal superposition Method (optional).
FNMAX	The maximum natural frequency in modal superposition method (optional).

# **\*FREQUENCY\_DOMAIN\*****FREQUENCY\_DOMAIN\_RANDOM\_VIBRATION**

---

<b>VARIABLE</b>	<b>DESCRIPTION</b>
RESTRT	Restart option. EQ.0: A new modal analysis is performed, EQ.1: Restart with d3eigv.
MFTG	Method for random fatigue analysis (for option _FATIGUE). EQ.0: no fatigue analysis, EQ.1: Steinberg's three-band method, EQ.2: Dirlik method.
DAMPF	Modal damping coefficient, $\zeta$ .
LCDAM	Load Curve ID defining mode dependent modal damping coefficient $\zeta$ .
LCTYP	Type of load curve defining modal damping coefficient EQ.0: Abscissa value defines frequency, EQ.1: Abscissa value defines mode number.
DMPMAS	Mass proportional damping constant $\alpha$ , in Rayleigh damping.
DMPSTF	Stiffness proportional damping constant $\beta$ , in Rayleigh damping.
DMPTYP	Type of damping EQ.0: modal damping. EQ.1: broadband damping.
VAFLAG	Loading type: EQ.0: No random vibration analysis. EQ.1: Base acceleration. EQ.2: Random pressure. EQ.3: Plane wave. EQ.4: Shock wave. EQ.5: Progressive wave. EQ.6: Reverberant wave. EQ.7: Turbulent boundary layer wave. EQ.8: Nodal force.
METHOD	method for modal response analysis. EQ.0: method set automatically by LS-DYNA (recommended) EQ.1: modal superposition method EQ.2: modal acceleration method EQ.3: modal truncation augmentation method

# **\*FREQUENCY\_DOMAIN\_RANDOM\_VIBRATION\*FREQUENCY\_DOMAIN**

---

<b>VARIABLE</b>	<b>DESCRIPTION</b>
UNIT	Flag for acceleration unit conversion: EQ.0: use [length unit]/[time unit] <sup>2</sup> as unit of acceleration. EQ.1: use g as unit for acceleration, and SI units (Newton, kg, meter, second, etc.) elsewhere. EQ.2: use g as unit for acceleration, and Engineering units (lbf, lbf×second <sup>2</sup> /inch, inch, second, etc.) elsewhere. EQ.3: use g as unit for acceleration and provide the multiplier for converting g to [length unit]/[time unit] <sup>2</sup> .
UMLT	Multiplier for converting g to [length unit]/[time unit] <sup>2</sup> .
VAPSD	Flag for PSD output: EQ.0: Absolute PSD output is requested. EQ.1: Relative PSD output is requested (used only for VAFLAG=1)
VARMS	Flag for RMS output: EQ.0: Absolute RMS output is requested. EQ.1: Relative RMS output is requested (used only for VAFLAG=1)
NPSD	Number of PSD load definition. Card 6 is repeated “NPSD” number of times, one for each PSD load definition. The default value is 1.
NFTG	Number of S-N fatigue curve definition. Card 7 is repeated “NFTG” number of times, one for each S-N fatigue curve definition. The default value is 1. If the option {FATIGUE} is not used, ignore this parameter.
LDTYP	Excitation load (LDPSD in card 6) type: EQ.0: PSD. EQ.1: SPL (for plane wave only). EQ.2: time history load.
IPANELU	Number of strips in U direction (used only for VAFLAG=5, 6, 7)
IPANELV	Number of strips in V direction (used only for VAFLAG=5, 6, 7)
TEMPER	Temperature
TEXPOS	Exposure time (used if option FATIGUE is used)
DSFLAG	FLAG for including displacement (and velocity and acceleration), stress and strain results. EQ.0: include only displacement, velocity and acceleration, EQ.1: include displacement, velocity, acceleration and stress, EQ.2: include displacement, velocity, acceleration, stress and strain.

# **\*FREQUENCY\_DOMAIN\*FREQUENCY\_DOMAIN\_RANDOM\_VIBRATION**

---

<b>VARIABLE</b>	<b>DESCRIPTION</b>
SNTYPE	Stress type of S-N curve in fatigue analysis. EQ.0: von-mises stress EQ.1: maximum principal stress (not implemented) EQ.2: maximum shear stress (not implemented) EQ.-n: The n-th stress component.
SNLMT	Fatigue life for stress lower than the lowest stress on S-N curve. EQ.0: use the life at the last point on S-N curve EQ.1: extrapolation from the last two points on S-N curve EQ.2: infinity.
SID	Set ID for the panel exposed to acoustic environment, or the nodes subjected to nodal force excitation, or nodal acceleration excitation. For VAFLAG=1, base acceleration, leave this as blank
STYPE	Type of the set ID for the panel exposed to acoustic environment, or the nodes subjected to nodal force excitation: EQ. 0: Node EQ. 1: Node Set EQ. 2: Segment Set EQ. 3: Part EQ. 4: Part Set
DOF	Applicable degrees-of-freedom for nodal force excitation or base acceleration (DOF= 1, 2, and 3), or wave direction: EQ. 0: translational movement in direction given by vector VID. EQ. ±1: x-translational degree-of-freedom (positive or negative) EQ. ±2: y-translational degree-of-freedom (positive or negative) EQ. ±3: z-translational degree-of-freedom (positive or negative)
LDPSD	Load curve for PSD, SPL, or time history excitation.
LDVEL	Load curve for phase velocity.
LDFLW	Load curve for exponential decay for TBL in flow-wise direction
LDSPN	Load curve for exponential decay for TBL in span-wise direction
CID	Coordinate system ID for defining wave direction, see *DEFINE_COORDINATE_SYSTEM; or Vector ID for defining load direction for nodal force, or base excitation, see *DEFINE_VECTOR.
PID	Part ID, or Part Set ID, or Element (solid, shell, beam, thick shell) Set ID.

# **\*FREQUENCY\_DOMAIN\_RANDOM\_VIBRATION\*FREQUENCY\_DOMAIN**

---

<b>VARIABLE</b>	<b>DESCRIPTION</b>
LCID	S-N fatigue curve ID for the current Part or Part Set. GT. 0: S-N fatigue curve ID EQ. -1: S-N fatigue curve uses equation $N \cdot S^b = a$ EQ. -2: S-N fatigue curve uses equation $\log(S) = a - b \cdot \log(N)$
PTYPE	Type of PID. EQ. 0: Part (default) EQ. 1: Part Set EQ. 2: SET_SOLID EQ. 3: SET_BEAM EQ. 4: SET_SHELL EQ. 5: SET_TSHELL
LTYPE	Type of LCID. EQ. 0: Semi-log interpolation (default) EQ. 1: Log-Log interpolation
A	Material parameter a in S-N fatigue equation.
B	Material parameter b in S-N fatigue equation.
STHRES	Fatigue threshold.

## **Remarks:**

1. This command evaluates the structural random vibration response due to aero acoustic loads, base excitation or nodal force. This capability was originated from the Boeing's in-house code N-FEARA, which is a NIKE3D-based Finite Element tool for performing structural analysis with vibro-acoustic loads. The main developer of N-FEARA is Mostafa Rassaian from the Boeing company.
2. The Numbers of strip in U and V direction are used to group the elements into smaller number of integration domains to reduce computational time. This option is only available for VAFLAG=5, 6, and 7.
3. Restart option RESTRT=1 is used if mode analysis has been done previously. In this case, LS-DYNA skips modal analysis and reads in d3eigv family files generated previously. For RESTMD=1, always use MDMIN=1 and MDMAX = number of modes given by modal analysis (can be found from ASCII file eigout, or from d3eigv files by LSPREPOST).
4. DSFLAG defines the available output variables in binary plot file D3RMS and ASCII file ELOUT\_PSD. To get the stress results, DSFLAG should be 1 or 2, and MSTRES in

## **\*FREQUENCY\_DOMAIN\*FREQUENCY\_DOMAIN\_RANDOM\_VIBRATION**

---

\*CONTROL\_IMPLICIT\_EIGENVALUE should be 1; To get strain results, DSFLAG should be 2 and STRFLG in \*DATABASE\_EXTENT\_BINARY should be 1.

5. If METHOD=0, LS-DYNA uses modal superposition method for cases 4,5,6,7; For cases 1,2,3 and 8, LS-DYNA uses modal superposition method when preload condition is present and uses modal acceleration method when preload condition is not present.
6. In a set of consistent units, the unit for acceleration is defined as

$$1 \text{ (acceleration unit)} = \frac{1(\text{length unit})}{[1(\text{time unit})]^2}$$

Some users in industry prefer to use g (acceleration due to gravity) as the unit for acceleration. For example,

$$1 \text{ g} = 9.81 \frac{\text{m}}{\text{s}^2} \quad \text{or,} \quad 1 \text{ g} = 386.089 \frac{\text{inch}}{\text{s}^2}$$

If the input and output use g as the unit for acceleration, select UNIT=1, 2, or 3.

If UNIT=3, a multiplier (UMLT) for converting g to [length unit]/[time unit]<sup>2</sup> is needed and it is defined by

$$1\text{g}=\text{UMLT}\times[\text{length unit}]/[\text{time unit}]^2$$

For more information about the consistent units, see GS.21 (GETTING STARTED).

7. Number of points in the load curves LDSPL, LDVEL, LDFLW, and LDSPN are same. Number of points in the load curve LDDAMP can be different from those for LDSPL, LDVEL, LDFLW, and LDSPN.
8. Wave direction is determined DOF and VID.
9. RMS results are given for all nodes and elements.
10. CID represents a local U-V-W coordinate system for defining acoustic wave direction, only partially correlated waves (VAFLAG=5,6,7) need this local coordinate system. For nodal force, base excitation, plane wave or random pressure, CID represents a vector ID defining the load direction (DOF=±4).
11. Displacement, velocity and acceleration results are output into ASCII file NODOUT\_PSD. The nodes to be output to NODOUT\_PSD are specified by card \*DATABASE\_HISTORY\_NODE\_{OPTION}.
12. Stress results are output into ASCII file ELOUT\_PSD. The solid, beam, shell and thick shell elements to be output to ELOUT\_PSD are specified by the following cards: \*DATABASE\_HISTORY\_SOLID\_{OPTION},

## **\*FREQUENCY\_DOMAIN\_RANDOM\_VIBRATION\*FREQUENCY\_DOMAIN**

---

\*DATABASE\_HISTORY\_BEAM\_{OPTION},  
\*DATABASE\_HISTORY\_SHELL\_{OPTION},  
\*DATABASE\_HISTORY\_TSHELL\_{OPTION}.

13. When FATIGUE option is used, binary plot file d3ftg is written which includes the zero-crossing frequencies and accumulated damage ratio.
14. In some materials, the S–N curve flattens out eventually, so that below a certain threshold stress *STHRES* failure does not occur no matter how long the loads are cycled. *SNLIMT* can be set to 2 in this case; For other materials, such as aluminum, no threshold stress exists and *SNLIMT* should be set to 0 or 1 for added level of safety.
15. When FATIGUE option is used, same *PTYPE* (*PART* or *SET* of *ELEMENTS*) has to be used in case of multiple card 7.
16. S-N curves can be defined by *\*DEFINE\_CURVE*, or by the equations (*LCID*<0)

$$N \cdot S^b = a \text{ or } \log(S) = a - b \cdot \log(N)$$

Where *N* is the number of cycles for fatigue failure and *S* is the stress amplitude.

### **References:**

Mostafa Rassaian, Jung-Chuan Lee, N-FEARA – NIKE3D-based FE tool for structural analysis of vibro-acoustic loads, Boeing report, 9350N-GKY-02-036, December 5, 2003.

# **\*FREQUENCY\_DOMAIN\***FREQUENCY\_DOMAIN\_RESPONSE\_SPECTRUM

## **\*FREQUENCY\_DOMAIN\_RESPONSE\_SPECTRUM**

Purpose: perform response spectrum computation to obtain the peak response of a structure.

Card 1            1            2            3            4            5            6            7            8

Variable	MDMIN	MDMAX	FNMIN	FNMAX	RESTR	MCOMB	RELATV	
Type	I	I	F	F	I	I	I	
Default	1		0.0		0	0	0	

Card 2            1            2            3            4            5            6            7            8

Variable	DAMPF	LCDAMP	LDTYP	DMPMAS	DMPSTF			
Type	F	I	I	F	F			
Default	none	none	0	0.0	0.0			

### **Card 3 can be repeated if 2 or more input spectra exist (multiple-point response spectrum)**

Card 3	1	2	3	4	5	6	7	8
Variable	LCTYP	DOF	LC/TBID	SF	VID	LNID	LNTYP	INFLAG
Type	I	I	I	F	I	I	I	I
Default				1.0				0

#### VARIABLE

#### DESCRIPTION

MDMIN            The first mode in modal superposition method (optional).

MDMAX            The last mode in modal superposition method (optional).



## \*FREQUENCY\_DOMAIN\_RESPONSE\_SPECTRUM\*FREQUENCY\_DOMAIN

<u>VARIABLE</u>	<u>DESCRIPTION</u>
FNMIN	The minimum natural frequency in modal superposition method (optional).
FNMAX	The maximum natural frequency in modal superposition method (optional).
RESTRT	Restart option EQ.0: A new run including modal analysis, EQ.1: Restart with d3eigv family files created elsewhere.
MCOMB	Method for combination of modes: EQ.0: SRSS method, EQ.1: NRC Grouping method, EQ.2: Complete Quadratic Combination method (CQC), EQ.3: Double Sum method, EQ.4: NRL-SUM method.
RELATV	FLAG for displacement, velocity and acceleration results: EQ.0: Use relative values, EQ.1: Use absolute values.
DAMPF	Modal damping ratio, $\zeta$ .
LCDAMP	Load Curve ID for defining frequency dependent modal damping ratio $\zeta$ .
LDTYP	Type of load curve for LCDAMP EQ.0: Abscissa value defines frequency, EQ.1: Abscissa value defines mode number.
DMPMAS	Mass proportional damping constant $\alpha$ , in Rayleigh damping.
DMPSTF	Stiffness proportional damping constant $\beta$ , in Rayleigh damping.
LCTYP	Load curve type for defining the input spectrum. EQ.0: base velocity, EQ.1: base acceleration, EQ.2: base displacement, EQ.3: nodal force, EQ.4: pressure, EQ.10: base velocity time history, EQ.11: base acceleration time history, EQ.12: base displacement time history.

# **\*FREQUENCY\_DOMAIN\***FREQUENCY\_DOMAIN\_RESPONSE\_SPECTRUM

<u>VARIABLE</u>	<u>DESCRIPTION</u>
DOF	Applicable degrees-of-freedom for excitation input: EQ. 1: x-translational degree-of-freedom, EQ. 2: y-translational degree-of-freedom, EQ. 3: z-translational degree-of-freedom, EQ. 4: translational movement in direction given by vector VID.
LC/TBID	Load curve or table ID, see *DEFINE_TABLE, defining the response spectrum for frequencies. If the table definition is used a family of curves are defined for discrete critical damping ratios.
SF	Scale factor for the input load spectrum.
VID	Vector ID for DOF values of 4.
LNID	Node ID, or node set ID, or segment set ID where the excitation is applied. If the input load is given as base excitation spectrum, LNID=0
LNTYP	Set type for LNID: EQ.1: Node, see *NODE, EQ.2: Node set, see *SET_NODE, EQ.3: Segment set, see *SET_SEGMENT, EQ.4: Part, see *PART, EQ.5: Part set, see *SET_PART.
INFLAG	Frequency interpolation option EQ.0: Logarithmic interpolation, EQ.1: Semi-logarithmic interpolation. EQ.2: Linear interpolation.

## **Remarks:**

1. This command uses modal superposition method to evaluate the maximum response of a structure subjected to input response spectrum load, such as the acceleration spectrum load in earthquake engineering.
2. Modal analysis has to be performed preceding the response spectrum analysis. Thus the keywords \*CONTROL\_IMPLICIT\_GENERAL and \*CONTROL\_IMPLICIT\_EIGENVALUE are expected in the input file.
3. MDMIN, MDMAX, FNMIN and FNMAX should be set appropriately to cover all the natural modes inside the input spectrum.
4. To include stress results, modal stress computation has to be requested in \*CONTROL\_IMPLICIT\_EIGENVALUE (set MSTRES=1).

## \*FREQUENCY\_DOMAIN\_RESPONSE\_SPECTRUM\*FREQUENCY\_DOMAIN

5. For base excitation cases, user can choose relative values or absolute values for displacement, velocity and acceleration results output.
6. RESTRT=1 enables a fast restart run based on d3eigv family files generated in last run or elsewhere. LS-DYNA reads d3eigv family files to get the natural vibration frequencies and mode shapes.
7. For Double Sum method (MCOMB=3), earthquake duration time is given by ENDTIM in the keyword \*CONTROL\_TERMINATION.
8. Three interpolation options are available for frequency interpolation when reading response spectrum values

- a. When INFLAG=0 (default), logarithmic interpolation is used, e.g.

$$\frac{\log y - \log y_1}{\log x - \log x_1} = \frac{\log y_2 - \log y_1}{\log x_2 - \log x_1}$$

- b. When INFLAG=1, semi-logarithmic interpolation is used, e.g.

$$\frac{\log y - \log y_1}{x - x_1} = \frac{\log y_2 - \log y_1}{x_2 - x_1}$$

- c. When INFLAG=2, linear interpolation is used, e.g.  $\frac{y - y_1}{x - x_1} = \frac{y_2 - y_1}{x_2 - x_1}$

Linear interpolation is used for interpolation with respect to damping ratios.

# \*FREQUENCY\_DOMAIN

# \*FREQUENCY\_DOMAIN\_SSD

## \*FREQUENCY\_DOMAIN\_SSD

Purpose: Compute steady state dynamic response due to given spectrum of harmonic excitations.

Card 1            1            2            3            4            5            6            7            8

Variable	MDMIN	MDMAX	FNMIN	FNMAX	RESTMD	RESTDP		
Type	I	I	F	F	I	I		
Default	1		0.0		0	0		

Card 2            1            2            3            4            5            6            7            8

Variable	DAMPF	LCDAM	LCTYP	DMPMAS	DMPSTF			
Type	F	I	I	F	F			
Default	0.0	0	0	0.0	0.0			

Card 3            1            2            3            4            5            6            7            8

Variable						NOUT	NOTYP	NOVA
Type						I	I	I
Default						0	0	0

**Repeat Card 4 if multiple excitation loads are present.**

Card 4            1            2            3            4            5            6            7            8

Variable	NID	NTYP	DOF	VAD	LC1	LC2	LCFLAG	VID
Type	I	I	I	I	I	I	I	I
Default	none	0	none	none	none	none	0	0

**VARIABLE**

**DESCRIPTION**

MDMIN	The first mode in modal superposition method (optional).
MDMAX	The last mode in modal superposition method (optional).
FNMIN	The minimum natural frequency in modal superposition method (optional).
FNMAX	The minimum natural frequency in modal superposition method (optional).
RESTMD	Restart option: EQ.0: A new modal analysis is performed, EQ.1: Restart with d3eigv.
RESTDV	Restart option: EQ.0: A new run without dumpssd, EQ.1: Restart with dumpssd.
DAMPF	Modal damping coefficient, $\zeta$ .
LCDAM	Load Curve ID defining mode dependent modal damping coefficient $\zeta$ .
LCTYP	Type of load curve defining modal damping coefficient. EQ.0: Abscissa value defines frequency, EQ.1: Abscissa value defines mode number.
DMPMAS	Mass proportional damping constant $\alpha$ , in Rayleigh damping.
DMPSTF	Stiffness proportional damping constant $\beta$ , in Rayleigh damping..
NOUT	Part set/ Part/ Segment set/Node set ID for response output (optional).
NOTYP	Type of NOUT: EQ.0: part set ID (not implemented),

<b>VARIABLE</b>	<b>DESCRIPTION</b>
	EQ.1: part ID (not implemented), EQ.2: segment set ID, EQ.3: node set ID.
NOVA	Response output type. EQ.0: velocity, EQ.1: acceleration.
NID	Node / Node set/Segment set ID for excitation input.
NTYP	Type of NID. EQ.0: node ID, EQ.1: node set ID, EQ.2: segment set ID.
DOF	Applicable degrees-of-freedom for excitation input. EQ.1: x-translational degree-of-freedom, EQ.2: y-translational degree-of-freedom, EQ.3: z-translational degree-of-freedom, EQ.4: translational movement in direction given by vector VID.
VAD	Excitation input type: EQ.0: nodal force, EQ.1: pressure, EQ.2: base acceleration, EQ.3: enforced velocity (not implemented, see remarks 12), EQ.4: enforced acceleration (not implemented, see remarks 12), EQ.5: enforced displacement (not implemented, see remarks 12).
LC1	Load Curve ID defining real (in-phase) part (LCFLAG=0) or amplitude (LCFLAG=1) of load as a function of frequency.
LC2	Load Curve ID defining imaginary (out-phase) part (LCFLAG=0) or phase angle (LCFLAG=1) of load as a function of frequency.
LCFLAG	Load Curve definition flag. EQ.0: load curves are given as amplitude / phase angle, EQ.1: load curves are given as real / imaginary components.
VID	Vector ID for DOF=4 for excitation input, see *DEFINE_VECTOR.

**Remarks:**

- This command computes steady state dynamic response due to harmonic excitation spectrum by modal superposition method.

4. Natural frequencies and mode shapes are needed for running the modal superposition method. Thus, the keyword `*CONTROL_IMPLICIT_EIGENVALUE` has to be included in input.
5. `MDMIN/MDMAX` and `FNMIN/FNMAX` together determine which modes are used in modal superposition method. The first mode must have a mode number  $\geq$  `MDMIN`, and frequency  $\geq$  `FNMIN`; The last mode must have mode number  $\leq$  `MDMAX`, and frequency  $\leq$  `FNMAX`. When `MDMAX` or `FNMAX` is not given, the last mode in modal superposition method is the last mode available in `FILENM`.
6. Restart option `RESTMD=1` is used if mode analysis has been done previously. In this case, `LS-DYNA` skips modal analysis and reads in `d3eigv` family files generated previously. For `RESTMD=1`, always use `MDMIN=1` and `MDMAX` = number of modes given by modal analysis (can be found from ASCII file `eigout`, or from `d3eigv` files using `LS-PREPOST`).
7. Restart option `RESTDP=1` is used if user wants to add contribution of additional modes to previous SSD results. In this case, `LS-DYNA` reads in binary dump file “`dumpssd`” which contains previous SSD results and adds contribution from new modes. For `RESTDP=1`, the new modal analysis (`RESTMD=0`) or the `d3eigv` family files created elsewhere (`RESTMD=1`) should exclude the modes used in previous SSD computation. This can be done by setting `LFLAG` (and `RFLAG`, if necessary), and setting a nonzero `LFTEND` (and `RHTEND`) in `*CONTROL_IMPLICIT_EIGENVALUE`. The `RESTDP` option can also be used if the frequency range for modal analysis is divided into segments and modal analysis is performed for each frequency range separately.
8. Sometimes customers would like to add some acoustic field nodes and run BEM/FEM acoustic computation after SSD. The `RESTMD` and `RESTDP` options still work even if the number of nodes may get changed after previous modal analysis, provided that the IDs of the old nodes are not changed.
9. Damping can be prescribed in several ways:
  - To use a constant modal damping coefficient  $\zeta$  for all the modes, define `DAMPF` only. `LCDMP`, `LCTYP`, `DMPMAS` and `DMPSTF` are ignored.
  - To use mode dependent modal damping, define a load curve (`*DEFINE_CURVE`) and specify that if the abscissa value defines the frequency or mode number by `LCTYP`. `DMPMAS` and `DMPSTF` are ignored.
  - To use Rayleigh damping, define `DMPMAS` ( $\alpha$ ) and `DMPSTF` ( $\beta$ ) and keep `DAMPF` as 0.0, and keep `LCDMP`, `LCTYP` as 0. The damping matrix in Rayleigh damping is defined as  $C = \alpha M + \beta K$ , where, `C`, `M` and `K` are the damping, mass and stiffness matrices respectively.
10. `NOUT` and `NOTYP` are used to define the nodes where velocity or acceleration are requested to be written to a binary file “`bin_ssd`” or other filename defined by “`bem=filename`” (see keyword `*FREQUENCY_DOMAIN_ACOUSTIC_BEM`) in

command line. The velocity or acceleration data in this file can be used by BEM or FEM acoustic solver to perform a vibro-acoustic analysis.

11. When base acceleration (VAD=2), the parameters NID, NTYP are not used and can be blank. The base acceleration case is treated by applying inertia force to the structure.
12. For the cases with enforced motion excitation (e.g. nodal acceleration, velocity or displacement), the large mass method can be used to compute the SSD results. A very large mass  $m_L$ , which is usually  $10^5$ - $10^7$  ( $10^6$  is recommended for most cases) times of the mass of the entire structure, is attached to the nodes where the enforced motion excitation is applied (using the keyword \*ELEMENT\_MASS\_{OPTION}). A very large nodal force is also applied to the degree of freedom of excitation to produce the desired enforced motion. Then the problem is switched to the case with nodal force excitation (VAD=0).

The large nodal force  $p$  is computed as follows,

- For nodal acceleration,  $p = m_L \ddot{u}$
  - For nodal velocity,  $p = i \omega m_L \dot{u}$
  - For nodal displacement,  $p = -\omega^2 m_L u$
13. Displacement, velocity and acceleration results are output into ASCII file NODOUT\_SSD. The nodes to be output to NODOUT\_SSD are specified by card \*DATABASE\_HISTORY\_NODE\_{OPTION}
  14. Stress results are output into ASCII file ELOUT\_SSD. The solid, beam, shell and thick shell elements to be output to ELOUT\_SSD are specified by the following cards: \*DATABASE\_HISTORY\_SOLID\_{OPTION}, \*DATABASE\_HISTORY\_Beam\_{OPTION}, \*DATABASE\_HISTORY\_SHELL\_{OPTION}, \*DATABASE\_HISTORY\_TSHELL\_{OPTION}.
  15. The phase angle is given in range  $(-180^\circ, 180^\circ]$ .



# **\*HOURLASS**

Purpose: Define hourglass and bulk viscosity properties which are referenced via HGID in the \*PART command. Properties specified here, when invoked for a particular part, override those in \*CONTROL\_HOURLASS and \*CONTROL\_BULK\_VISCOSITY.

An additional option **\_TITLE** may be appended to **\*HOURLASS** keywords. If this option is used then an additional line is read for each section in 80a format which can be used to describe the section. At present LS-DYNA does not make use of the title. Inclusion of titles gives greater clarity to input decks.

Card 1            1            2            3            4            5            6            7            8

Variable	HGID	IHQ	QM	IBQ	Q1	Q2	QB/VDC	QW
Type	A8	I	F	I	F	F	F	F
Default	0		.10	0	1.5	0.06	QM/0.	QM
Remark		1,6	2,4,7	3	3	3	5	5

**VARIABLE**

**DESCRIPTION**

HGID            Hourglass ID. A unique number or label not exceeding 8 characters must be specified. This ID is referenced by HGID in the \*PART command.

# \*HOURLASS

---

<u>VARIABLE</u>	<u>DESCRIPTION</u>
IHQ	<p>Hourglass control type. For solid elements six options are available. For quadrilateral shell and membrane elements the hourglass control is based on the formulation of Belytschko and Tsay, i.e., options 1-3 are identical, and options 4-6 are identical:</p> <p>EQ.0: see remark 9, EQ.1: standard LS-DYNA viscous form, EQ.2: Flanagan-Belytschko viscous form, EQ.3: Flanagan-Belytschko viscous form with exact volume integration for solid elements, EQ.4: Flanagan-Belytschko stiffness form, EQ.5: Flanagan-Belytschko stiffness form with exact volume integration for solid elements. EQ.6: Belytschko-Bindeman [1993] assumed strain co-rotational stiffness form for 2D and 3D solid elements only. EQ.7: Linear total strain form of type 6 hourglass control. (See remark 6 below). EQ.8: Activates the full projection warping stiffness for accurate solutions with type 16 fully integrated shell element. A speed penalty of 25% is common for this option. EQ.9: Puso [2000] enhanced assumed strain stiffness form for 3D hexahedral elements. EQ.10: Cosserat Point Element (CPE) developed by Jabareen and Rubin [2008].</p> <p>A discussion of the viscous and stiffness hourglass control for shell elements follows at the end of this section.</p>
QM	<p>Hourglass coefficient. Values of QM that exceed .15 may cause instabilities. The recommended default applies to all options except for IHQ=6. The stiffness forms, however, can stiffen the response especially if deformations are large and therefore should be used with care. For the shell and membrane elements QM is taken as the membrane hourglass coefficient, the bending as QB, and warping as QW. These coefficients can be specified independently, but generally, QM=QB=QW, is adequate. For type 6 solid element hourglass control, see remark 4 below. For hourglass type 9, see Remark 8.</p>
IBQ	<p>Bulk viscosity type (See Remark 3 below.): EQ.1: standard LS-DYNA.</p>
Q1	<p>Quadratic bulk viscosity coefficient.</p>
Q2	<p>Linear bulk viscosity coefficient.</p>
QB	<p>Hourglass coefficient for shell bending. The default: QB=QM. (See Remark 4).</p>

---

<u>VARIABLE</u>	<u>DESCRIPTION</u>
VDC	Viscous damping coefficient for types 6 and 7 hourglass control.
QW	Hourglass coefficient for shell warping. The default: QB=QW.

## Remarks:

1. Viscous hourglass control is recommended for problems deforming with high velocities. Stiffness control is often preferable for lower velocities, especially if the number of time steps are large. For solid elements the exact volume integration provides some advantage for highly distorted elements.
2. For automotive crash the stiffness form of the hourglass control with a coefficient of 0.05 is preferred by many users.
3. Bulk viscosity is necessary to propagate shock waves in solid materials and therefore applies only to solid elements. Generally, the default values are okay except in problems where pressures are very high, larger values may be desirable. In low density foams, it may be necessary to reduce the viscosity values since the viscous stress can be significant. It is not advisable to reduce it by more than an order of magnitude.
4. Type 6 hourglass control is for 2D and 3D solid elements only. Based on elastic constants and an assumed strain field, it produces accurate coarse mesh bending results for elastic material when QM=1.0. For plasticity models with a yield stress tangent modulus that is much smaller than the elastic modulus, a smaller value of QM (0.001 to 0.1) may produce better results. For foam or rubber models, larger values (0.5 to 1.0) may work better. For any material, keep in mind that the stiffness is based on the elastic constants, so if the material softens, a QM value smaller than 1.0 may work better. For anisotropic materials, an average of the elastic constants is used. For fluids modeled with null material, type 6 hourglass control is viscous and is scaled to the viscosity coefficient of the material (see \*MAT\_NULL).
5. In part, the computational efficiency of the Belytschko-Lin-Tsay and the under integrated Hughes-Liu shell elements are derived from their use of one-point quadrature in the plane of the element. To suppress the hourglass deformation modes that accompany one-point quadrature, hourglass viscous or stiffness based stresses are added to the physical stresses at the local element level. The discussion of the hourglass control that follows pertains to all one point quadrilateral shell and membrane elements in LS-DYNA.

The hourglass shape vector  $\tau_I$  is defined as

$$\tau_I = h_I - (h_J \hat{x}_{aJ}) B_{aI}$$

where,  $\hat{x}_{aJ}$  are the element coordinates in the local system at the Ith element node,  $B_{aI}$  is the strain displacement matrix, and hourglass basis vector is:

## \*HOURLASS

---

$$\mathbf{h} = \begin{bmatrix} +1 \\ -1 \\ +1 \\ -1 \end{bmatrix}$$

is the basis vector that generates the deformation mode that is neglected by one-point quadrature. In the above equations and the remainder of this subsection, the Greek subscripts have a range of 2, e.g.,  $\hat{\mathbf{x}}_{\alpha 1} = (\hat{x}_{11}, \hat{x}_{21}) = (\hat{x}_1, \hat{y}_1)$ .

The hourglass shape vector then operates on the generalized displacements to produce the generalized hourglass strain rates

$$\dot{\mathbf{q}}_{\alpha}^{\text{M}} = \tau_1 \hat{\nu}_{\alpha 1}$$

$$\dot{\mathbf{q}}_{\alpha}^{\text{B}} = \tau_1 \hat{\theta}_{\alpha 1}$$

$$\dot{\mathbf{q}}_3^{\text{W}} = \tau_1 \hat{\nu}_{z1}$$

where the superscripts M, B, and W denote membrane, bending, and warping modes, respectively. The corresponding hourglass stress rates are then given by

$$\dot{\mathbf{Q}}_{\alpha}^{\text{M}} = \frac{\text{QM} \cdot \text{E t A}}{8} \mathbf{B}_{\beta 1} \mathbf{B}_{\beta 1} \dot{\mathbf{q}}_{\alpha}^{\text{M}}$$

$$\dot{\mathbf{Q}}_{\alpha}^{\text{B}} = \frac{\text{QB} \cdot \text{E t}^3 \text{A}}{192} \mathbf{B}_{\beta 1} \mathbf{B}_{\beta 1} \dot{\mathbf{q}}_{\alpha}^{\text{B}}$$

$$\dot{\mathbf{Q}}_3^{\text{W}} = \frac{\text{QW} \cdot \kappa \text{G t}^3 \text{A}}{12} \mathbf{B}_{\beta 1} \mathbf{B}_{\beta 1} \dot{\mathbf{q}}_3^{\text{W}}$$

where t is the shell thickness. The hourglass coefficients: QM, QB, and QW are generally assigned values between 0.05 and 0.10.

Finally, the hourglass stresses which are updated using the time step,  $\Delta t$ , from the stress rates in the usual way, i.e.,

$$\mathbf{Q}^{n+1} = \mathbf{Q}^n + \Delta t \dot{\mathbf{Q}}$$

and the hourglass resultant forces are then

$$\hat{\mathbf{f}}_{\alpha 1}^{\text{H}} = \tau_1 \mathbf{Q}_{\alpha}^{\text{M}}$$

$$\hat{\mathbf{m}}_{\alpha 1}^{\text{H}} = \tau_1 \mathbf{Q}_{\alpha}^{\text{B}}$$

$$\hat{f}_{31}^H = \tau_1 Q_3^W$$

where the superscript H emphasizes that these are internal force contributions from the hourglass deformations.

6. IHG=7 is a linear total strain formulation of the Belytschko-Bindeman [1993] stiffness form for 2D and 3D solid elements. This linear form was developed for visco-elastic material and guarantees that an element will spring back to its initial shape regardless of the severity of deformation.
7. The default value for QM is 0.1 unless superseded by a nonzero value of QH in \*CONTROL\_HOURGLASS. A nonzero value of QM supersedes QH.
8. Hourglass type 9 is available for hexahedral elements and is based on physical stabilization using an enhanced assumed strain method. In performance it is similar to the Belytschko-Bindeman hourglass formulation (type 6) but gives more accurate results for distorted meshes, e.g., for skewed elements. If QM=1.0, it produces accurate coarse bending results for elastic materials. The hourglass stiffness is by default based on elastic properties, hence the QM parameter should be reduced to about 0.1 for plastic materials in order not to stiffen the structure during plastic deformation. For materials 3, 18 and 24 there is the option to use a negative value of QM. With this option, the hourglass stiffness is based on the current material properties, i.e., the plastic tangent modulus, and scaled by  $|QM|$ .
9. The default value for IHQ, if not defined on \*CONTROL\_HOUGRGLASS is as follows:  
For shells: viscous type (1=2=3) for explicit; stiffness type (4=5) for implicit  
For solids: type 2 for explicit; type 6 for implicit.
10. For implicit analysis, hourglass forms 6, 7, 9, and 10 are available for solid elements, and the stiffness form (4=5) is available for shells.



# **\*INCLUDE**

Purpose: The keyword \*INCLUDE provides a means of reading independent input files containing model data. The file contents are placed directly at the location of the \*INCLUDE line.

**\*INCLUDE\_{OPTION}**

**\*INCLUDE\_COMPENSATION\_OPTION**

**\*INCLUDE\_TRIM**

**\*INCLUDE\_{OPTION}**

Available options include:

&lt;BLANK&gt;

**BINARY****NASTRAN****PATH****PATH\_RELATIVE****STAMPED\_PART\_{OPTION1}\_{OPTION2}\_{OPTION3}**OPTION1: **\_SET**OPTION2: **\_MATRIX**OPTION3: **\_INVERSE****STAMPED\_SET****TRANSFORM****TRANSFORM\_BINARY**

The **BINARY** and **TRANSFORM\_BINARY** options specify that the initial stress file, **DYNAIN**, is written in a binary format. See the keyword **\*INTERFACE\_SPRINGBACK**.

The **PATH** option defines a directory in which to look for the include files. The program always searches the local directory first. If an include file is not found and the filename has no path, the program will search for it in all the directories defined by **\*INCLUDE\_PATH**. Multiple paths can be defined with one **\*INCLUDE\_PATH** definition, i.e.,

**\*INCLUDE\_PATH**

Directory\_path1

Directory\_path2

Directory\_path3

Directory paths are read until the next “\*” card is encountered. A directory path can have up to 80 characters.

The **PATH\_RELATIVE** option is like the **PATH** option, except all directories are relative to the location of the input file. For example, if “i=/home/test/problems/input.k” is given on the command line, and the input contains

**\*INCLUDE\_PATH\_RELATIVE**

includes

../includes

then the two directories /home/test/problems/includes and /home/test/includes will be searched for include files.



The STAMPED\_PART option allows the plastic strain and thickness distribution of the stamping simulation to be mapped onto a part in the crash model.

1. When option 1, \_SET is used, the PID will be part set ID. All the parts included in this set will be considered in this mapping.
2. When option 2, \_MATRIX is used, translation matrix will be read directly and the orientation nodes will be ignored.
3. When option 3, \_INVERSE (must be used with \_MATRIX) is used, the matrix will be reversed first.

When STAMPED\_SET is used, the target is a part set ID. Between the stamped part and the crash part, note the following points:

1. The outer boundaries of the parts do not need to match since only the regions of the crash part which overlap the stamped part are initialized.
2. Arbitrary mesh patterns are assumed.
3. Element formulations can change.
4. Three nodes on each part are used to reorient the stamped part for the mapping of the strain and thickness distributions. After reorientation, the three nodes on each part should approximately coincide.
5. The number of in plane integrations points can change.
6. The number of through thickness integration points can change. Full interpolation is used.
7. The node and element ID's between the stamped part and the crash part do not need to be unique.

The TRANSFORM option allows for node, element, and set ID's to be offset and for coordinates and constitutive parameters to be transformed and scaled.

**The card is required.**

Card 1 1

Variable	FILENAME
Type	C

If the \*INCLUDE command is used without options, multiple filenames can be specified, i.e.,

```

*INCLUDE
Filename1
Filename2
Filename3

```

which are processed sequentially. Filenames are read until the next “\*” card is encountered.

# \*INCLUDE

\*INCLUDE\_{OPTION}

If the NASTRAN option is active then define the following input line.

## NASTRAN option

Card 2            1            2            3            4            5            6            7            8

Variable	BEAMDF	SHELLDF	SOLIDD F					
Type	I	I	I					
Default	2	21	18					

If the STAMPED\_PART option is active then define the following input.

## STAMPED\_PART option

Card 2            1            2            3            4            5            6            7            8

Variable	PID	THICK	PSTRN	STRAIN	STRESS	INCOUT		RMAX
Type	I	I	I	I	I	I		F
Default	none	0	0	0	0	0		10.0

If the \_MATRIX option is inactive define the follow card.

Card 3            1            2            3            4            5            6            7            8

Variable	N1S	N2S	N3S	N1C	N2C	N3C	TENSOR	THKSCL
Type	I	I	I	I	I	I	I	F
Default	0	0	0	0	0	0	0	1.0
Remarks	2	2	2	2	2	2	4	

If the **\_MATRIX** option is active define the follow three cards.

Card 3            1            2            3            4            5            6            7            8

Variable	R11	R12	R13	XP				
Type	F	F	F	F				
Default	0	0	0	0				
Remarks	2	2	2	2				

Card 4            1            2            3            4            5            6            7            8

Variable	R21	R22	R23	YP				
Type	F	F	F	F				
Default	0	0	0	0				
Remarks	2	2	2	2				

Card 5            1            2            3            4            5            6            7            8

Variable	R31	R32	R33	ZP				
Type	F	F	F	F				
Default	0	0	0	0				
Remarks	2	2	2	2				

# \*INCLUDE

\*INCLUDE\_{OPTION}

## Optional Cards

Card 4            1            2            3            4            5            6            7            8

Variable	ISYM	IAFTER	PERCELE					
Type	I	I	F					

Card 5            1            2            3            4            5            6            7            8

Variable	X01	Y01	Z01					
Type	F	F	F					

Card 6            1            2            3            4            5            6            7            8

Variable	X02	Y02	Z02	X03	Y03	Z03		
Type	F	F	F	F	F	F		

If the TRANSFORM option is active then define the following input.

### TRANSFORM option

Card 2            1            2            3            4            5            6            7            8

Variable	IDNOFF	IDEOFF	IDPOFF	IDMOFF	IDSOFF	IDFOFF	IDDOFF	
Type	I	I	I	I	I	I	I	

Card 3            1            2            3            4            5            6            7            8

Variable	IDROFF							
Type	I							

Card 4            1            2            3            4            5            6            7            8

Variable	FCTMAS	FCTTIM	FCTLEN	FCTTEM	INCOUT1			
Type	F	F	F	A	I			

Card 5            1            2            3            4            5            6            7            8

Variable	TRANID							
Type	I							
Default	0							

<u>VARIABLE</u>	<u>DESCRIPTION</u>
FILENAME	File name of file to be included in this keyword file, 80 characters maximum. If the STAMPED_PART option is active, this is the DYNAIN file containing the results from metal stamping.
BEAMDF	LS-DYNA beam element type. Defaults to type 2.
SHELLDF	LS-DYNA shell element type. Defaults to type 21.
SOLIDDF	LS-DYNA solid element type. Defaults to type 18.
PID	Part ID of crash part for remapping.

---

<b>VARIABLE</b>	<b>DESCRIPTION</b>
THICK	Thickness remap: EQ.0: map thickness EQ.1: do not map thickness EQ.2: average value inside a circle defined by RMAX
PSTRN	Plastic strain remap: EQ.0: map plastic strain EQ.1: do not plastic strain EQ.2: average value inside a circle defined by RMAX
STRAIN	Strain remap: EQ.0: map strains EQ.1: do not map strains
STRESS	Stress tensor remap: EQ.0: map stress tensor EQ.1: do not map stress tensor, only history EQ.-1: map stress tensor in an internal large format (binary files) EQ.-3: do not map stress tensor in an internal large format, only history (binary files)
THKSCL	Thickness scale factor.
INCOUT	EQ.1: to save the mapped data to a file called dyna.inc, which contains the mapped data for the part that is being mapped. This option is useful to do mapping using INCLUDE_STAMPED_PART and then save the mapped data for future use. When INCOUT is set to 2, the output file is in dynain format and the file name is dynain_xx (xx is the part or part set id); and when INCOUT is set to 3, the output file is in NASTRAN format, and the file name is: nastran_xx. EQ.2: to save the mapped data for the specified part (PID) to a file called dynain_PID. EQ.3: to save the mapped data for the specified part (PID) to a file called nastran_PID (in nastran format)
RMAX	Search radius
N1S	First of 3 nodes needed to reorient the stamped part.
N2S	Second of 3 nodes needed to reorient the stamped part.
N3S	Third of 3 nodes needed to reorient the stamped part.
N1C	First of 3 nodes needed to reorient the crash model part.

<b>VARIABLE</b>	<b>DESCRIPTION</b>
N2C	Second of 3 nodes needed to reorient the crash model part.
N3C	Third of 3 nodes needed to reorient the crash model part.
TENSOR	Tensor remap: EQ.0: map tensor data from history variables. (See Remark 4.) EQ.1: do not map tensor data from history variables
R11,R12,...R33	Components of the transformation matrix.
XP,YP,ZP	Translational distance.
X03,Y03,Z03	Third point in the symmetric plane
ISYM	Symmetric switch EQ.0: no symmetric mapping EQ.1: yz plane symmetric mapping EQ.2: zx plane symmetric mapping EQ.3: zx and yz planes symmetric mapping EQ.4: user defined symmetric plane mapping
IAFTER	Mirroring sequence switch EQ.0: generate a symmetric part before transformation EQ.1: generate a symmetric part after transformation
PERCELE	Percentage of elements that should be mapped to proceed (default=0); otherwise an error termination occurs.
X01, Y01, Z01	First point in the symmetric plane (required if ISYM.NE.0)
X02,Y02,Z02	Second point in the symmetric plane
X03,Y03,Z03	Third point in the symmetric plane
IDNOFF	Offset to node ID.
IDEOFF	Offset to element ID.
IDPOFF	Offset to part ID, nodal rigid body ID, constrained nodal set ID, Rigidwall ID, and *DATABASE_CROSS_SECTION.
IDMOFF	Offset to material ID and equation of state ID.
IDSOFF	Offset to set ID.
IDFOFF	Offset to function ID or table ID.

---

<u>VARIABLE</u>	<u>DESCRIPTION</u>
IDDOFF	Offset to any ID defined through DEFINE except the FUNCTION option.
IDROFF	Used for all offsets except for those listed above.
FCTMAS	Mass transformation factor. For example, FCTMAS=1000. When the original mass units are in tons and the new unit is kg.
FCTTIM	Time transformation factor. For example, FCTTIM=.001 when the original time units are in milliseconds and the new time unit is seconds.
FCTLEN	Length transformation factor.
FCTTEM	Temperature transformation factor consisting of a four character flag: FtoC (Fahrenheit to Centigrade), CtoF, FtoK, KtoF, KtoC, and CtoK.
INCOUT1	Set to 1 for the creation of a file, DYNA.INC, which contains the transformed data. The data in this file can be used in future include files and should be checked to ensure that all the data was transformed correctly.
TRANID	Transformation ID, if 0 no transformation will be applied. See the input DEFINE_TRANSFORMATION.

**Remarks:**

1. To make the input file easy to maintain, this keyword allows the input file to be split into subfiles. Each subfile can again be split into sub-subfiles and so on. This option is beneficial when the input data deck is very large. Consider the following example:

```
*TITLE
full car model
*INCLUDE
carfront.k
*INCLUDE
carback.k
*INCLUDE
occupantcompartment.k
*INCLUDE
dummy.k
*INCLUDE
bag.k
*CONTACT
...
*END
```

Note that the command \*END terminates the include file.



The carfront.k file can again be subdivided into rightrail.k, leftrail.k, battery.k, wheelhouse.k, shotgun.k, etc.. Each \*.k file can include nodes, elements, boundary conditions, initial conditions, and so on.

```
*INCLUDE
rightrail.k
*INCLUDE
leftrail.k
*INCLUDE
battery.k
*INCLUDE
wheelhouse.k
*INCLUDE
shotgun.k
...
...
*END
```

2. When defining \*INCLUDE\_STAMPED\_PART the target mesh must be read in before the include stamped part.

n1s, n2s, n3s, n1c, n2c, n3c are used for transforming the stamped part to the crashed part, such that it is in the same position as the crashed part. If the stamped part is in the same position as the crashed part then n1s, n2s, n3s, n4s, n1c, n2c, n3c can all be set to 0. Note: If these 6 nodes are input as 0, LS-DYNA will not transform the stamped part.

When symmetric mapping is used (ISYM is not zero), the three points should not be in one line.

If ISYM = 0, 1, 2, or 3, only the first point (X01, Y01, Z01) is needed

If ISYM = 4, all the three points are needed

3. All filenames and paths are limited to a total of 240 characters in length, and to a limit of 80 characters per line. To continue a filename or path over more than one line use '+' (note space before plus sign) on the end of the line.
4. Certain material models (notably Material 190) have tensor data stored within the history variables. Within material subroutines this data is typically stored in element local coordinate systems. In order to properly map this information between models it is necessary to have the tensor data present on the \*INITIAL\_STRESS\_SHELL card and have it stored in global coordinates. During mapping the data is then converted into the local coordinate system of the crash mesh. This data can be dumped into the dynain file that is created at termination time if the parameter FTENSOR is set to 0 on the \*INTERFACE\_SPRINGBACK\_DYNA3D card. Currently, the only material model that supports mapping of element history tensor data is Material 190.

# **\*INCLUDE**

# **\*INCLUDE\_COMPENSATION**

## **\*INCLUDE\_COMPENSATION\_{OPTION}**

Purpose: This group of keywords allow for the inclusion of stamping die geometry information for springback compensation. In addition, trim curves from the target geometry can be included for mapping onto the intermediate compensated tool geometry, which can be used for the next compensation iteration. Furthermore, compensation can be done for a localized tool region. These keywords must be used together with \*INTERFACE\_COMPENSATION\_NEW.

Options available include:

**BLANK\_BEFORE\_SPRINGBACK**

**BLANK\_AFTER\_SPRINGBACK**

**DESIRED\_BLANK\_SHAPE**

**COMPENSATED\_SHAPE**

**CURRENT\_TOOLS**

**TRIM\_CURVE**

**CURVE**

**ORIGINAL\_DYNAIN**

**SPRINGBACK\_INPUT**

**COMPENSATED\_SHAPE\_NEXT\_STEP**

**SYMMETRIC\_LINES**

For option **BLANK\_BEFORE\_SPRINGBACK**:

Card 1

1

Variable	FILENAME
Type	C
Default	./blank0.tmp

For option **BLANK\_AFTER\_SPRINGBACK:**

Card 1 1

Variable	FILENAME
Type	C
Default	./spbk.tmp

For option **DESIRED\_BLANK\_SHAPE:**

Card 1 1

Variable	FILENAME
Type	C
Default	./reference0.dat

For option **COMPENSATED\_SHAPE:**

Card 1 1

Variable	FILENAME
Type	C
Default	./reference1.dat

# \*INCLUDE

# \*INCLUDE\_COMPENSATION

For option **CURRENT\_TOOLS**:

Card 1 1

Variable	FILENAME
Type	C
Default	./rigid.tmp

For options **TRIM\_CURVE**, **CURVE**, **ORIGINAL\_DYNAIN**, **SPRINGBACK\_INPUT**,  
and, **COMPENSATED\_SHAPE\_NEXT\_STEP**:

Card 1 1 2 3 4 5 6 7 8

Variable	FILENAME
Type	C
Default	none

For option **SYMMETRIC\_LINES**:

Card 1 1 2 3 4 5 6 7 8

Variable	SYMID	SYMXY	X0	Y0				
Type	I	I	F	F				
Default	1	none	0.0	0.0				

---

<u>VARIABLE</u>	<u>DESCRIPTION</u>
FILENAME	<p>For options: BLANK_BEFORE_SPRINGBACK, BLANK_AFTER_SPRINGBACK, DESIRED_BLANK_SHAPE, COMPENSATED_SHAPE, CURRENT_TOOLS, COMPENSATED_SHAPE_NEXT_STEP, Input the name of the keyword files containing nodes and elements information, with adaptive constraints if exist. Currently all blanks must have the same numbers of nodes and elements.</p> <p>For option ORIGINAL_DYNAIN, input the dynain file name from LS-DYNA simulation (for example, trimmed panel from ITER0 baseline simulation) which contains model information, adaptive constraints, stress and strain tensor information. This keyword is to be used in conjunction with *INTERFACE_COMPENSATION_NEW_ACCELATOR.</p> <p>For option SPRINGBACK_INPUT, give the file name of springback simulation input deck for the baseline ITER0 simulation. This keyword is to be used in conjunction with *INTERFACE_COMPENSATION_NEW_ACCELATOR.</p> <p>For option TRIM_CURVE, input the name of the keyword file containing X, Y, Z coordinates as defined using keyword *DEFINE_CURVE_TRIM_3D.</p> <p>For option CURVE, input the name of the keyword file containing X, Y, Z coordinates of two curves defining the compensation zone, using keywords: *DEFINE_CURVE_COMPENSATION_BEGIN, and, *DEFINE_CURVE_COMPENSATION_END.</p>
SYMID	ID of the symmetric condition being defined.
SYMXY	Code defining symmetric boundary conditions: EQ.1: symmetric about Y-axis. EQ.2: symmetric about X-axis.
X0, Y0	Coordinates of a point on the symmetric plane.

**Remarks:**

1. This group of keywords is used in conjunction with \*INTERFACE\_COMPENSATION\_NEW, to compensate stamping tool shapes for springback with an iterative method. The

method approaches the final target design intent from two opposite directions from iteration to iteration. A typical successful compensation requires about 3~4 iterations. A complete keyword input example is shown below.

2. When the option `BLANK_BEFORE_SPRINGBACK` is used, the included file is the ‘dynain’ file just before springback prediction. For the first iteration, it might be the same as `reference0.dat`. It can also be the mesh after coarsening and before springback.

When the option `BLANK_AFTER_SPRINBACK` is used, the included file is the ‘dynain’ file just after springback prediction.

When the option `DESIRED_BLANK_SHAPE` is used, the included file is the ‘dynain’ file after trimming in the first iteration.

When the option `COMPENSATED_SHAPE` is used, the included file is the ‘dynain’ file. For the first iteration, it is the same as `reference0.dat`; and for the following iterations, this file is obtained from the ‘`disp.tmp`’ which is generated as an output file during the previous compensation iteration.

When the option `CURRENT_TOOLS` is used, the included file is the file containing the tool mesh. The tool mesh after each forming simulation. The draw bead nodes have to be included in this file so that they will be modified with the rigid tools. If the file is named `rigid0.tmp` the elements of the tools get refined along the outline of the part.

3. When the option `_TRIM_CURVE` is used, trim curves off the current tools are mapped onto the compensated tools in the next iteration, which can be used to trim the drawn panel in the next iteration. In addition, these mapped trim curves can be used for die development on the compensated tools and for laser trimming of stamped panels. LS-PrePost (page2/curve) can be used to convert IGES file of the trim curves to format (and vice versa) used in this keyword.

In the example shown below, the file name for this option is `trimcurves.k`. The format is in “.xyz” format, writable in LS-PrePost page 2/curve.

4. When the option `_CURVE` is used, it allows for die face compensation of a local region in stamping dies. This keyword is used in conjunction with two more keywords defining two enclosed curves that form the compensation zone in position coordinates X, Y, Z:

```
*DEFINE_CURVE_COMPENSATION_BEGIN,  
*DEFINE_CURVE_COMPENSATION_END.
```

Detailed usage of these two keywords is available in the related manual pages.

In a complete keyword example shown below, the file name for this option is `curves.k` containing these two keywords. The format is in “.xyz” format, writable in LS-PrePost page 2/curve. A detailed explanation of each keyword is given in manual pages related to `*INTERFACE_COMPENSATION_NEW`.

```

*KEYWORD
$---+---1---+---2---+---3---+---4---+---5---+---6---+---7---+---
*INTERFACE_COMPENSATION_NEW
$  METHOD         SL           SF           ELREF           PSID           UNDRCT           ANGLE  NLINEAR
          8          10.000          1.000           0             1             0             0.0         1

*INCLUDE_COMPENSATION_BLANK_BEFORE_SPRINGBACK
blank0.k
*INCLUDE_COMPENSATION_BLANK_AFTER_SPRINGBACK
spbk.k
*INCLUDE_COMPENSATION_DESIRED_BLANK_SHAPE
reference0.k
*INCLUDE_COMPENSATION_COMPENSATED_SHAPE
reference1.k
*INCLUDE_COMPENSATION_CURRENT_TOOLS
tools.k
*INCLUDE_COMPENSATION_TRIM_CURVE
trimcurves.k
$$$$$$$$$$$$$$$$$$$$$$$$$$$$$$$$$$$$$$$$$$$$$$$$$$$$$$$$$$$$$$$$
$ For compensation of a localize region only, add the following keyword:
*INCLUDE_COMPENSATION_CURVE
curves.k
$$$$$$$$$$$$$$$$$$$$$$$$$$$$$$$$$$$$$$$$$$$$$$$$$$$$$$$$$$$$$$$$
*SET_PART_LIST
$  PSID
    1
$  PID
    3
$---+---1---+---2---+---3---+---4---+---5---+---6---+---7---+---
*END

```

5. The option ORIGINAL\_DYNAIN and SPRINGBACK\_INPUT are used together with keyword \*INTERFACE\_COMPENSATION\_NEW\_ACCELERATOR, for a springback compensation with a faster convergence rate and a simplified user interface. For detailed usage, please refer to manual pages under \*INTERFACE\_COMPENSTION\_{OPTION}. Here a complete keyword input is provided:

```

*KEYWORD
*INTERFACE_COMPENSATION_NEW_ACCELERATOR
$  ISTEPs         TOLX         TOLY         TOLZ         OPTION
          3          0.20          0.20          0.2           1

*INCLUDE_COMPENSATION_ORIGINAL_DYNAIN
./case20trimmed.dynain
*INCLUDE_COMPENSATION_SPRINGBACK_INPUT
./spbk.dyn
*END

```

6. The option COMPENSATED\_SHAPE\_NEXT\_STEP enables compensation of tools for the next die process. It is used in conjunction with keyword \*INTERFACE\_COMPENSATION\_NEW\_MULTI\_STEPS, which is discussed in the corresponding manual pages. Here a complete input deck is given below:

```

*KEYWORD
*INTERFACE_COMPENSATION_NEW_MULTI_STEPS
$---+---1---+---2---+---3---+---4---+---5---+---6---+---7---+---8
$  METHOD         SL           SF           ELREF           PSID           UNDRCT           ANGLE  NLINEAR
          8          6.000          1.00           1             1             0             0         1

*INCLUDE_COMPENSATION_DESIRED_BLANK_SHAPE
reference0.tmp

```

```

*INCLUDE_COMPENSATION_COMPENSATED_SHAPE_NEXT_STEP
Referencel_flanging.tmp
*INCLUDE_COMPENSATION_CURRENT_TOOLS
rigid.tmp
*SET_PART_LIST
$   PSID
    1
$   PID
    2
*END

```

7. The option **SYMMTRIC\_LINES** applies to compensation Method 7 and 8, as discussed in **\*INTERFACE\_COMPENSATION\_NEW**. In a complete keyword input example below, part set ID 1 is being compensated with symmetric boundary condition about X-axis. The symmetric plane passes a point with coordinates of x=101.5, and y= 0.0.

```

*KEYWORD
$---+---1---+---2---+---3---+---4---+---5---+---6---+---7---+---8
*$INTERFACE_COMPENSATION_NEW
$ Method=8 changes the binder; Method=7 binder/P.O. no changes.
*INTERFACE_COMPENSATION_NEW
$   METHOD      SL      SF      ELREF      PSID      UNDRCT      ANGLE      NLINEAR
    7      10.000      1.000      2          1          1          0.0          1
*INCLUDE_COMPENSATION_BLANK_BEFORE_SPRINGBACK
./state1.k
*INCLUDE_COMPENSATION_BLANK_AFTER_SPRINGBACK
./state2.k
*INCLUDE_COMPENSATION_DESIRED_BLANK_SHAPE
./state1.k
*INCLUDE_COMPENSATION_COMPENSATED_SHAPE
./state1.k
*INCLUDE_COMPENSATION_CURRENT_TOOLS
./currenttools.k
*INCLUDE_COMPENSATION_SYMMETRIC_LINES
$   SYMID      SYMXY      X0      Y0
    1          2      101.5      0.0
$ SYMXY=2: symmetric about X-axis
*SET_PART_LIST
$   PSID
    1
$   PID
    1
*END

```

8. The option **TRIM\_CURVE** is available in LS-DYNA R5 Revision 60398 and later releases. The options **ORIGINAL\_DYNAIN**, and **SPRINGBACK\_INPUT** are available in R5 Revision 61264 and later releases. The option **COMPENSATED\_SHAPE\_NEXT\_STEP** is available in R5 Revision 61406 and later releases. The option **CURVE** is available in LS-DYNA R5 Revision 62038 and later releases. The option **SYMMETRIC\_LINES** is available in R5 Revision 63618 and later releases.





- The user creates one (or more) detailed models of their spotwelds, and includes these definitions into their model via the keyword `*INCLUDE_MULTISCALE_SPOTWELD`
- The user indicates which beam (or hex assembly) spotwelds should be coupled to these models via the keyword `*DEFINE_SPOTWELD_MULTISCALE`
- When MPP-DYNA is started, a special (MPI dependent) invocation is required in order to run in a “multiple program” mode. Effectively, two separate instances of MPP-DYNA are started together, one to run the full model and a separate instance to run the spotwelds.
- As the master process runs, each cycle it communicates to the slave process deformation information for the area surrounding each coupled spotweld. The slave process imposes this deformation on the detailed spotwelds, computes a failure flag for each, and communicates this back to the master process.
- The coupled spotwelds in the master process have their failure determined solely by these failure flags.

The file included via `*INCLUDE_MULTISCALE_SPOTWELD` should contain one generic instance of a detailed spotweld. For each coupled spotweld in the main model, a specific instance of this spotweld will be generated which is translated, rotated, and scaled to match the spotweld to which it is coupled. In this way, many spotwelds can be coupled with only a single `*INCLUDE_MULTISCALE_SPOTWELD`. The included file should contain everything required to define the spotweld, such as `*MAT` and `*PART` definitions, any required `*DEFINE_CURVE`s, etc., as well as `*NODE` and `*ELEMENT` definitions. In order for the translation and scaling to work properly, there are some assumptions made about the spotweld model:

- It should consist only of solid elements
- The Z axis of the fine model will be aligned with the coupled spotweld in the main model, with  $z=0$  and  $z=1$  at the two ends of the spotweld.
- The cross sectional area of the spotweld in the XY plane should be 1.
- That portion of the “top” and “bottom” of the spotweld that should be coupled to the main model need to be specified together in a single `*SET_NODE_LIST`
- One `*BOUNDARY_COUPLED` card needs to be given, referencing the `*SET_NODE_LIST` of the boundary nodes, a coupling type of 2, and a coupling program of 1.
- `*INCLUDE` cards inside the spotweld input are not supported.

Failure of the fine model is determined topologically, as follows. Any element of the spotweld having all four nodes of one of its faces belonging to the `*SET_NODE_LIST` of tied nodes is classified as a “tied” element. The “tied” elements are partitioned into two disjoint sets, the “top” and “bottom” of the spotweld. When there is no longer a complete path from any “top” to any “bottom” element (where a “path” passes through non-failed elements that share a common face), then the spotweld has failed. Note that this places some restrictions on the `*SET_NODE_LIST` and element geometry, namely that some “tied” elements exist, and the set of “tied” elements consists of exactly two disjoint subsets.

The details of launching a multi-program MPI program are installation dependent. But the idea behind actually running such a coupled model is that you want to run one set of MPI ranks as if you were running a normal MPP-DYNA job, such as:

```
mpirun -np 4 mppdyna i=input.k memory=200m p=pfile
```

and a second set with just the command line argument “slave” (no input file):

```
mpirun -np 4 mppdyna slave memory=100m p=pfile
```

The main instance knows to look for the slave (because of the presence of the `*INCLUDE_MULTISCALE_SPOTWELD` card), and will run the main model. The “slave” instance will run all the detailed spotweld models. Due to the nature of the coupling, the main model cannot progress when the detailed spotwelds are being processed, nor can the detailed spotwelds run while the main model is being computed. From a processor efficiency standpoint, it therefore makes sense to run as many slave processes as master processes, and run them on the same CPUs, so that each processing core has one slave and one master process running on it. But you don’t have to – the processes are independent and you can have any number of either.

**\*INCLUDE\_TRIM**

Purpose: This keyword is developed to reduce memory requirements and CPU time during trimming in sheet metal forming.

Card 1            1            2            3            4            5            6            7            8

Variable	FILENAME						
Type	A						

<u>VARIABLE</u>	<u>DESCRIPTION</u>
FILENAME	File name of the part to be trimmed.

**Remarks:**

1. When option \_TRIM is used, the name of the file should be included in a usual LS-DYNA input file for trimming. For example, a drawn panel from previous simulation can be included in a current trim input file as follows,

```
*INCLUDE_TRIM
Drawnpanel.dynain
```

No optional cards are necessary.

2. Referring to the table below (parts courtesy of Ford Motor Company), the new TRIM option reduces memory requirement for trimming by more than 50%. Levels of CPU time reductions vary, in some cases more than 50%.
3. This feature is available in LS-DYNA R5 Revision 62207 or later releases, where the output of strain tensors for the shells is included. Prior Revisions do not include strain tensors for the shells.

	Roof	Hood Inr	B-Plr	Fender	BSA Otr	Door Otr	Wheel House (2 in 1)	Boxside Otr
#Element	410810	1021171	351007	189936	380988	315556	261702	1908369
CPU (old/new)	7m26s/ 4m	10m20s/ 9m18s	3m11s/ 2m56s	2m6s/ 1m22s	5m45s/ 4m54s	4m27s/ 3m35s	2m52s/ 2m30s	27m31s/ 13m59s
Memory (MW) (old/new)	282/ 112	616/ 383	221/ 117	119/ 50	233/ 130	217/ 114	157/ 75	1150/ 539



# **\*INITIAL**

The keyword **\*INITIAL** provides a way of initializing velocities and detonation points. The keyword control cards in this section are defined in alphabetical order:

**\*INITIAL\_AIRBAG\_PARTICLE\_POSITION**

**\*INITIAL\_ALE\_MAPPING**

**\*INITIAL\_AXIAL\_FORCE\_BEAM**

**\*INITIAL\_DETONATION**

**\*INITIAL\_FOAM\_REFERENCE\_GEOMETRY**

**\*INITIAL\_GAS\_MIXTURE**

**\*INITIAL\_INTERNAL\_DOF\_SOLID\_{OPTION}**

**\*INITIAL\_MOMENTUM**

**\*INITIAL\_PWP\_DEPTH**

**\*INITIAL\_STRAIN\_SHELL\_{OPTION}**

**\*INITIAL\_STRAIN\_SOLID\_{OPTION}**

**\*INITIAL\_STRESS\_BEAM**

**\*INITIAL\_STRESS\_DEPTH**

**\*INITIAL\_STRESS\_SECTION**

**\*INITIAL\_STRESS\_SHELL\_{OPTION}**

**\*INITIAL\_STRESS\_SOLID**

**\*INITIAL\_STRESS\_TSHELL**

**\*INITIAL\_TEMPERATURE\_{OPTION}**

**\*INITIAL\_VEHICLE\_KINEMATICS**

Two mutually exclusive methods are available for initial velocity generation:

**\*INITIAL\_VELOCITY**

## **\*INITIAL**

---

**\*INITIAL\_VELOCITY\_NODE**

**\*INITIAL\_VELOCITY\_RIGID\_BODY**

**\*INITIAL\_VELOCITY\_GENERATION**

and:

**\*INITIAL\_VELOCITY\_GENERATION\_START\_TIME**

The latter is convenient for specifying initial rotational velocities about arbitrary axes. These methods for velocity generation must not be mixed in a single input deck.

**\*INITIAL\_VOID\_{OPTION}**

**\*INITIAL\_VOLUME\_FRACTION**

**\*INITIAL\_VOLUME\_FRACTION\_GEOMETRY**



**\*INITIAL\_AIRBAG\_PARTICLE\_POSITION**

Purpose: This card initializes the position of CPM initial air particle to the location specified. If the number of coordinates given is less than the number of initial air particles, the coordinates will be reused and the particle may share the same location at the beginning of the simulation.

Card 1            1            2            3            4            5            6            7            8

Variable	Bag_ID								
Type	I								
Default	none								

Card Format (8x,3e16.0)

Card 2...n       1            2            3            4            5            6            7            8

Variable		X	Y	Z					
Type	8x	F	F	F					
Default									

<u>VARIABLE</u>	<u>DESCRIPTION</u>
Bag_ID	Airbag ID defined in *AIRBAG_PARTICLE_ID card
X	X coordinate
Y	Y coordinate
Z	Z coordinate

**\*INITIAL\_ALE\_MAPPING**

Purpose: This card initializes the current ALE run with data from the last cycle of a previous ALE run. Data are read from a mapping file called by the prompt “map=” on the command line (see remarks 4 and 5). To map data histories (not just the last cycle) to a region of selected elements (not all the ALE domain) see \*BOUNDARY\_ALE\_MAPPING.

There are different mappings:

- 1D to 2D
- 1D to 3D
- 2D to 2D
- 2D to 3D
- 3D to 3D

Card 1            1            2            3            4            5            6            7            8

Variable	PID	TYP	AMMSID					
Type	I	I	I					
Default	none	none	none					

Card 2            1            2            3            4            5            6            7            8

Variable	XO	YO	ZO	VECID	ANGLE			
Type	F	F	F	I	F			
Default	0.0	0.0	0.0	none	none			

<u>VARIABLE</u>	<u>DESCRIPTION</u>
PID	Part ID or part set ID.
TYP	Type of “PID” (see remark 1): EQ.0: part set ID (PSID). EQ.1: part ID (PID).
AMMSID	Set ID of ALE multi-material groups defined in *SET_MULTI-MATERIAL_GROUP. See remark 1.

---

<u>VARIABLE</u>	<u>DESCRIPTION</u>
XO	Origin position in global X-direction. See remarks 2 and 7.
YO	Origin position in global Y-direction. See remarks 2 and 7.
ZO	Origin position in global Z-direction. See remarks 2 and 7.
VECID	ID of the symmetric axis defined by *DEFINE_VECTOR. See remarks 3 and 7.
ANGLE	Angle of rotation around an axis defined by *DEFINE_VECTOR for the 3D to 3D mapping. See remark 6.

**Remarks:**

1. The routines of this card need to know which mesh will be initialized with the mapping data and more specifically which multi-material groups. The first 2 parameters (PID and TYP) defines the mesh and the third one (AMMSID) calls the \*SET\_MULTI-MATERIAL\_GROUP\_LIST card. This card will define a list of material groups in the current run. The rank in this list should match the rank of the multi-material groups from the previous run (as a reminder the ranks of multi-material groups are defined by \*ALE\_MULTI-MATERIAL\_GROUP). Let's take an example. For instance if the previous model has 3 groups, the current one has 5 groups and the following mapping is wanted:

- The 1<sup>st</sup> group from the previous run is mapped on the 3<sup>rd</sup> one in the current run,
- The 2<sup>nd</sup> group from the previous run is mapped on the 5<sup>th</sup> one in the current run,
- The 3<sup>rd</sup> group from the previous run is mapped on the 4<sup>th</sup> one in the current run,

The \*SET\_MULTI-MATERIAL\_GROUP\_LIST card should be set as follows:

```
*SET_MULTI-MATERIAL_GROUP_LIST  
300  
3,5,4
```

2. The data can be mapped in different parts of the mesh by defining the origin of the coordinate system (XO,YO,ZO).
3. For a mapping between a 2D axisymmetric model and a 3D run the symmetric axis orientation in the 3D model needs to be defined. For a mapping from 2D to 2D the vector is not used but \*DEFINE\_VECTOR is still read. For a 3D to 3D mapping the vector is used if the parameter ANGLE is defined (see Remark 6).
4. To create the mapping file: only the prompt "map=" is necessary. If the keyword INITIAL\_ALE\_MAPPING is not in the input deck and the prompt "map=" is in the command line, the ALE data of the last cycle are written in the mapping file.

5. To make several successive mapping: the prompt “map1=” is necessary. If the keyword INITIAL\_ALE\_MAPPING is in the input deck and the prompt “map=” is in the command line, the ALE data are read from the mapping file defined by “map=” to initialize the run. Data of the last cycle are written in the mapping file defined by “map1=”.
6. For a mapping from a previous 3D run to a current 3D model, the parameter ANGLE allows to rotate the previous 3D domain around an axis identified by VECID and defined by \*DEFINE\_VECTOR.
7. The definitions of X0, Y0, Z0 and VECID change in the case of the following mappings:
  - plain strain 2D (elform=13 in \*SECTION\_ALE2D) to plain strain 2D
  - plain strain 2D to 3D

VECID still defines the y-axis in the 2D domain. The 3 first parameters in \*DEFINE\_VECTOR defines the location of the origin. The 3 last parameters defines a position along the y-axis. X0, Y0, Z0 are the coordinate of a point on the 2D section.

**\*INITIAL\_AXIAL\_FORCE\_BEAM**

Purpose: Initialize the axial force resultants in beam elements that are used to model bolts. This option works with \*MAT\_SPOTWELD with beam type 9, a Hughes-Liu type beam. The beam elements listed in this section will be active in contact unlike the spot weld beam elements, which are automatically excluded in the automatic contact treatments.

Card 1            1            2            3            4            5            6            7            8

Variable	BSID	LCID	SCALE					
Type	I	I	F					
Default	none	none	1.0					

<u>VARIABLE</u>	<u>DESCRIPTION</u>
BSID	Beam set ID.
LCID	Load curve ID defining preload force versus time. When the load curve ends or goes to zero, the initialization is assumed to be completed. See remark 2 below.
SCALE	Scale factor on load curve.

**Remarks:**

1. To achieve convergence during explicit dynamic relaxation, the application of the damping options is very important. If contact is active, contact damping is recommended with a value between 10-20 percent. Additional damping, via the option DAMPING\_PART\_STIFFNESS also speeds convergence where a coefficient of 0.10 is effective. If damping is not used, convergence may not be possible.
2. When defining the load curve, LCID, a ramp starting at the origin should be used to increase the force to the desired value. The time duration of the ramp should produce a quasi static response. When the end of the load curve is reached, or when the value of the load decreases from its maximum value, the initialization stops. If the load curve begins at the desired force value, i.e., no ramp, convergence will take much longer, since the impulsive like load created by the initial force can excite nearly every frequency in the structural system where force is initialized.

**\*INITIAL\_DETONATION**

Purpose: Define points to initiate the location of high explosive detonations in part ID's which use the material (type 8) \*MAT\_HIGH\_EXPLOSIVE\_BURN. Also see \*CONTROL\_EXPLOSIVE\_SHADOW.

Card 1            1            2            3            4            5            6            7            8

Variable	PID	X	Y	Z	LT			
Type	I	F	F	F	F			
Default	all HE	0.	0.	0.	0,			

**Optional card required if and only if PID=-1.**

Card 2            1            2            3            4            5            6            7            8

Variable	PEAK	DECAY	XS	YS	ZS	NID		
Type	F	F	F	F	F	I		
Remark	1	1						

**VARIABLE****DESCRIPTION**

PID	Part ID of high explosive material to be lit, see *PART. However, two other options are available: EQ.-1: an acoustic boundary, also, *BOUNDARY_USA_SURFACE, EQ. 0: all high explosive materials are considered.
X	x-coordinate of detonation point, see Figure 21.1.
Y	y-coordinate of detonation point.
Z	z-coordinate of detonation point.
LT	Lighting time for detonation point. This time is ignored for an acoustic boundary.

<u>VARIABLE</u>	<u>DESCRIPTION</u>
PEAK	Peak pressure, $p_o$ , of incident pressure pulse, see remark below.
DECAY	Decay constant, $\tau$
XS	x-coordinate of standoff point, see Figure 21.1.
YS	y-coordinate of standoff point
ZS	z-coordinate of standoff point
NID	Reference node ID near structure

**Remarks:**

For solid elements (not acoustic) two options are available. If the control card option, \*CONTROL\_EXPLOSIVE\_SHADOW, is not used the lighting time for an explosive element is computed using the distance from the center of the element to the nearest detonation point,  $L_d$ ; the detonation velocity,  $D$ ; and the lighting time for the detonator,  $t_d$ :

$$t_L = t_d + \frac{L_d}{D}$$

The detonation velocity for this default option is taken from the element whose lighting time is computed and does not account for the possibilities that the detonation wave may travel through other explosives with different detonation velocities or that the line of sight may pass outside of the explosive material.

If the control card option, \*CONTROL\_EXPLOSIVE\_SHADOW, is defined, the lighting time is based on the shortest distance through the explosive material. If inert obstacles exist within the explosive material, the lighting time will account for the extra time required for the detonation wave to travel around the obstacles. The lighting times also automatically accounts for variations in the detonation velocity if different explosives are used. No additional input is required for this option but care must be taken when setting up the input. This option works for two and three-dimensional solid elements. It is recommended that for best results:

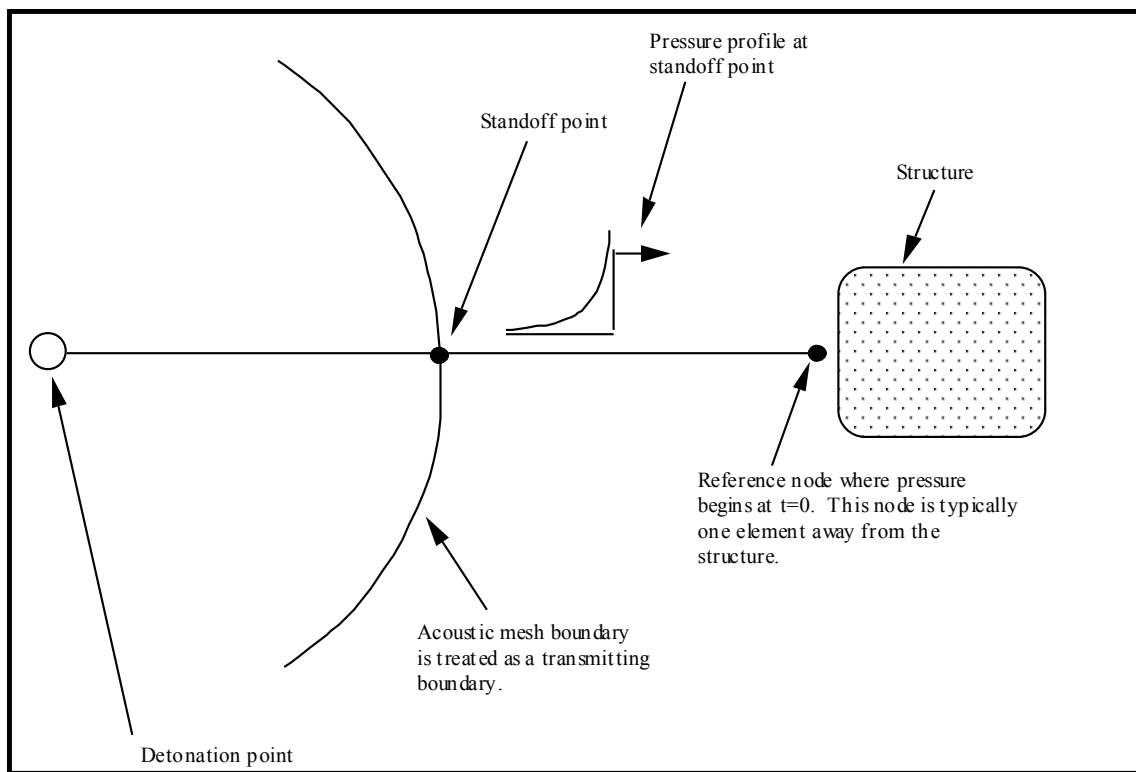
1. Keep the explosive mesh as uniform as possible with elements of roughly the same dimensions.
2. Inert obstacle such as wave shapers within the explosive must be somewhat larger than the characteristic element dimension for the automatic tracking to function properly. Generally, a factor of two should suffice. The characteristic element dimension is found by checking all explosive elements for the largest diagonal.

3. The detonation points should be either within or on the boundary of the explosive. Offset points may fail to initiate the explosive.
4. Check the computed lighting times in the post processor LS-PREPOST. The lighting times may be displayed at time=0., state 1, by plotting component 7 (a component normally reserved for plastic strain) for the explosive material. The lighting times are stored as negative numbers. The negative lighting time is replaced by the burn fraction when the element ignites.

Line detonations may be approximated by using a sufficient number of detonation points to define the line. Too many detonation points may result in significant initialization cost.

The pressure versus time curve for the acoustic option is defined by:

$$p(t) = p_0 e^{-\frac{t}{\tau}}$$



**Figure 21.1** Initialization of the initial pressures due to an explosive disturbance is performed in the acoustic media. LS-DYNA automatically determines the acoustic mesh boundary and applies the pressure time history to the boundary. This option is only applicable to the acoustic element formulation, see \*SECTION\_SOLID.



**\*INITIAL\_FIELD\_SOLID**

Purpose: This keyword is a simplified version of \*INITIAL\_STRESS\_SOLID which can be used with hyperelastic materials. The keyword is used for history variable input. Data is usually in the form of the eigenvalues of diffusion tensor data. These are expressed in the global coordinate system. The input deck takes the following parameters:

NOTE: As of LS-DYNA R5. This keyword is **only** applicable together with \*MAT\_TISSUE\_DISPERSED (use the more general \*INITIAL\_STRESS\_SOLID for other materials).

Card 1            1            2            3            4            5            6            7            8

Variable	EID	NINT	NHISV					
Type	I	I	I					
Default	none	none	0					

Card 2            1            2            3            4            5            6            7            8

Variable	FLD1	FLD2	FLD3	FLD4	FLD5	FLD6	FLD7	FLD8
Type	F	F	F	F	F	F	F	F
Default								

<u>VARIABLE</u>	<u>DESCRIPTION</u>
EID	Element ID
NINT	Number of integration points (should correspond to the solid element formulation).
NHISV	Number of field variables. If NHISV exceeds the number of integration point field variables required by the constitutive model, only the number required is output; therefore, if in doubt, set NHISV to a large number.
FLDn	Data for the nth field (history) variable. NOTE that *MAT_TISSUE_DISPERSED only use FLD1 to FLD3 since NHISV=3.

**Remarks:**

Add as many cards as necessary. The keyword input ends when next keyword appears (next \*).  
For example for two elements it can look as:

```
*INITIAL_FIELD_SOLID
$EID      NINT      NHISV
   1         1         3
$FLD1     FLD2     FLD3
  0.1       0.8       0.1
$EID      NINT      NHISV
   2         1         3
$FLD1     FLD2     FLD3
  0.3       0.2       0.5
```

**\*INITIAL\_FOAM\_REFERENCE\_GEOMETRY**

Purpose: The reference configuration allows stresses to be initialized in the following hyperelastic material models: 2, 5, 7, 21, 23, 27, 31, 38, 57, 73, 77, 83, 132, 179, 181, 183, and 189. Supported solid elements are the constant stress hexahedron (#1), the fully integrated S/R hexahedron (#2), the tetrahedron (#10), and the pentahedron (#15).

To use this option, the geometry of the foam material is defined in a deformed configuration. The stresses in the low density foam then depend only on the deformation gradient matrix  $F_{ij}$  :

$$F_{ij} = \frac{\partial x_i}{\partial X_j}$$

where  $x_i$  is the deformed configuration and  $X_j$  is the undeformed configuration. By using this option, dynamic relaxation can be avoided once a deformed configuration is obtained usually on the first run of a particular problem.

Card 1,...            1            2            3            4            5            6            7            8            9            10

Variable	NID	X	Y	Z						
Type	I	F	F	F						
Default	none	0.	0.	0.						
Remarks										

**VARIABLE****DESCRIPTION**

NID	Node number
X	x coordinate in reference configuration
Y	y coordinate in reference configuration
Z	z coordinate in reference configuration

# \*INITIAL

# \*INITIAL\_GAS\_MIXTURE

## \*INITIAL\_GAS\_MIXTURE

Purpose: This command is used to specify (a) which ALE multi-material groups may be present inside an ALE mesh set at time zero, and (b) the corresponding reference gas temperature and density which define the initial thermodynamic state of the gases. The order of the species in the gas mixture corresponds to the order of different gas species defined in the associated \*MAT\_GAS\_MIXTURE card. This card must be used together with a \*MAT\_GAS\_MIXTURE (or equivalently, a \*MAT\_ALE\_GAS\_MIXTURE) card.

Card 1            1            2            3            4            5            6            7            8

Variable	SID	STYPE	MMGID	TEMP				
Type	I	I	I	F				
Default	none	0	none	none				

Card 2            1            2            3            4            5            6            7            8

Variable	RO1	RO2	RO3	RO4	RO5	RO6	RO7	RO8
Type	F	F	F	F	F	F	F	F
Default	0.0	0.0	0.0	0.0	0.0	0.0	0.0	0.0

### VARIABLE

### DESCRIPTION

SID                      Set ID for initialization. This SID defines the ALE mesh within which certain ALE multi-material group(s) may be present at t=0.

STYPE                   Set type for the SID above:  
EQ.0: SID is a part set ID  
EQ.1: SID is a part ID

MMGID                   ALE Multi-material group ID of the material that may be present at t=0 in the ALE mesh set defined by SID.

VARIABLE	DESCRIPTION
TEMP	Initial static temperature of the gas species occupying the ALE mesh. Note that all species in the mixture are assumed to be in thermal equilibrium (having the same T).
RO1-RO8	Initial densities of the ALE material(s) which may be occupying some region (or all) of the aforementioned ALE mesh, for up to eight different gas species. The order of the density input corresponds to the order of the materials defined in associated *MAT_GAS_MIXTURE card.

**Remarks:**

1. Please see the example under the \*MAT\_GAS\_MIXTURE card definition for an application of the \*INITIAL\_GAS\_MIXTURE card.
2. The temperature is assumed to be the initial temperature which together with the gas density, will define the initial pressure of the gas species via the perfect gas law ( $P|_{t=0} = \rho|_{t=0} (C_p - C_v) T|_{t=0}$ ). The user should manually check the initial pressure for consistency.
3. Given an ALE mesh, this mesh may initially be occupied by one or more ALE multi-material groups (AMMG). For example, a background ALE mesh (H1) containing AMMG 1 may be partially filled with AMMG 2 via the volume filling command \*INITIAL\_VOLUME\_FRACTION\_GEOMETRY. Then there are 2 AMMGs to be initialized for this mesh H1. The commands look like the following.

```

$-----
$ One card is defined for each AMMG that will occupy some elements of a mesh set
*INITIAL_GAS_MIXTURE
$   SID      STYPE      MMGID      T0
      1        1          1          298.15
$   RHO1      RHO2      RHO3      RHO4      RHO5      RHO6      RHO7      RHO8
      1.0E-9
*INITIAL_GAS_MIXTURE
$   SID      STYPE      MMGID      T0
      1        1          2          298.15
$   RHO1      RHO2      RHO3      RHO4      RHO5      RHO6      RHO7      RHO8
      1.2E-9
$-----

```

# \*ALE

# \*INITIAL\_HYDROSTATIC\_ALE

## \*INITIAL\_HYDROSTATIC\_ALE

Purpose: When an ALE model contains one or more regular (not reservoir-type) ALE parts (ELFORM=11 and AET=0), this command may be used to initialize the hydrostatic pressure field in the regular ALE domain due to gravity. The \*LOAD\_BODY\_(OPTION) keyword must be defined.

Card 1            1            2            3            4            5            6            7            8

Variable	ALESID	STYPE	VECID	GRAV	PBASE			
Type	I	I	I	I	I			
Default	0	0	0	0	0			

**Card 2:** Each line defines one AMMG layer below its reference NID. Repeat card 2 as many times as the number of AMMG layers present in the model.

Card 2            1            2            3            4            5            6            7            8

Variable	NID	MMGBLO						
Type	F	F						
Default	0.0	1.E+10						

### VARIABLE

### DESCRIPTION

ALESID	ALESID is a set ID defining the ALE domain/mesh whose hydrostatic pressure field due to gravity is being initialized by this keyword. See remark 2.
STYPE	ALESID set type EQ.0: Part set ID (PSID), EQ.1: Part ID (PID).
VECID	Vector ID of a vector defining the direction of gravity.
GRAV	Magnitude of the Gravitational acceleration (example, in metric ~ 9.80665 m/s <sup>2</sup> )

VARIABLE	DESCRIPTION
PBASE	Nominal or reference pressure at the top surface of all fluid layers. By convention, the gravity direction points from the top layer to the bottom layer. Each fluid layer must be represented by an ALE multi-material group ID (AMMGID or MMG). . Please see remark 1.
NID	Node ID defining the top of an ALE fluid (AMMG) layer.
MMGBLO	AMMG ID of the fluid layer immediately below this NID. Each node is defined in association with one AMMG layer below it.

**Remarks:**

1. Assuming a model with multi-layers of ALE fluids, given the pressure at the top surface of the top fluid layer (PBASE), the hydrostatic pressure is computed as following

$$P = P_{base} + \sum_{i=1}^{N_{AMMG-layers}} \rho_i g h_i$$

2. This keyword applies only to the regular ALE parts with ELFORM=11 and AET=0 under \*SECTION\_SOLID card (not reservoir-type). This keyword cannot be used to initialize reservoir-type ALE part (AET=4). Also, no ramping function is available, so the loading is done in one step at t=0. For initializing reservoir-type ALE domain, please review the \*ALE\_ABIENT\_HYDROSTATIC keyword.

**Example:**

Model Summary: Consider a model consisting of 2 ALE parts, air on top of water.

H1 = AMMG1 = Air part above.

H2 = AMMG2 = Water part below.

```

$...|...1...|...2...|...3...|...4...|...5...|...6...|...7...|...8
$ (non-ambient) ALE materials (fluids) listed from top to bottom:
$
$ NID AT TOP OF A LAYER SURFACE          ALE MATERIAL LAYER BELOW THIS NODE
$ TOP OF 1st LAYER -----> 1722          -----
$                                         Air above   = PID 1 = H1 = AMMG1 (AET=0)
$ TOP OF 2nd LAYER -----> 1712          -----
$                                         Water below = PID 2 = H2 = AMMG2 (AET=0)
$ BOTTOM ----->                          -----
$...|...1...|...2...|...3...|...4...|...5...|...6...|...7...|...8
*INITIAL_HYDROSTATIC_ALE
$  ALESID      STYPE      VECID      GRAV      PBASE
$      12         0         11      9.80665   101325.0
$      NID      MMGBLO
$      1722         1
$      1712         2
*SET_PART_LIST
$      12
$      1         2
*ALE_MULTI-MATERIAL_GROUP
$      1         1
$      2         1
*DEFINE_VECTOR
$      VID      XT      YT      ZT      XH      YH      ZH      CID
$      11      0.0    1.0    0.0    0.0    0.0    0.0
$...|...1...|...2...|...3...|...4...|...5...|...6...|...7...|...8

```



**\*INITIAL\_INTERNAL\_DOF\_SOLID\_{OPTION}**

Valid OPTIONS are TYPE3 and TYPE4.

Purpose: Initialize the internal degrees of freedom for solid element types 3 and 4.

Card 1            1            2            3            4            5            6            7            8

Variable	LID								
Type	I								
Default	none								

Card 2 to N    1            2            3            4            5            6            7            8

Variable	VALX	VALY	VALZ						
Type	F	F	F						
Default	none	none	none						

<u>VARIABLE</u>	<u>DESCRIPTION</u>
LID	Element ID.
LCID	Load curve ID defining preload force versus time. When the load curve ends or goes to zero, the initialization is assumed to be completed. See remark 2 below.
VALX	X component of internal degree of freedom.
VALY	Y component of internal degree of freedom.
VALZ	Z component of internal degree of freedom.

**Remarks:**

1. Type 3 solids require 12 cards (N=13) to initialize the internal degrees of freedom, and the type 4 solids require 6 cards (N=7).
2. The internal degrees of freedom are specified in terms of the displacements of the corresponding mid-side nodes of the 20 node hex and the 10 node tet that are the basis of the type 3 and 4 solid elements, respectively.

**\*INITIAL\_MOMENTUM**

Purpose: Define initial momentum to be deposited in solid elements. This option is to crudely simulate an impulsive type of loading.

Card            1            2            3            4            5            6            7            8

Variable	EID	MX	MY	MZ	DEPT			
Type	I	F	F	F	F			
Default	none	0.	0.	0.	0,			

**VARIABLE**

**DESCRIPTION**

EID	Element ID
MX	Initial x-momentum
MY	Initial y-momentum
MZ	Initial z-momentum
DEPT	Deposition time

**\*INITIAL\_PWP\_DEPTH\_{OPTION}**

The available options include:

<BLANK>

**SET**

Purpose: Initialize pore water pressure in solid elements where a non-hydrostatic profile is required.

Card 1            1            2            3            4            5            6            7            8

Variable	PID/PSID	LC							
Type	I	I							
Default	none	none							

**VARIABLE****DESCRIPTION**

PID	Part ID or Part Set ID for the _SET option
LC	Curve of pore water pressure head (length units) vs Z-coordinate

**Remarks:**

This feature overrides the automatically calculated hydrostatic pressure profile. The points in the curve must be ordered with the most negative z-coordinate first – this order looks “upside-down” on the page.

If a part has pore fluid but no \*INITIAL\_PWP\_DEPTH is defined, the default initial pressure profile is hydrostatic.

**\*INITIAL\_STRAIN\_SHELL\_{OPTION}**

The available options include:

<BLANK>

**SET**

Purpose: Initialize strain tensor for shell element. This option is primarily for multi-stage metal forming operations where the accumulated strain is of interest.

Define as many shell elements in this section as desired. The input is assumed to terminate when a new keyword is detected. These strain tensors are defined at the inner and outer integration points and are used for post-processing only. There is no interpolation with this option and the strains are defined in the global Cartesian coordinate system. The \*DATABASE\_EXTENT\_BINARY flag STRFLG must be set to unity for this option to work. When OPTION is blank, uses have the option to define strains at all integration points by providing nonzero NPLANE, NTHICK and setting INTOUT flag of \*DATABASE\_EXTENT\_BINARY to either "STRAIN" or "ALL"..

Card 1            1            2            3            4            5            6            7            8

Variable	EID	NPLANE	NTHICK						
Type	I	I	I						
Default	none	none	none						

**When NPLANE and NTHICK are defined, define NPLANE X NTHICK cards below. For each through thickness point define NPLANE points. NPLANE should be either 1 or 4 corresponding to either 1 or 4 Gauss integration points. If four integration points are specified, they should be ordered such that their in plane parametric coordinates are at:**

$$\left(-\frac{\sqrt{3}}{3}, -\frac{\sqrt{3}}{3}\right), \left(\frac{\sqrt{3}}{3}, -\frac{\sqrt{3}}{3}\right), \left(\frac{\sqrt{3}}{3}, \frac{\sqrt{3}}{3}\right), \left(-\frac{\sqrt{3}}{3}, \frac{\sqrt{3}}{3}\right),$$

**respectively.**

When **NPLANE** and **NTHICK** are not defined, define two cards below, one for the inner integration point and the other for the outer integration point, respectively.

Card 2,...      1            2            3            4            5            6            7            8

Variable	EPSxx	EPSyy	EPSzz	EPSxy	EPSyz	EPSzx	T	
Type	F	F	F	F	F	F	F	
Default	none	none	none	0			0.	

**VARIABLE****DESCRIPTION**

EID	Element ID or shell element set ID when the <b>SET</b> option is used.
NPLANE	Number of in-plane integration points being output.
NTHICK	Number of integration points through the thickness.
EPSij	Define the ij strain component. The strains are defined in the GLOBAL Cartesian system.
T	Parametric coordinate of through thickness integration point between -1 and 1 inclusive.

**\*INITIAL\_STRAIN\_SOLID\_{OPTION}**

The available options include:

<BLANK>

**SET**

Purpose: Initialize strain tensor at element center. This option can be used for multi-stage metal forming operations where the accumulated strain is of interest. This option is available starting in Release 3 of version 971.

Define as many solid elements in this section as desired. The input is assumed to terminate when a new keyword is detected. These strain tensors are defined at the element center and are used for post-processing only. The strains are defined in the global cartesian coordinate system. The \*DATABASE\_EXTENT\_BINARY flag STRFLG must be set to unity for this option to work. This capability is not available for the cohesive element since it is based on displacements, not strains.

Card 1            1            2            3            4            5            6            7            8

Variable	EID								
Type	I								
Default	none								

**Define one card below.**

Card 2,...        1            2            3            4            5            6            7            8

Variable	EPSxx	EPSyy	EPSzz	EPSxy	EPSyz	EPSzx		
Type	F	F	F	F	F	F		

<u>VARIABLE</u>	<u>DESCRIPTION</u>
EID	Element ID or solid element set ID when the <b>SET</b> option is used.
EPSij	Define the ij strain component. The strains are defined in the GLOBAL cartesian system.

**\*INITIAL\_STRAIN\_TSHELL**

Purpose: Initialize the strain tensors for thick shell elements..

Strain tensors are defined at the inner and outer integration points and are used for post-processing only. Strain tensors are defined in the global Cartesian coordinate system. The STRFLG flag on \*DATABASE\_EXTENT\_BINARY must be set to unity for this option to work. Initialize as many elements as needed. For each element, define cards 1, 2, and 3, where card 2 is for the inner layer and card 3 is for the outer layer. The input is assumed to terminate when a new keyword is detected

Card 1            1            2            3            4            5            6            7            8

Variable	EID								
Type	I								
Default	none								

Cards 2, 3.       1            2            3            4            5            6            7            8

Variable	EPSxx	EPSyy	EPSzz	EPSxy	EPSyz	EPSzx		
Type	F	F	F	F	F	F		
Default	0	0	0	0	0	0	.	

**VARIABLE****DESCRIPTION**

EID	Element ID.
EPSij	Define the ij strain component. The strains are defined in the GLOBAL Cartesian system.



**\*INITIAL\_STRESS\_BEAM**

Purpose: Initialize stresses and plastic strains in the Hughes-Liu beam elements, and the axial force and moment resultants Belytschko-Schwer beam elements.

Define as many beams in this section as desired. The input is assumed to terminate when a new keyword is detected.

Card 1            1            2            3            4            5            6            7            8

Variable	EID	RULE	NPTS	LOCAL				
Type	I	I	I	I				
Default	none	none	none	0				

**For the Belytschko-Schwer beam define 1 card.**

Card 2            1            2            3            4            5            6            7            8

Variable	F11	T11	M12	M13	M22	M23	PARAM	
Type	F	F	F	F	F	F	F	

**For the Hughes-Liu beams define NTPS cards below, one per integration point.**

Card 2,...        1            2            3            4            5            6            7            8

Variable	SIG11	SIG22	SIG33	SIG12	SIG23	SIG31	EPS	
Type	F	F	F	F	F	F	F	

<u>VARIABLE</u>	<u>DESCRIPTION</u>
EID	Element ID

---

<b>VARIABLE</b>	<b>DESCRIPTION</b>
RULE	Integration rule type number: EQ.1.0: $1 \times 1$ Gauss quadrature EQ.2.0: $2 \times 2$ Gauss quadrature (default beam), EQ.3.0: $3 \times 3$ Gauss quadrature, EQ.4.0: $3 \times 3$ Lobatto quadrature, EQ.5.0: $4 \times 4$ Gauss quadrature.
NPTS	Number of integration points. For the Belytschko-Schwer resultant beam element, NPTS=1.
LOCAL	Coordinate system for stresses: EQ.0: stress components are defined in the global coordinate system. EQ.1: stress components are defined in the local beam system. In the local system components SIG22, SIG33, and SIG23 are set to 0.0.
F11	Axial force resultant along local beam axis 1.
T11	Torsional moment resultant about local beam axis 1
M12	Moment resultant at node 1 about local beam axis 2.
M13	Moment resultant at node 1 about local beam axis 3
M22	Moment resultant at node 2 about local beam axis 2
M23	Moment resultant at node 2 about local beam axis 3
PARM	Generally not used.
SIGIJ	Define the IJ stress component.
EPS	Effective plastic strain

**\*INITIAL\_STRESS\_DEPTH\_{OPTION}**

Available options include:

<BLANK>

**SET**

Purpose: Initialize solid element stresses where stress is a function of depth.

Card 1            1            2            3            4            5            6            7            8

Variable	PID/PSID	RO_G	ZDATUM	KFACT	LC	LCH	LCK0	
Type	I	F	F	F	I	I	I	
Default	none	none	none	0.0	none	none	none	

<u>VARIABLE</u>	<u>DESCRIPTION</u>
PID/PSID	Part ID or Part Set ID for the _SET option
RO_G	Stress per unit elevation above datum (usually = density x gravity)
ZDATUM	Z-coordinate of datum
KFACT	X- and Y-stress = KFACT x Z-stress
LC	Optional curve of stress vs z-coordinate (ZDATUM is ignored with this option)
LCH	Optional curve of horizontal stress versus z-coordinate (KFACT is ignored with this option)
LVK0	Optional curve of K0 (ratio of horizontal_stress/vertical_stress) versus z-coordinate. KFACT and LCH are ignored with this option. The x-axis of the curve is the z-coordinate, the y-axis is K0.

**Remarks:**

Z-stress = RO\_G × (Z<sub>element</sub> - ZDATUM) . To generate compressive stresses, the datum should be above the highest element – usually at the surface of the soil in geotechnics simulations. If the

curve is present, it overrides RO\_G and ZDATUM. Note that the points in the curve should be ordered with most negative z-coordinate first – this order looks “upside-down” on the page.

First, select how the vertical stress as a function of z-coordinate will be defined (either RO\_G and ZDATUM, or LC). Next, select how the horizontal stress will be defined (either a constant factor KFACT times the vertical stress; or a factor that varies with z-coordinate times the vertical stress using LCK0; or a curve of horizontal stress versus depth LCH).

If pore water is present, the stresses input here are effective (soil skeleton stresses only). The pore water pressures will automatically be initialized to hydrostatic, or by \*INITIAL\_PWP\_DEPTH or \*BOUNDARY\_PWP\_TABLE if those cards are present.

For a 2D problem (axisymmetric or plane strain), replace Z in above documentation with Y.

**\*INITIAL\_STRESS\_SECTION**

Purpose: Initialize the stress in solid elements that are part of a section definition to create a preload. The stress component in the direction normal to the cross-section plane is initialized. This option works with a subset of materials that are incrementally updated including the elastic, viscoelastic, and elastoplastic materials. Rubbers, foams, and materials that are combined with equations-of-state cannot be initialized by this approach. NEW: Hyperelastic materials # 57, 73 and 83 can be initialized with this approach.

Card 1            1            2            3            4            5            6            7            8

Variable	ISSID	CSID	LCID	PSID	VID			
Type	I	A8	I	I	I			
Default	none	none	none	none	none			

<u>VARIABLE</u>	<u>DESCRIPTION</u>
ISSID	Section stress initialization ID.
CSID	Cross-section ID. See *DATABASE_CROSS_SECTION.
LCID	Load curve ID defining preload stress versus time. When the load curve ends or goes to zero, the initialization is assumed to be completed. See remark 2 below.
PSID	Part set ID.
VID	Vector ID defining the direction normal to the cross section. This vector must be defined if *DATABASE_CROSS_SECTION_SET is used to define the cross section. If the cross section is defined using the PLANE option, the normal used in the definition of the plane is used if VID is left undefined.

**Remarks:**

1. To achieve convergence during explicit dynamic relaxation, the application of the damping options is very important. If contact is active, contact damping is recommended with a value between 10-20 percent. Additional damping, via the option DAMPING\_PART\_STIFFNESS also speeds convergence where a coefficient of 0.10 is effective. If damping is not used, convergence may not be possible.

2. When defining the load curve, LCID, a ramp starting at the origin should be used to increase the stress to the desired value. The time duration of the ramp should produce a quasi-static response. When the end of the load curve is reached, or when the value of the load decreases from its maximum value, the initialization stops. If the load curve begins at the desired stress value, i.e., no ramp, convergence will take much longer, since the impulsive like load created by the initial stress can excite nearly every frequency in the structural system where stress is initialized.
3. This option currently applies only to materials that are incrementally updated. Hyperelastic materials and materials that require an equation-of-state are not currently supported.
4. Solid elements types 1, 2, 3, 4, 9, 10, 13, 15, 16, 17, and 18 are supported. ALE elements are not supported.

**\*INITIAL\_STRESS\_SHELL\_{OPTION}**

Available options include:

**<BLANK>**

**SET**

Purpose: Initialize stresses, history variables, and the effective plastic strain for shell elements.

Define as many shell elements or shell element sets in this section as desired. The input is assumed to terminate when a new keyword is detected. It is not necessary for the location of the through thickness integration points to match those used in the elements which are initialized. The data will be interpolated by LS-DYNA.

Card 1            1            2            3            4            5            6            7            8

Variable	EID/SID	NPLANE	NTHICK	NHISV	NTENSR	LARGE	NTHINT	NTHHSV
Type	I	I	I	I	I	I	I	I
Default	none	none	none	0	0	0	0	0

**Define NPLANE X NTHICK cards below, one (if NHISV=0 and LARGE=0) or two (if NHISV=0 and LARGE=1) per integration point. Include optional cards as necessary to define the NHISV history variable. For each through thickness point define NPLANE points. NPLANE should be either 1 or 4 corresponding to either 1 or 4 Gauss integration points. If four integration points are specified, they should be ordered such that their in plane parametric coordinates are at:**

$$\left(-\frac{\sqrt{3}}{3}, -\frac{\sqrt{3}}{3}\right), \left(\frac{\sqrt{3}}{3}, -\frac{\sqrt{3}}{3}\right), \left(\frac{\sqrt{3}}{3}, \frac{\sqrt{3}}{3}\right), \left(-\frac{\sqrt{3}}{3}, \frac{\sqrt{3}}{3}\right),$$

**respectively.**

# \*INITIAL

# \*INITIAL\_STRESS\_SHELL

If **LARGE=0**, then define the following cards.

Card 2...            1            2            3            4            5            6            7            8

Variable	T	SIGXX	SIGYY	SIGZZ	SIGXY	SIGYZ	SIGZX	EPS
Type	F	F	F	F	F	F	F	F

Optional            1            2            3            4            5            6            7            8

Variable	HISV1	HISV2	HISV3	HISV4	HISV5	HISV6	HISV7	HISV8
Type	F	F	F	F	F	F	F	F

Optional            1            2            3            4            5            6            7            8

Variable	TENXX	TENYY	TENZZ	TENXY	TENYZ	TENZX		
Type	F	F	F	F	F	F		

If **LARGE=1**, then define the following cards.

Card 2            1            2            3            4            5

Variable	T	SIGXX	SIGYY	SIGZZ	SIGXY
Type	F	F	F	F	F

Card 3...            1            2            3            4            5

Variable	SIGYZ	SIGZX	EPS		
Type	F	F	F		



Optional            1                            2                            3                            4                            5

Variable	HISV1	HISV2	HISV3	HISV4	HISV5
Type	F	F	F	F	F

Optional            1                            2                            3                            4                            5

Variable	TENXX	TENYY	TENZZ	TENXY	TENYZ
Type	F	F	F	F	F

Optional            1                            2                            3                            4                            5

Variable	TENZX				
Type	F				

**Define NTHINT sets of cards with NTHHSV number of parameters for each set on the following format (LARGE=1)**

**Cards for integration point 1**

Card 1                1                            2                            3                            4                            5

Variable	THHSV_1_1	THHSV_1_2	THHSV_1_3	THHSV_1_4	THHSV_1_5
Type	F	F	F	F	F

Card 2...            1                            2                            3                            4                            5

Variable	THHSV_1_6	THHSV_1_7	THHSV_1_8	...	
Type	F	F	F		

**Cards for integration point 2**

Card 2            1                            2                            3                            4                            5

Variable	THHSV_2_1	THHSV_2_2	THHSV_2_3	THHSV_2_4	THHSV_2_5
Type	F	F	F	F	F

Card 2...            1                            2                            3                            4                            5

Variable	THHSV_2_6	THHSV_2_7	THHSV_2_8	...	
Type	F	F	F		

**VARIABLE****DESCRIPTION**

EID/SID	Element ID or shell set ID, see *SET_SHELL_....
NPLANE	Number of in plane integration points being output.
NTHICK	Number of integration points through the thickness.
NHISV	Number of additional history variables.
NTENSR	Number of components of tensor data taken from the element history variables stored.
LARGE	Format size (0:off or 1:on). See cards above.
T	Parametric coordinate of through thickness integration point between -1 and 1 inclusive.

---

<b>VARIABLE</b>	<b>DESCRIPTION</b>
SIGij	Define the ij stress component. The stresses are defined in the GLOBAL cartesian system.
EPS	Effective plastic strain
HISVn	Define the nth history variable.
TENij	Define the ijth component of the tensor taken from the history variables. The tensor is defined in the GLOBAL Cartesian system. Define enough lines to provide a total of NTENSOR components, stored six components per line. This applies to material 190 only.
NTHINT	Number of thermal integration points
NTHHSV	Number of thermal history variables per thermal integration point.
THHSV_M_N	N:th history variable at the M:th thermal integration point

**\*INITIAL\_STRESS\_SOLID**

Purpose: Initialize stresses and plastic strains for solid elements. This command is not applicable to hyperelastic materials or any material model based on a Total Lagrangian formulation. Furthermore, for \*mat\_005, \*mat\_014, and any material that requires an equation-of-state (\*EOS), the initialized stresses are deviatoric stresses, not total stresses.

Define as many solid elements in this section as desired. The input is assumed to terminate when a new keyword is detected. If eight points are defined for 1 point LS-DYNA solid elements, the average value will be taken.

Card 1            1            2            3            4            5            6            7            8

Variable	EID	NINT	NHISV	LARGE	IVEFLG		NTHINT	NTHHSV
Type	I	I	I	I	I		I	I
Default	none	none	0	0	0		0	0

**Define NINT cards below, one per integration point. NINT should be either 1 or 8. If eight Gauss integration points are specified, they should be ordered such that their parametric coordinates are located at:**

$$\left(-\frac{\sqrt{3}}{3}, -\frac{\sqrt{3}}{3}, -\frac{\sqrt{3}}{3}\right), \left(\frac{\sqrt{3}}{3}, -\frac{\sqrt{3}}{3}, -\frac{\sqrt{3}}{3}\right), \left(\frac{\sqrt{3}}{3}, \frac{\sqrt{3}}{3}, -\frac{\sqrt{3}}{3}\right), \left(-\frac{\sqrt{3}}{3}, \frac{\sqrt{3}}{3}, -\frac{\sqrt{3}}{3}\right),$$

$$\left(-\frac{\sqrt{3}}{3}, -\frac{\sqrt{3}}{3}, \frac{\sqrt{3}}{3}\right), \left(\frac{\sqrt{3}}{3}, -\frac{\sqrt{3}}{3}, \frac{\sqrt{3}}{3}\right), \left(\frac{\sqrt{3}}{3}, \frac{\sqrt{3}}{3}, \frac{\sqrt{3}}{3}\right), \left(-\frac{\sqrt{3}}{3}, \frac{\sqrt{3}}{3}, \frac{\sqrt{3}}{3}\right),$$

**respectively.**

**If LARGE=0, then define the following cards, no history variables are allowed.**

Card 2...            1            2            3            4            5            6            7            8

Variable	SIGXX	SIGYY	SIGZZ	SIGXY	SIGYZ	SIGZX	EPS	
Type	F	F	F	F	F	F	F	

If **LARGE=1**, then define the following card sets for each integration point. If **NHISV>3** define as many additional cards as necessary. If **IVEFLG** equals 1 or 2 the last history variables are the initial element volume, **IVEFLG=1**, or the initial element volume plus the internal energy density per unit initial volume, **IVEFLG=2**. The specification of energy provides way of initializing pressure in elements which use constitutive models which require energy dependent equations-of-state.

Card 2                    1                    2                    3                    4                    5

Variable	SIGXX	SIGYY	SIGZZ	SIGXY	SIGYZ
Type	F	F	F	F	F

Card 3...                1                    2                    3                    4                    5

Variable	SIGZX	EPS	HISV1	HISV2	HISV3
Type	F	F	F	F	F

Card 4...                1                    2                    3                    4                    5

Variable	HISV...	HISV...	HISV <sub>n-2</sub>	INITVOL	ENERGY
Type	F	F	F	F	F

Define **NTHINT** sets of cards with **NTHHSV** number of parameters for each set on the following format (**LARGE=1**).

#### Cards for integration point 1:

Card 1                    1                    2                    3                    4                    5

Variable	THHSV_1_1	THHSV_1_2	THHSV_1_3	THHSV_1_4	THHSV_1_5
Type	F	F	F	F	F

Card 2...            1                            2                            3                            4                            5

Variable	THHSV_1_6	THHSV_1_7	THHSV_1_8	...	
Type	F	F	F		

**Cards for integration point 2**

Card 1                1                            2                            3                            4                            5

Variable	THHSV_2_1	THHSV_2_2	THHSV_2_3	THHSV_2_4	THHSV_2_5
Type	F	F	F	F	F

Card 2...            1                            2                            3                            4                            5

Variable	THHSV_2_6	THHSV_2_7	THHSV_2_8	...	
Type	F	F	F		

**VARIABLE****DESCRIPTION**

EID	Element ID
NINT	Number of integration points (should correspond to the solid element formulation).
NHISV	Number of additional history variables, which is typically equal to the number of history variables stored at the integration point + IVEFLG. If NHISV exceeds the number of integration point history variables required by the constitutive model, only the number required is output; therefore, if in doubt, set NHISV to a large number.
LARGE	Format size, if zero, NHISV must also be set to zero (this is the format used by LS-DYNA versions 970 and earlier) and, if set to 1, a larger format is used and NHISV is used.

---

<u>VARIABLE</u>	<u>DESCRIPTION</u>
IVEFLG	Initial Volume/energy flag ( <b>only used in large format</b> ) EQ.0:last history variable is used as normal, EQ.1:last history variable is used as the initial volume of the element. One additional history variable is required if IVFLG=1 EQ.2:last two history variables are used to define the initial volume and the internal energy per unit initial volume. Two additional history variables are must be allocated, see NHISV above, if IVFLG=2. If the initial volume is set to zero, the actual element volume is used.
SIGij	Define the ijth stress component. Stresses are defined in the GLOBAL Cartesian system.
EPS	Effective plastic strain.
HISV1...n-1	Define n-1 history variables.
INITVOL	Initial volume (HISVn)
NTHINT	Number of thermal integration points
NTHHSV	Number of thermal history variables per thermal integration point.
THHSV_M_N	N:th history variable at the M:th thermal integration point

**Remarks:**

1. The elastic material model for cohesive elements is a total Lagrangian formulation, and the initial stress will therefore be ignored for it.

# \*INITIAL

# \*INITIAL\_STRESS\_SPH

## \*INITIAL\_STRESS\_SPH

Purpose: Initialize stresses and plastic strains for SPH elements. This command is not applicable to hyperelastic materials or any material model based on a Total Lagrangian formulation. For \*mat\_005, \*mat\_014, and any material that requires an equation-of-state (\*EOS), the initialized stresses are deviatoric stresses, not total stresses.

Define as many SPH elements in this section as desired. The input is assumed to terminate when a new keyword is detected.

Card 1            1            2            3            4            5            6            7            8

Variable	EID	SIGXX	SIGYY	SIGZZ	SIGXY	SIGYZ	SIGZX	EPS
Type	I	F	F	F	F	F	F	F
Default	none	none	none	none	none	none	none	none

### VARIABLE

### DESCRIPTION

EID	SPH particle ID
SIGij	Define the ijth stress component. Stresses are defined in the GLOBAL Cartesian system.
EPS	Effective plastic strain.



## \*INITIAL\_STRESS\_TSHELL

Purpose: Initialize stresses and plastic strains for thick shell elements.

Define as many thick shell elements in this section as desired. The input is assumed to terminate when a new keyword is detected. It is not necessary for the location of the through thickness integration points to match those used in the elements which are initialized. The data will be interpolated by LS-DYNA.

Card 1            1            2            3            4            5            6            7            8

Variable	EID	NPLANE	NTHICK	NHISV	LARGE			
Type	I	I	I	I	I			
Default	none	none	none	0	0			

Define NPLANE\*NTHICK cards below, one per integration point for LARGE=0, or 2 cards for each integration point for LARGE=1. Include optional cards as necessary to define the NHISV history variables. For each through thickness point define NPLANE points. NPLANE should be either 1 or 4 corresponding to either 1 or 4 Gauss integration points. If four integration points are specified, they should be ordered such that their in plane parametric coordinates are at:

$$\left( -\frac{\sqrt{3}}{3}, -\frac{\sqrt{3}}{3} \right), \left( \frac{\sqrt{3}}{3}, -\frac{\sqrt{3}}{3} \right), \left( \frac{\sqrt{3}}{3}, \frac{\sqrt{3}}{3} \right), \left( -\frac{\sqrt{3}}{3}, \frac{\sqrt{3}}{3} \right),$$

respectively.

If LARGE=0, then define the following cards for each integration point. Provide only as many optional cards as needed if NHISV>0. (8E10.0).

Card 2            1            2            3            4            5            6            7            8

Variable	T	SIGXX	SIGYY	SIGZZ	SIGXY	SIGYZ	SIGZX	EPS
Type	F	F	F	F	F	F	F	F

Optional            1            2            3            4            5            6            7            8

Variable	HISV1	HSIV2	HSIV3	HSIV4	HSIV5	HSIV6	HSIV7	HSIV8
Type	F	F	F	F	F	F	F	F

**If LARGE=1, then define the following card sets for each integration point. Provide only as many optional cards as needed if NHISV>0. (5E16.0)**

Card 2                    1                    2                    3                    4                    5

Variable	T	SIGXX	SIGYY	SIGZZ	SIGXY
Type	F	F	F	F	F

Card 3                    1                    2                    3                    4                    5

Variable	SIGYZ	SIGZX	EPS		
Type	F	F	F		

Optional            1            2            3            4            5

Variable	HISV1	HISV2	HISV3	HISV4	HISV5
Type	F	F	F	F	F

**VARIABLE****DESCRIPTION**

EID

Element ID

NPLANE

Number of in plane integration points.

NTHICK

Number of integration points through the thickness.

---

<u>VARIABLE</u>	<u>DESCRIPTION</u>
T	Parametric coordinate of through thickness integration point. between -1 and 1 inclusive.
NHISV	Number of additional history variables.
LARGE	Format size (0:off or 1:on). See cards above.
SIGij	Define the ij stress component. The stresses are defined in the GLOBAL cartesian system.
EPS	Effective plastic strain

**\*INITIAL\_TEMPERATURE\_OPTION**

Available options include:

**NODE**

**SET**

Purpose: Define initial nodal point temperatures using nodal set ID's or node numbers. These initial temperatures are used in a thermal only analysis or a coupled thermal/structural analysis. See also \*CONTROL\_THERMAL\_SOLVER, \*CONTROL\_THERMAL\_TIMESTEP, and CONTROL\_THERMAL\_NONLINEAR.

For thermal loading in a structural only analysis, see \*LOAD\_THERMAL\_OPTION.

Card 1            1            2            3            4            5            6            7            8

Variable	NSID/NID	TEMP	LOC					
Type	I	I	I					
Default	none	0.	0					
Remark	1							

**VARIABLE****DESCRIPTION**

NSID/NID

Nodal set ID or nodal point ID, see also \*SET\_NODES:  
EQ.0: all nodes are included (set option only).

TEMP

Temperature at node or node set.

LOC

Application of surface for thermal shell elements, see parameter, THSHEL, in the \*CONTROL\_SHELL input:  
EQ.-1: lower surface of thermal shell element  
EQ. 0: middle surface of thermal shell element  
EQ. 1: upper surface of thermal shell element

**Remarks:**

1. If a nodal temperature is specified on more than one input card, then the last set input will determine its temperature unless it is specified on a \*INITIAL\_TEMPERATURE\_NODE card.
2. This keyword can be used to define initial nodal point temperatures for SPH particles too by using nodal set ID's or node numbers from SPH particles.

# \*INITIAL

# \*INITIAL\_VEHICLE\_KINEMATICS

## \*INITIAL\_VEHICLE\_KINEMATICS

Purpose: Define initial kinematical information for a vehicle. In its initial orientation, the vehicle's yaw, pitch, and roll axes must be aligned with the global axes. Successive simple rotations are taken about these body fixed axes.

Card 1            1            2            3            4            5            6            7            8

Variable	GRAV	PSID	XO	YO	ZO	XF	YF	ZF
Type	I	I	F	F	F	F	F	F
Default	none	none	0.	0.	0.	0.	0.	0.

Card 2            1            2            3            4            5            6            7            8

Variable	VX	VY	VZ	AAXIS	BAXIS	CAXIS		
Type	F	F	F	I	I	I		
Default	0.	0.	0.	0	0	0		

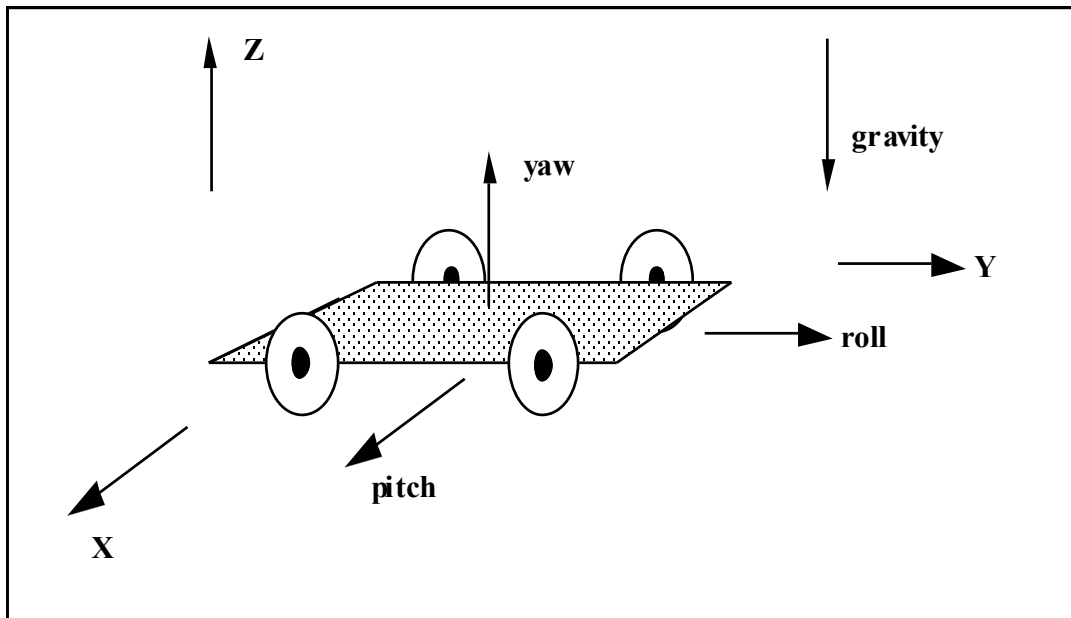
Card 3            1            2            3            4            5            6            7            8

Variable	AANG	BANG	CANG	WA	WB	WC		
Type	F	F	F	F	F	F		
Default	0.	0.	0.	0.	0.	0.		

---

<b>VARIABLE</b>	<b>DESCRIPTION</b>
GRAV	Gravity direction code. EQ. 1: Global +x direction. EQ.-1: Global -x direction. EQ. 2: Global +y direction. EQ.-2: Global -y direction. EQ. 3: Global +z direction. EQ.-3: Global -z direction. Note: this must be the same for all vehicles present in the model.
PSID	Part set ID.
XO	x-coordinate of initial position of mass center.
YO	y-coordinate of initial position of mass center.
ZO	z-coordinate of initial position of mass center.
XF	x-coordinate of final position of mass center.
YF	y-coordinate of final position of mass center.
ZF	z-coordinate of final position of mass center.
VX	x-component of mass center velocity.
VY	y-component of mass center velocity.
VZ	z-component of mass center velocity.
AAXIS	First rotation axis code. EQ.1: Initially aligned with global x-axis. EQ.2: Initially aligned with global y-axis. EQ.3: Initially aligned with global z-axis.
BAXIS	Second rotation axis code.
CAXIS	Third rotation axis code.
AANG	Rotation angle about the first rotation axis (degrees).
BANG	Rotation angle about the second rotation axis (degrees).
CANG	Rotation angle about the third rotation axis (degrees).
WA	Angular velocity component for the first axis (radian/second).

<u>VARIABLE</u>	<u>DESCRIPTION</u>
WB	Angular velocity component for the second axis (radian/second).
WC	Angular velocity component for the third axis (radian/second).



**Figure 21.2.** The vehicle pictured is to be oriented with a successive rotation sequence about the yaw, pitch, and roll axes, respectively. Accordingly, AAXIS=3, BAXIS=1, and CAXIS=2. The direction of gravity is given by GRAV=-3.



**\*INITIAL\_VELOCITY**

Purpose: Define initial nodal point translational velocities using nodal set ID's. This may also be used for sets in which some nodes have other velocities. See NSIDEX below.

Card 1            1            2            3            4            5            6            7            8

Variable	NSID	NSIDEX	BOXID	IRIGID	ICID			
Type	I	I	I	I	I			
Default	none	0	0	0	0			
Remark	1							

Card 2            1            2            3            4            5            6            7            8

Variable	VX	VY	VZ	VXR	VYR	VZR		
Type	F	F	F	F	F	F		
Default	0.	0.	0.	0.	0.	0.		

**Define the following card if and only if NSIDEX>0.**

Card 3            1            2            3            4            5            6            7            8

Variable	VXE	VYE	VZE	VXRE	VYRE	VZRE		
Type	F	F	F	F	F	F		
Default	0.	0.	0.	0.	0.	0.		

<b>VARIABLE</b>	<b>DESCRIPTION</b>
NSID	Nodal set ID, see *SET_NODES, containing nodes for initial velocity: If NSID = 0 the initial velocity is applied to all nodes.
NSIDEX	Nodal set I, see *SET_NODES, containing nodes that are exempted from the imposed velocities and may have other initial velocities.
BOXID	All nodes in box which belong to NSID are initialized. Nodes outside the box are not initialized. Exempted nodes are initialized to velocities defined by VXE, VYE, and VZE below regardless of their location relative to the box.
IRIGID	Option to overwrite rigid body velocities defined on *PART_INERTIA and *CONSTRAINED_NODAL_RIGID_BODY_INERTIA cards. GE.1: part set ID, containing ID of parts to overwrite. Center of gravity of part must lie within box BOXID. If BOXID is not defined then all parts defined in the set are overwritten. EQ.-1: Overwrite velocities for all *PART_INERTIA's and *CONSTRAINED_NODAL_RIGID_BODY_INERTIA's with a center of gravity within box BOXID. If BOXID is not defined then all are overwritten. EQ.-2: Overwrite velocities for all *PART_INERTIA's and *CONSTRAINED_NODAL_RIGID_BODY_INERTIA's.
ICID	Local coordinate system ID. The initial velocity is specified in the local coordinate system if ICID is greater than zero.
VX	Initial velocity in x-direction
VY	Initial velocity in y-direction
VZ	Initial velocity in z-direction
VXR	Initial rotational velocity about the x-axis
VYR	Initial rotational velocity about the y-axis
VZR	Initial rotational velocity about the z-axis
VXE	Initial velocity in x-direction of exempted nodes
VYE	Initial velocity in y-direction of exempted nodes
VZE	Initial velocity in z-direction of exempted nodes
VXRE	Initial rotational velocity in x-direction of exempted nodes

---

<u>VARIABLE</u>	<u>DESCRIPTION</u>
VYRE	Initial rotational velocity in y-direction of exempted nodes
VZRE	Initial rotational velocity in z-direction of exempted nodes

**Remarks:**

1. This generation input must not be used with \*INITIAL\_VELOCITY\_GENERATION keyword.
2. If a node is initialized on more than one input card set, then the last set input will determine its velocity. However, if the nodal velocity is also specified on a \*INITIAL\_VELOCITY\_NODE card, then the velocity specification on this card will be used.
3. Unless the option IRIGID is specified rigid bodies, initial velocities given in \*PART\_INERTIA will overwrite generated initial velocities. The IRIGID option will cause the rigid body velocities specified on the \*PART\_INERTIA input to be overwritten. To directly specify the motion of a rigid body without using the keyword, \*PART\_INERTIA, which also requires the definition of the mass properties, use the keyword option, \*INITIAL\_VELOCITY\_RIGID\_BODY.
4. Nodes which belong to rigid bodies must have motion consistent with the translational and rotational velocity of the center of gravity (c.g.) of the rigid body. During initialization the rigid body translational and rotational rigid body momentum's are computed based on the prescribed nodal velocity field. From this rigid body momentum, the translational and rotational velocities of the nodal points are computed and reset to the new values. These new values may or may not be the same as the values prescribed for the nodes that make up the rigid body. Sometimes this occurs in single precision due to numerical round-off. If a problem like this occurs specify the velocity using the keyword: \*INITIAL\_VELOCITY\_RIGID\_BODY.

# **\*INITIAL**

# **\*INITIAL\_VELOCITY\_NODE**

## **\*INITIAL\_VELOCITY\_NODE**

Purpose: Define initial nodal point velocities for a node.

Card            1            2            3            4            5            6            7            8

Variable	NID	VX	VY	VZ	VXR	VYR	VZR	ICID
Type	I	F	F	F	F	F	F	I
Default	none	0.	0.	0.	0.	0.	0.	0

### VARIABLE

### DESCRIPTION

NID	Node ID
VX	Initial translational velocity in x-direction
VY	Initial translational velocity in y-direction
VZ	Initial translational velocity in z-direction
VXR	Initial rotational velocity about the x-axis
VYR	Initial rotational velocity about the y-axis
VZR	Initial rotational velocity about the z-axis
ICID	Local coordinate system ID. The specified velocities are in the local system if ICID is greater than zero.

See Remarks on \*INITIAL\_VELOCITY card.

**\*INITIAL\_VELOCITY\_RIGID\_BODY**

Purpose: Define the initial translational and rotational velocities at the center of gravity (c.g.) for a rigid body or a nodal rigid body. This input overrides all other velocity input for the rigid body and the nodes which define the rigid body.

Card            1            2            3            4            5            6            7            8

Variable	PID	VX	VY	VZ	VXR	VYR	VZR	ICID
Type	I	F	F	F	F	F	F	I
Default	none	0.	0.	0.	0.	0.	0.	0

**VARIABLE****DESCRIPTION**

PID	Part ID of the rigid body or the nodal rigid body.
VX	Initial translational velocity at the c.g. in global x-direction.
VY	Initial translational velocity at the c.g. in global y-direction.
VZ	Initial translational velocity at the c.g. in global z-direction.
VXR	Initial rotational velocity at the c.g. about the global x-axis.
VYR	Initial rotational velocity at the c.g. about the global y-axis.
VZR	Initial rotational velocity at the c.g. about the global z-axis.
ICID	Local coordinate system ID. The specified velocities are in the local system if ICID is greater than zero.

See remarks 3 and 4 on the \*INITIAL\_VELOCITY input description.

**\*INITIAL\_VELOCITY\_GENERATION**

Purpose: Define initial velocities for rotating and translating bodies. Caution: Rigid body velocities cannot be reinitialized after dynamic relaxation by setting PHASE=1 since rigid body velocities are always restored to the values that existed prior to dynamic relaxation. Reinitialization of velocities after dynamic relaxation is only for nodal points of deformable bodies; therefore, if rigid bodies are present in the part set ID, this input should be defined twice, once for IPHASE=0 and again for IPHASE=1.

Card 1            1            2            3            4            5            6            7            8

Variable	ID	STYP	OMEGA	VX	VY	VZ	IVATN	ICID
Type	I	I	F	F	F	F	I	I
Default	none	none	0.	0.	0.	0.	0	0

Card 2            1            2            3            4            5            6            7            8

Variable	XC	YC	ZC	NX	NY	NZ	PHASE	IRIGID
Type	F	F	F	F	F	F	I	I
Default	0.	0.	0.	0.	0.	0.	0	0

**VARIABLE****DESCRIPTION**

ID                      Part ID, part set ID, or node set ID if zero STYP is ignored and all velocities are set. WARNING if IVATN=0: If a part ID of a rigid body is specified only the nodes that belong to elements of the rigid body are initialized. Nodes defined under the keyword. \*CONSTRAINED\_EXTRA\_NODES are not initialized. Set IVATN=1 to initialize velocities of slaved nodes and parts.

STYP                    Set type:  
                           EQ.1: part set ID, see \*SET\_PART,  
                           EQ.2: part ID, see \*PART,  
                           EQ.3: node set ID, see \*SET\_NODE.

<b>VARIABLE</b>	<b>DESCRIPTION</b>
OMEGA	Angular velocity about the rotational axis.
VX	Initial translational velocity in global x-direction.
VY	Initial translational velocity in global y-direction.
VZ	Initial translational velocity in global z-direction.
IVATN	Flag for setting the initial velocities of slave nodes and parts: EQ.0: slaved parts are ignored. EQ.1: slaved parts and slaved nodes of the master parts will be assigned initial velocities like the master part.
ICID	Local coordinate system ID. The specified velocities are in the local system if ICID is greater than zero. Note that this requires XC, YC, and ZC to also be specified in the local coordinate system.
XC	x-coordinate on rotational axis.
YC	y-coordinate on rotational axis.
ZC	z-coordinate on rotational axis.
NX	x-direction cosine.
NY	y-direction cosine.
NZ	z-direction cosine.
PHASE	Flag specifying phase of the analysis the velocities apply to: EQ.0. Velocities are applied immediately, EQ.1. Velocities are applied after reaching the start time, STIME, which is after dynamic relaxation, if active, is completed. See the keyword: *INITIAL_VELOCITY_GENERATION_START_TIME. STIME defaults to zero.
IRIGID	Option to overwrite or automatically set rigid body velocities defined on the *PART_INERTIA and *CONSTRAINED_NODAL_RIGID_BODY_INERTIA cards. EQ.1: Reset the rigid body velocities for *PART ID or all parts in *SET_PART ID. This option does not apply for STYP=3.

**Remarks:**

1. This generation input must not be used with \*INITIAL\_VELOCITY or \*INITIAL\_VELOCITY\_NODE options.
2. The velocities are initialized in the order the \*INITIAL\_VELOCITY\_GENERATION input is defined. Later input via the \*INITIAL\_VELOCITY\_GENERATION keyword may overwrite the velocities previously set.
3. For rigid bodies, initial velocities given in \*PART\_INERTIA will overwrite generated initial velocities.
4. Nodes which belong to rigid bodies must have motion consistent with the translational and rotational velocity of the rigid body. During initialization the rigid body translational and rotational rigid body momentum's are computed based on the prescribed nodal velocities. From this rigid body motion the velocities of the nodal points are computed and reset to the new values. These new values may or may not be the same as the values prescribed for the node.
5. SPH elements can be initialized using the STYP=3 option only.



**\*INITIAL\_VELOCITY\_GENERATION\_START\_TIME**

**\*INITIAL**

**\*INITIAL\_VELOCITY\_GENERATION\_START\_TIME**

Purpose: Define a time to initialize velocities after time zero. Time zero starts after dynamic relaxation if used for initialization. This option can be applied if and only if PHASE=1 is specified for at least one \*INITIAL\_VELOCITY\_GENERATION definitions.

Card 1            1            2            3            4            5            6            7            8

Variable	STIME							
Type	F							
Default	0.0							

<u>VARIABLE</u>	<u>DESCRIPTION</u>
STIME	Start time.

**\*INITIAL\_VOID\_OPTION**

Available options include:

**PART**

**SET**

Purpose: Define initial voided part set ID's or part numbers. Void materials cannot be created during the calculation. Fluid elements which are evacuated, e.g., by a projectile moving through the fluid, during the calculation are approximated as fluid elements with very low densities. The constitutive properties of fluid materials used as voids must be identical to those of the materials which will fill the voided elements during the calculation. Mixing of two fluids with different properties is not permitted with this option.

Card 1            1            2            3            4            5            6            7            8

Variable	PSID/PID								
Type	I								
Default	none								
Remark	1								

**VARIABLE****DESCRIPTION**

PSID/PID

Part set ID or part ID, see also \*SET\_PART:

**Remarks:**

This void option and multiple materials per element, see \*ALE\_MULTI-MATERIAL\_GROUP are incompatible and cannot be used together in the same run.

**\*INITIAL\_VOLUME\_FRACTION**

Purpose: Define initial volume fractions of different materials in multi-material ALE elements.

Card 1            1            2            3            4            5            6            7            8

Variable	EID	VF1	VF2	VF3	VF4	VF5	VF6	VF7
Type	I	F	F	F	F	F	F	F
Default	none	0.0	0.0	0.0	0.0	0.0	0.0	0.0

<u>VARIABLE</u>	<u>DESCRIPTION</u>
EID	Element ID.
VF1	Volume fraction of multi-material group 1, AMMGID=1.
VF2	Volume fraction of multi-material group 2. Only needed in simulations with 3 material groups. Otherwise VF2=1-VF1.
VF3	Volume fraction of multi-material group 3, AMMGID=3.
VF4	Volume fraction of multi-material group 4, AMMGID=4.
VF5	Volume fraction of multi-material group 5, AMMGID=5.
VF6	Volume fraction of multi-material group 6, AMMGID=6.
VF7	Volume fraction of multi-material group 7, AMMGID=7.

**\*INITIAL\_VOLUME\_FRACTION\_GEOMETRY**

Purpose: This is a volume-filling command for defining the volume fractions of various ALE multi-material groups (AMMG) that can occupy certain regions in some specified ALE mesh set. It is applied only for multi-material ALE model. See Remark 5.

**Defines the background ALE mesh set & an AMMGID that initially fills it.**

Card 1            1            2            3            4            5            6            7            8

Variable	FMSID	FMIDTYP	BAMMG	NTRACE				
Type	I	I	I	I				
Default	none	0	0	3				

**VARIABLE****DESCRIPTION**

FMSID

A background ALE (fluid) mesh SID to be initialized or filled with various AMMG's. This set ID refers to one or more ALE parts.

FMIDTYP

ALE mesh set ID type:

EQ.0: FMSID is an ALE part set ID (PSID).

EQ.1: FMSID is an ALE part ID (PID).

BAMMG

The background fluid group ID or ALE Multi-Material group ID (AMMGID) that initially fills all ALE mesh region defined by FMSID.

NTRACE

Number of sampling points for volume filling detection. Typically NTRACE ranges from 3 to maybe 10 (or more). The higher it is, the finer the ALE element is divided so that small gaps between 2 Lagrangian shells may be filled in. See Remark 6.

Defines the container type and the AMMGID that fills inside or outside it.

Card a            1            2            3            4            5            6            7            8

Variable	CONTTYP	FILLOPT	FAMMG					
Type	I	I	I					
Default	none	0	none					

<u>VARIABLE</u>	<u>DESCRIPTION</u>
CONTTYP	<p>A “container” defines a Lagrangian surface boundary of a spatial region, inside (or outside) of which, an AMMG would fill up. CONTTYP defines the container geometry type of this surface boundary (or shell structure).</p> <p>EQ.1: The container geometry is defined by a part ID (<b>PID</b>) or a part set ID (<b>PSID</b>), where the parts should be defined by shell elements (see *PART or *SET_PART).</p> <p>EQ.2: The container geometry is defined by a <b>segment set</b> (SGSID).</p> <p>EQ.3: The container geometry is defined by a <b>plane</b>: a point and a normal vector.</p> <p>EQ.4: The container geometry is defined by a <b>conical surface</b>: 2 end points and 2 corresponding radii.</p> <p>EQ.5: The container geometry is defined by a <b>cuboid or rectangular box</b>: 2 opposing end points, minimum to maximum coordinates.</p> <p>EQ.6: The container geometry is defined by a <b>sphere</b>: 1 center point, and a radius.</p>
FILLOPT	<p>A flag to indicate which side of the container surface the AMMG is supposed to fill. The “head” side of a container surface/segment is defined as the side pointed to by the heads of the normal vectors of the segments (“tail” side refers to opposite direction to “head”). See Remark 7.</p> <p>EQ.0: The “head” side of the geometry defined above will be filled with fluid (default).</p> <p>EQ.1: The “tail” side of the geometry defined above will be filled with fluid.</p>

<u>VARIABLE</u>	<u>DESCRIPTION</u>
FAMMG	This defines the fluid group ID or ALE Multi-Material group ID (AMMGID) which will fill up the interior (or exterior) of the space defined by the “container”. <u>The order of AMMGIDs are defined by the order in which they are listed under *ALE MULTI-MATERIAL GROUP card.</u> For example, that card defines AMMGID=1 on its first line, and AMMGID=2 on its second line, etc.

**CONTTYP = 1 for container defined by a shell PID or PSID**

Card b-1            1            2            3            4            5            6            7            8

Variable	SID	STYPE	NORMDIR	XOFFSET				
Type	I	I	I	F				
Default	none	0	0	0.0				
Remark			obsolete					

<u>VARIABLE</u>	<u>DESCRIPTION</u>
SID	A Set ID pointing to a part ID (PID) or part set ID (PSID) of the Lagrangian shell element structure defining the “container” geometry to be filled (see *PART or *SET_PART).
SSTYPE	Set ID type: EQ.0: Container SID is a Lagrangian part set ID (PSID). EQ.1: Container SID is a Lagrangian part ID (PID).
NORMDIR	Obsolete (see Remark 7).

<u>VARIABLE</u>	<u>DESCRIPTION</u>
XOFFSET	Absolute length unit for offsetting the fluid interface from the nominal fluid interface LS-DYNA would otherwise define by default. This parameter only applies to GEOTYPE=1 (4 <sup>th</sup> column) and GEOTYPE=2 (3 <sup>rd</sup> column). This is applicable to cases in which high pressure fluid is contained within a container. The offset allows LS-DYNA time to prevent leakage. In general, this may be set to roughly 5-10% of the ALE elm width. It may be important only for when ILEAK is turned ON to give the code time to "catch" the leakage. If ILEAK is not ON, this may not be necessary.

**CONTTYP = 2 for container defined by a SGSID**

Card b-2	1	2	3	4	5	6	7	8
Variable	SGSID	NORMDIR	XOFFSET					
Type	I	I	F					
Default	none	0	0.0					
Remark		obsolete						

<u>VARIABLE</u>	<u>DESCRIPTION</u>
SGSID	Segment Set ID defining the "container", see *SET_SEGMENT.
NORMDIR	Obsolete (see Remark 7).
XOFFSET	Absolute length unit for offsetting the fluid interface from the nominal fluid interface LSDYNA would otherwise define by default. This parameter only applies to GEOTYPE=1 (4 <sup>th</sup> column) and GEOTYPE=2 (3 <sup>rd</sup> column). This is applicable to cases in which high pressure fluid is contained within a container. The offset allows LS-DYNA time to prevent leakage. In general, this may be set to roughly 5-10% of the ALE elm width. It may be important only for when ILEAK is turned ON to give the code time to "catch" the leakage. If ILEAK is not ON, this may not be necessary.

**CONTTYP = 3 for container defined by a PLANE**

Card b-3            1            2            3            4            5            6            7            8

Variable	X0	Y0	Z0	XCOS	YCOS	ZCOS		
Type	F	F	F	F	F	F		
Default	none	none	none	none	none	none		

**VARIABLE****DESCRIPTION**

X0, Y0, Z0

X, Y and Z coordinate of a spatial point on the plane.

X1, Y1, Z1

X, Y and Z direction cosines of the plane normal vector. The filling will occur on the side pointed to by the plane normal vector (or "head" side).

**CONTTYP = 4 for container defined by a Cylinder and Cone.**

Card b-4            1            2            3            4            5            6            7            8

Variable	X0	Y0	Z0	X1	Y1	Z1	R1	R2
Type	F	F	F	F	F	F	F	F
Default	none	none	none	none	none	none	none	none

**VARIABLE****DESCRIPTION**

X0, Y0, Z0

X, Y and Z coordinate of the center of the 1<sup>st</sup> base of the cone.

X1, Y1, Z1

X, Y and Z coordinate of the center of the 2<sup>nd</sup> base of the cone.

R1

Radius of the 1<sup>st</sup> base of the cone

R2

Radius of the 2<sup>nd</sup> base of the cone



**CONTTYP = 5 for container defined by a Rectangular Box**

Card b-5      1            2            3            4            5            6            7            8

Variable	X0	Y0	Z0	X1	Y1	Z1		
Type	F	F	F	F	F	F		
Default	none	none	none	none	none	none		

VARIABLEDESCRIPTION

X0, Y0, Z0

X, Y and Z coordinate of the maximum coordinate of the box.

X1, Y1, Z1

X, Y and Z coordinate of the minimum coordinate of the box.

**CONTTYP = 6 for container defined by a Sphere**

Card b-6      1            2            3            4            5            6            7            8

Variable	X0	Y0	Z0	R0				
Type	F	F	F	F				
Default	none	none	none	none				

VARIABLEDESCRIPTION

X0, Y0, Z0

X, Y and Z coordinate of the center of the sphere.

R0

Radius of the sphere

**Remarks:**

1. After card **1** defining the basic mesh filled by certain fluid group (AMMGID), each “filling action” will require 2 additional lines of input (cards **a** and **b-#**, where **#** is the CONTTYP value). At the minimum there will be 3 cards required for this command (**1**, **a** and **b-#**) for 1 “filling action”.

2. There can be one or more “filling actions” prescribed for each definition of this command. The “filling actions” take place in the prescribed order and the effects are accumulative. The latter filling actions over-write the previous ones. Therefore any complex filling logics will require some planning. For example, the following card sequence, with 2 “filling actions”, is allowable:

**1**

**a** (CONTTYP=1)

**b-1**

**a** (CONTTYP=3)

**b-3**

This sequence of cards prescribes a system of background ALE mesh with 2 “filling actions” to be executed. The 1<sup>st</sup> is a filling of a CONTTYP=1, and the 2<sup>nd</sup> of CONTTYP=3.

3. Card **a** is required for all container geometry types (CONTTYP). Card **b-#** defines the container actual geometry and corresponds to each of the CONTTYP choice.
4. If ELFORM=12 (in \*SECTION\_SOLID) for the ALE mesh to be filled, i.e. single-material-and-void element formulation is used, then the non-void material is automatically referred to as AMMG 1 and the void as AMMG 2. The multi-material groups are implied even though no \*ALE\_MULTI-MATERIAL\_GROUP card is required.
5. A simple ALE background mesh (for example, a cuboid mesh) can be constructed enveloping some Lagrangian shell structure (or container). The ALE region inside this Lagrangian shell container may be filled with one multi-material group (AMMG1), and the outside region with another (AMMG2). This approach simplifies the mesh generation requirements for ALE material parts with complex geometries.
6. Default is NTRACE=3 → total number is  $(2*NTRACE+1)^3 = (7X7X7)$ . This means an ALE element is subdivided into 7X7X7 regions. Each is to be filled in with the appropriate AMMG. An example of this application would be the filling of initial gas between multiple layers of Lagrangian airbag shell elements sharing the same ALE element.
7. The simplest approach is to:  
(a) Set “NORMDIR=0” (default).  
(b) Define the shell (or segment) container with inward normals.  
(c) Using only FILLOPT in card **a** to control which side of the container to fill.

Example:

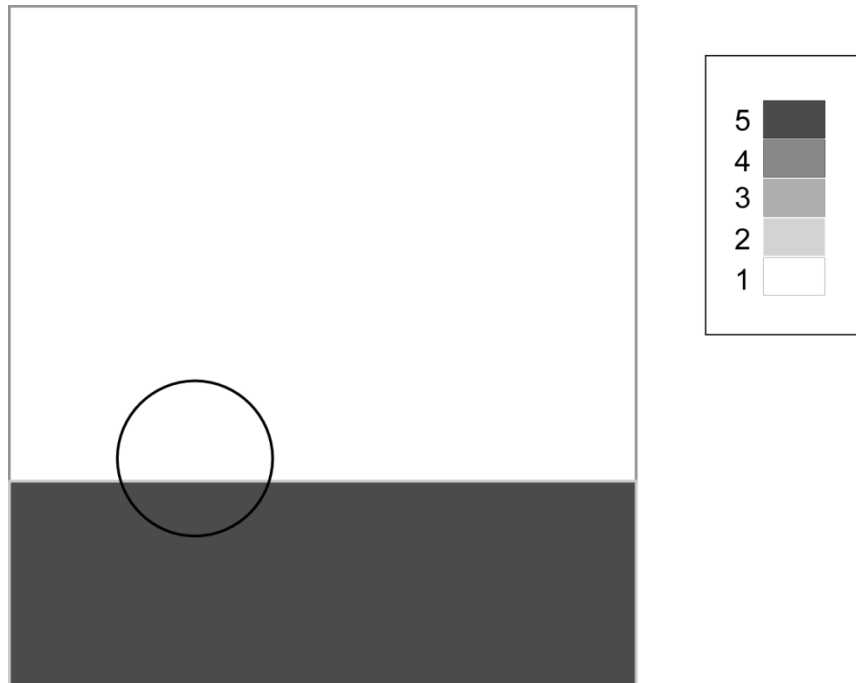
Consider a simple ALE model with ALE parts H1-H5 (5 AMMGs possible) and 1 Lagrangian shell (container) part S6. Only parts H1 and S6 initially have their meshes defined. We will perform 4 "filling actions". The volume filling results after each step will be shown below to clarify the concept used. The input for the volume filling looks like this.

```

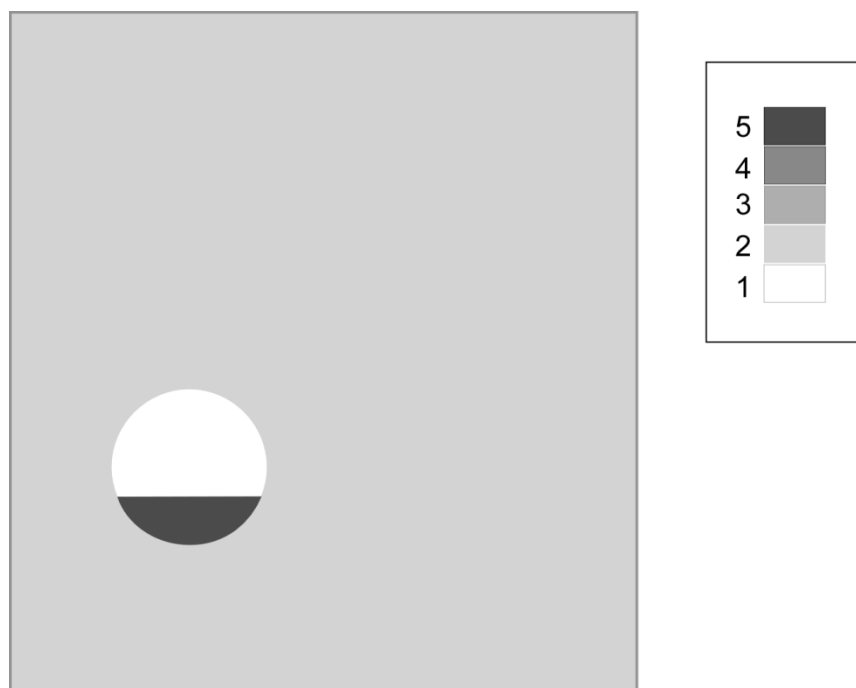
$...|...1...|...2...|...3...|...4...|...5...|...6...|...7...|...8
$ H1 = AMMG 1 = fluid 1 initially occupying whole ALE mesh= background mesh
$ H5 = AMMG 5 = fluid 5 fills below a plane = filling action 1 = CONTTYP=3
$ H2 = AMMG 2 = fluid 2 fills outside S5 = filling action 2 = CONTTYP=1
$ H3 = AMMG 3 = fluid 3 fills inside a cone = filling action 3 = CONTTYP=4
$ H4 = AMMG 4 = fluid 4 fills inside a box = filling action 4 = CONTTYP=5
$ S6 = Lagrangian shell container
$...|...1...|...2...|...3...|...4...|...5...|...6...|...7...|...8
*ALE_MULTI-MATERIAL_GROUP
    1      1
    2      1
    3      1
    4      1
    5      1
*INITIAL_VOLUME_FRACTION_GEOMETRY
$ The 1st card fills the whole pid H1 with AMMG 1=background ALE mesh
$   FMSID  FMIDTYP   BAMMG   <=== card 1: background fluid
    1      1      1
$ filling action 1 = AMMG 5 fill all elms below a plane
$ CONTTYPE  FILLOPT  FILAMMGID   <=== card a : container: CONTTYPE=3=plane
    3      0      5
$   X0, Y0,  Z0,   NX,  NY,  NZ   <=== card b-3: details on container =plane
 25.0,20.0, 0.0,  0.0,-1.0,0.0
$ filling action 2: AMMG 2 fills OUTSIDE (FILLOPT=1) shell S6 (inward normals);
$ CONTTYPE  FILLOPT   FAMMG <== card a : container #1; FILLOPT=1=fill tail
    1      1      2
$   SETID  SETTYPE  NORMDIR <== card b-1: details on container #1
    6      1      0
$ filling action 3 = AMMG 3 fill all elms inside a CONICAL region
$ CONTTYPE  FILLOPT   FAMMG  CONTTYP = 4 = Container = conical region
    4      0      3
$   X1      Y1      Z1      X2      Y2      Z2      R1      R2
 25.0      75.0      0.0      25.0      75.0      1.0      8.0      8.0
$ filling action 4 = AMMG 4 fill all elms inside a BOX region
$ CONTTYPE  FILLOPT  FFLUIDID   : CONTTYP=5 = "BOX"
    5      0      4
$   XMIN      YMIN      ZMIN      XMAX      YMAX      ZMAX
 65.0      35.0      0.0      85.0      65.0      1.0
$...|...1...|...2...|...3...|...4...|...5...|...6...|...7...|...8

```

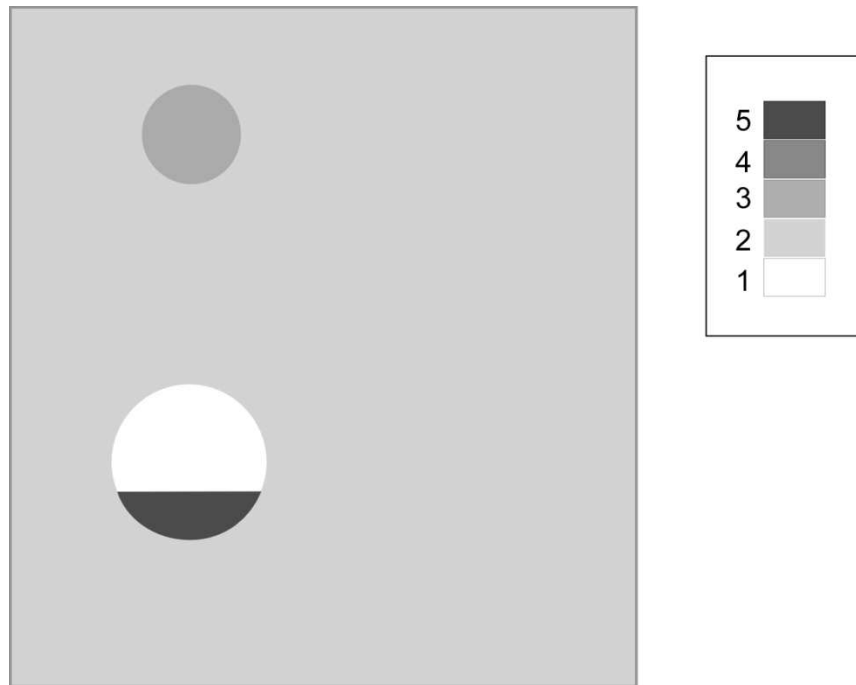
Before the 1<sup>st</sup> “filling action” the whole ALE mesh of part H1 is filled with AMMG 1 (white).  
After the 1<sup>st</sup> “filling action”, AMMG 5 fills below the specified plane.



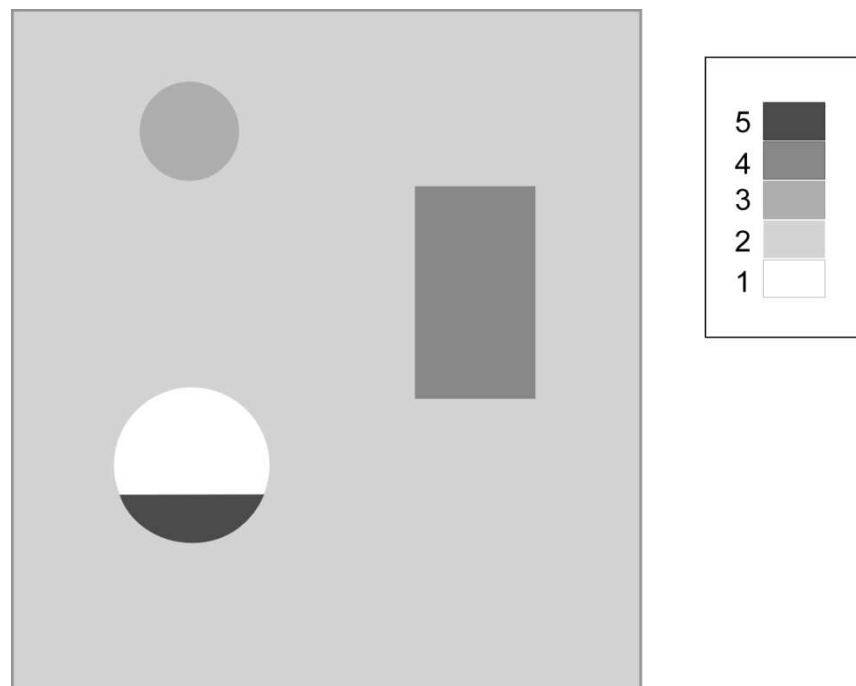
After the 1<sup>st</sup> and 2<sup>nd</sup> “filling actions”, it fills outside the shell (S6) with AMMG 2.



After the 1<sup>st</sup>, 2<sup>nd</sup> and 3<sup>rd</sup> “filling actions”, it fills in the analytical sphere with AMMG 3.



After the 1<sup>st</sup>, 2<sup>nd</sup>, 3<sup>rd</sup> and 4<sup>th</sup> “filling actions”, it fills in the analytical box with AMMG 4.





# **\*INTEGRATION**

In this section the user defined integration rules for beam and shell elements are specified. IRID refers to integration rule identification number on \*SECTION\_BEAM and \*SECTION\_SHELL cards respectively. Quadrature rules in the \*SECTION\_SHELL and \*SECTION\_BEAM cards need to be specified as a negative number. The absolute value of the negative number refers to user defined integration rule number. Positive rule numbers refer to the built in quadrature rules within LS-DYNA. The keyword cards in this section are:

**\*INTEGRATION\_BEAM**

**\*INTEGRATION\_SHELL**

# \*INTEGRATION

# \*INTEGRATION\_BEAM

## \*INTEGRATION\_BEAM

Purpose: Define user defined through the thickness integration rules for the beam element.

Card 1            1            2            3            4            5            6            7            8

Variable	IRID	NIP	RA	ICST	K			
Type	I	I	F	I	I			
Default	none	0	0.0	0	0			

**Define the following card if and only if ICST>0.**

Card            1            2            3            4            5            6            7            8

Variable	D1	D2	D3	D4	SREF	TREF	D5	D6
Type	F	F	F	F	F	F	F	F
Default	none	none	none	none	0.0	0.0	none	none

**Define NIP cards below (Skip if NIP=0).**

Card            1            2            3            4            5            6            7            8

Variable	S	T	WF	PID				
Type	F	F	F	I				

### VARIABLE

### DESCRIPTION

IRID            Integration rule ID. IRID refers to IRID on \*SECTION\_BEAM card.

NIP            Number of integration points, see also ICST.



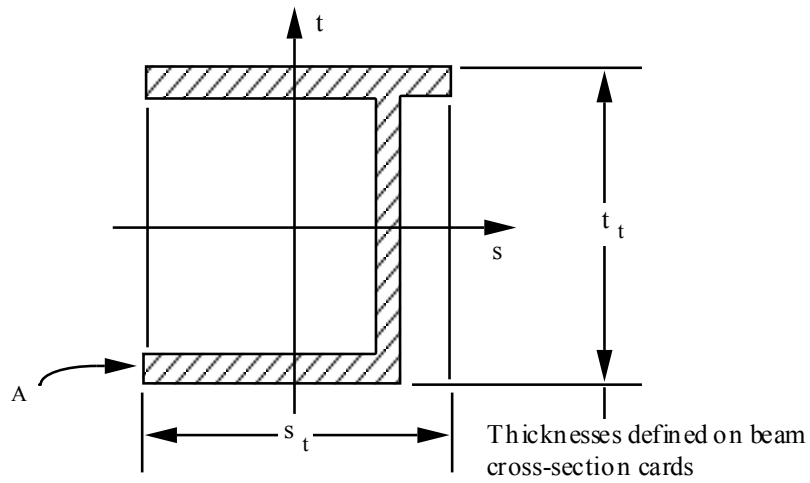
VARIABLE	DESCRIPTION
RA	Relative area of cross section, i.e., the actual cross-sectional area divided by the area defined by the product of the specified thickness in the s direction and the thickness in the t direction. See also ICST below and Figure 22.1.
ICST	Standard cross section type, ICST. If this type is nonzero then NIP and the relative area above should be input as zero. See shapes in Figure 22.3 following Remarks. EQ. 01: I-shape                      EQ. 12: Cross EQ. 02: Channel                      EQ. 13: H-shape EQ. 03: L-shape                      EQ. 14: T-shape1 EQ. 04: T-shape                      EQ. 15: I-shape2 EQ. 05: Tubular box                      EQ. 16: Channel1 EQ. 06: Z-shape                      EQ. 17: Channel2 EQ. 07: Trapezoidal                      EQ. 18: T-shape2 EQ. 08: Circular                      EQ. 19: Box-shape1 EQ. 09: Tubular                      EQ. 20: Hexagon EQ. 10: I-shape1                      EQ. 21: Hat-shape EQ. 11: Solid box                      EQ. 22: Hat-shape1
K	Integration refinement parameter for standard cross section types. Select an integer $\geq 0$ . See Figure below.
D1-D6	Cross-section dimensions. See Figure below.
SREF	$s_{ref}$ , location of reference surface normal to s, for the Hughes-Liu beam only. This option is only useful if the beam is connected to a shell or another beam on its outer surface. Overrides NSLOC in *SECTION_BEAM.
TREF	$t_{ref}$ , location of reference surface normal to t, for the Hughes-Liu beam only. This option is only useful if the beam is connected to a shell or another beam on its outer surface. Overrides NTLOC in *SECTION_BEAM.
S	Normalized s coordinate of integration point, $-1 \leq s \leq 1$ .
T	Normalized t coordinate of integration point, $-1 \leq t \leq 1$ .
WF	Weighting factor, $A_{ii}$ , i.e., the area associated with the integration point divided by actual cross sectional area $A_{ii} = A/A$ , see Figure 22.2.

---

<b>VARIABLE</b>	<b>DESCRIPTION</b>
-----------------	--------------------

---

PID	Optional PID, used to identify material properties for this integration point. If zero, the “master” PID (referenced on *ELEMENT) will be used. This feature will be available in release 3 of version 971.
-----	---



$$\text{Relative Area} = \frac{A}{s_t \cdot t_t}$$

**Figure 22.1.** Definition of relative area for user defined integration rule.

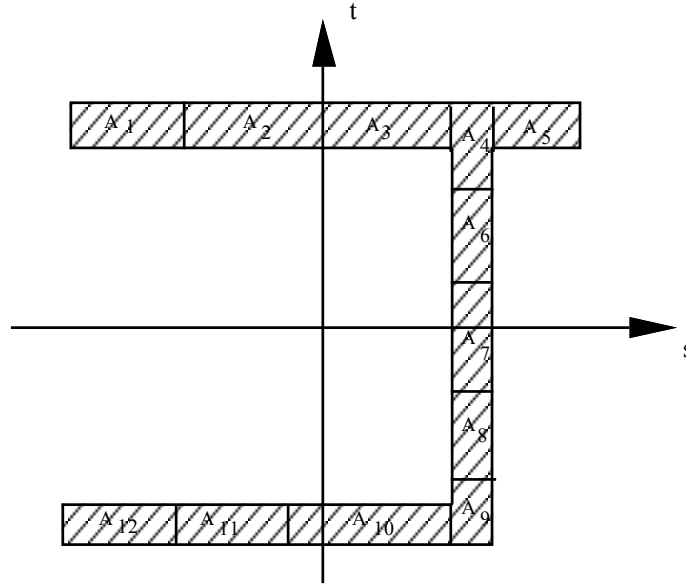


Figure 22.2. Definition of integration points for user defined integration rule.

**Remarks:**

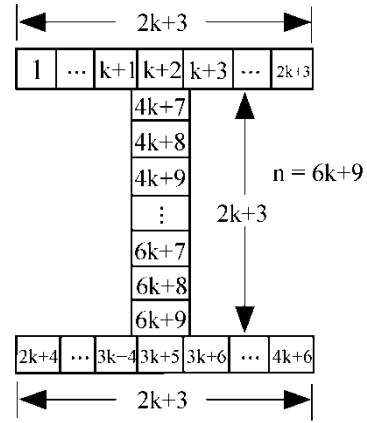
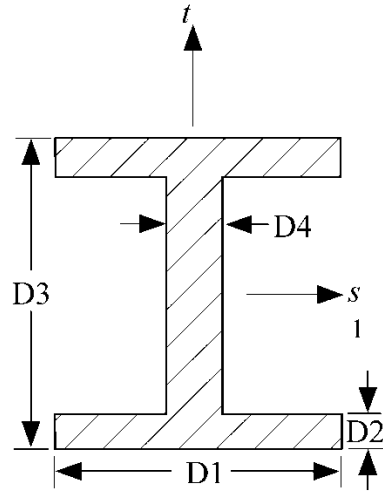
The input for standard beam section types is defined below. In following figures the dimensions are shown on the left and the location of the integration points are shown on the right. If a quantity is not defined in the sketch, then it should be set to zero in the input. The input quantities include:

D1-D6 = Dimensions of section

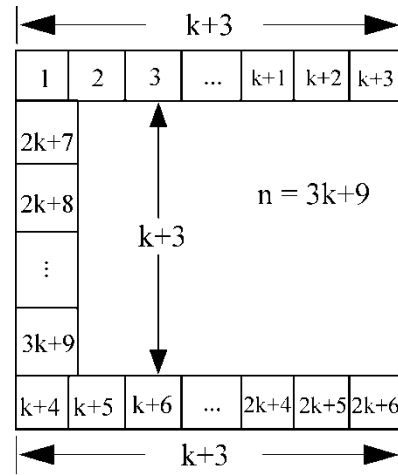
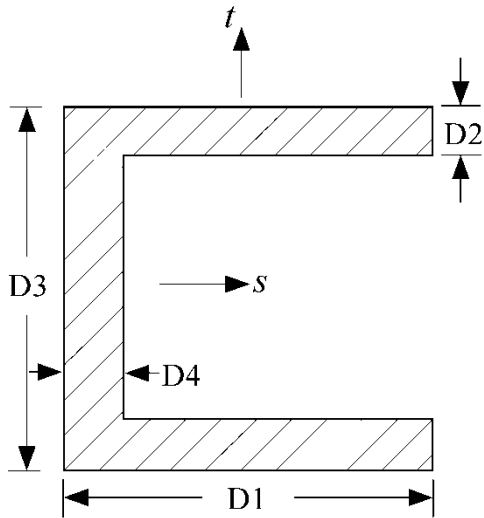
k = Integration refinement parameter ( an integer GE. 0)

s<sub>ref</sub> = location of reference surface normal to s, Hughes-Liu beam only

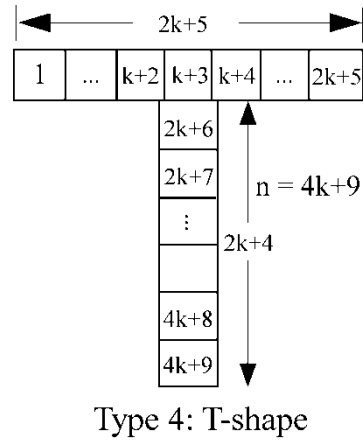
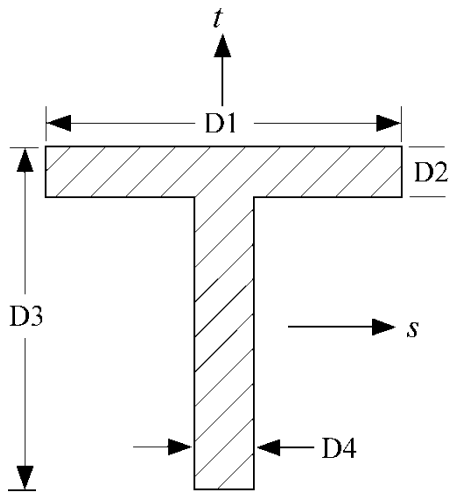
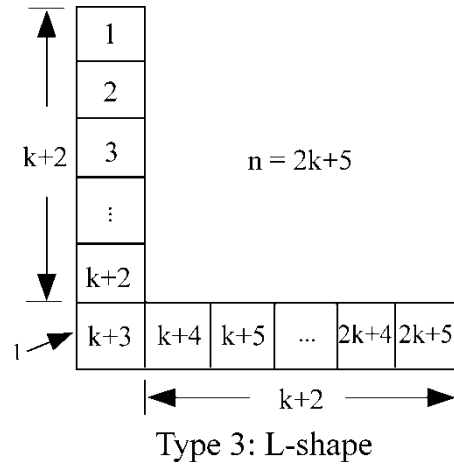
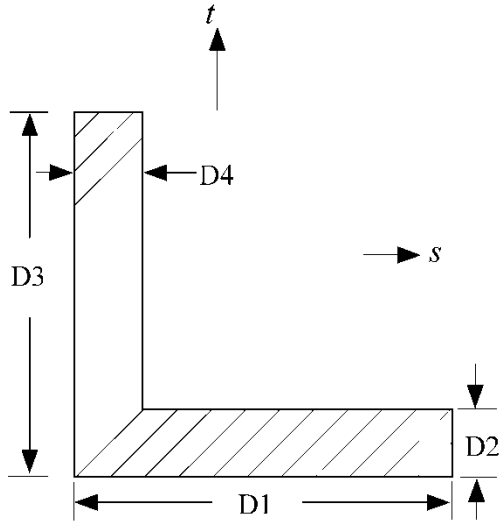
t<sub>ref</sub> = location of reference surface normal to t, Hughes-Liu beam only

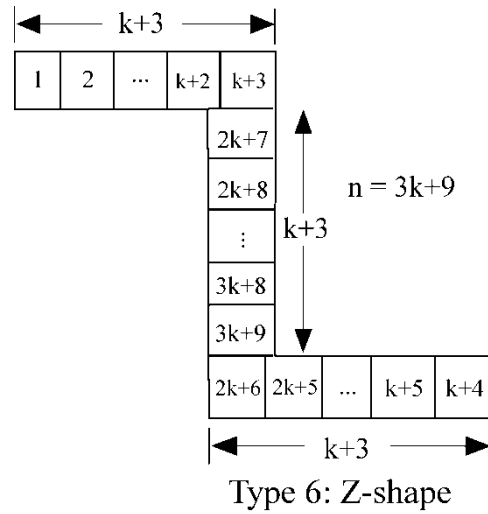
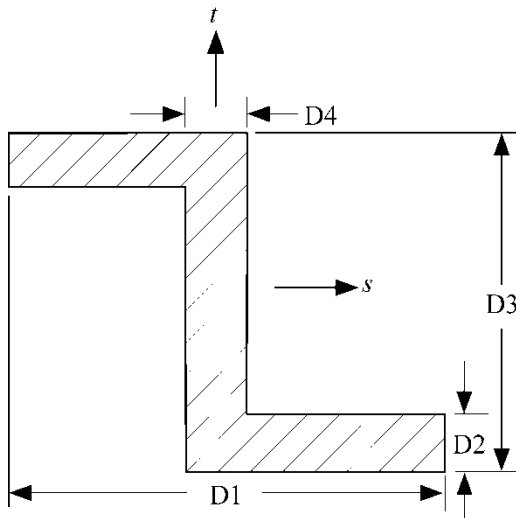
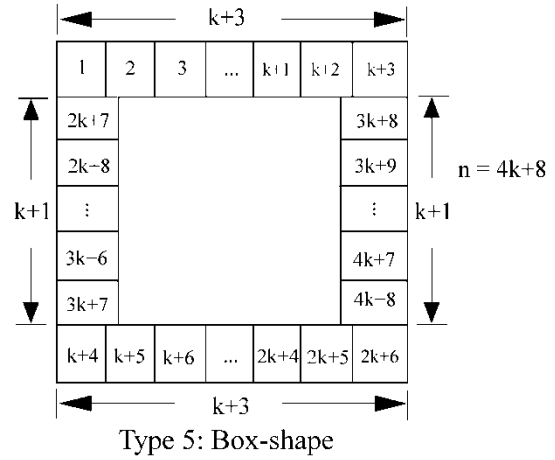
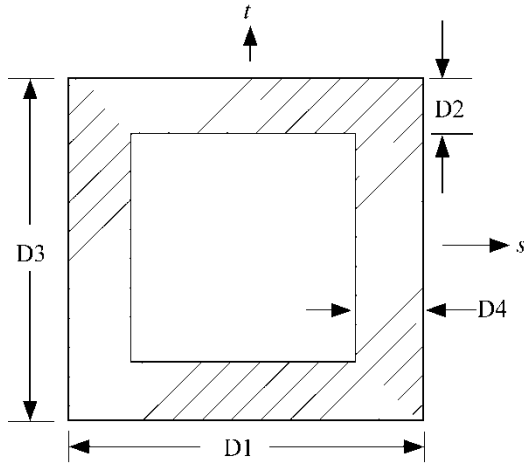


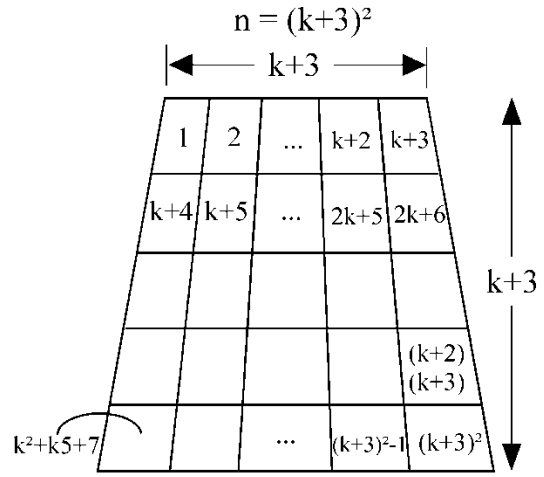
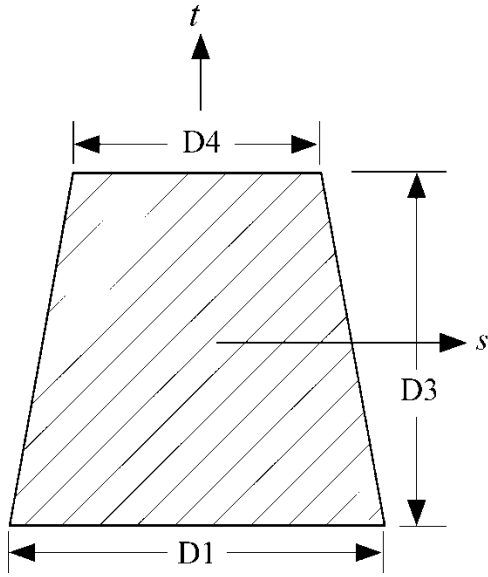
Type 1: I-shape



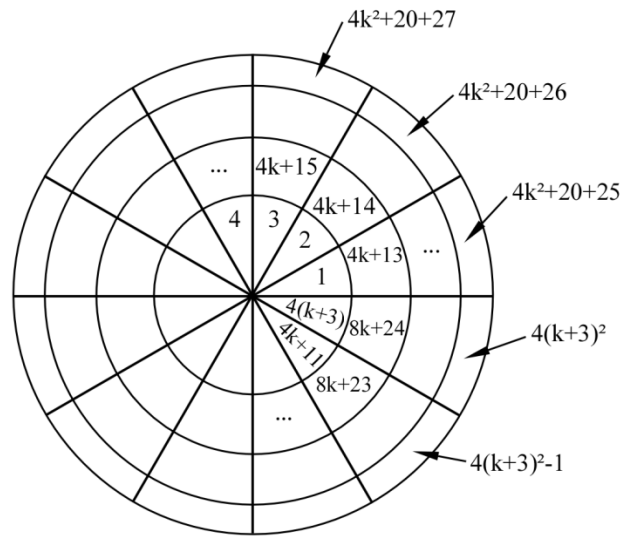
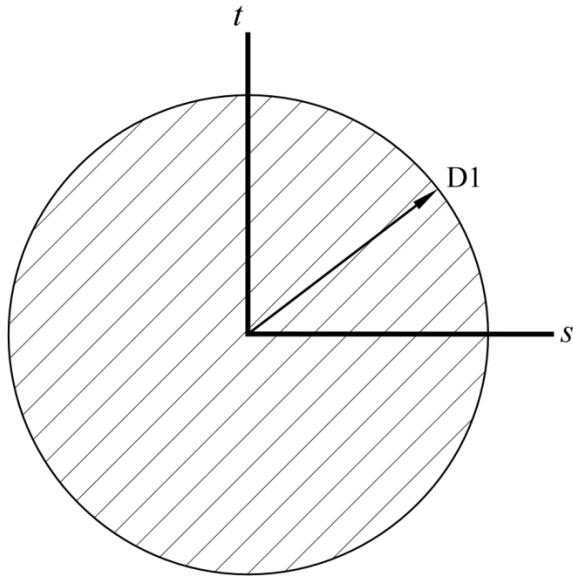
Type 2: Channel





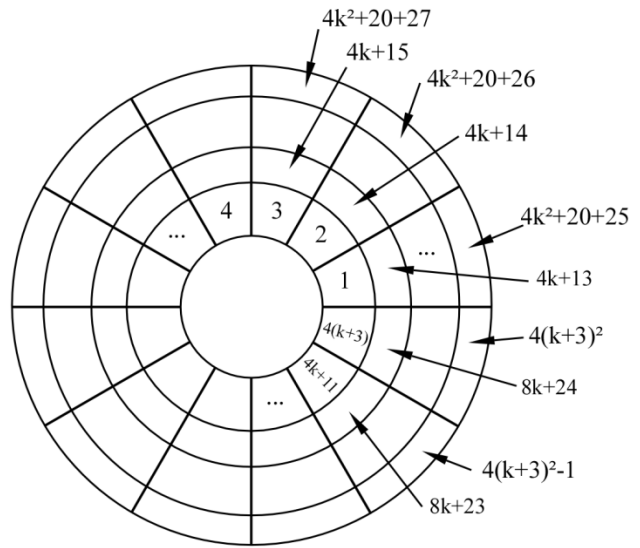
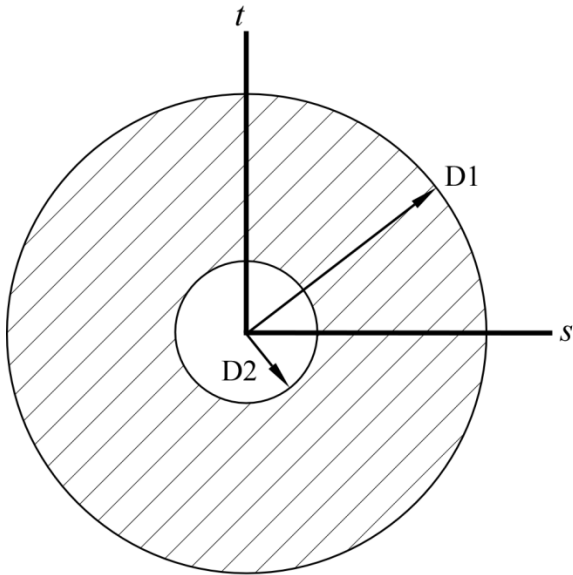


Type 7: Trapezoidal



# of sectors =  $4(k+3)$   
 # of concentric circles =  $k+3$   
 Total # of areas =  $4(k+3)^2$

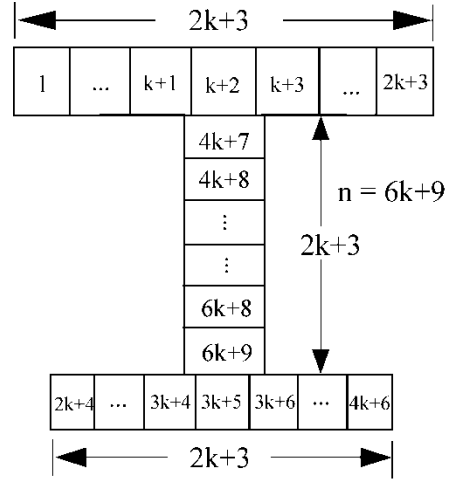
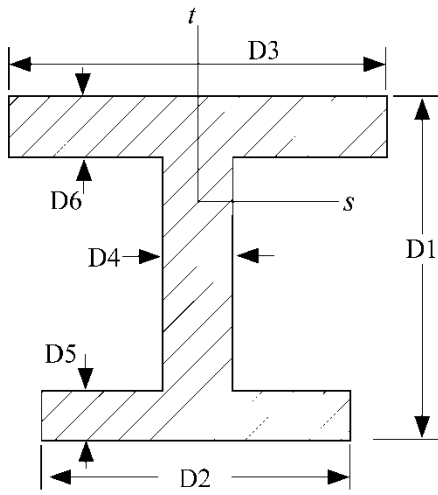
Type 8: Circular



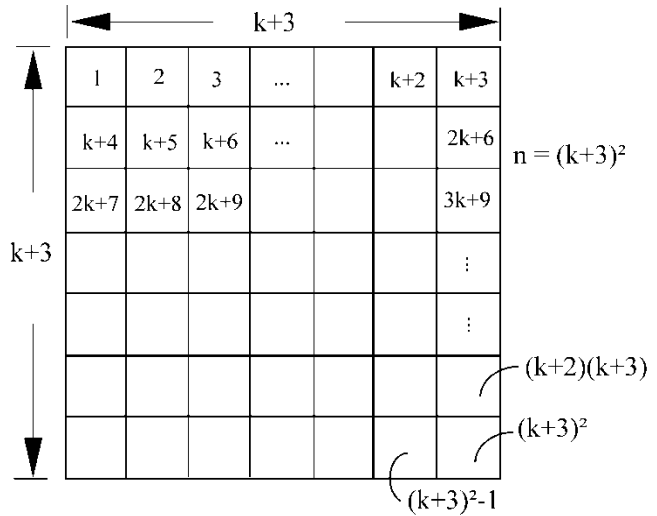
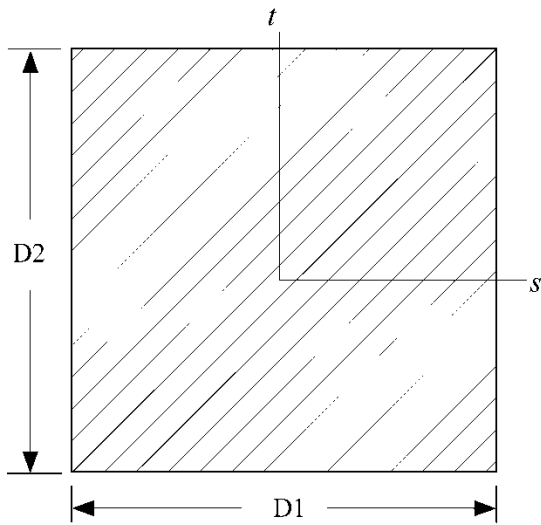
# of sectors =  $4(k+3)$   
 # of concentric circles =  $k+3$   
 Total # of areas =  $4(k+3)^2$

Type 9: Tubular

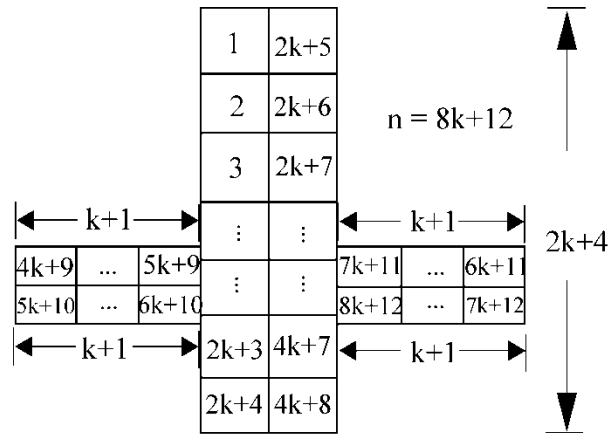
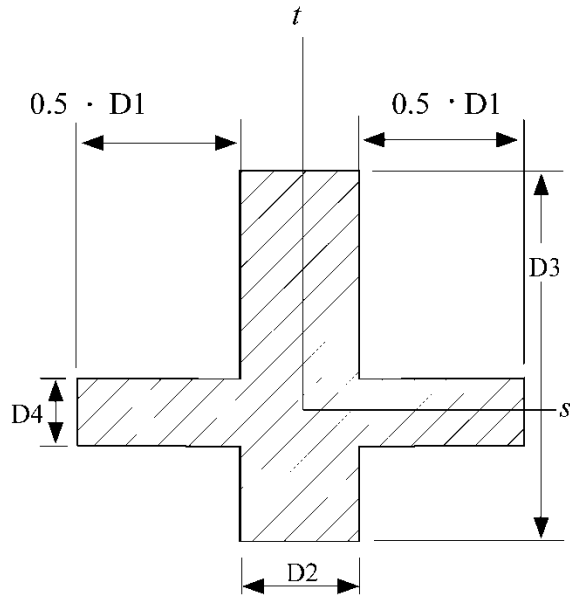




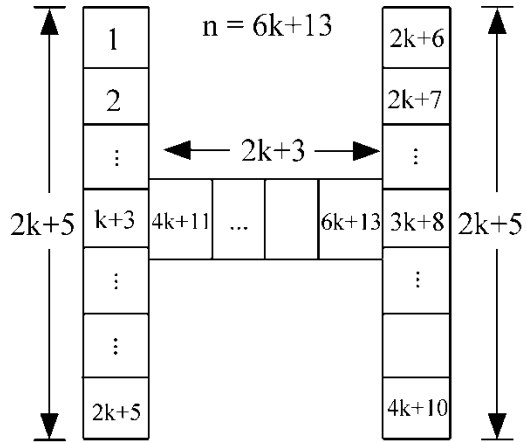
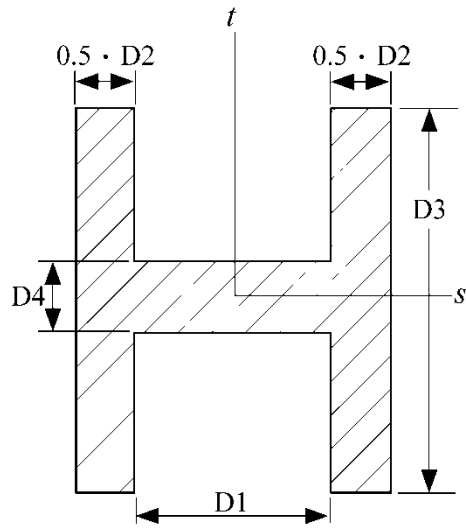
Type 10: I-shape 1



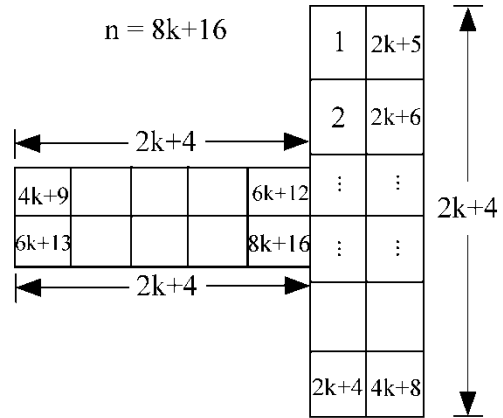
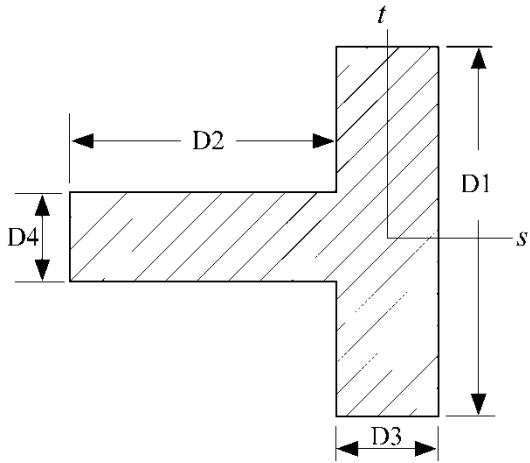
Type 11: Solid Box



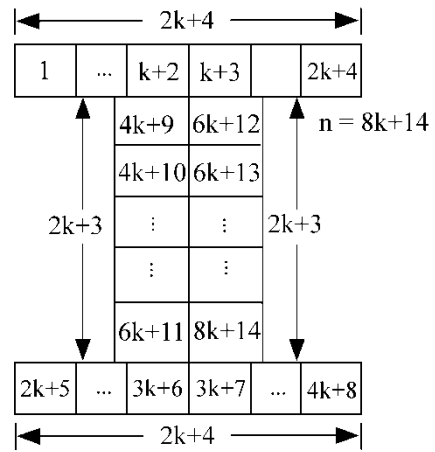
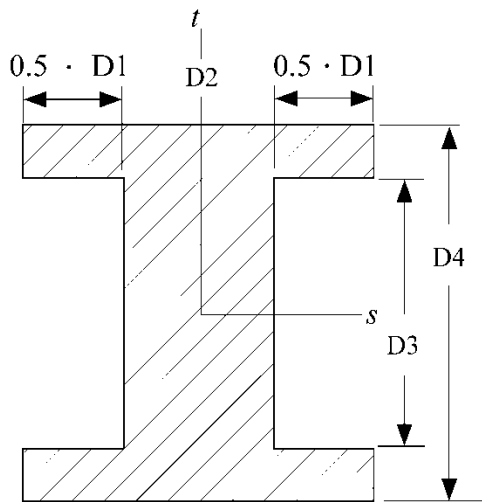
Type 12: Cross



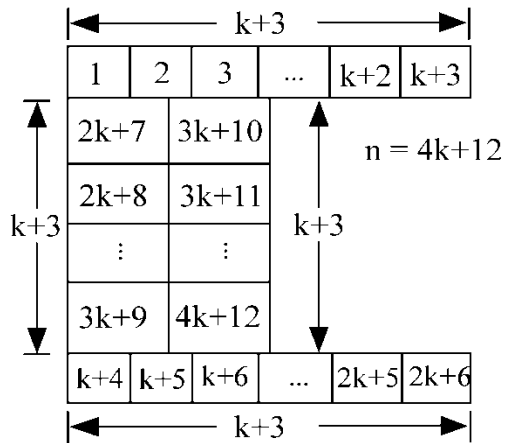
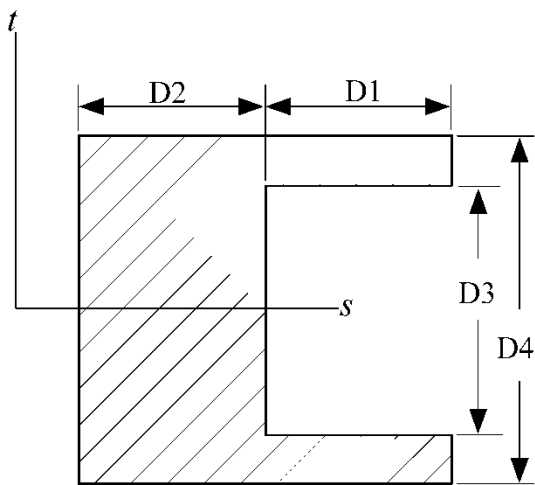
Type 13: H-shape



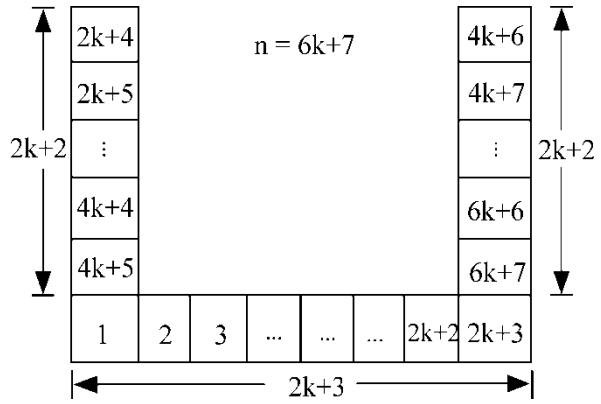
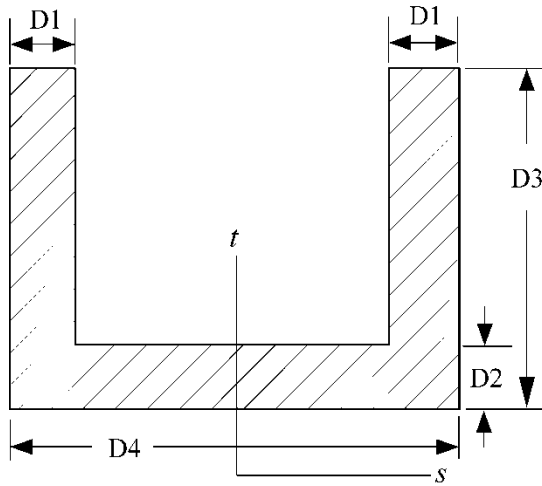
Type 14: T-shape1



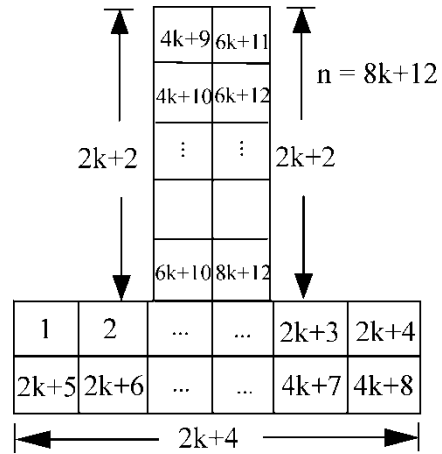
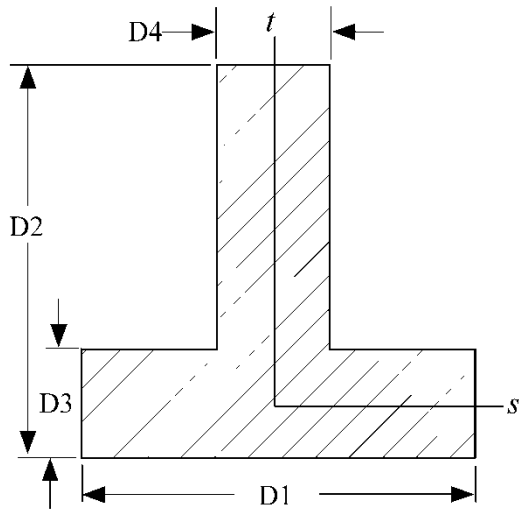
Type 15: I-shape2



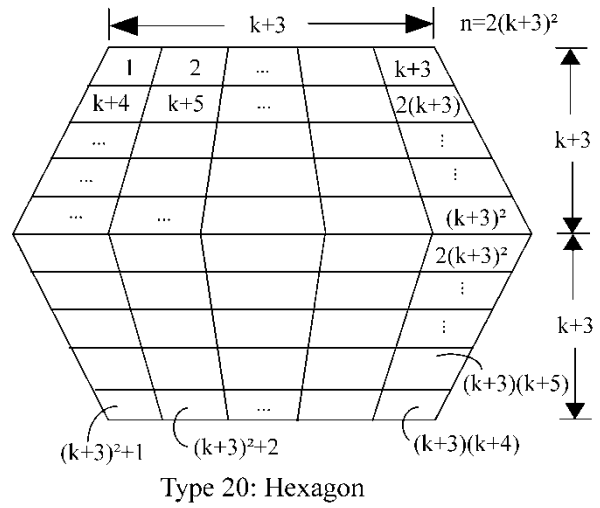
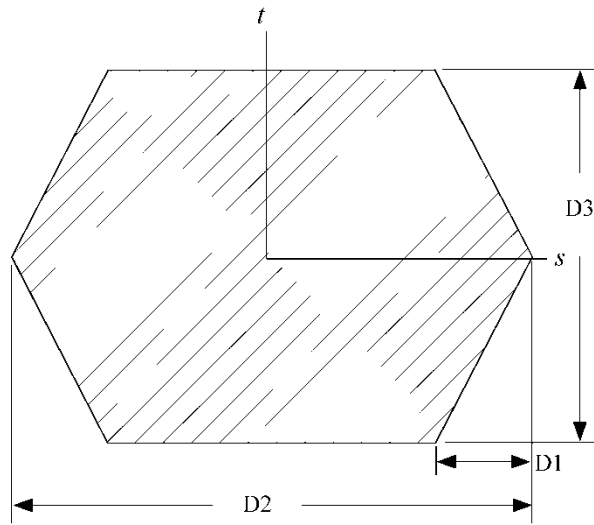
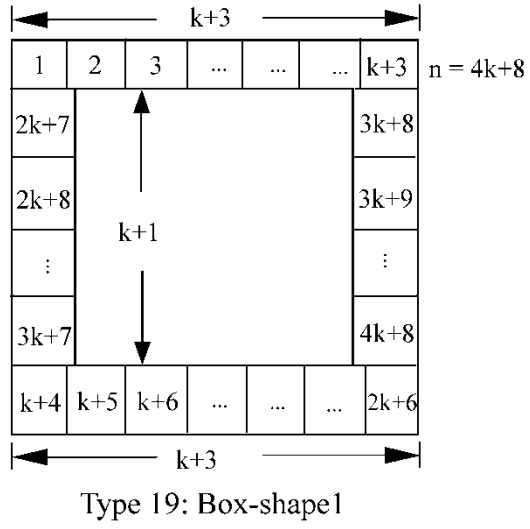
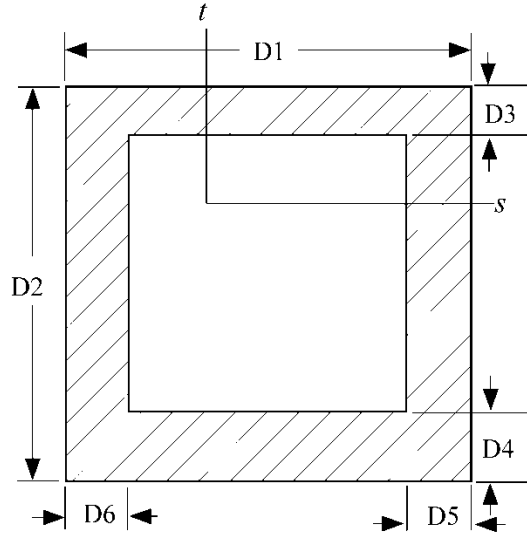
Type 16: Channel1

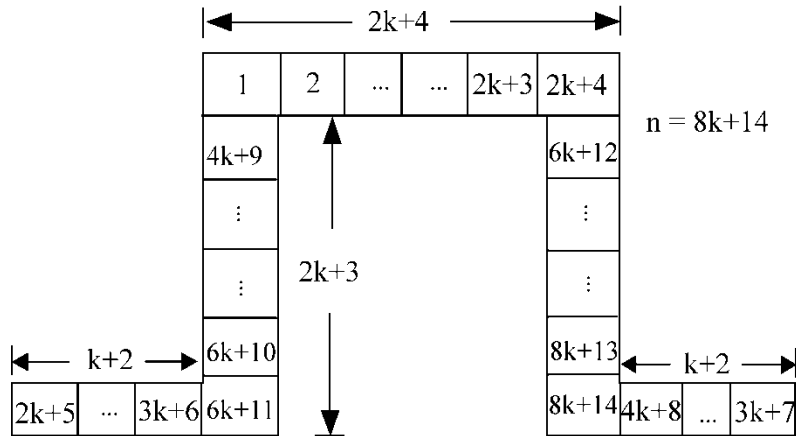
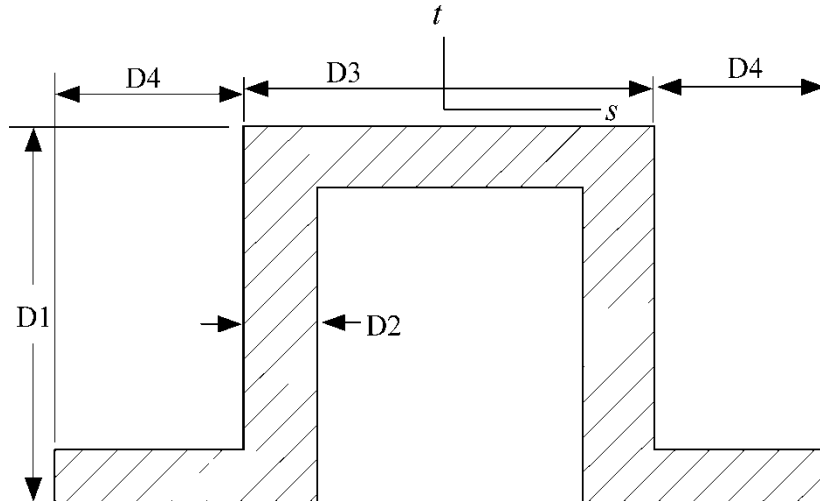


Type 17: Channel2



Type 18: T-shape2





Type 21: Hat-shape

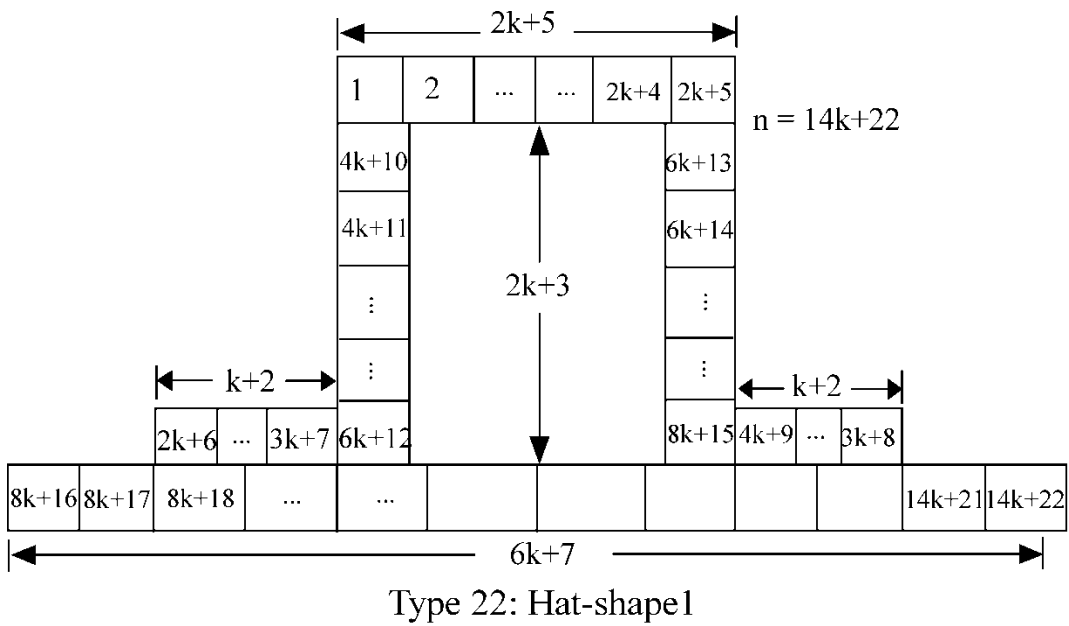
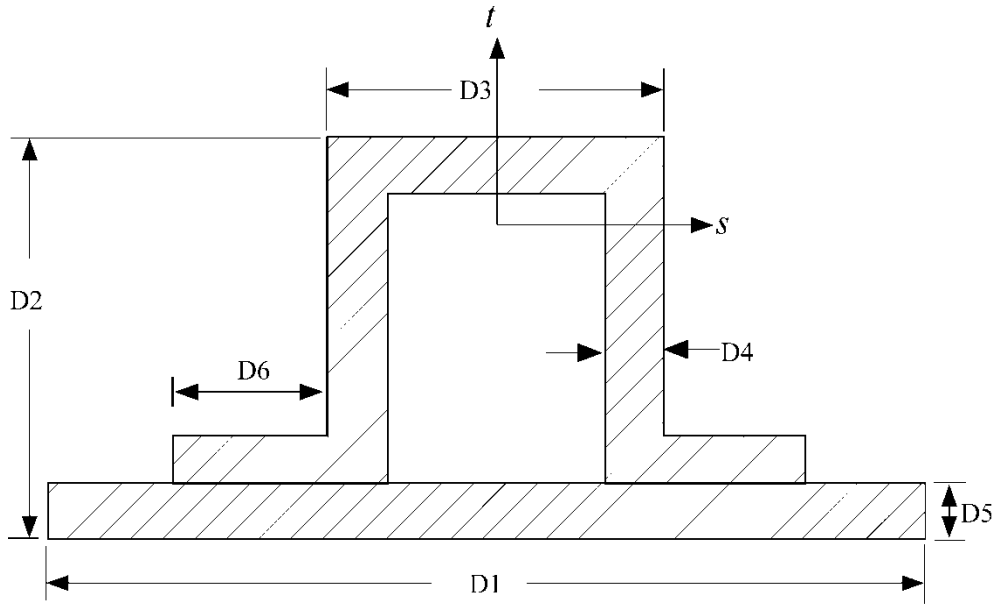


Figure 22.3. Standard beam cross sections.

# \*INTEGRATION

# \*INTEGRATION\_SHELL

## \*INTEGRATION\_SHELL

Purpose: Define user defined through the thickness integration rules for the shell element. This option applies to three dimensional shell elements with three or four nodes (ELEMENT\_SHELL types 1-11 and 16) and to the eight node thick shell (ELEMENT\_TSHELL).

Card 1            1            2            3            4            5            6            7            8

Variable	IRID	NIP	ESOP	FAILOPT				
Type	I	I	I	I				

**Define NIP cards below if ESOP = 0.**

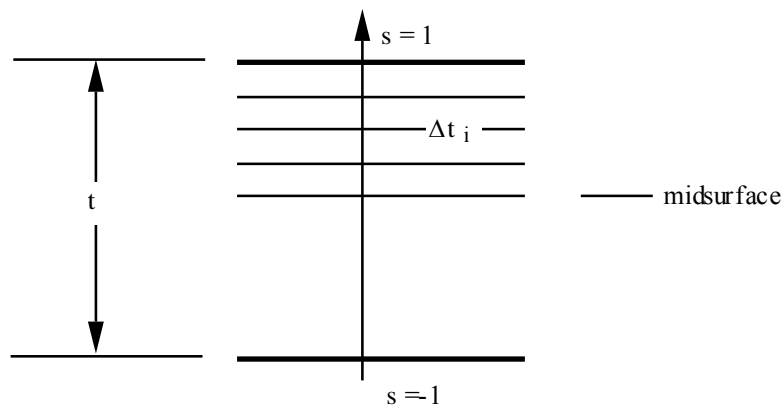
Card            1            2            3            4            5            6            7            8

Variable	S	WF	PID					
Type	F	F	I					

<u>VARIABLE</u>	<u>DESCRIPTION</u>
IRID	Integration rule ID (IRID refers to IRID on *SECTION_SHELL card).
NIP	Number of integration points
ESOP	Equal spacing of integration points option: EQ.0: integration points are defined below, EQ.1: integration points are equally spaced through thickness such that the shell is subdivided into NIP layers of equal thickness.
FAILOPT	Treatment of failure when mixing different constitutive types, which do and do not include failure models, through the shell thickness. For example, consider the case where a linear viscoelastic material model, which does not have a failure option, is mixed with a composite model, which does have a failure option. Note: If the failure option includes failure based on the time step size of the element, element deletion will occur regardless of the value of FAILOPT. EQ.0: Element is deleted when the layers which include failure, fail. EQ.1: Element failure cannot occur since some layers do not have a failure option.



VARIABLE	DESCRIPTION
S	Coordinate of integration point in range -1 to 1.
WF	Weighting factor. This is typically the thickness associated with the integration point divided by actual shell thickness, i.e., the weighting factor for the $i$ th integration point = $\frac{\Delta t_i}{t}$ as seen in Figure 22.4.
PID	Optional part ID if different from the PID specified on the element card. The average mass density for the shell element is based on a weighted average of the density of each layer that is used through the thickness. When modifying the constitutive constants through the thickness, it is often necessary to defined unique part IDs without elements that are referenced only by the user integration rule. These additional part IDs only provide a density and constitutive constants with local material axes (if used) and orientation angles taken from the PID referenced on the element card. In defining a PID for an integration point, it is okay to reference a solid element PID. The material type through the thickness can vary.



**Figure 22.4.** In the user defined shell integration rule the ordering of the integration points is arbitrary.



# **\*INTERFACE**

Interface definitions may be used to define surfaces, nodal lines, and nodal points for which the displacement and velocity time histories are saved at some user specified frequency. This data may then be used in subsequent analyses as an interface ID in the `*INTERFACE_LINKING_DISCRETE_NODE` as master nodes, in `*INTERFACE_LINKING_SEGMENT` as master segments and in `*INTERFACE_LINKING_EDGE` as the master edge for a series of nodes. This capability is especially useful for studying the detailed response of a small member in a large structure. For the first analysis, the member of interest need only be discretized sufficiently that the displacements and velocities on its boundaries are reasonably accurate. After the first analysis is completed, the member can be finely discretized in the region bounded by the interfaces. Finally, the second analysis is performed to obtain highly detailed information in the local region of interest. When beginning the first analysis, specify a name for the interface segment file using the `Z=`parameter on the LS-DYNA execution line. When starting the second analysis, the name of the interface segment file created in the first run should be specified using the `L=`parameter on the LS-DYNA command line. Following the above procedure, multiple levels of sub-modeling are easily accommodated. The interface file may contain a multitude of interface definitions so that a single run of a full model can provide enough interface data for many component analyses. The interface feature represents a powerful extension of LS-DYNA's analysis capabilities. The keyword cards for this purpose are:

- \*INTERFACE\_COMPENSATION\_NEW**
- \*INTERFACE\_COMPONENT\_OPTION**
- \*INTERFACE\_JOY**
- \*INTERFACE\_LINKING\_DISCRETE\_NODE\_OPTION**
- \*INTERFACE\_LINKING\_EDGE**
- \*INTERFACE\_LINKING\_SEGMENT**
- \*INTERFACE\_SPRINGBACK\_OPTION1\_OPTION2**

Interface definitions may also be employed to define soil-structure interfaces in earthquake analysis involving non-linear soil-structure interaction where the structure may be non-linear but the soil outside the soil-structure interface is assumed to be linear. Free-field earthquake ground motions are required only at the soil-structure interface for such analysis. The keyword cards for this purpose are:

- \*INTERFACE\_SSI**
- \*INTERFACE\_SSI\_AUX**

# **\*INTERFACE**

---

**\*INTERFACE\_SSI\_AUX\_EMBEDDED**

**\*INTERFACE\_SSI\_STATIC**

**\*INTERFACE\_COMPENSATION\_NEW\_{OPTION}**

Available options include:

**<BLANK>**

**ACCELATOR**

**MULTI\_STEPS**

Purpose: These features are developed to compensate springback in stamping tools. The capabilities of the features include: 1) to calculate the deviation of the part from its intended design of the stamped part, and automatically compensate the tool to minimize the deviation; 2) to map the existing trimming curve to the modified tool; and (3) to automatically detect the undercut problem.

This compensation algorithm is a nonlinear iterative method. If one iteration is not enough to bring down the part deviation caused by to springback to less than the acceptable tolerance, it is always advised to use more iterations. Usually, it is found that 2~4 iterations are needed for most of the cases. In addition, this method provides a scale factor, which allows the user to decide the ratio of shape deviation the part is compensated.

The option **ACCELATOR** speeds up the convergence rate in reducing the part deviation to design tolerance thus reducing the number of iterations. This option also allows for a much simpler user interface.

The option **MULTI\_STEPS** allows for tooling compensation of the next die process, based on target blank shape, compensated blank shape for the next step, and current tools. This feature is useful in line die process/tooling compensation.

Limitation of the current method involves deficiency in eliminating the undercut problem.

All the target and current tool geometry must be included by using the keyword: **\*INCLUDE\_COMPENSATION\_{OPTION}**.

**Card 1 for options <BLANK> and MULTI-STEPS:**

Card 1            1            2            3            4            5            6            7            8

Variable	METHOD	SL	SF	ELREF	PSIDm	UNDC	ANGLE	NLINEAR
Type	I	F	F	I	F	F	F	I
Default	6	5.0	0.75	1	none	none	0.0	1

**Card 1 for option ACCELATOR:**

Card 1            1            2            3            4            5            6            7            8

Variable	ISTEPS	TOLX	TOLY	TOLZ	OPTION			
Type	I	F	F	F	I			
Default	0	0.5	0.5	0.5	1			

**VARIABLE****DESCRIPTION****METHOD**

There are several extrapolation methods. See **Remarks 1**.

**SL**

The smooth level parameter controls the smoothness of the modified surfaces. A large value makes the surface smoother. The commonly used value is between 5 and 10. If springback is large, the transition region is expected to be large. However, by using a smaller value of SL, the region of transition can be reduced.

**SF**

Shape compensation scale factor. The value scales the springback amount of the blank and the scaled amount is used to compensate the tooling.

GT.0: compensate in the opposite direction of the springback;

LT.0: compensate in the punch moving direction (for undercut).

This scale factor scales how much of the shape deviation is compensated. For example, if 10 mm springback is predicted, and the scale factor is chosen as 0.75, then the compensation in the opposite direction will only be 7.5 mm.

Through many parameter studies, it is found that the best scale factor is case dependent. For some cases, a scale factor of 0.75 is best; while for others, larger values are better. Sometimes, the best value can be larger than 1.1.

Since it is impossible to choose the best value for each application it is suggested that for a new application, the initial trial is 0.75. If the springback cannot be effectively compensated, more iterations must be used to compensate the remaining shape deviation.

For channel with twisting, the scale factor is more important. It was found that a small change of the tool shape might change the twisting mode. If this occurs, using a small value (<0.5) is suggested.

VARIABLE	DESCRIPTION
ELREF	<p>Element refinement option:            EQ.1: special element refinement is used with the tool elements (default);            EQ.2: special element refinement is turned off.</p>
PSIDm	<p>Define the Part set ID for master parts. It is important to properly choose the parts for the master side. Usually, only one side (master side) of the tool will be chosen as the master side, and the modification of the other side (slave side) depends solely on the change, which occurs in the master side. In this way, the two sides are coupled and a constant gap between the two sides is maintained. If both sides are chosen as master side, the gap between the two sides might change and the gap might become inhomogeneous.</p> <p>The choice of Master side will have effect on the final result for method 7 for three-piece draw. At this time, when the punch and binder are chosen as the master side, the binder region will not be changed. Otherwise, when the die is chosen as Master side the binder will be changed, since the changes extend to the edges of the Master tool.</p>
UNDC	<p>Tool undercut treatment option:            EQ.0: no check (default);            EQ.1: check and fix undercut.</p>
ANGLE	<p>An angle defining the undercut.</p>
NLINEAR	<p>Activate nonlinear extrapolation.</p>
ISTEPS	<p>Steps in accelerated compensation procedure. See <b>Remarks</b>.</p>
TOLX	<p>Part deviation tolerance between current blank and target blank shape in global X-direction.</p>
TOLY	<p>Part deviation tolerance between current blank and target blank shape in global Y-direction.</p>
TOLZ	<p>Part deviation tolerance between current blank and target blank shape in global Z-direction.</p>
OPTION	<p>Compensation acceleration method. Currently only method 1 is available.</p>

**Remarks:**

1. After trimming, only a limited part of the tool has direct relationship with the springback of the blank part. The modification of the rigid tool outside the trimming curve has to rely on extrapolation. However, extrapolating is an unstable process, it is easy to have a non-smooth surface. To resolve this problem, seven smoothing algorithms have been proposed. The frequently used methods are: 7, 3, 6 and 8. The others are used occasionally.

**Method 7:** If the punch is chosen as the master side, the binder will not be changed. The only change occurring involves inside punch opening. Under this option, the smoothing factor has little effect. The smoothness of the modified tool depends on the magnitude of the springback and the size of the addendum region.

**Advantages:** The binder will not be changed.

**Disadvantages:** The change will be limited inside the addendum region, and the modified surface may not be smooth if the springback magnitude is large and the transition is small. This is a non-linear method, and the iterative method is used.

**Method 6:** The smoothness and the transition region of the modified surface will depend on the springback magnitude and the smoothing factor. If the springback magnitude is large, the transition region will be increased automatically. On the other hand, the transition region will be smaller if the springback magnitude is small. At the same time, a larger smoothing factor will result in a smaller transition region.

**Advantages:** The smoothness of the modified surfaces can be controlled. This is a non-linear method and the iterative method is used.

**Disadvantages:** It is impossible to limit the transition region, and the binder surface could change if the springback is large.

**Method 3:** Similar to Method 6, however, it is a linear method and no iteration is necessary. The other options may be removed in the future; therefore they will not be discussed.

**Method 8:** This is an improvement over Method 6, and can account for addendum and binder changes. Usually the upper tooling including addendum and binder (in an air draw) are included in the PSIDm definition.

**Method -8:** This method is a modification of Method 8, and is used for trim die nesting (from the drawn panel shape).

**Method used to Prevent Undercut**

When the wall is steep, it is very possible that undercut will happen. Since undercut is not accepted in real die manufacturing, it is necessary to prevent it from happening.



The code can automatically detect undercut and issue a warning message. In addition, it will save all the element information into a file called blankundercut.tmp so that the user can easily identify which elements may be problematic.

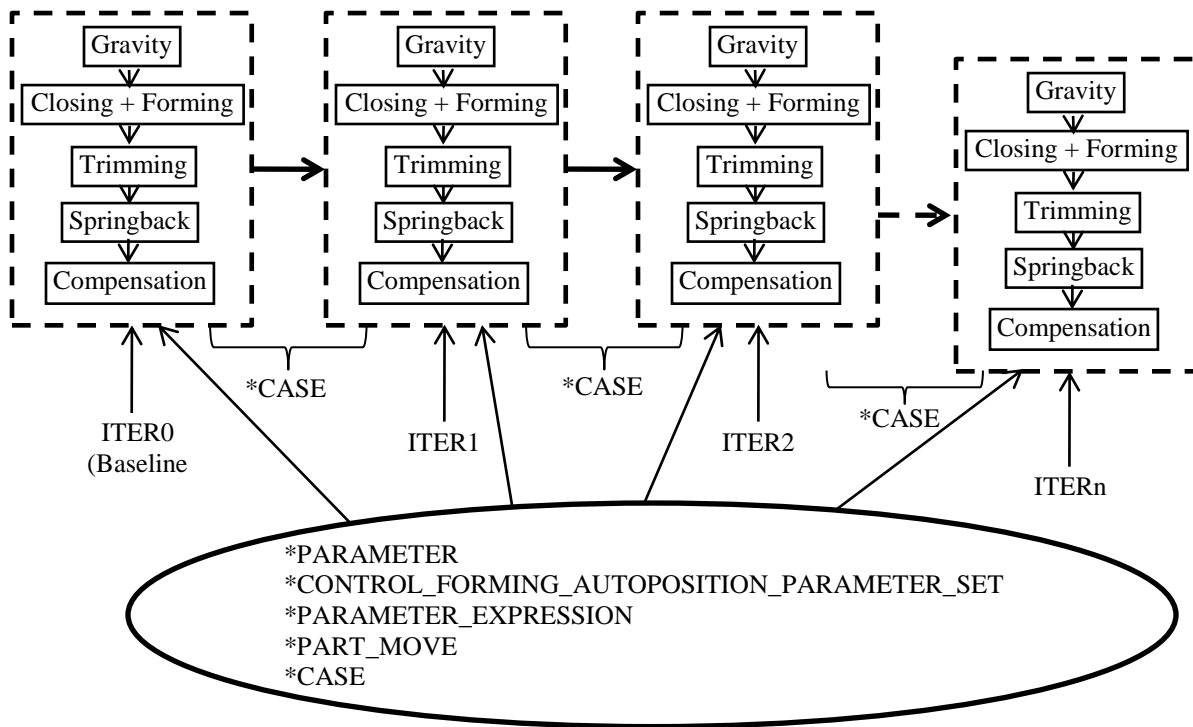
If the undercut is only limited to a few elements, it is possible to fix the problem manually. The code provides one more option to handle undercut problem, i.e. to compensate the springback only in the punch moving direction (by using a negative scale factor). Although it is known that this method is not the best method to handle undercut problems, better solutions are being studied.

2. In a complete keyword input example for tool springback compensation below, the keyword file blank0.k includes node and element information of the blank shape before springback (after forming and trimming) with adaptive constraints, if exist. The keyword file spbk.k includes node and element information of the blank after springback, with adaptive constraints, if exist. In an iterative springback compensation loop, one iteration may include draw, trim, springback and compensation processes. Files blank0.k and spbk.k may be based on the original die design (ITER0), or based on the n<sup>th</sup> iteration (ITERn) on an intermediate compensated die design. The keyword file reference0.k is the blank shape before springback in the ITER0. This file is the same as blank0.k and should not change from iteration to iteration. The file reference1.k is the same as blank0.k for the ITER0. For ITER1 reference1.k should be assigned as a file called disp.tmp generated from a compensation run in the ITER0, so on and so forth. The file tools.k is the mesh information of all stamping tools and they must be in home position. Compensated tools will be in the file rigid.new and the original constant gap is maintained among the tools. In the baseline run of the ITER0, a keyword file called geocur.trm is used for keyword \*INCLUDE\_COMPENSATION\_TRIM\_CURVE and it is generated during LS-DYNA trimming based on trimming curve input (usually in IGES format) in the trimming simulation. In the compensation run of the ITER1, geocur.trm is used to generate new trim curves called geotrm.new, which conforms to the current compensated tools; and the new mapped trim curves are used for the ensuing ITER2, so on and so forth. The file geotrm.new is also a keyword file with \*DEFINE\_CURVE\_TRIM\_3D. In this example of a three-piece air draw, upper die cavity (including binder) has a part ID 2, which is included in the part set ID 1 and used for variable PSIDm. Method 8 will compensate all the tools included in file tools.k based on compensated shape for the upper cavity.

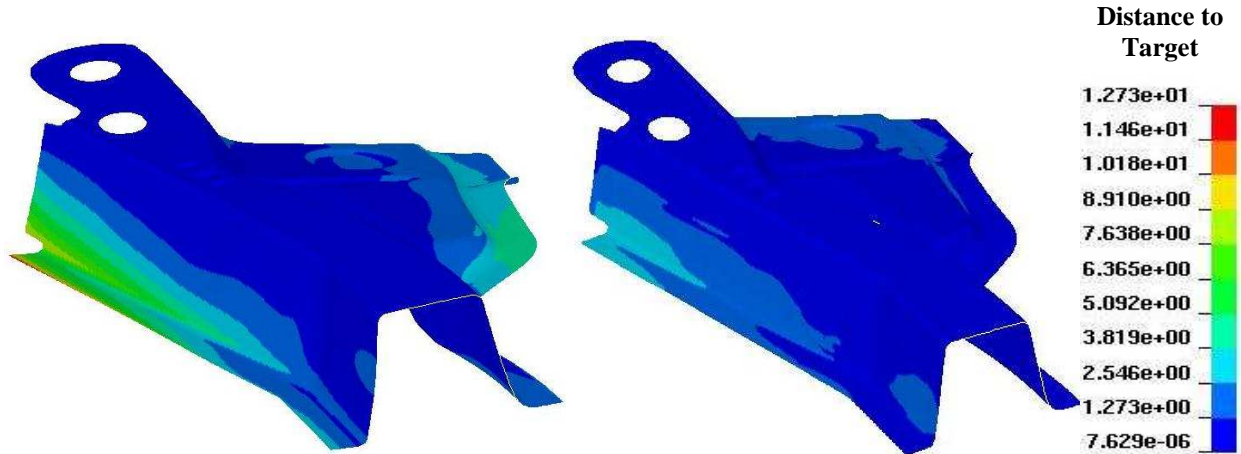
```
*KEYWORD
$-----1-----2-----3-----4-----5-----6-----7-----
*INTERFACE_COMPENSATION_NEW
$ METHOD          SL          SF          ELREF          PSIDm          UNDRCT          ANGLE NLINER
      8          10.000          1.000          0              1              0              0.0          1
*INCLUDE_COMPENSATION_BLANK_BEFORE_SPRINGBACK
blank0.k
*INCLUDE_COMPENSATION_BLANK_AFTER_SPRINGBACK
spbk.k
*INCLUDE_COMPENSATION_DESIRED_BLANK_SHAPE
reference0.k
*INCLUDE_COMPENSATION_COMPENSATED_SHAPE
reference1.k
*INCLUDE_COMPENSATION_CURRENT_TOOLS
tools.k
```

```
*INCLUDE_COMPENSATION_TRIM_CURVE
geocur.trim
*SET_PART_LIST
$   PSID
   1
$   PID
   2
$-----1-----2-----3-----4-----5-----6-----7-----
*END
```

Based on a specific stamping die process, a fully automatic and iterative springback compensation loop is possible and shown in the flow chart below.

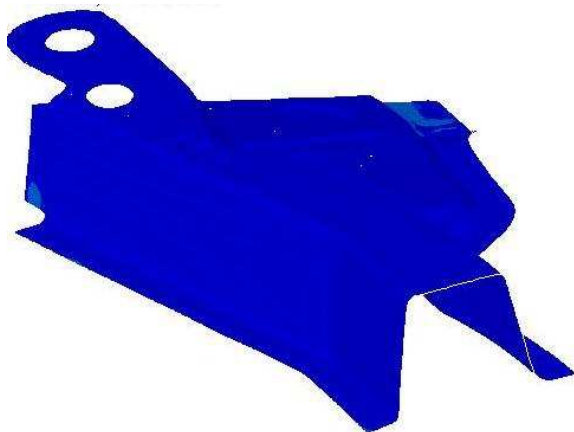


3. In an example shown below, the NUMISHEET'05 cross member is compensated based on the automatic and iteration flow chart. A total of 2 iterations reduced springback from 13mm to less than 1.7 mm. Further iterations will reduce the part deviation down to a specific design target. Typically, 3~4 iterations are needed.

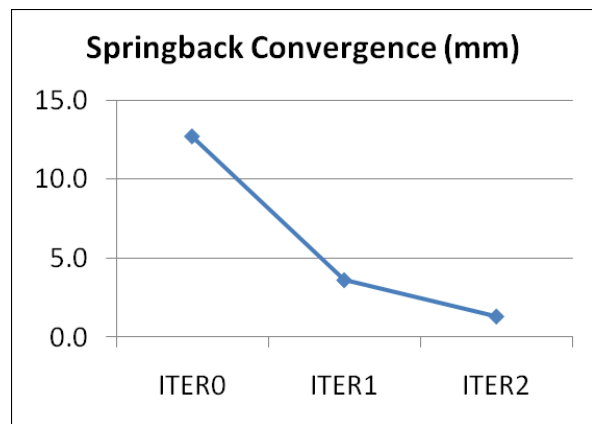


- ITER0
- 4mm ~ 13mm on mating flanges

- ITER1
- Springback reduced to < 3.5mm

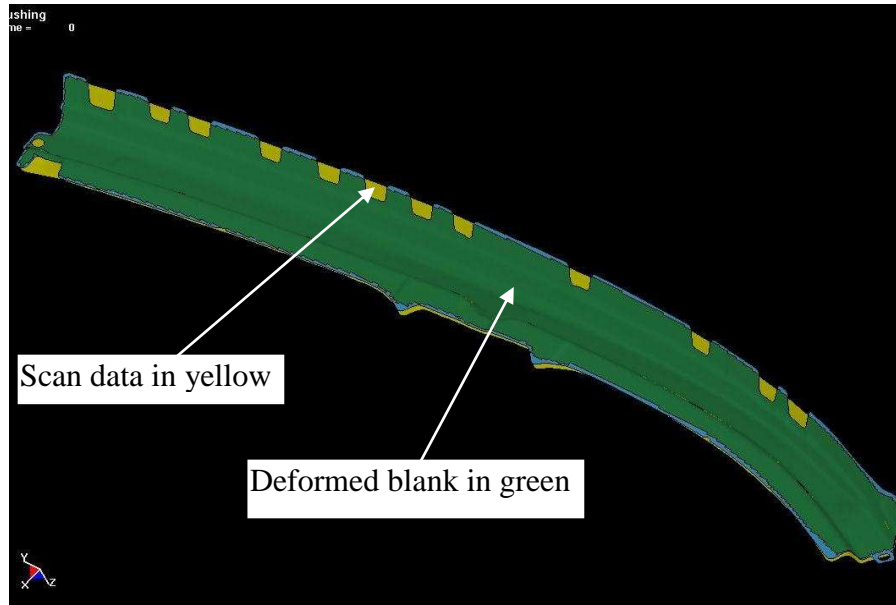


- ITER2
- Springback reduced to < 1.7mm

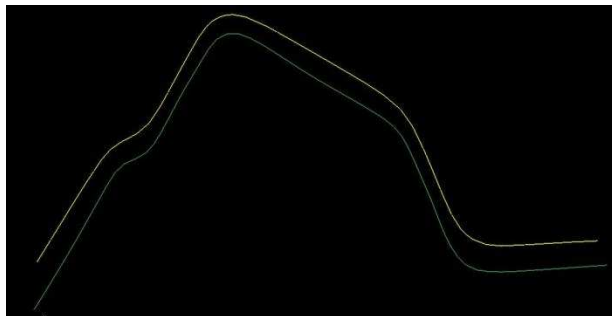


- Compensation convergence history

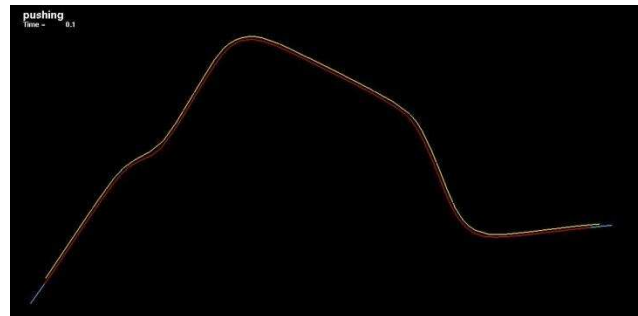
4. The blank shape after springback can also be obtained from the actual shape of the springback panel, if available. For example, in hard tool construction, the trimmed panel can be scanned using white light technology and the panel shape can be output as STL format. The STL format can be easily converted to LS-DYNA keyword format and the trimmed panel can then be used as a rigid tool onto which baseline (ITER0) trimmed panel (deformable) can be “pushed” using element normal pressure, using \*CONTROL\_IMPLICIT\_FORMING type 1. In this scenario, the adaptive refinement is turned off to maintain the one-to-one correspondence of the elements and nodes information. An advantage of this method is that the springback shape used for compensation will be exactly the same as the real panel springback, therefore the best tooling compensation result is expected. An example of such is shown in figures below.



A trimmed panel “pushed” onto the scan data (rigid body)



Beginning of the “Push”

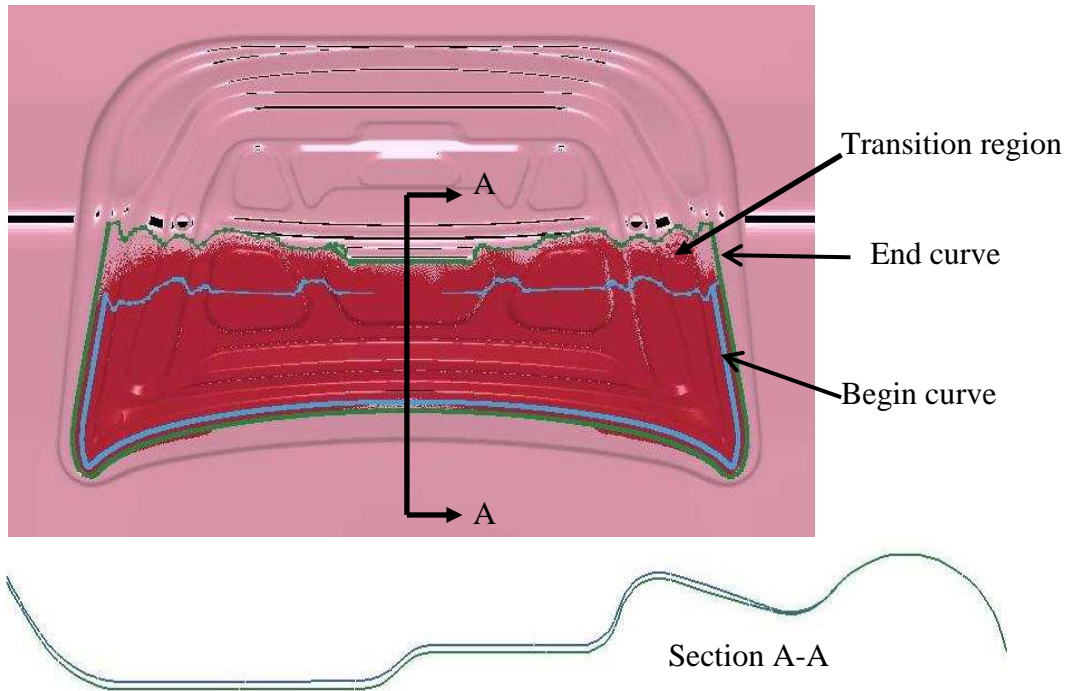


End of the “pushed”

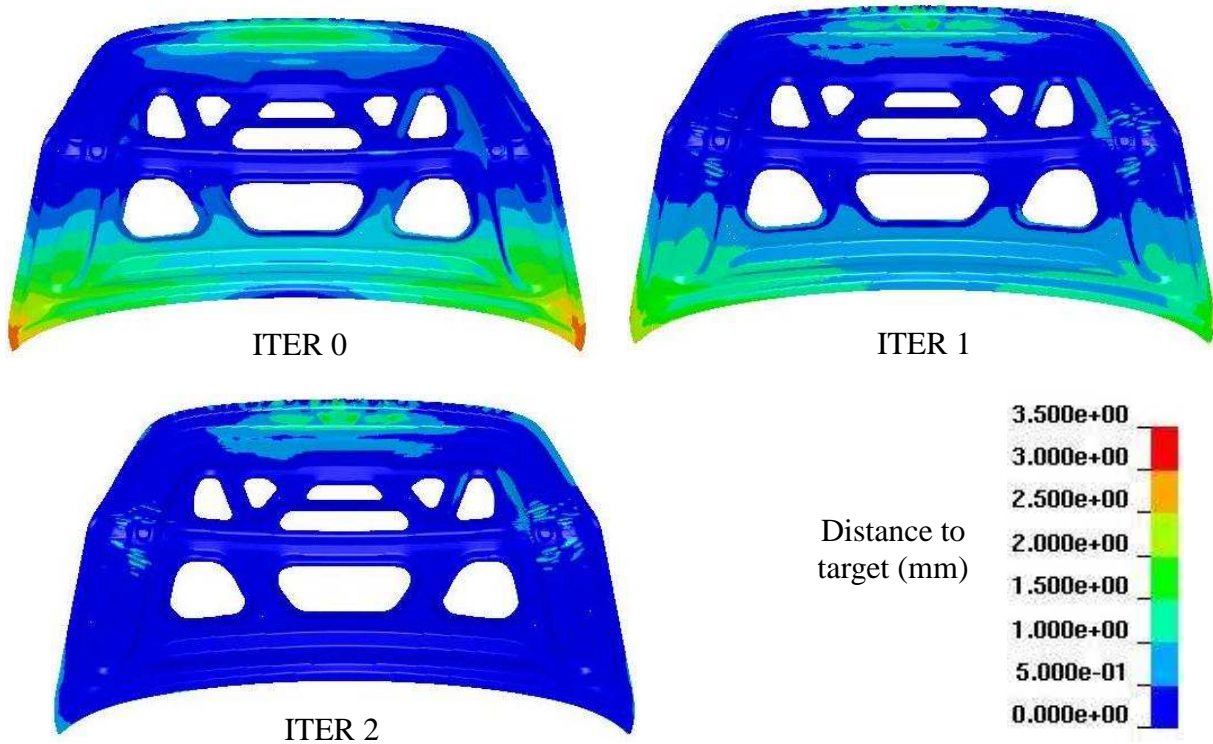
- 5. Compensation of a localized tooling region is possible, with the keyword `*INCLUDE_COMPENSATION_CURVE`, by simply adding the following lines into the above example inputs:

```
*INCLUDE_COMPENSATION_CURVE  
curves.k
```

The file `curves.k` defines the two enclosed “begin” and “end” curves using `*DEFINE_CURVE_COMPENSATION_BEGIN`, and `*DEFINE_CURVE_COMPENSATION_END`. More explanations can be found in these two keyword manual pages. In an example shown below, the NUMISHEET’05 decklid inner is being compensated locally in the horizontal deck off the backlite. Tangency of the compensated tool is maintained at the End Curve as shown in section A-A. Part tolerance is achieved in two iterations.



Two curves defining a localized compensation zone of the upper half of the deck lid



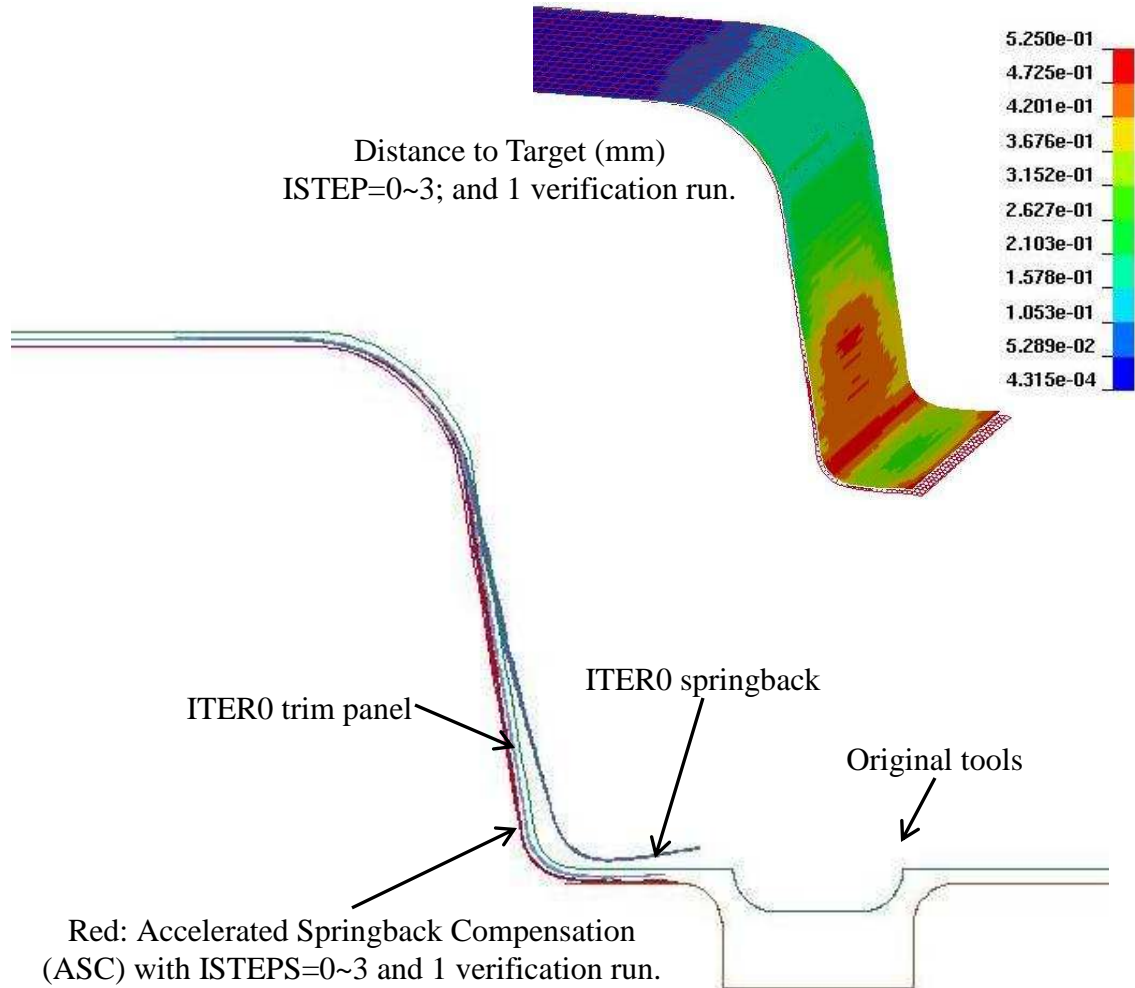
Iterative compensation for a localized region

6. The option ACCELATOR is used in conjunction with \*INCLUDE\_COMPENSATION, with options ORIGINAL\_DYNAIN and SPRINGBACK\_INPUT to compensate springback with a faster convergence rate and a simplified user interface. In a complete example inputs provided below, an usual springback input file spbk.dyn, and a trimmed panel, with file name case20trimmed.dynain (including all stress and strain tensors), are included with the corresponding keywords. The variable ISTEPS was increased from 0 to 3, representing 3 compensation iterations. ISTEPS=0 represents the baseline springback simulation (ITER0); while ISTEPS=1, 2, 3 represent the compensation iterations. This feature requires the user to change only one variable (ISTEPS), and then submit the same input file to conduct an iterative compensation. Many scratch files, including a file named acceltmp.tmp, will be generated and updated in the same running directory and is used for each ISTEPS run. A file, compensation.info, is also generated and updated after each ISTEPS run, contains iteration information, maximum deviations in X, Y, and Z directions. When the maximum deviation has reached within the tolerances specified with TOLX, TOLY, and TOLZ, a message appears in the file proclaiming the compensation iterations has converged, along with a message of instructions for the next step. Essentially, a file spbk.new will be generated in the same directory and needs to be used for \*INCLUDE\_COMPENSATION\_BLANK\_AFTER\_SPRINGBACK, and the scale factor for the tool compensation must be set to one. After the compensation, a verification run may be needed.

Currently, mesh coarsening and checking are not supported in accelerated mode. Also, inclusion of dynain file from the previous die process in the spbk.dyn is not necessary.

```
*KEYWORD
*INTERFACE_COMPENSATION_NEW_ACCELATOR
$  ISTEPS      TOLX      TOLY      TOLZ      OPTION
      3      0.20      0.20      0.2      1
*INCLUDE_COMPENSATION_ORIGINAL_DYNAIN
./case20trimmed.dynain
*INCLUDE_COMPENSATION_SPRINGBACK_INPUT
./spbk.dyn
*END
```

An example of such is shown below, which converged in three iterations; while four iterations were needed for the non-accelerated compensation.



- The option `MULTI_STEPS` is used together with `*INCLUDE_COMPENSATION_COMPENSATED_SHAPE_NEXT_STEP` to enable compensation of tools for the next die process. In a complete input file example below, in addition to the target blank shape (reference0.tmp) and current tool (rigid.tmp) from the 1<sup>st</sup> die process step, the file disp.tmp is from the compensation in the 2<sup>nd</sup> die process step. For example, a flanging die compensation can be a 2<sup>nd</sup> die process step, preceded by a redraw die process as the 1<sup>st</sup> die process step.

```
*KEYWORD
*INTERFACE_COMPENSATION_NEW_MULTI_STEPS
$-----1-----2-----3-----4-----5-----6-----7-----8
$  METHOD      SL      SF      ELREF      PSID      UNDRCT      ANGLE      NLINEAR
      8      6.000      1.00      1      1      0      0      1
*INCLUDE_COMPENSATION_DESIRED_BLANK_SHAPE
reference0.tmp
*INCLUDE_COMPENSATION_COMPENSATED_SHAPE_NEXT_STEP
disp.tmp
*INCLUDE_COMPENSATION_CURRENT_TOOLS
rigid.tmp
```

```

*SET_PART_LIST
$   PSID
    1
$   PID
    2
*END

```

8. Trim die can be compensated using the drawn panel springback shape when Method is set to -8. In a complete keyword input deck below, also referring to the figure that follows, draw panel (state1.k) is taken as the blank before springback, and, draw panel springback shape (state2.k) is taken as the blank after springback. Tool shape for the draw process (drawtool.k) is used as the current tool. After the simulation, LS-DYNA will create a compensated tool named rigid.new, which can be used for the trim die shape.

```

*KEYWORD
$-----1-----2-----3-----4-----5-----6-----7-----8
*INTERFACE_COMPENSATION_NEW
$   METHOD      SL      SF      ELREF      PSID      UNDRCT      ANGLE      NLINEAR
    -8      10.000      1.000      2      1      0      0.0      1
*INCLUDE_COMPENSATION_BLANK_BEFORE_SPRINGBACK
state1.k
*INCLUDE_COMPENSATION_BLANK_AFTER_SPRINGBACK
state2.k
*INCLUDE_COMPENSATION_DESIRED_BLANK_SHAPE
ref0.tmp
*INCLUDE_COMPENSATION_COMPENSATED_SHAPE
ref1.tmp
*INCLUDE_COMPENSATION_CURRENT_TOOLS
drawtool.k
*INCLUDE_COMPENSATION_TRIM_CURVE
originaltrim.k
*SET_PART_LIST
$   PSID
    1
$   PID
    3
$-----1-----2-----3-----4-----5-----6-----7-----8
*END

```



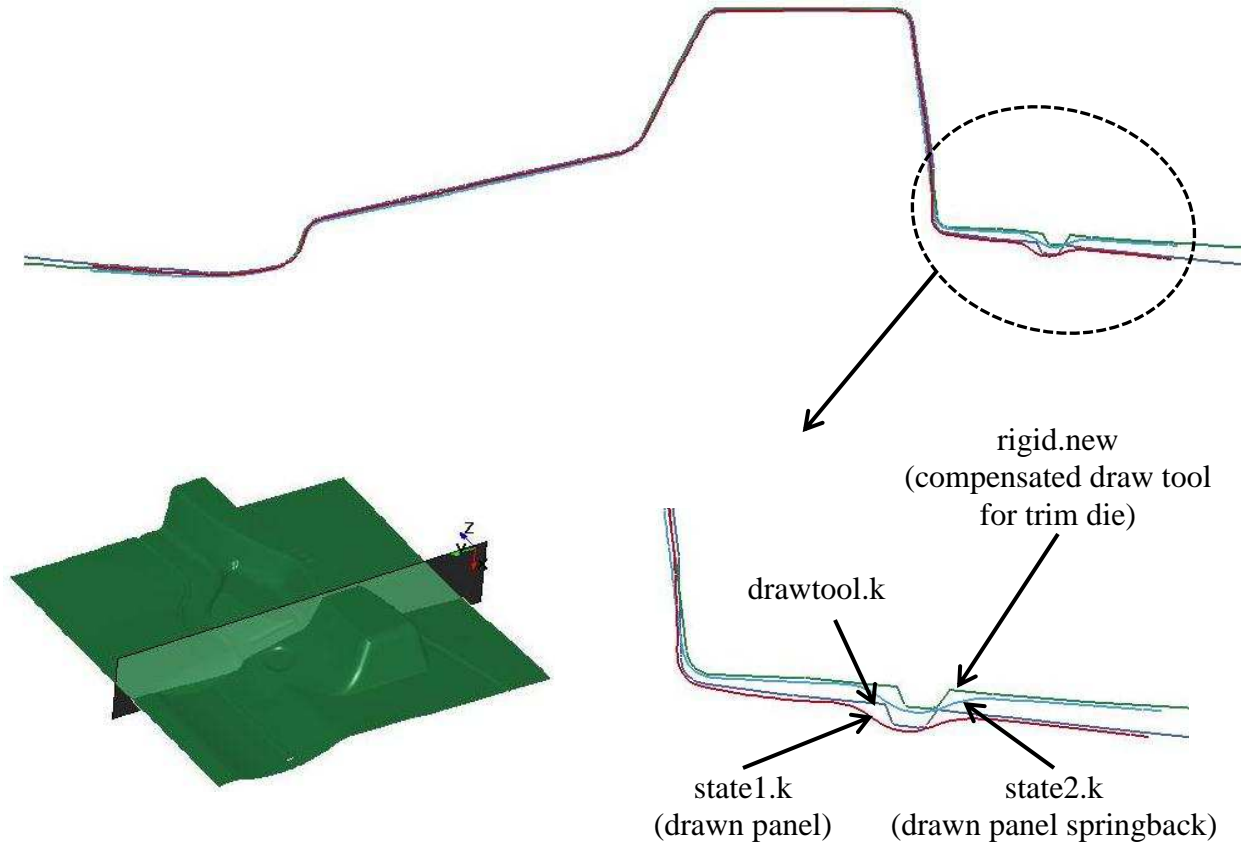


Illustration – trim die nesting with drawn panel shape

9. The manual pages related to `*INCLUDE_COMPENSATION_{OPTION}` can be further referenced for details.
10. The option of `ACCELATOR` is available in LS-DYNA R5 Revision 61264 and later releases and `MULTI_STEPS` is available in R5 Revision 61406 and later releases.

**\*INTERFACE\_COMPONENT\_FILE**

Purpose: Allow for the specification of the file where the component interface data should be written, and the optional use of a new binary format for that data.

**Card 1 is required**

Card 1	A80
Variable	Filename
Default	None

**Card 2 is optional**

Card 2	1	2	3	4	5	6	7	8
Variable	Format							
Type	I							
Default	2							

**VARIABLE****DESCRIPTION**

FNAME	Name of the file where the component data will be written
FORMAT	File format to use: EQ 1: Use old binary file format EQ 2: Use new LSDA file format

**Remarks:**

If Z= is used on the command line, this card will be ignored. If this card is in effect, the new LSDA file format is the default format to be used. The new format has certain advantages, and one possible drawback:

- It allows for the use of the \_TITLE modifier on all \*INTERFACE\_COMPONENT inputs, so that subsequent \*INTERFACE\_LINKING cards can refer to components by a user specified ID.
- It is fully portable between machines with different precision and byte order.

- It maintains the full precision of the coordinate vector. The internal coordinate vector has been in double precision for quite some time, even for single precision executables. The old binary format writes 32 bit data for single precision executables, losing some precision in the process.
- Because of the maintained precision, the new format files will be significantly larger when running in single precision.

Of course, the new file format cannot be used for subsequent analysis with older versions of LS-DYNA, particularly those with a Product ID less than 50845. Executables which can read the new format for \*INTERFACE\_LINKING analysis will automatically detect whether the new or old format is in use.

# \*INTERFACE

# \*INTERFACE\_COMPONENT

\*INTERFACE\_COMPONENT\_OPTION1\_{OPTION2}

Available values for OPTION1 include:

**NODE**

**SEGMENT**

OPTION2 only allows the value:

**TITLE**

Purpose: Define an interface for linking calculations. This card applies to the first analysis for storing interfaces in the file specified by Z=isf1 on the execution command line, or the \*INTERFACE\_COMPONENT\_FILE keyword.. The output interval used to write data to the interface file is controlled by OPIFS on \*CONTROL\_OUTPUT.

This capability allows the definition of interfaces that isolate critical components. A database is created that records the motion of the interfaces. In later calculations the isolated components can be reanalyzed with arbitrarily refined meshes with the motion of their boundaries specified by the database created by this input. The interfaces defined here become the masters in the tied interface options.

Each definition consists of a set of cards that define the interface. Interfaces may consists of a set of four node segments for moving interfaces of solid elements, a line of nodes for treating interfaces of shells, or a single node for treating beam and spring elements.

**Define this card if and only if the \_TITLE option is given**

REQ N	1	2-8
Variable	ID	Title
Type	I	Character
Default	None	None

## VARIABLE

## DESCRIPTION

ID	ID for this interface in the linking file
Title	Title for this interface

Card            1            2            3            4            5            6            7            8

Variable	SID							
Type	I							

**VARIABLE**

**DESCRIPTION**

SID

Set ID, see \*SET\_NODE or \*SET\_SEGMENT.

**Remarks:**

If the old style binary format is used for the linking file (see \*INTERFACE\_COMPONENT\_FILE) then the ID values are ignored and all components are numbered according to their input order, starting from 1.

# **\*INTERFACE**

# **\*INTERFACE\_LINKING\_DISCRETE\_NODE**

## **\*INTERFACE\_LINKING\_DISCRETE\_NODE\_OPTION**

Available options include:

**NODE**

**SET**

Purpose: Define an interface for linking discrete nodes to an interface file. This link applies to all element types. With this option the nodes, if specified by a node set, must be give in the same order as they appear in the interface file. This restriction is removed by the more recent keyword \*INTERFACE\_LINKING\_NODE\_....

Card            1            2            3            4            5            6            7            8

Variable	NID/NSID	IFID						
Type	I	I						

### **VARIABLE**

### **DESCRIPTION**

NID	Node ID or Node set ID to be moved by interface file, see *NODE or *SET_NODE.
IFID	Interface ID in interface file.

**\*INTERFACE\_LINKING\_EDGE****\*INTERFACE****\*INTERFACE\_LINKING\_EDGE**

Purpose: Define an interface for linking a series of nodes in shell structure to an interface file for the second analysis using L=isf2 on the execution command line. This link applies segments on shell elements only.

Card            1            2            3            4            5            6            7            8

Variable	NSID	IFID						
Type	I	I						

**VARIABLE****DESCRIPTION**

NSID	Node set ID to be moved by interface file.
IFID	Interface ID in interface file.

# **\*INTERFACE**

## **\*INTERFACE\_LINKING\_FILE**

### **\*INTERFACE\_LINKING\_FILE**

Purpose: Allow for the specification of the file from which the component interface data should be read.

#### **Card 1 is required**

Card 1	A80
Variable	Filename
Default	None

<u>VARIABLE</u>	<u>DESCRIPTION</u>
FNAME	Name of the file from which the component data will be read

#### **Remarks:**

If L= is used on the command line, this card will be ignored. There is no option to specify the file format, as the file format is automatically detected.



**\*INTERFACE\_LINKING\_NODE\_OPTION**

Available options include:

**NODE**

**SET**

Purpose: Define an interface for linking nodes to an interface file. This link applies to all element types.

Card                    1                    2                    3                    4                    5                    6                    7                    8

Variable	NID/NSID	IFID							
Type	I	I							

<u>VARIABLE</u>	<u>DESCRIPTION</u>
NID	Node ID or Node set ID to be moved by interface file, see *NODE or *SET_NODE.
IFID	Interface ID in interface file.

**Remarks:**

The difference between this keyword and \*INTERFACE\_LINKING\_DISCRETE\_... is that the constraint is done to the nearest node via a bucketsort during initialization. Nodes not found are reported and deleted from the list to tie. These nodes are treated just as if they were tied via the ..DISCRETE\_NODE option, they are constrained based on their location rather than the input order.

# **\*INTERFACE**

## **\*INTERFACE\_LINKING\_SEGMENT**

### **\*INTERFACE\_LINKING\_SEGMENT**

Purpose: Define an interface for linking segments to an interface file for the second analysis using L=isf2 on the execution command line. This applies segments on shell and solid elements.

Card            1            2            3            4            5            6            7            8

Variable	SSID	IFID						
Type	I	I						

#### **VARIABLE**

#### **DESCRIPTION**

SSID	Segment set to be moved by interface file.
IFID	Interface ID in interface file.

**\*INTERFACE\_SPRINGBACK\_OPTION1\_OPTION2**

Available options included for OPTION1 are:

**LSDYNA**

**NASTRAN**

**SEAMLESS**

and for OPTION2:

**THICKNESS**

**NOTHICKNESS**

See the remarks below.

Purpose: Define a material subset for an implicit springback calculation in LS-DYNA and any nodal constraints to eliminate rigid body degrees-of-freedom.

Card            1            2            3            4            5            6            7            8

Variable	PSID	NSHV	FTYPE		FTENSR	NTHHSV		INTSTRN
Type	I	I	I		I	I		I

<u>VARIABLE</u>	<u>DESCRIPTION</u>
PSID	Part set ID for springback, see *SET_PART.
NSHV	Number of shell or solid history variables (beyond the six stresses and effective plastic strain) to be initialized in the interface file. For solids, one additional state variable (initial volume) is also written. If NSHV is nonzero, the element formulations, calculational units, and constitutive models should not change between runs. If NHSV exceeds the number of integration point history variables required by the constitutive model, only the number required is written; therefore, if in doubt, set NHSV to a large number.

<u>VARIABLE</u>	<u>DESCRIPTION</u>
FTYPE	File type: EQ.0: ASCII, EQ.1: binary EQ.2: both ASCII and binary. EQ.10: ASCII large format (see *INITIAL_STRESS_SHELL) EQ.11: binary large format EQ.12: both ASCII and binary large format
FTENSR	Flag for dumping tensor data from the element history variables into the dynain file. EQ.0: Don't dump tensor data from element history variables EQ.1: Dump any tensor data from element history variables into the dynain file in GLOBAL coordinate system. Currently, only Material 190 supports this option.
NTHHSV	Number of thermal history variables.
INTSTRN	Output of strains at all integration points of shell element is requested, see also *INITIAL_STRAIN_SHELL

**Define a list of nodal points that are constrained for the springback. This section is terminated by an “\*” indicating the next input section.**

Card	1	2	3	4	5	6	7	8
------	---	---	---	---	---	---	---	---

Variable	NID	TC	RC					
Type	I	F	F					

<u>VARIABLE</u>	<u>DESCRIPTION</u>
NID	Node ID, see *NODE.
TC	Translational Constraint: EQ.0: no constraints, EQ.1: constrained x displacement, EQ.2: constrained y displacement, EQ.3: constrained z displacement, EQ.4: constrained x and y displacements, EQ.5: constrained y and z displacements, EQ.6: constrained z and x displacements. EQ.7: constrained x, y, and z displacements.

---

<u>VARIABLE</u>	<u>DESCRIPTION</u>
RC	Rotational constraint: EQ.0: no constraints, EQ.1: constrained x rotation, EQ.2: constrained y rotation, EQ.3: constrained z rotation, EQ.4: constrained x and y rotations, EQ.5: constrained y and z rotations, EQ.6: constrained z and x rotations, EQ.7: constrained x, y, and z rotations.

**Remarks:**

1. The NOTHICKNESS option is available for LS-DYNA and NASTRAN in which case the shell element thickness is not an output. The file name for LS-DYNA is “dynain” and for NASTRAN is “nastin.” The \*CONTROL\_ADAPTIVITY is available for LS-DYNA.
2. Trimming is available for the adaptive mesh but it requires some steps. To trim an adaptive mesh use the following procedure:
  - (1) Generate the file, “dynain” using the keyword \*INTERFACE\_SPRINGBACK\_LSDYNA.
  - (2) Prepare a new input deck including the file “dynain.”
  - (3) Add the keyword \*ELEMENT\_TRIM to this new deck.
  - (4) Add the keyword \*DEFINE\_CURVE\_TRIM to this new deck.
  - (5) Run this new input deck with i=input\_file\_name. The adaptive constraints are eliminated by remeshing and the trimming is performed.
  - (6) In case this new trimmed mesh is needed, run a zero termination time job and output the file generated via the keyword, \*INTERFACE\_SPRINGBACK\_LSDYNA.
3. Temperature – The file new\_temp\_ic.inc will be created for a thermal solution and a coupled thermal-mechanical solution. The file new\_temp\_ic.inc is a KEYWORD include file which contains “new temperature initial conditions” for the nodes belonging to the PSID.
4. For thermal user materials it is possible to dump thermal history variables using NTHHSV.

**Remarks for Seamless Springback:**

In seamless springback LS-DYNA automatically and seamlessly switches from explicit or implicit dynamic to implicit static mode at the end of a forming simulation, and continues to run the static springback analysis. Seamless springback can be activated in the original LS-DYNA input deck, or later using a small restart input deck. In this way, the user can decide to continue a previous forming analysis by restarting to add the implicit springback phase. (Another alternative approach to springback simulation is to use the keyword `*INTERFACE_SPRINGBACK_LSDYNA` to generate a "dynain" file after forming, and then perform a second simulation running LS-DYNA in fully implicit mode for springback. See Appendix P for a description of how to run an implicit analysis using LS-DYNA.

The implicit springback phase begins when the forming simulation termination time `ENDTIM` is reached, as specified with the keyword `*CONTROL_TERMINATION`. Since the springback phase is static, its termination time can be chosen arbitrarily (unless material rate effects are included). The default choice is `2.0*ENDTIM`, and can be changed using the `*CONTROL_IMPLICIT_GENERAL` keyword.

Since the springback analysis is a static simulation, a minimum number of essential boundary conditions or Single Point Constraints (SPC's) can be input to prohibit rigid body motion of the part. These boundary conditions can be added for the springback phase using the input option on the `*INTERFACE_SPRINGBACK_SEAMLESS` keyword above.

If no boundary conditions are added with the `SEAMLESS` option an eigenvalue computation is automatically performed using the Inertia Relief Option to find any rigid body modes and then automatically constrain them out of the springback simulation (see `*CONTROL_IMPLICIT_INERTIA_RELIEF`). This approach introduces no artificial deformation and is recommended for many simulations.

Several new `*CONTROL_IMPLICIT` keywords have been added to control the implicit springback phase. These keywords can also be added to a restart input deck. Generally, default settings can be used, so these keywords need not be included in the input deck.

To obtain accurate springback solutions, a nonlinear springback analysis must be performed. In many simulations, this iterative equilibrium search will converge without difficulty. If the springback simulation is particularly difficult, either due to nonlinear deformation, nonlinear material response, or numerical precision errors, a multi-step springback simulation will be automatically invoked. In this approach, the springback deformation is divided into several smaller, more manageable steps.

Two specialized features in LS-DYNA are used to perform multi-step springback analyses. The addition and gradual removal of artificial springs is performed by the artificial stabilization feature. Simultaneously, the automatic time step control is used to guide the solution to the termination time as quickly as possible, and to persistently retry steps where the equilibrium search has failed. By default, both of these features are active during a seamless springback simulation. However, the default method attempts to solve the springback problem in a single step. If this is successful, the solution will terminate normally. If the single step springback

analysis fails to converge, the step size will be reduced, and artificial stabilization will become active. Defaults for these features can be changed using the following keywords:

\*CONTROL\_IMPLICIT\_GENERAL, \*CONTROL\_IMPLICIT\_AUTO, and  
\*CONTROL\_IMPLICIT\_STABILIZATION.

**\*INTERFACE\_SSI\_{OPTION}\_ID**

Purpose: This card creates a tied-contact soil-structure interface for use in a transient analysis of a soil-structure system subjected to earthquake excitation. This card allows the analysis to start from a static state of the structure, as well as to read in ground motions recorded on the interface in an earlier analysis.

Available options are:

<BLANK>

**OFFSET**

**CONSTRAINED\_OFFSET**

LS-DYNA implements the effective seismic input method [Bielak and Christiano (1984)] for modeling the interaction of a non-linear structure with a linear soil foundation subjected to earthquake excitation. Note that any non-linear portion of the soil near the structure may be incorporated with the structure into a larger generalized structure, but the soil is assumed to behave linearly beyond a certain distance from the structure.

The effective seismic input method couples the dynamic scattered motion in the soil — the difference between the motion in the presence of the structure and the free-field motion in its absence — with the total motion of the structure. This replaces the distant earthquake source with equivalent effective forces adjacent to the soil-structure interface and allows truncation of the large soil domain using a non-reflecting boundary (e.g. \*MAT\_PML\_ELASTIC) to avoid unnecessary computation. These effective forces can be computed using the free-field ground motion at the soil-structure interface, thus avoiding deconvolution of the free-field motion down to depth.

Non-linear behavior of the structure may be modeled by first carrying out a static analysis of the soil-structure system, and then carrying out the transient analysis with only the structure initialized to its static state. Because the transient analysis employs the dynamic scattered motion in the soil, the soil cannot have any static loads only it — only the structure is subjected to static forces. Consequently, the structure must be supported by the static reactions at the soil-structure interface. Additionally, the soil nodes at the interface must be initialized to be compatible with the initial static displacement of the structure. LS-DYNA will do these automatically if the soil-structure interface is identified appropriately in the static analysis and reproduced in the transient analysis.

Thus, soil-structure interaction analysis under earthquake excitation may be carried out in LS-DYNA as follows:

0. Carry out a static analysis of the soil-structure system (e.g. using dynamic relaxation; see \*CONTROL\_DYNAMIC\_RELAXATION), with the soil-structure interface identified using \*INTERFACE\_SSI\_STATIC\_ID





**Optional card**

Card 3            1            2            3            4            5            6            7            8

Variable	GMSET	SF	BIRTH	DEATH	MEMGM			
Type	I	F	F	F	I			
Default	none	1.	0.	1.E+28	2500000			

**VARIABLE****DESCRIPTION**

ID	Soil-structure interface ID. This is required and must be unique amongst all the contact interface IDs in the model.
HEADING	A descriptor for the given ID.
STRID	Segment set ID of base of structure at soil-structure interface.
SOILID	Segment set ID of soil at soil-structure interface.
SPR	Include the slave side in the *DATABASE_NCFORC and the *DATABASE_BINARY_INTFOR interface force files: EQ.1: slave side forces included.
MPR	Include the master side in the *DATABASE_NCFORC and the *DATABASE_BINARY_INTFOR interface force files: EQ.1: master side forces included.
GMSET	Identifier for set of recorded motions from *INTERFACE_SSI_AUX or *INTERFACE_SSI_AUX_EMBEDDED
SF	Recorded motion scale factor. (default=1.0)
BIRTH	Time at which specified recorded motion is activated.
DEATH	Time at which specified recorded motion is removed: EQ.0.0: default set to 10 <sup>28</sup>
MEMGM	Size in words of buffer allocated to read in recorded motions

**Remarks:**

1. A tied contact interface (\*CONTACT\_TIED\_SURFACE\_TO\_SURFACE) is created between the structure and the soil using the specified segment sets, with the soil segment set as the master segment set and the structure segment set as the slave. Naturally, the two segment sets should not have merged nodes and can be non-matching in general. However, the area covered by the two surfaces should match.
2. The options OFFSET and CONSTRAINED\_OFFSET create the corresponding tied surface-to-surface contact interface.
3. The soil-structure interface ID is assigned as the ID of the generated contact interface.
4. It is assumed that the soil segment set is oriented toward the structure.
5. Multiple soil-structure interfaces are allowed, e.g. for bridge analysis.
6. The recorded motions are read in from a binary file named **gmbin** by default, but a different filename may be chosen using the option GMINP on the command line (see INTRODUCTION, Execution Syntax).
7. If the motions from \*INTERFACE\_SSI\_AUX or \*INTERFACE\_SSI\_AUX\_EMBEDDED were recorded on a segment set, then the free-field motions on each node in the master segment set of the soil-structure interface are calculated from the nearest segment of the segment set used to record the motions.

If however, the motions were recorded on a node set, then the motions on the master segment set nodes is found by interpolation as is done for \*LOAD\_SEISMIC\_SSI.

## \*INTERFACE\_SSI\_AUX\_{OPTION}

Available options are:

<BLANK>

NODE

Purpose: This card records the motion at a free surface, or on a set of nodes on a free surface, for the purpose of using the recorded motion as a free-field motion in a subsequent interaction analysis using \*INTERFACE\_SSI. By default, this card records motions on a segment set defining a surface, but can record motions on a node set using the option NODE. Only one of \*INTERFACE\_SSI\_AUX and \*INTERFACE\_SSI\_AUX\_EMBEDDED is to be used for a particular soil-structure interface.

Card 1            1            2            3            4            5            6            7            8

Variable	GMSET	SETID						
Type	I	I						
Default	none	none						

### VARIABLE

### DESCRIPTION

GMSET	Identifier for this set of recorded motions to be referred to in *INTERFACE_SSI. Must be unique.
SETID	Segment set or node set ID where motions are to be recorded.

### Remarks:

1. The motions on the specified segment set or node set is recorded in a binary file named **gmbin** by default, but a different filename may be chosen using option GMOUT on the command line (see INTRODUCTION, Execution Syntax).
2. The output interval for the motions may be specified using the parameter GMDT on the \*CONTROL\_OUTPUT card, with the default value being 1/10-th of the output interval for D3PLOT states.

\*INTERFACE\_SSI\_AUX\_EMBEDDED\_{OPTION1}\_{OPTION2}

Purpose: This card creates a tied-contact interface and records the motions and contact forces in order to use them as free-field motion and reactions in a subsequent soil-structure interaction analysis using \*INTERFACE\_SSI, where the structure is embedded in the soil after part of the soil has been excavated. Only one of \*INTERFACE\_SSI\_AUX and \*INTERFACE\_SSI\_AUX\_EMBEDDED is to be used for a particular soil-structure interface.

Available options for OPTION1 are:

<BLANK>

OFFSET

CONSTRAINED\_OFFSET

OPTION2 allows an optional ID to be given:

ID

The following card is read if and only if the ID option is specified. The second card is required.

Card 1 1 2-8

Variable	ID	HEADING
Type	I	A70

Card 2 1 2 3 4 5 6 7 8

Variable	GMSET	STRID	SOILID	SPR	MPR			
Type	I	I	I	I	I			
Default	none	none	none	0	0			

<u>VARIABLE</u>	<u>DESCRIPTION</u>
ID	Soil-structure interface ID. This is required and must be unique amongst all the contact interface IDs in the model.

<u>VARIABLE</u>	<u>DESCRIPTION</u>
HEADING	A descriptor for the given ID.
GMSET	Identifier for this set of recorded motions to be referred to in *INTERFACE_SSI. Must be unique.
STRID	Segment set ID at base of soil to be excavated.
SOOLID	Segment set ID at face of rest of the soil domain.
SPR	Include the slave side in the *DATABASE_NCFORC and the *DATABASE_BINARY_INTFOR interface force files: EQ.1: slave side forces included.
MPR	Include the master side in the *DATABASE_NCFORC and the *DATABASE_BINARY_INTFOR interface force files: EQ.1: master side forces included.

**Remarks:**

3. The motions on the specified segment set or node set is recorded in a binary file named **gmbin** by default, but a different filename may be chosen using option GMOUT on the command line (see INTRODUCTION, Execution Syntax).
4. The output interval for the motions may be specified using the parameter GMDT on the \*CONTROL\_OUTPUT card, with the default value being 1/10-th of the output interval for D3PLOT states.

**\*INTERFACE\_SSI\_STATIC\_{OPTION}\_ID**

Purpose: This card creates a tied-contact soil-structure interface in order to record the static reactions at the base of the structure, which are to be used in a subsequent dynamic analysis of the soil-structure system subjected to earthquake excitation. This card is intended to be used with the initial static analysis of the structure subjected to gravity loads.

Available options are:

<BLANK>

OFFSET

CONSTRAINED\_OFFSET

Card 1                                1    2-8

Variable	ID	HEADING
Type	I	A70

Card 2                                1                                2                                3                                4                                5                                6                                7                                8

Variable	STRID	SOILID	SPR	MPR				
Type	I	I	I	I				
Default	none	none	0	0				

<u>VARIABLE</u>	<u>DESCRIPTION</u>
ID	Soil-structure interface ID. This is required and must be unique amongst all the contact interface IDs in the model.
HEADING	A descriptor for the given ID.
STRID	Segment set ID of base of structure at soil-structure interface.
SOILID	Segment set ID of soil at soil-structure interface.

<u>VARIABLE</u>	<u>DESCRIPTION</u>
SPR	Include the slave side in the *DATABASE_NCFORC and the *DATABASE_BINARY_INTFOR interface force files: EQ.1: slave side forces included.
MPR	Include the master side in the *DATABASE_NCFORC and the *DATABASE_BINARY_INTFOR interface force files: EQ.1: master side forces included.

**Remarks:**

See \*INTERFACE\_SSI\_ID. The ID used for a particular interface in the static analysis must also be used for the same interface identified using \*INTERFACE\_SSI\_ID during dynamic analysis.



# **\*KEYWORD**

**\*KEYWORD**\_{OPTION} {MEMORY} {NCPU=n}

Available options include:

**<BLANK>**

**ID**

**JOBID**

Purpose: The keyword, **\*KEYWORD**, flags LS-DYNA that the input deck is a keyword deck rather than the structured format, which has a strictly defined format. This must be the first card in the input file. Alternatively, by typing “keyword” on the execution line, keyword input formats are assumed and this beginning “**\*KEYWORD**” line is not required.

There are 2 optional parameters that can be specified with the **\*KEYWORD** which can be listed in any order. If a number {MEMORY} is specified after the word **\*KEYWORD**, it defines the memory size to be used in words. The memory size can also be set on the command line. Note that the memory size specified on the **\*KEYWORD** card is overridden by the memory specified on the execution line. If the parameter {NCPU=n} is specified it defines the number of CPUs “n” to be used during the analysis. This only applies to the Shared Memory Parallel (SMP) version of LS-DYNA. For the Distributed Memory Version (MPP) the number of CPUs is always defined with the “mpirun” command. Defining the number of CPUs on the execution line overrides what is specified with the **\*KEYWORD** command and both override the number of CPUs specified by **\*CONTROL\_PARALLEL**. An example of the {MEMORY} and {NCPU=n} options would be the follows:

**\*KEYWORD 12000000 NCPU=2**

This **\*KEYWORD** command is requesting 12 million words of memory and 2 CPUs to be used for the analysis.

The ID and JOBID command line options are available to add a prefix to all output and scratch filenames, i.e., not the input filenames. This allows multiple simulations in a directory since a different prefix prevents files from being overwritten. If the ID option is used, the prefix is constructed of three user specified strings separated by “\_” characters.

# \*KEYWORD

---

## Optional card if the ID option is active.

Card 1            1            2            3            4            5            6            7            8

Variable	PROJECT	NUM	STAGE
Type	A	A	A
Default	none	none	none

---

**VARIABLE**

---

---

**DESCRIPTION**

---

PROJECT	First part of the file name prefix.
NUM	Second part of the file name prefix.
STAGE	Third part of the file name prefix.

An example, the prefix with the file name given on the optional card for file D3PLOT would be the following:

PROJECT\_NUM\_STAGE.D3PLOT

The prefix can also be assigned by the option, jobid on the execution line. The execution line would look like the following:

ls971 i=input.k jobid= PROJECT\_NUM\_STAGE

When the JOBID command line option is used, the prefix is the single JOBID string assigned by the user. The behavior is the same as jobid option on the execution line.

## Optional card if the JOBID option is active.

Card 1            1            2            3            4            5            6            7            8

Variable	JOBID
Type	A
Default	none

# **\*LOAD**

The keyword \*LOAD provides a way of defining applied forces. The keyword control cards in this section are defined in alphabetical order:

- \*LOAD\_ALE\_CONVECTION\_{OPTION}**
- \*LOAD\_BEAM\_OPTION**
- \*LOAD\_BLAST**
- \*LOAD\_BLAST\_ENHANCED**
- \*LOAD\_BLAST\_SEGMENT**
- \*LOAD\_BLAST\_SEGMENT\_SET**
- \*LOAD\_BODY\_OPTION**
- \*LOAD\_BODY\_GENERALIZED**
- \*LOAD\_BODY\_POROUS**
- \*LOAD\_BRODE**
- \*LOAD\_DENSITY\_DEPTH**
- \*LOAD\_ERODING\_PART\_SET**
- \*LOAD\_GRAVITY\_PART**
- \*LOAD\_HEAT\_CONTROLLER**
- \*LOAD\_HEAT\_GENERATION\_OPTION**
- \*LOAD\_MASK**
- \*LOAD\_MOTION\_NODE**
- \*LOAD\_MOVING\_PRESSURE**
- \*LOAD\_NODE\_OPTION**
- \*LOAD\_REMOVE\_PART**
- \*LOAD\_RIGID\_BODY**
- \*LOAD\_SEGMENT\_{OPTION}**
- \*LOAD\_SEGMENT\_NONUNIFORM\_{OPTION}**
- \*LOAD\_SEGMENT\_SET\_{OPTION}**
- \*LOAD\_SEGMENT\_SET\_ANGLE**
- \*LOAD\_SEGMENT\_SET\_NONUNIFORM\_{OPTION}**
- \*LOAD\_SEISMIC\_SSI\_OPTION1\_{OPTION2}**

# **\*LOAD**

---

**\*LOAD\_SHELL\_{OPTION1}\_{OPTION2}**  
**\*LOAD\_SPCFORC**  
**\*LOAD\_SSA**  
**\*LOAD\_STEADY\_STATE\_ROLLING**  
**\*LOAD\_STIFFEN\_PART**  
**\*LOAD\_SUPERPLASTIC\_FORMING**  
**\*LOAD\_SURFACE\_STRESS\_OPTION**  
**\*LOAD\_THERMAL\_OPTION**  
**\*LOAD\_THERMAL\_CONSTANT**  
**\*LOAD\_THERMAL\_CONSTANT\_ELEMENT**  
**\*LOAD\_THERMAL\_CONSTANT\_NODE**  
**\*LOAD\_THERMAL\_LOAD\_CURVE**  
**\*LOAD\_THERMAL\_TOPAZ**  
**\*LOAD\_THERMAL\_VARIABLE**  
**\*LOAD\_THERMAL\_VARIABLE\_BEAM\_{OPTION}**  
**\*LOAD\_THERMAL\_VARIABLE\_ELEMENT\_{OPTION}**  
**\*LOAD\_THERMAL\_VARIABLE\_NODE**  
**\*LOAD\_THERMAL\_VARIABLE\_SHELL\_{OPTION}**  
**\*LOAD\_VOLUME\_LOSS**

**\*LOAD\_ALE\_CONVECTION\_{OPTION}**

Purpose: This card is used to define the convection thermal energy transfer from a hot ALE fluid to the surrounding Lagrangian structure (remark 1). It is associated with a corresponding coupling card defining the interaction between the ALE fluid and the Lagrangian structure. It is only used when thermal energy transfer from the ALE fluid to the surrounding Lagrangian structure is significant. This is designed specifically for airbag deployment application where the heat transfer from the inflator gas to the inflator compartment can significantly affect the inflation potential of the inflator.

Available options include:

<BLANK>

**ID**

To define an ID number for each convection heat transfer computation in an optional card preceding all other cards for this command. This ID number can be used to output the part temperature and temperature change as functions of time in the \*DATABASE\_FSI card. To do this, set the CONVID parameter in the \*DATABASE\_FSI card equal to this ID.

Card	1	2	3	4	5	6	7	8
Variable	LAGPID	LAGT	LAGCP	H	LAGMAS			
Type	I	F	F	F	F			
Default	none	none	none	none	none			
Remarks								

**VARIABLE****DESCRIPTION**

LAGPID	Lagrangian PID (slave PID) from a corresponding coupling card which receives the thermal energy in the convection heat transfer.
LAGT	Initial temperature of this Lagrangian slave part.
LAGCP	Constant-pressure heat capacity of this Lagrangian slave part. It has a per-mass unit (for example, J/[Kg*K]).

<u>VARIABLE</u>	<u>DESCRIPTION</u>
H	Convection heat transfer coefficient on this Lagrangian slave part surface. It is the amount of energy (J) transferred per unit area, per time, and per temperature difference. For example, its units may be $J/[m^2*s*K]$
LAGMAS	The mass of the Lagrangian slave part receiving the thermal energy. This is in absolute mass unit (for example, Kg).

**Remarks:**

1. The only application of this card so far has been for the transfer of thermal energy from the ALE hot inflator gas to the surrounding Lagrangian structure (inflator canister and airbag-containing compartment) in an airbag deployment model.
2. The heat transferred is taken out of the inflator gas thermal energy thus reducing its inflating potential.
3. This is not a precise heat transfer modeling attempt. It is simply one mechanism for taking out excessive energy from the inflating potential of the hot inflator gas.
4. The heat transfer formulation may roughly be represented as following. Some representative units are shown just for clarity.

$$\dot{Q} = H * A * \Delta T \sim \text{Watt} \sim \frac{J}{s} \sim \left[ \frac{J}{m^2 * s * K} \right] * m^2 * K$$

$$\dot{Q} * dt = \dot{M} * C_p * [T_{Lag\_new} - T_{Lag\_orig}] \sim \frac{kg}{s} * \left[ \frac{J}{kg * K} \right] * K \sim \frac{J}{s}$$

**\*LOAD\_BEAM\_OPTION**

Available options include:

**ELEMENT**

**SET**

Purpose: Apply the distributed traction load along any local axis of beam or a set of beams. The local axes are defined in Figure 25.1, see also \*ELEMENT\_BEAM.

Card            1            2            3            4            5            6            7            8

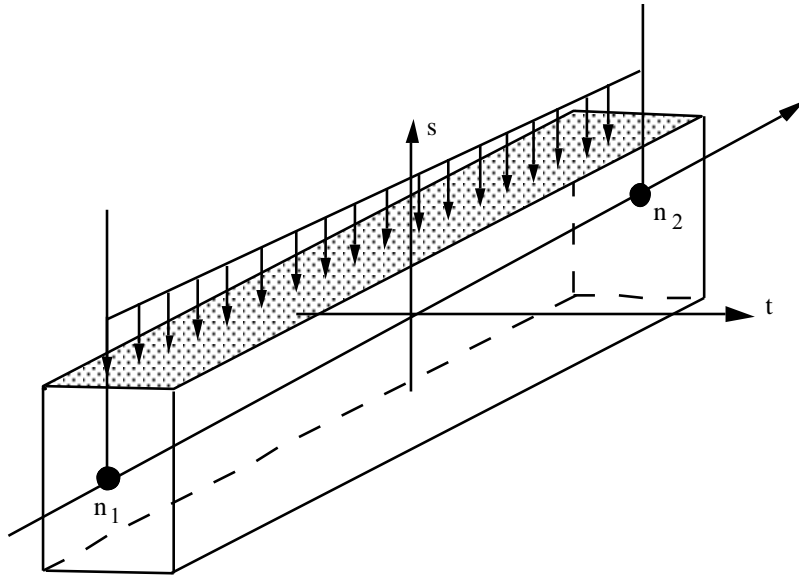
Variable	EID/ESID	DAL	LCID	SF				
Type	I	I	I	F				
Default	none	none	none	1.				
Remarks								

<u>VARIABLE</u>	<u>DESCRIPTION</u>
EID/ESID	Beam ID (EID) or beam set ID (ESID), see *ELEMENT_BEAM or *SET_BEAM.
DAL	Direction of applied load: EQ.1: parallel to r-axis of beam, EQ.2: parallel to s-axis of beam, EQ.3: parallel to t-axis of beam.
LCID	Load curve ID (see *DEFINE_CURVE) or function ID (see *DEFINE_FUNCTION).
SF	Load curve scale factor. This is for a simple modification of the function values of the load curve.

**Remarks:**

1. The function defined by LCID has 7 arguments: time, the 3 current coordinates, and the 3 reference coordinates. A function that applies a force proportional to the distance from

the initial coordinates would be  $f(t, x, y, z, x_0, y_0, z_0) = -10.*\text{sqrt}((x-x_0)*(x-x_0) + (y-y_0)*(y-y_0) + (z-z_0)*(z-z_0))$ .



**Figure 25.1.** Applied traction loads are given in force per unit length. The *s* and *t* directions are defined on the \*ELEMENT\_BEAM keyword.



**\*LOAD\_BLAST**

Purpose: Define an airblast function for the application of pressure loads due to explosives in conventional weapons. The implementation is based on a report by Randers-Pehrson and Bannister [1997] where it is mentioned that this model is adequate for use in engineering studies of vehicle responses due to the blast from land mines. This option determines the pressure values when used in conjunction with the keywords: \*LOAD\_SEGMENT, \*LOAD\_SEGMENT\_SET, or \*LOAD\_SHELL.

Card 1            1            2            3            4            5            6            7            8

Variable	WGT	XBO	YBO	ZBO	TBO	IUNIT	ISURF	
Type	F	F	F	F	F	I	I	
Default	none	0.0	0.0	0.0	0.0	2	2	

Card 2            1            2            3            4            5            6            7            8

Variable	CFM	CFL	CFT	CFP	DEATH			
Type	F	F	F	F	F			
Default	0.0	0.0	0.0	0.0	0.0			

<u>VARIABLE</u>	<u>DESCRIPTION</u>
WGT	Equivalent mass of TNT.
XBO	x-coordinate of point of explosion.
YBO	y-coordinate of point of explosion.
ZBO	z-coordinate of point of explosion.
TBO	Time-zero of explosion.

<b>VARIABLE</b>	<b>DESCRIPTION</b>
IUNIT	Unit conversion flag. EQ.1: feet, pound-mass, seconds, psi EQ.2: meters, kilograms, seconds, Pascals (default) EQ.3: inch, dozens of slugs, seconds, psi EQ.4: centimeters, grams, microseconds, Megabars EQ.5: user conversions will be supplied (see Card 2)
ISURF	Type of burst. EQ.1: surface burst - is located on or very near the ground surface (see Remark 5) EQ.2: air burst - spherical charge (default)
CFM	Conversion factor - pounds per LS-DYNA mass unit.
CFL	Conversion factor - feet per LS-DYNA length units.
CFT	Conversion factor - milliseconds per LS-DYNA time unit.
CFP	Conversion factor - psi per LS-DYNA pressure unit
DEATH	Death time. Blast pressures are deactivated at this time.

**Remarks:**

1. A minimum of two load curves, even if unreferenced, must be present in the model.
2. Segment normals should point toward the charge.
3. Several methods can be used to approximate the equivalent mass of TNT for a given explosive. The simplest involves scaling the mass by the ratio of the Chapman-Jouguet detonation velocities given the by relationship.

$$M_{\text{TNT}} = M \frac{\text{DCJ}^2}{\text{DCJ}_{\text{TNT}}^2}$$

where  $M_{\text{TNT}}$  is the equivalent TNT mass and  $\text{DCJ}_{\text{TNT}}$  is the Chapman-Jouguet detonation velocity of TNT.  $M$  and  $\text{DCJ}$  are, respectively, the mass and C-J velocity of the explosive under consideration. "Standard" TNT is considered to be cast with a density of  $1.57 \text{ gm/cm}^3$  and  $\text{DCJ}_{\text{TNT}}=0.693 \text{ cm/microsecond}$ .

4. The empirical equations underlying the spherical burst feature are valid for the range of scaled distance  $0.37 \text{ ft/lbm}^{1/3} < Z < 100 \text{ ft/lbm}^{1/3}$  where  $Z=R/M^{1/3}$ ,  $R$  is the distance in feet from the charge center to the target and  $M$  is the TNT equivalent mass of the

---

charge in lbm. The range of applicability for the hemispherical burst is  $0.45 \text{ ft/lbm}^{1/3} < Z < 100 \text{ ft/lbm}^{1/3}$ .

5. When a charge is located on or very near the the ground surface it is considered to be a surface burst. Under this circumstance the initial blast wave is immediately reflected and reinforced by the nearly unyielding ground to produce a reflected wave that moves out hemispherically from the point of burst. This reflected wave merged with the initial incident wave produces overpressures which are greater than those produced by the initial wave alone. In LS-DYNA this wave moves out spherically from the burst point so no distinction of the ground orientation is made. Target points equidistant from the burst point are loaded identically with the surface burst option.

# \*LOAD

# \*LOAD\_BLAST\_ENHANCED

## \*LOAD\_BLAST\_ENHANCED

Purpose: Define an airblast function for the application of pressure loads due the explosion of conventional charge. While similar to \*LOAD\_BLAST this feature includes enhancements for treating reflected waves, moving warheads and multiple blast sources. The loads are applied to facets defined with the keyword \*LOAD\_BLAST\_SEGMENT. A database containing blast pressure history is also available (see \*DATABASE\_BINARY\_BLSFOR).

Card 1            1            2            3            4            5            6            7            8

Variable	BID	M	XBO	YBO	ZBO	TBO	UNIT	BLAST
Type	I	F	F	F	F	F	I	I
Default	none	0.0	0.0	0.0	0.0	0.0	2	2
Remarks		1				3	4	7

Card 2            1            2            3            4            5            6            7            8

Variable	CFM	CFL	CFT	CFP	NIDBO	DEATH	NEGPHS	
Type	F	F	F	F	I	F	I	
Default	0.0	0.0	0.0	0.0	none	1.e+20	0	

### VARIABLE

### DESCRIPTION

BID	Blast ID. A unique number must be defined for each blast source (charge). Multiple charges may be defined, however, interaction of the waves in air is not considered.
M	Equivalent mass of TNT (see Remark 1).
XBO	x-coordinate of charge center.
YBO	y-coordinate of charge center.

---

<u>VARIABLE</u>	<u>DESCRIPTION</u>
ZBO	z-coordinate of charge center.
TBO	Time of detonation.
UNIT	Unit conversion flag. See Remark 4. EQ.1: pound-mass, foot,second, psi EQ.2: kilogram, meter,second, Pascal (default) EQ.3: dozen slugs (i.e., lbf-s <sup>2</sup> /in), inch, second, psi EQ.4: centimeters, grams, microseconds, Megabars EQ.5: user conversions will be supplied (see Card 2) EQ.6: kilogram, millimeter,millisecond,GPa EQ.7: metric ton, millimeter, second, Mpa EQ.8: gram, millimeter, millisecond, MPa
BLAST	Type of blast source. EQ.1: hemispherical surface burst – charge is located on or very near the ground surface (see Remark 7) EQ.2: spherical free-air burst (default) – no amplification of the initial shock wave due to interaction with the ground surface EQ.3: air burst – moving non-spherical warhead EQ.4: air burst with ground reflection – initial shock wave impinges on the ground surface and is reinforced by the reflected wave to produce a Mach front (see Remark 8).
CFM	Conversion factor - pounds per LS-DYNA mass unit.
CFL	Conversion factor - feet per LS-DYNA length units.
CFT	Conversion factor - milliseconds per LS-DYNA time unit.
CFP	Conversion factor - psi per LS-DYNA pressure unit.
NIDBO	Optional node ID representing the charge center. If non-zero then XBO, YBO and XBO are ignored.
DEATH	Death time. Blast pressures are deactivated at this time.
NEGPHS	Treatment of negative phase. EQ.0: negative dictated by the Friedlander equation. EQ.1: negative phase ignored as in ConWep.

# \*LOAD

# \*LOAD\_BLAST\_ENHANCED

No further input is required for BLAST=1 or 2. Additional input is required for BLAST=3 and 4.

This Card 3 is mandatory for BLAST=3 (moving non-spherical warhead).

Card 3            1            2            3            4            5            6            7            8

Variable	VEL	TEMP	RATIO	VID				
Type	F	F	F	F				
Default	0.0	70.0	1.0	none				

## VARIABLE

## DESCRIPTION

VEL	Speed of warhead.
TEMP	Ambient air temperature, Fahrenheit.
RATIO	Aspect ratio of the non- spheroidal blast front. This is the longitudinal axis radius divided by the lateral axis radius. Shaped charge and EFP warheads typically have significant lateral blast resembling an oblate spheroid with RATIO<1. Cylindrically cased explosives produce more blast in the longitudinal direction so RATIO>1, rendering a prolate spheroid blast front, is more appropriate..
VID	Vector ID representing the longitudinal axis of the warhead (see *DEFINE_VECTOR). This vector is parallel to the velocity vector when a non-zero velocity VEL is defined.

This Card 3 is mandatory for BLAST=4 (spherical air burst with ground reflection).

Card 3            1            2            3            4            5            6            7            8

Variable	GNID	GVID						
Type	I	I						
Default	none	none						

VARIABLE	DESCRIPTION
GNID	ID of node residing on the ground surface.
GVID	ID of vector representing the vertically upward direction, i.e., normal to the ground surface (see *DEFINE_VECTOR).

**Remarks:**

- Several methods can be used to approximate the equivalent mass of TNT for a given explosive. The simplest involves scaling the mass by the ratio of the Chapman-Jouguet detonation velocities given the by relationship.

$$M_{TNT} = M \frac{DCJ^2}{DCJ_{TNT}^2}$$

where  $M_{TNT}$  is the equivalent TNT mass and  $DCJ_{TNT}$  is the Chapman-Jouguet detonation velocity of TNT.  $M$  and  $DCJ$  are, respectively, the mass and C-J velocity of the explosive under consideration. "Standard" TNT is considered to be cast with a density of  $1.57 \text{ gm/cm}^3$  and  $DCJ_{TNT}=0.693 \text{ cm/microsecond}$ .

- Segment normals should nominally point toward the charge unless it is the analyst's intent to specifically apply pressure to the leeward side of a structure. The angle of incidence is zero when the segment normal points directly at the charge. Only incident pressure is applied to a segment when the angle of incidence is greater than 90 degrees.
- The blast time offset TBO can be used to adjust the detonation time of the charge relative to the start time of the LS-DYNA simulation. The detonation time is delayed when TBO is positive. More commonly, TBO is set negative so that the detonation occurs before time-zero of the LS-DYNA calculation. In this manner, computation time is not wasted while "waiting" for the blast wave to reach the structure. The following message, written to the messag and d3hsp files as well as the screen, is useful in setting TBO.

```
Blast wave reaches structure at 2.7832E-01 milliseconds
```

As an example, one might run LS-DYNA for one integration cycle and record the arrival time listed in the message above. Then TBO is set to a negative number slightly smaller in magnitude than the reported arrival time, for example  $TBO = -0.275$  milliseconds. Under this circumstance the blast wave would reach the structure shortly after the start of the simulation.

- Computation of blast pressure relies on an underlying method which uses base units of lbm-foot-millisecond-psi; note that this internal unit system is inconsistent. Calculations require that the system of units in which the LS-DYNA model is constructed must be converted to this internal set of units. Predefined and user-defined

unit conversion factors are available (see the parameter UNIT) and these unit conversion factors are echoed back in the d3hsp file. Below is an example of user-defined (UNIT=5) conversion factors for the gm-mm-millisecond-Mpa unit system.

$$\text{CFM} = [ \text{lbm} / \text{LS-DYNA mass unit} ] = [ 2.2\text{e-}3 \text{ lbm} / \text{gm} ] = 2..2\text{e-}3$$

$$\text{CFL} = [ \text{feet} / \text{LS-DYNA length unit} ] = [ 3.28\text{e-}3 \text{ feet} / \text{mm} ] = 3.28\text{e-}3$$

$$\text{CFT} = [ \text{millisecond} / \text{LS-DYNA time unit} ] = [ 1.0 \text{ msec} / \text{msec} ] = 1.0$$

$$\text{CFP} = [ \text{psi} / \text{LS-DYNA pressure unit} ] = [ 145. \text{ psi} / \text{MPa} ] = 145.0$$

5. The empirical equations underlying the spherical burst feature are valid for the range of scaled distance  $0.37 \text{ ft/lbm}^{1/3} < Z < 100 \text{ ft/lbm}^{1/3}$  where  $Z=R/M^{1/3}$ , R is the distance in feet from the charge center to the target and M is the TNT equivalent mass of the charge in lbm. The range of applicability for the hemispherical burst is  $0.45 \text{ ft/lbm}^{1/3} < Z < 100 \text{ ft/lbm}^{1/3}$ .
6. Blast loads can be used in 2D axisymmetric analyses. Repeat the second node for the third and fourth nodes of the segment definition in \*LOAD\_BLAST\_SEGMENT and \*LOAD\_BLAST\_SEGMENT\_SET.
7. When a charge is located on or very near the the ground surface it is considered to be a surface burst. Under this circumstance the initial blast wave is immediately reflected and reinforced by the nearly unyielding ground to produce a reflected hemispherical wave that moves out from the point of burst. This reflected wave merged with the initial incident wave produces overpressures which are greater than those produced by the initial wave alone. In LS-DYNA this wave moves out spherically from the burst point so no distinction of the ground orientation is made. Target points equidistant from the burst point are loaded identically with the surface burst option.
7. The empirical equations underlying the spherical air burst with ground reflection (BLAST=4) are valid for the range of scaled height of burst  $1.0 \text{ ft/lbm}^{1/3} < Hc/M^{1/3} < 7.0 \text{ ft/lbm}^{1/3}$  where Hc is the height in feet from the charge center to the ground and M is the TNT equivalent mass of the charge in lbm.



**\*LOAD\_BLAST\_SEGMENT**

Purpose: Apply blast pressure loading over one triangular or quadrilateral segment defined by for nodes (see \*LOAD\_BLAST\_ENHANCED).

Card 1            1            2            3            4            5            6            7            8

Variable	BID	N1	N2	N3	N4	ALEPID	SFNRB	SCALEP
Type	I	I	I	I	I	I	F	F
Default	none	none	none	none	none	none	0.	1.

**VARIABLE****DESCRIPTION**

BID	Blast source ID (see *LOAD_BLAST_ENHANCED).
N1	Node ID.
N2	Node ID.
N3	Node ID.
N4	Node ID.
ALEPID	Part ID of ALE ambient part underlying this segment to be loaded by this blast (see *PART and *SECTION_SOLID, AET=5). This applies only when the blast load is coupled to an ALE air domain.
SFNRB	Scale factor for the ambient element non-reflecting boundary condition. Shocks waves reflected back to the ambient elements can be attenuated with this feature. A value of 1.0 works well for most situations. The feature is disabled when a value of zero is specified
SCALEP	Pressure scale factor.

**Remarks:**

1. Triangular segments are defined by repeating the third node.

# \*LOAD

# \*LOAD\_BLAST\_SEGMENT\_SET

## \*LOAD\_BLAST\_SEGMENT\_SET

Purpose: Apply blast pressure loading over each segment in a segment set (see \*LOAD\_BLAST\_ENHANCED).

Card 1            1            2            3            4            5            6            7            8

Variable	BID	SSID	ALEPID	SFNRB	SCALEP			
Type	I	I	I	F	F			
Default	none	none	none	0.	1.			

### VARIABLE

### DESCRIPTION

BID	Blast source ID (see *LOAD_BLAST_ENHANCED).
SSID	Segment set ID (see *SET_SEGMENT).
ALEPID	Part ID of ALE ambient part underlying this segment to be loaded by this blast (see *PART and *SECTION_SOLID, AET=5). This applies only when the blast load is coupled to an ALE air domain.
SFNRB	Scale factor for the ambient element non-reflecting boundary condition. Shocks waves reflected back to the ambient elements can be attenuated with this feature. A value of 1.0 works well for most situations.
SCALEP	Pressure scale factor.

**\*LOAD\_BODY\_OPTION**

Available options include for base accelerations:

**X**

**Y**

**Z**

for angular velocities:

**RX**

**RY**

**RZ**

for loading in any direction, specified by vector components:

**VECTOR**

and to specify a part set:

**PARTS**

Purpose: Define body force loads due to a prescribed base acceleration or angular velocity using global axes directions. This data applies to all nodes in the complete problem unless a part subset is specified via the \*LOAD\_BODY\_PARTS keyword. If a part subset is defined then all nodal points belonging to the subset will have body forces applied. The parts specified via the \*LOAD\_BODY\_PARTS keyword apply to the options X, Y, Z, RX, RY, and RZ above, i.e., different part sets may not apply to different options. Only one part set is expected. **Note: This option applies nodal forces, i.e., it cannot be used to prescribe translational or rotational motion.** Two keyword definitions are needed to apply body loads on a subset of parts: \*LOAD\_BODY\_X and \*LOAD\_BODY\_PARTS.

**For options: X, Y, Z, RX, RY, RZ and VECTOR.**

Card 1            1            2            3            4            5            6            7            8

Variable	LCID	SF	LCIDDR	XC	YC	ZC	CID	
Type	I	F	I	F	F	F	I	
Default	none	1.	0	0.	0.	0.	0	

# \*LOAD

\*LOAD\_BODY

## For option: PARTS.

Card 1            1            2            3            4            5            6            7            8

Variable	PSID							
Type	I							
Default	none							

## For option: VECTOR.

REQ 2            1            2            3            4            5            6            7            8

Variable	V1	V2	V3					
Type	F	F	F					
Default	0.0	0.0	0.0					

### VARIABLE

### DESCRIPTION

LCID	Load curve ID, see *DEFINE_CURVE.
SF	Load curve scale factor
LCIDDR	Load curve ID for dynamic relaxation phase (optional). This is needed when dynamic relaxation is defined and a different load curve to LCID is required during the dynamic relaxation phase. Note if LCID is undefined then no body load will be applied during dynamic relaxation regardless of the value LCIDDR. See *CONTROL_DYNAMIC_RELAXATION
XC	X-center of rotation, define for angular velocities.
YC	Y-center of rotation, define for angular velocities.
ZC	Z-center of rotation, define for angular velocities.
CID	Coordinate system ID to define acceleration in local coordinate system. The accelerations (LCID) are with respect to CID. EQ.0: global

VARIABLE	DESCRIPTION
PSID	Part set ID.
V1, V2, V3	Vector components of vector V.

**Remarks:**

1. Translational base accelerations allow body forces loads to be imposed on a structure. Conceptually, base acceleration may be thought of as accelerating the coordinate system in the direction specified, and, thus, the inertial loads acting on the model are of opposite sign. For example, if a cylinder were fixed to the y-z plan and extended in the positive x-direction, then a positive x-direction base acceleration would tend to shorten the cylinder, i.e., create forces acting in the negative x-direction.
2. Base accelerations are frequently used to impose gravitational loads during dynamic relaxation to initialize the stresses and displacements. During the analysis, in this latter case, the body forces loads are held constant to simulate gravitational loads. When imposing loads during dynamic relaxation, it is recommended that the load curve slowly ramp up to avoid the excitation of a high frequency response.
3. Body force loads due to the angular velocity about an axis are calculated with respect to the deformed configuration and act radially outward from the axis of rotation. Torsional effects which arise from changes in angular velocity are neglected with this option. The angular velocity is assumed to have the units of radians per unit time.
4. The body force density is given at a point P of the body by:

$$b = \rho (\omega \times \omega \times r)$$

where  $\rho$  is the mass density,  $\omega$  is the angular velocity vector, and  $r$  is a position vector from the origin to point P. Although the angular velocity may vary with time, the effects of angular acceleration are not included.

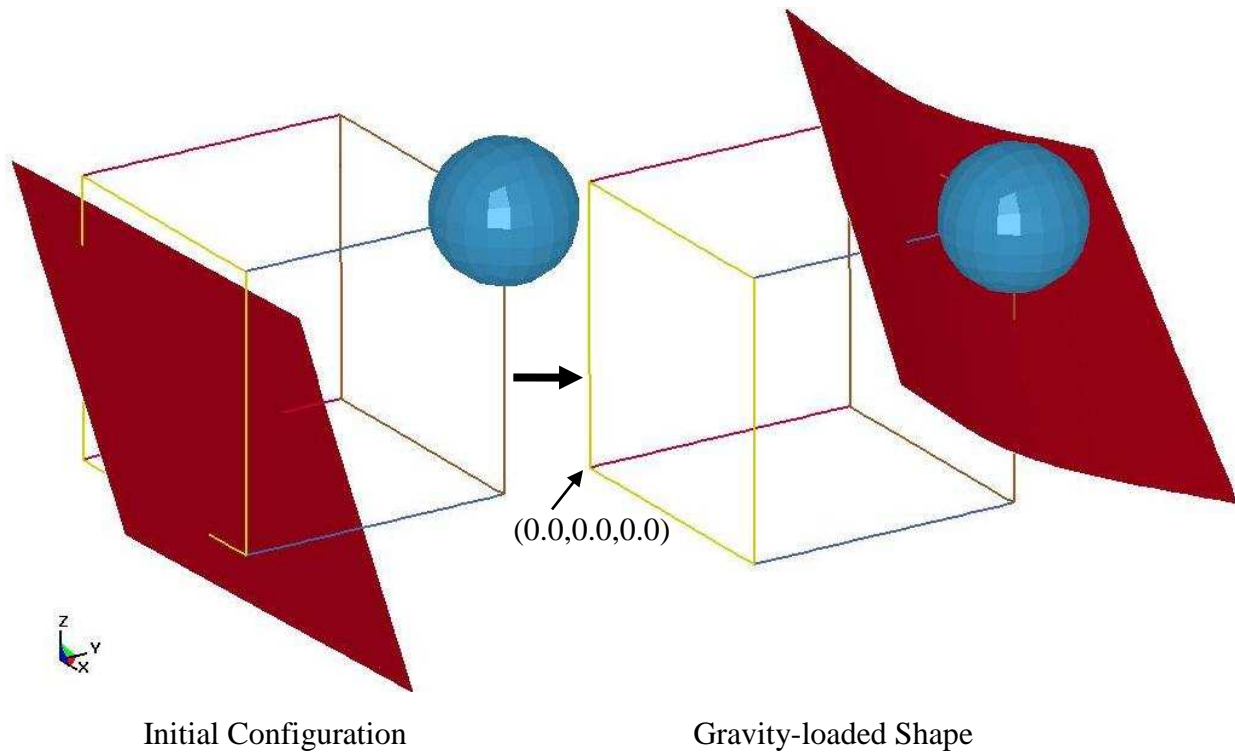
5. Angular velocities are useful for studying transient deformation of spinning three-dimensional objects. Typical applications have included stress initialization during dynamic relaxation where the initial rotational velocities are assigned at the completion of the initialization, and this option ceases to be active.

```

$$$$$$$$$$$$$$$$$$$$$$$$$$$$$$$$$$$$$$$$$$$$$$$$$$$$$$$$$$$$$$$$$$$$$$$$$$$$$$$$
$
$$$$ *LOAD_BODY_Z
$
$$$$$$$$$$$$$$$$$$$$$$$$$$$$$$$$$$$$$$$$$$$$$$$$$$$$$$$$$$$$$$$$$$$$$$$$$$$$$$$$
$
$ Add gravity such that it acts in the negative Z-direction.
$ Use units of mm/ms2. Since gravity is constant, the load
$ curve is set as a constant equal to 1. If the simulation

```





- 8. The `_VECTOR` option is available in LS-DYNA R5 Revision 59290 and later releases.

# \*LOAD

# \*LOAD\_BODY\_GENERALIZED

## \*LOAD\_BODY\_GENERALIZED\_OPTION

Available options include:

### SET\_NODE

### SET\_PART

Purpose: Define body force loads due to a prescribed base acceleration or a prescribed angular motion over a subset of the complete problem. The subset is defined by using nodes. Warning: Nodes, which belong to rigid bodies, should not be specified. Rigid bodies must be included within the part sets definitions.

Card 1            1            2            3            4            5            6            7            8

Variable	N1/SID	N2/0	LCID	DRLCID	XC	YC	ZC	
Type	I	I	I	I	F	F	F	
Default	none	none	none	0	0.	0.	0.	
Remarks								

Card 2            1            2            3            4            5            6            7            8

Variable	AX	AY	AZ	OMX	OMY	OMZ	CID	ANGTYP
Type	F	F	F	F	F	F	I	A
Default	0.	0.	0.	0.	0.	0.	0	CENT
Remarks	1, 2	1, 2	1, 2	3, 4, 5	3, 4, 5	3, 4, 5	optional	3

### VARIABLE

### DESCRIPTION

N1/SID

Beginning node ID for body force load or the node or part set ID.

N2

Ending node ID for body force load. Set to zero if a set ID is defined.



<u>VARIABLE</u>	<u>DESCRIPTION</u>
LCID	Load curve ID, see *DEFINE_CURVE.
DRLCID	Load curve ID for dynamic relaxation phase. Only necessary if dynamic relaxation is defined. See *CONTROL_DYNAMIC_RELAXATION.
XC	X-center of rotation. Define only for angular motion.
YC	Y-center of rotation. Define only for angular motion.
ZC	Z-center of rotation. Define only for angular motion.
AX	Scale factor for acceleration in x-direction
AY	Scale factor for acceleration in y-direction
AZ	Scale factor for acceleration in z-direction
OMX	Scale factor for x-angular velocity or acceleration
OMY	Scale factor for y-angular velocity or acceleration
OMZ	Scale factor for z-angular velocity or acceleration
CID	Coordinate system ID to define acceleration in the local coordinate system. The coordinate (XC, YC, ZC) is defined with respect to the local coordinate system if CID is nonzero. The accelerations, LCID and their scale factors are with respect to CID. EQ.0: global
ANGTYP	Type of body loads due to angular motion EQ.CENT: body load from centrifugal acceleration, $\rho(\omega \times \omega \times r)$ EQ.CORI: body load from Coriolis-type acceleration, $2\rho(\omega \times v)$ EQ.ROTA: body load from rotational acceleration, $\rho(\alpha \times r)$ ,where $\omega$ is the angular velocity, $\alpha$ is the angular acceleration, r is the position vector relative to center of rotation and v is the velocity vector

**Remarks:**

1. Translational base accelerations allow body forces loads to be imposed on a structure. Conceptually, base acceleration may be thought of as accelerating the coordinate system in the direction specified, and, thus, the inertial loads acting on the model are of opposite sign. For example, if a cylinder were fixed to the y-z plane and extended in the positive

x-direction, then a positive x-direction base acceleration would tend to shorten the cylinder, i.e., create forces acting in the negative x-direction.

2. Base accelerations are frequently used to impose gravitational loads during dynamic relaxation to initialize the stresses and displacements. During the analysis, in this latter case, the body forces loads are held constant to simulate gravitational loads. When imposing loads during dynamic relaxation, it is recommended that the load curve slowly ramp up to avoid the excitation of a high frequency response.
3. Body force loads due to the angular motion about an axis are calculated with respect to the deformed configuration. When ANGYP=CENT or CORI, torsional effects which arise from changes in angular velocity are neglected. Such torsional effects can be taken into account by setting ANGTYP=ROTA. The angular velocity is assumed to have the units of radians per unit time, accordingly angular acceleration has the units of radians/time<sup>2</sup>.
4. The body force density is given at a point P of the body by:

$$\mathbf{b} = \rho (\boldsymbol{\omega} \times \boldsymbol{\omega} \times \mathbf{r})$$

where  $\rho$  is the mass density,  $\boldsymbol{\omega}$  is the angular velocity vector, and  $\mathbf{r}$  is a position vector from the origin to point P. Although the angular velocity may vary with time, the effects of angular acceleration are included.

5. Angular velocities are useful for studying transient deformation of spinning three-dimensional objects. Typical applications have included stress initialization during dynamic relaxation where the initial rotational velocities are assigned at the completion of the initialization, and this option ceases to be active.

**\*LOAD\_BODY\_POROUS**

Purpose: Define the effects of porosity on the flow with body-force-like loads applied to the ALE element nodes. Ergun porous flow assumptions are used. This only applies to non-deformable (constant-porosity), fully saturated porous media. This model only works with a non-zero and constant viscosity fluid defined via either \*MAT\_NULL or \*MAT\_ALE\_VISCOUS card.

**For options: X, Y, Z, RX, RY, and RZ.**

	1	2	3	4	5	6	7	8
Variable	SID	SIDTYP	AX	AY	AZ	BX	BY	BZ
Type	I	I	F	F	F	F	F	F
Default	0	0	0.0	0.0	0.0	0.0	0.0	0.0

<u>VARIABLE</u>	<u>DESCRIPTION</u>
SID	Set ID of the ALE fluid part subjected to porous flow condition.
SIDTYP	Set ID type of the SID above. If SIDTYP=0 (default), then the SID=PSID (part set ID). If SIDTYP=1, then SID=PID (part ID).
AX,AY,AZ	Permeability coefficients for viscous terms in global X, Y and Z directions (please see equation below). If $\{[A_x \neq 0] \& [A_y = 0] \& [A_z = 0]\}$ , then an isotropic viscous permeability condition is assumed for the porous medium.
BX,BY,BZ	Passability coefficients for inertia terms in global X, Y and Z directions (please see equation below). If $\{[B_x \neq 0] \& [B_y = 0] \& [B_z = 0]\}$ , then an isotropic inertial permeability condition is assumed for the porous medium.

**Remarks:**

1. Consider the basic general Ergun equation for porous flow in one direction:

$$\frac{\Delta P}{\Delta L} = \frac{\mu}{k_1} V_s + \frac{\rho}{k_2} V_s^2$$

Where

$\rho$  = Fluid density.

$\mu$  = Fluid dynamic viscosity.

$V_s = \frac{4Q}{\pi D^2}$  = Superficial fluid velocity.

$Q$  = Overall volume flow rate (m<sup>3</sup>/s).

$D$  = Porous channel characteristic width (perpendicular to  $\Delta L$ ).

$k_1 = \frac{\varepsilon^3 d_p^2}{150(1-\varepsilon)^2}$  = Viscous parameter

$k_2 = \frac{\varepsilon^3 d_p}{1.75(1-\varepsilon)}$  = Inertial parameter

$\varepsilon$  = Porosity = Pore volume / Total media volume

$d_p$  = Particle diameter

2. The above equation can be generalized into 3 dimensional flows where each component may be written as

$$-\frac{dP}{dx_i} = A_i \mu V_i + B_i \rho |V_i| V_i$$

where  $i = 1, 2, 3$  refers to the global coordinate directions (no summation intended for repeated indices),  $\mu$  is the constant dynamic viscosity,  $\rho$  is the fluid density,  $V_i$  is the fluid velocity components,  $A_i$  is analogous to  $k_1$  above, and  $B_i$  is analogous to  $k_2$  above.

3. If  $B_i = 0$ , the equation is reduced to simple Darcy Law for porous flow (may be good for sand-like flow). For coarse grain (rocks) media, the inertia term will be important and the user needs to input these coefficients.

**\*LOAD\_BRODE**

Purpose: Define Brode function for application of pressure loads due to explosion, see Brode [1970], also see \*LOAD\_SEGMENT, \*LOAD\_SEGMENT\_SET, or \*LOAD\_SHELL.

Card 1            1            2            3            4            5            6            7            8

Variable	YLD	BHT	XBO	YBO	ZBO	TBO	TALC	SFLC
Type	F	F	F	F	F	F	I	I
Default	0.0	0.0	0.0	0.0	0.0	0.0	0	0
Remarks							1	1

Card 2            1            2            3            4            5            6            7            8

Variable	CFL	CFT	CFP					
Type	F	F	F					
Default	0.0	0.0	0.0					

<u>VARIABLE</u>	<u>DESCRIPTION</u>
YLD	Yield (Kt, equivalent tons of TNT).
BHT	Height of burst.
XBO	x-coordinates of Brode origin.
YBO	y-coordinates of Brode origin.
ZBO	z-coordinates of Brode origin.
TBO	Time offset of Brode origin.
TALC	Load curve number giving time of arrival versus range relative to Brode origin (space, time), see *DEFINE_CURVE and remark below.

<u>VARIABLE</u>	<u>DESCRIPTION</u>
SFLC	Load curve number giving yield scaling versus scaled time (time relative to Brode origin divided by $[\text{yield}^{**1/3}]$ ) origin (space, time), see *DEFINE_CURVE and remark below.
CFL	Conversion factor - kft to LS-DYNA length units.
CFT	Conversion factor - milliseconds to LS-DYNA time units.
CFP	Conversion factor - psi to LS-DYNA pressure units.

**Remarks:**

1. If these curves are defined a variable yield is assumed. Both load curves must be specified for the variable yield option. If this option is used, the shock time of arrival is found from the time of arrival curve. The yield used in the Brode formulas is computed by taking the value from the yield scaling curve at the current time/ $[\text{yield}^{**1/3}]$  and multiplying that value by yield.

**\*LOAD\_DENSITY\_DEPTH**

Purpose: Define density versus depth for gravity loading. This option has been occasionally used for analyzing underground and submerged structures where the gravitational preload is important. The purpose of this option is to initialize the hydrostatic pressure field at the integration points in the element.

This card should be only defined once in the input deck.

Card            1            2            3            4            5            6            7            8

Variable	PSID	GC	DIR	LCID				
Type	I	F	I	I				
Default	0	0.0	1	none				
Remarks	1,2			3				

<u>VARIABLE</u>	<u>DESCRIPTION</u>
PSID	Part set ID, see *SET_PART. If a PSID of zero is defined then all parts are initialized.
GC	Gravitational acceleration value.
DIR	Direction of loading: EQ.1: global x, EQ.2: global y, EQ.3: global z.
LCID	Load curve ID defining density versus depth, see *DEFINE_CURVE.

**Remarks:**

- Density versus depth curves are used to initialize hydrostatic pressure due to gravity acting on an overburden material. The hydrostatic pressure acting at a material point at depth, d, is given by:

$$p = - \int_d^{d_{surface}} \rho(z) g dz$$

where  $p$  is pressure,  $d_{surface}$ , is the depth of the surface of the material to be initialized (usually zero),  $\rho(z)$  is the mass density at depth  $z$ , and  $g$  is the acceleration of gravity. This integral is evaluated for each integration point. Depth may be measured along any of the global coordinate axes, and the sign convention of the global coordinate system should be respected. The sign convention of gravity also follows that of the global coordinate system. For example, if the positive  $z$  axis points "up", then gravitational acceleration should be input as a negative number.

2. For this option there is a limit of 12 parts that can be defined by PSID, unless all parts are initialized.
3. Depth is the ordinate of the curve and is input as a descending x, y, or z coordinate value. Density is the abscissa of the curve and must vary (increase) with depth, i.e., an infinite slope is not allowed.



**\*LOAD\_ERODING\_PART\_SET****\*LOAD****\*LOAD\_ERODING\_PART\_SET**

Purpose: Apply a pressure load to the exposed surface composed of solid elements that may erode. .

Card            1            2            3            4            5            6            7            8

Variable	ID	LCID	SF	AT	PSID	BOXID	MEM	ALPHA
Type	I	I	F	F	I	I	I	F
Default	none	none	1	0.0	none	0	50	80

Card 2            1            2            3            4            5            6            7            8

Variable	IFLAG	X	Y	Z	BETA			
Type	I	F	F	F	F			
Default	0	0.0	0.0	0.0	90			

**VARIABLE****DESCRIPTION**

ID	ID number.
LCID	Load curve ID defining pressure as a function of time, see *DEFINE_CURVE.
SF	Scale factor.
AT	Arrival time.
PSID	Part set ID, see *SET_PART.
BOXID	Box ID, see *DEFINE_BOX.
MEM	Extra memory, in percent, to be allocated above the initial memory for storing the new load segments exposed by the erosion.

---

<u>VARIABLE</u>	<u>DESCRIPTION</u>
ALPHA	The maximum angle (in degrees) permitted between the normal of a segment at its centroid and the average normal at its nodes. This angle is used to eliminate interior segments.
IFLAG	Flag for choosing a subset of the exposed surface that is oriented towards a blast or other loading source. The vector from the center of the element to the source location must be within an angle of BETA of the surface normal. If IFLAG>0, then the subset is chosen, otherwise if IFLAG=0, the entire surface is loaded.
X,Y,Z	Optional source location.
BETA	Maximum permitted angle (in degrees) between the surface normal and the vector to the source. The exposed segment is not loaded if the calculated angle is greater than BETA.

**Remarks:**

1. If LCID is input as -1, then the Brode function is used to determine the pressure for the segments, see \*LOAD\_BRODE.
2. If LCID is input as -2, then the ConWep function is used to determine the pressure for the segments, see \*LOAD\_BLAST.
3. The load curve multipliers may be used to increase or decrease the pressure. The time value is not scaled.
4. The activation time, AT, is the time during the solution that the pressure begins to act. Until this time, the pressure is ignored. The function value of the load curves will be evaluated at the offset time given by the difference of the solution time and AT i.e., (solution time-AT). Relative displacements that occur prior to reaching AT are ignored. Only relative displacements that occur after AT are prescribed.
5. For proper evolution of the loaded surface, it is a requirement that DTMIN in \*CONTROL\_TERMINATION be greater than zero and ERODE in \*CONTROL\_TIMESTEP be set to 1.

**\*LOAD\_GRAVITY\_PART\_{OPTION}**

Available options are:

**<BLANK>**

**SET**

Purpose: Define gravity for individual parts. This feature is intended for use with \*LOAD\_STIFFEN\_PART to simulate staged construction. Available for solids and shells, and also beam element types 1, 2, 6, and 9.

Note: This keyword card will be available starting in release 3 of version 971.

Card 1	1	2	3	4	5	6	7	8
--------	---	---	---	---	---	---	---	---

Variable	PID	DOF	LC	ACCEL	LCDR	STGA	STGR	
Type	I	I	I	F	I	I	I	
Default	none	none	none	0	none	0	0	

<u>VARIABLE</u>	<u>DESCRIPTION</u>
PID/PSID	Part ID (or Part Set ID for the _SET option) for application of gravity load
DOF	Direction: enter 1, 2 or 3 for X, Y or Z
LC	Load curve defining factor vs. time (or zero if STGA, STGR are defined)
ACCEL	Acceleration (will be multiplied by factor from curve)
LCDR	Load curve defining factor vs. time during dynamic relaxation
STGA	Construction stage at which part is added (optional)
STGR	Construction stage at which part is removed (optional)

**Remarks:**

There are 3 options for defining how the gravity load on a part varies with time.

1. Curve LC gives factor vs time. This overrides the other methods if LC is non-zero.
2. STGA, STGR refer to stages at which part is added and removed – the stages are defined in \*DEFINE\_CONSTRUCTION\_STAGES. If STGA is zero, the gravity load starts at time zero. If not, it ramps up from the small factor FACT (on \*CONTROL\_STAGED\_CONSTRUCTION) up to full value over the ramp time at the start of stage STGA. If STGR is zero, the gravity load continues until the end of the analysis. If not, it ramps down from full value to FACT over the ramp time at the start of stage STGR.
3. \*DEFINE\_STAGED\_CONSTRUCTION\_PART can be used instead of \*LOAD\_GRAVITY\_PART to define this loading. During initialization, a LOAD\_GRAVITY\_PART card will be created and the effect is the same as using the STGA, STGR method described above; ACCEL is then taken from \*CONTROL\_STAGED\_CONSTRUCTION.

**\*LOAD\_HEAT\_CONTROLLER**

Purpose: Used to define a thermostat control function. The thermostat controls the heat generation within a material by monitoring a remote nodal temperature. Control can be specified as on-off, proportional, integral, or proportional + integral.

Card 1            1            2            3            4            5            6            7            8

Variable	NODE	PID	LOAD	TSET	TYPE	GP	GI	
Type	I	I	F	F	I	F	F	
Default	none	none	none	none	none	none	none	

<u>VARIABLE</u>	<u>DESCRIPTION</u>
NODE	Sensor is located at this node number.
PID	Part ID assigned to the elements modeling the heater or cooler being controlled.
LOAD	Heater output ( $q_0$ ) . [typical units: W/m <sup>3</sup> ]
TSET	Controller set point temperature at the location identified by NODE.
TYPE	Type of control function. EQ.1: on-off EQ.2: proportional + integral
GP	Proportional gain.
GI	Integral gain.

**Remarks:**

The thermostat control function is

$$\dot{q}''' = \dot{q}_0''' + G_P (T_{set} - T_{node}) + G_I \int_{t=0}^t (T_{set} - T_{node}) dt$$

# \*LOAD

# \*LOAD\_HEAT\_GENERATION

## \*LOAD\_HEAT\_GENERATION\_OPTION

Available options include:

**SET**

**SOLID**

Purpose: Define solid elements or solid element set with heat generation.

Card            1            2            3            4            5            6            7            8

Variable	SID	LCID	CMULT	WBLCID	CBLCID	TBLCID		
Type	I	I	F	I	I	I		
Default	none	none	0.	0	0	0		

### VARIABLE

### DESCRIPTION

SID	Solid element set ID or solid element ID, see *SET_SOLID or *ELEMENT_SOLID, respectively.
LCID	Load curve ID for volumetric heat generation rate, $\dot{q}'''$ : GT.0: function versus time, EQ.0: use multiplier value CMULT only, LT.0: function versus temperature.
CMULT	Curve multiplier for $\dot{q}'''$ . Depending on the definition of LCID this value is either used for scaling or for constant heat generation.
WBLCID	Load curve ID defining the blood perfusion rate [e.g., kg/m <sup>3</sup> sec] as a function of time.
CBLCID	Load curve ID defining the blood heat capacity [e.g., J/kg C] as a function of the blood temperature.
TBLCID	Load curve ID defining the blood temperature [e.g., C] as a function of time.

**Remarks:**

1. Heat Generation can be defined by:
  - a) LCID – load curve id
  - b) FID – function id
  - c) a constant baseline value of CMULT
  
2. Rate of heat transfer from blood to tissue =  $W_b C_b (T_b - T)$  [units: J/m<sup>3</sup> sec]

# \*LOAD

# \*LOAD\_MASK

## \*LOAD\_MASK

Purpose: Apply a distributed pressure load over a three-dimensional shell part. The pressure is applied to a subset of elements that are within a fixed global box and lie either outside or inside of a closed curve in space which is projected onto the surface.

Card            1            2            3            4            5            6            7            8

Variable	PID	LCID	VID1	OFF	BOXID	LCIDM	VID2	INOUT
Type	I	I	F	F	I	I	I	I
Default	none	none	1.	0.	0	0	none	0
Remarks	1		2					

Card            1            2            3            4            5            6            7            8

Variable	ICYCLE							
Type	I							
Default	200							
Remarks								

### VARIABLE

### DESCRIPTION

PID	Part ID (PID). This part must consist of 3D shell elements. To use this option with solid element the surface of the solid elements must be covered with null shells. See *MAT_NULL.
LCID	Curve ID defining the pressure time history, see *DEFINE_CURVE.



<u>VARIABLE</u>	<u>DESCRIPTION</u>
VID1	Vector ID normal to the surface on which the applied pressure acts. Positive pressure acts in a direction that is in the opposite direction. This vector may be used if the surface on which the pressure acts is relatively flat. If zero, the pressure load depends on the orientation of the shell elements as shown in Figure 25.3.
OFF	Pressure loads will be discontinued if $ \text{VID1} \cdot \mathbf{n}_{\text{shell}}  < \text{OFF}$ where $\mathbf{n}_{\text{shell}}$ is the normal vector to the shell element.
BOXID	Only elements inside the box with part ID, PID, are considered. If no ID is given all elements of part ID, PID, are included. When the active list of elements are updated, elements outside the box will no longer have pressure applied, i.e., the current configuration is always used.
LCIDM	Curve ID defining the mask. This curve gives (x,y) pairs of points in a local coordinate system defined by the vector ID, VID2. Generally, the curve should form a closed loop, i.e., the first point is identical to the last point, and the curve should be flagged as a DATTYP=1 curve in the *DEFINE_CURVE section. If no curve ID is given, all elements of part ID, PID, are included with the exception of those deleted by the box. The mask works like the trimming option, i.e., see DEFINE_CURVE_TRIM and Figure 13.8.
VID2	Vector ID used to project the masking curve onto the surface of part ID, PID. The origin of this vector determines the origin of the local system that the coordinates of the PID are transformed into prior to determining the pressure distribution in the local system. This curve must be defined if LCIDM is nonzero. See Figure 13.8.
INOUT	If 0, elements whose center falls inside the projected curve are considered. If 1, elements whose center falls outside the projected curve are considered.
ICYCLE	Number of time steps between updating the list of active elements (default=200). The list update can be quite expensive and should be done at a reasonable interval. The default is not be appropriate for all problems.

**Remarks:**

1. The part ID must consist of 3D shell elements.

# \*LOAD

# \*LOAD\_MOTION\_NODE

## \*LOAD\_MOTION\_NODE

Purpose: Apply a concentrated nodal force or moment to a node based on the motion of another node.

Card            1            2            3            4            5            6            7            8

Variable	NODE1	DOF1	LCID	SF	CID1	NODE2	DOF2	CID2
Type	I	I	I	F	I	I	I	I
Default	none	none	none	1.	0	0	0	0
Remarks					1			1

### VARIABLE

### DESCRIPTION

NODE1	Node ID for the concentrated force.
DOF1	Applicable degrees-of-freedom: EQ.1: x-direction of load action, EQ.2: y-direction of load action, EQ.3: z-direction of load action, EQ.4: moment about the x-axis, EQ.5: moment about the y-axis, EQ.6: moment about the z-axis.
LCID	Load curve ID (see *DEFINE_CURVE) or function ID (see *DEFINE_FUNCTION). The applied force is a function of the applicable degree-of-freedom of NODE2.
SF	Load curve scale factor.
CID1	Coordinate system ID (optional), see remark 1 on next page.
NODE2	Node ID for calculating the force.

---

<u>VARIABLE</u>	<u>DESCRIPTION</u>
DOF2	Applicable degrees-of-freedom: EQ. 1: x-coordinate EQ. 2: y-coordinate, EQ. 3: z-coordinate, EQ. 4: x-translational displacement, EQ. 5: y-translational displacement, EQ. 6: z-translational displacement, EQ. 7: rotational displacement about the x-axis, EQ. 8: rotational displacement about the y-axis, EQ. 9: rotational displacement about the z-axis. EQ.10: x-translational velocity, EQ.11: y-translational velocity, EQ.12: z-translational velocity, EQ.13: rotational velocity about the x-axis, EQ.14: rotational velocity about the y-axis, EQ.15: rotational velocity about the z-axis.
CID2	Coordinate system ID (optional), see Remark 1.

**Remarks:**

1. The global coordinate system is the default. The local coordinate system ID's are defined in the \*DEFINE\_COORDINATE\_SYSTEM section.

# \*LOAD

# \*LOAD\_MOVING\_PRESSURE

## \*LOAD\_MOVING\_PRESSURE

Purpose: Apply moving pressure loads to a nondisjoint surface. The pressure loads approximate a jet of high velocity fluid impinging on the surface. Multiple surfaces may be defined each acted on by a set of nozzles.

Card 1            1            2            3            4            5            6            7            8

Variable	LOADID								
Type	I								
Default	none								

**Define the following cards for each nozzle. Include one card for each nozzle**

Cards 2,...,n    1            2            3            4            5            6            7            8

Variable	NODE1	NODE2	LCID	CUTOFF	LCIDT	LCIDD			
Type	I	I	I	F	I	I			
Default	none	none	none	none	0	0			

**The following card defines the surface where the nozzles act.**

Card n+1        1            2            3            4            5            6            7            8

Variable	ID	IDTYPE	NIP						
Type	I	I	I						
Default	none	none	3x3						

### VARIABLE

### DESCRIPTION

LOADID

Loading ID.

---

<b>VARIABLE</b>	<b>DESCRIPTION</b>
NODE1	Node located at the origin of the nozzle.
NODE2	Node located at the head of the nozzle
LCID	Load curve or function (see *DEFINE_FUNCTION) ID defining pressure versus radial distance from the center of the jet.
CUTOFF	Outer radius of jet. The pressure acting outside this radius is set to zero.
LCIDT	Load curve or function (see *DEFINE_FUNCTION) ID, which scales the pressure as a function of time. If a load curve isn't specified, the scale factor defaults to 1.0.
LCIDD	Load curve or function (see *DEFINE_FUNCTION) ID, which scales the pressure as a function of distance from the nozzle. If a load curve isn't specified, the scale factor defaults to 1.0.
ID	Segment set ID, shell element set ID, part set ID, or part ID. See IDT below.
IDT	Slave segment or node set type. The type must correlate with the number specified for SSID: EQ.0: segment set ID for surface-to-surface contact, EQ.1: shell element set ID for surface-to-surface contact, EQ.2: part set ID, EQ.3: part ID,
NIP	Number of integration in segment used to compute pressure loads.

# \*LOAD

\*LOAD\_NODE

## \*LOAD\_NODE\_OPTION

Available options include:

**POINT**

**SET**

Purpose: Apply a concentrated nodal force to a node or a set of nodes.

Card                    1                    2                    3                    4                    5                    6                    7                    8

Variable	NODE/NSID	DOF	LCID	SF	CID	M1	M2	M3
Type	I	I	I	F	I	I	I	I
Default	none	none	none	1.	0	0	0	0
Remarks					1	2		

### VARIABLE

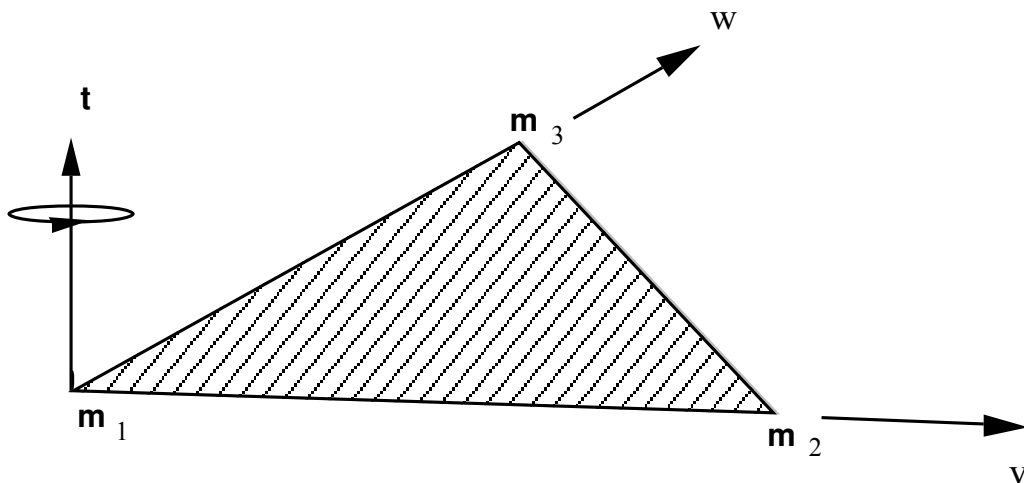
### DESCRIPTION

NODE/NSID	Node ID or nodal set ID (NSID), see *SET_NODE_OPTION.
DOF	Applicable degrees-of-freedom: EQ.1: x-direction of load action, EQ.2: y-direction of load action, EQ.3: z-direction of load action, EQ.4: follower force, see remark 2 on next page, EQ.5: moment about the x-axis, EQ.6: moment about the y-axis, EQ.7: moment about the z-axis. EQ.8: follower moment
LCID	Load curve ID (see *DEFINE_CURVE) or function ID (see *DEFINE_FUNCTION).
SF	Load curve scale factor.
CID	Coordinate system ID (optional), see remark 1 on next page.
M1	Node 1 ID. Only necessary if DOF.EQ.4 or 8, see remark 2 below.

VARIABLE	DESCRIPTION
M2	Node 2 ID. Only necessary if DOF.EQ.4 or 8, see remark 2 below.
M3	Node 3 ID. Only necessary if DOF.EQ.4 or 8, see remark 2 below.

**Remarks:**

1. The global coordinate system is the default. The local coordinate system ID's are defined in the \*DEFINE\_COORDINATE\_SYSTEM section.
2. Nodes  $M_1$ ,  $M_2$ ,  $M_3$  must be defined for a follower force. A positive follower force acts normal to the plane defined by these nodes, and a positive follower moment puts a counterclockwise torque about the t-axis. These actions are depicted in Figure 25.2.
3. For shell formulations 14 and 15, the axisymmetric solid elements with area and volume weighting, respectively, the specified nodal load is per unit length (type14) and per radian (type 15).
4. The function defined by LCID has 7 arguments: time, the 3 current coordinates, and the 3 reference coordinates. A function that applies a force proportional to the distance from the initial coordinates would be  $f(t, x, y, z, x_0, y_0, z_0) = -10.*\text{sqrt}((x-x_0)^2 + (y-y_0)^2 + (z-z_0)^2)$ .



**Figure 25.2.** Follower force and moment acting on a plane defined by nodes  $m_1$ ,  $m_2$ , and  $m_3$ . In this case, the load is applied to node  $m_1$ ; i.e.,  $m=m_1$ . A positive force acts in the positive  $t$ -direction, and a positive moment puts a counterclockwise torque about the normal vector. The positive  $t$ -direction is found by the cross product  $t = v \times w$  where  $v$  and  $w$  are vectors as shown.





**\*LOAD\_REMOVE\_PART\_{OPTION}**

Available options include:

**<BLANK>**

**SET**

Purpose: Delete the elements of a part in a staged construction simulation. Shock effects are prevented by gradually reducing the stresses prior to deletion. Available only for solid and shell elements.

Note: This keyword card will be available starting in release 3 of version 971.

Card	1	2	3	4	5	6	7	8
------	---	---	---	---	---	---	---	---

Variable	PID/PSID	TIME0	TIME1	STGR				
Type	I	F	F	I				
Default	none	0	0	0				

<u>VARIABLE</u>	<u>DESCRIPTION</u>
PID	Part ID (or Part Set ID for the _SET option) for deletion
TIME0	Time at which stress reduction starts
TIME1	Time at which stresses become zero and elements are deleted
STGR	Construction stage at which part is removed (optional)

**Remarks:**

There are 3 methods of defining the part removal time:

1. TIME0, TIME1 override all the other methods if non-zero
2. STGR refers to the stage at which the part is removed – the stages are defined in \*DEFINE\_CONSTRUCTION\_STAGES. This is equivalent to setting TIME0 and TIME1 equal to the start and end of the ramp time at the beginning of stage STGR.

3. \*DEFINE\_STAGED\_CONSTRUCTION\_PART can be used instead of \*LOAD\_REMOVE\_PART to define this loading. During initialization, a STIFFEN\_PART card will be created and the effect is the same as using the STGA, STGR method described above.

**\*LOAD\_RIGID\_BODY**

Purpose: Apply a concentrated nodal force to a rigid body. The force is applied at the center of mass or a moment is applied around a global axis. As an option, local axes can be defined for force or moment directions.

Card            1            2            3            4            5            6            7            8

Variable	PID	DOF	LCID	SF	CID	M1	M2	M3
Type	I	I	I	F	I	I	I	I
Default	none	none	none	1.	0	0	0	0
Remark					1	2		

**VARIABLE****DESCRIPTION**

PID	Part ID of the rigid body, see *PART_OPTION.
DOF	Applicable degrees-of-freedom: EQ.1: x-direction of load action, EQ.2: y-direction of load action, EQ.3: z-direction of load action, EQ.4: follower force, see Remark 2, EQ.5: moment about the x-axis, EQ.6: moment about the y-axis, EQ.7: moment about the z-axis. EQ.8: follower moment, see Remark 2.
LCID	Load curve ID (see *DEFINE_CURVE) or function ID (see *DEFINE_FUNCTION). GT.0: force as a function of time, LT.0: force as a function of the absolute value of the rigid body displacement. This option only applies to load curves.
SF	Load curve scale factor
CID	Coordinate system ID
M1	Node 1 ID. Only necessary if DOF.EQ.4 or 8, see Remark 2.
M2	Node 2 ID. Only necessary if DOF.EQ.4 or 8, see Remark 2.

VARIABLE	DESCRIPTION
M3	Node 3 ID. Only necessary if DOF.EQ.4 or 8, see Remark 2.

**Remarks:**

1. The global coordinate system is the default. The local coordinate system ID's are defined in the \*DEFINE\_COORDINATE\_SYSTEM section. This local axis is fixed in inertial space, i.e., it does not move with the rigid body.
2. Nodes  $M_1, M_2, M_3$  must be defined for a follower force or moment. The follower force acts normal to the plane defined by these nodes as depicted in Figure 25.2. The positive  $t$ -direction is found by the cross product  $t = v \times w$  where  $v$  and  $w$  are vectors as shown. The follower force is applied at the center of mass. A positive follower moment puts a counterclockwise torque about the  $t$ -axis.
3. When LCID defines a function, the function has seven arguments: time, the 3 current coordinates for the center of mass, and the 3 reference coordinates. A function that applies a force proportional to the distance from the initial coordinates would be  $f(t, x, y, z, x0, y0, z0) = -10.*sqrt((x-x0)*(x-x0) + (y-y0)*(y-y0) + (z-z0)*(z-z0))$ .

```

$$$$$$$$$$$$$$$$$$$$$$$$$$$$$$$$$$$$$$$$$$$$$$$$$$$$$$$$$$$$$$$$$$$$$$$$$$$$$$$$
$
$$$$  *LOAD_RIGID_BODY
$
$$$$$$$$$$$$$$$$$$$$$$$$$$$$$$$$$$$$$$$$$$$$$$$$$$$$$$$$$$$$$$$$$$$$$$$$$$$$$$$$
$
$ From a sheet metal forming example. A blank is hit by a punch, a binder is
$ used to hold the blank on its sides. The rigid holder (part 27) is held
$ against the blank using a load applied to the cg of the holder.
$
$ The direction of the load is in the y-direction (dof=2) but is scaled
$ by sf = -1 so that the load is in the correct direction. The load
$ is defined by load curve 12.
$
*LOAD_RIGID_BODY
$
$.>...1...>...2...>...3...>...4...>...5...>...6...>...7...>...8
$   pid       dof       lcid       sf         cid         m1         m2         m3
$     27         2         12         -1.0
$
$

```





**Extra card if N5 is not zero**

Card            1            2            3            4            5            6            7            8

Variable	N6	N7	N8					
Type	I	I	I					
Default	none	none	none					

<u>VARIABLE</u>	<u>DESCRIPTION</u>
ID	Loading ID
HEADING	A description of the loading.
LCID	Load curve ID (see *DEFINE_CURVE) or function ID (see *DEFINE_FUNCTION).
SF	Load curve scale factor
AT	Arrival time for pressure or birth time of pressure.
N1	Node ID
N2	Node ID
N3	Node ID. Repeat N2 for two-dimensional geometries.
N4	Node ID. Repeat N2 for two-dimensional geometries or repeat N3 for 3-node triangular segments..
N5	Optional mid-side node ID (see Fig. 25.3).
N6	Optional mid-side node ID (see Fig. 25.3).
N7	Optional mid-side node ID (see Fig. 25.3).
N8	Optional mid-side node ID (see Fig. 25.3).









Card 3            1            2            3            4            5            6            7            8

Variable	P1	P2	P3	P4	P5	P6	P7	P8
Type	F	F	F	F	F	F	F	F
Default	none	none	none	none	none	none	none	none

<u>VARIABLE</u>	<u>DESCRIPTION</u>
-----------------	--------------------

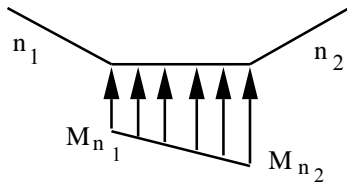
ID	Loading ID
HEADING	A description of the loading.
LCID	Load curve ID (see *DEFINE_CURVE) or function ID (see *DEFINE_FUNCTION). The seven arguments for the function are current time minus the birth time, the current x, y, and z coordinates, and the initial x, y, and z coordinates.
SF	Load curve scale factor
AT	Arrival/birth time for the traction load.
DT	Death time for the traction load.
CID	Coordinate system ID
V1,V2,V3	Vector direction cosines referenced to coordinate system CID to define the direction of the traction loading.
N1	Node ID
N2	Node ID
N3	Node ID. Repeat N2 for two-dimensional geometries.
N4	Node ID. Repeat N2 for two-dimensional geometries or repeat N3 for 3-node triangular segments.
N5	Optional mid-side node ID (see Fig. 25.3).
N6	Optional mid-side node ID (see Fig. 25.3).
N7	Optional mid-side node ID (see Fig. 25.3).

<u>VARIABLE</u>	<u>DESCRIPTION</u>
N8	Optional mid-side node ID (see Fig. 25.3).
P1	Scale factor at node ID, N1.
P2	Scale factor at node ID, N2.
P3	Scale factor at node ID, N3.
P4	Scale factor at node ID, N4.
P5	Scale factor at node ID, N5.
P6	Scale factor at node ID, N6.
P7	Scale factor at node ID, N7.
P8	Scale factor at node ID, N8.

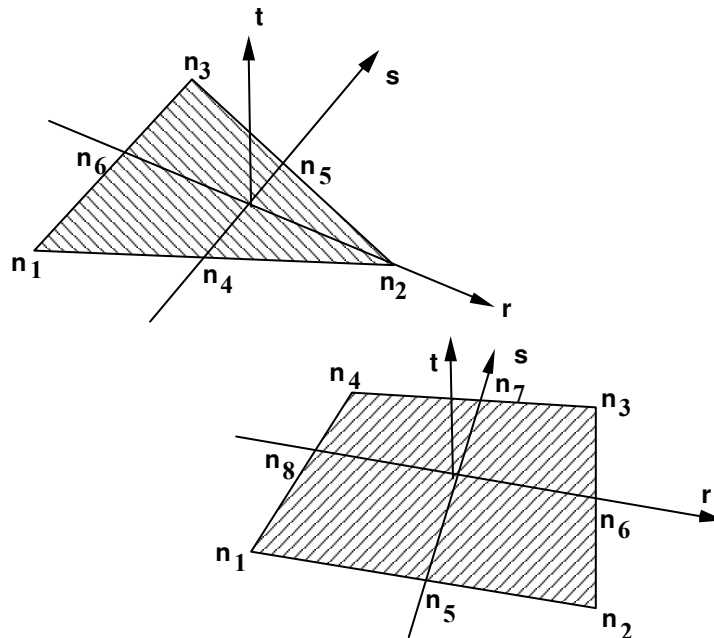


**Remarks:**

1. If LCID is input as -1, then the Brode function is used to determine pressure for the segment set, also see \*LOAD\_BRODE. If LCID is input as -2, then the ConWep function is used to determine the pressure for the segments, see \*LOAD\_BLAST.
2. The load curve multipliers may be used to increase or decrease the pressure. The time value is not scaled.
3. The activation time, AT, is the time during the solution that the pressure begins to act. Until this time, the pressure is ignored. The function value of the load curves will be evaluated at the offset time given by the difference of the solution time and AT i.e., (solution time-AT). Relative displacements that occur prior to reaching AT are ignored. Only relative displacements that occur after AT are prescribed.



2-Dimensional Definition for axisymmetric, plane stress, and plane strain geometries



**Figure 25.3.** Nodal numbering for pressure cards. Positive pressure acts in the negative  $t$ -direction. For two-dimensional problems repeat the second node for the third and fourth nodes in the segment definitions.

**\*LOAD\_SEGMENT\_SET\_ANGLE**

Purpose: Apply the traction load over a segment set that is dependent on the orientation of a vector. An example application is applying a pressure to a cylinder as a function of the crank angle in an automobile engine. The pressure and node numbering convention follows Figure 25.3.

Card 1            1            2            3            4            5            6            7            8

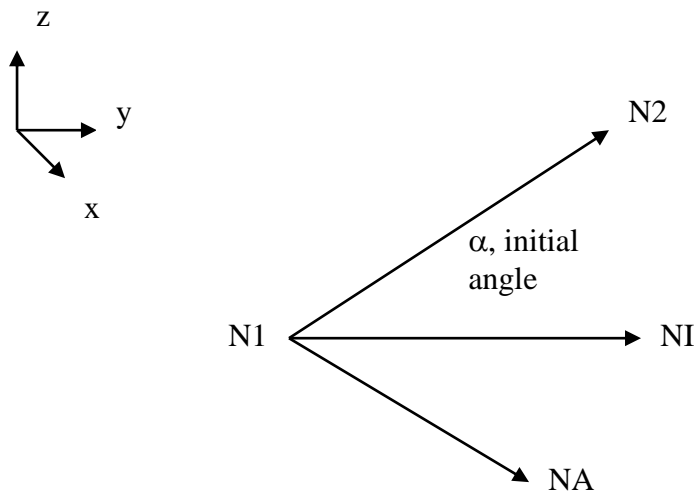
Variable	ID	IDSS	LCID	SCALE	IOPTP	IOPTD		
Type	I	I	I	F	I	I		
Default	none	none	none	1.	0	0		

Card 2            1            2            3            4            5            6            7            8

Variable	N1	N2	NA	NI				
Type	I	I	I	I				
Default	none	none	none	none				

<u>VARIABLE</u>	<u>DESCRIPTION</u>
ID	Loading ID
IDSS	Segment set ID.
LCID	Load curve or function ID defining the traction as a function of the angle. If IOPT=0 below, define the abscissa between 0 and 2π radians or 0 and 360 degrees if IOPD=1.
SCALE	Scale factor on value of the load curve or function.

<b>VARIABLE</b>	<b>DESCRIPTION</b>
IOPTP	Flag for periodicity. The default (IOPTP=0) requires the load curve to be defined between 0 and $2\pi$ . This is useful, for example, for modeling an engine that is running at a steady state since each rotation will experience the same loading. To model a transient response, IOPTP=1 uses a load curve defined over the full range of angles, permitting a different response on the second and subsequent revolutions.
IOPTD	Flag for specifying if the load curve or function argument is in radians (IOPTD=0, the default) or degrees (IOPTD=1).
N1	The node specifying the tail of the rotating vector.
N2	The node specifying the head of the rotating vector.
NA	The node specifying the head of the vector defining the axis of rotation. The node N1 specifies the tail.
NI	The node specifying the orientation of the vector at an angle of zero. If the initial angle is zero, NI should be equal to N2.







<b>VARIABLE</b>	<b>DESCRIPTION</b>
HEADING	A description of the loading.
SSID	Segment set ID.
LCID	Load curve ID (see *DEFINE_CURVE) or function ID (see *DEFINE_FUNCTION). The seven arguments for the function are current time minus the birth time, the current x, y, and z coordinates, and the initial x, y, and z coordinates.
SF	Load curve scale factor
AT	Arrival/birth time for pressure.
DT	Death time for pressure.
CID	Coordinate system ID
V1,V2,V3	Vector direction cosines referenced to coordinate system CID to define the direction of the traction loading.



# \*LOAD

\*LOAD\_SEISMIC\_SSI

Card 1 for OPTION1=POINT:

Card format (i8,3e16.0,3i8)

Card 1            1            2            3            4            5            6            7            8            9            10

Variable	SSID	XP	YP	ZP	GMX	GMY	GMZ
Type	I	F	F	F	I	I	I
Default	none	0.	0.	0.	none	none	None

Card 2:

Card format (e10.0,i10,2e10.0,2i10)

Card 2            1            2            3            4            5            6            7            8

Variable	SF	CID	BIRTH	DEATH	ISG	IGM		
Type	F	I	F	F	I	I		
Default	1.	0	0.	1.E+28	0	0		

## VARIABLE

## DESCRIPTION

ID	Optional ID. This ID does not need to be unique.
HEADING	An optional descriptor for the given ID.
SSID	Soil-structure interface ID.
typeID	Node ID (NID in *NODE) or nodal set ID (SID in *SET_NODE).
XP	x coordinate of ground motion location on soil-structure interface.
YP	y coordinate of ground motion location on soil-structure interface.
ZP	z coordinate of ground motion location on soil-structure interface.
GMX	Acceleration load curve or ground motion ID for motion in the (local) x-direction.

---

<u>VARIABLE</u>	<u>DESCRIPTION</u>
GMX	Acceleration load curve or ground motion ID for motion in the (local) x-direction.
GMZ	Acceleration load curve or ground motion ID for motion in the (local) z-direction.
SF	Ground motion scale factor. (default=1.0)
CID	Coordinate system ID, see *DEFINE_COORDINATE_SYSTEM.
BIRTH	Time at which specified ground motion is activated.
DEATH	Time at which specified ground motion is removed: EQ.0.0: default set to $10^{28}$
ISG	Definition of soil-structure interface: EQ.0: SSID is ID for soil-structure interface defined by *INTERFACE_SSI_ID for non-matching mesh between soil and structure. EQ.1: SSID is segment set ID identifying soil-structure interface for merged meshes between soil and structure.
IGM	Specification of ground motions GMX, GMY, GMZ: EQ.0: ground motions are specified as acceleration load curves. See *DEFINE_CURVE EQ.1: Both ground accelerations and velocities specified using *DEFINE_GROUND_MOTION.

**Remarks:**

1. The ground motion at any node on a soil-structure interface is computed as follows:
  - (a) If the node coincides with a location where ground motion is specified, that ground motion is used for that node.
  - (b) If the node does not coincide with a location where ground motion is specified, the ground motion at that node along a particular degree-of-freedom is taken as a weighted average of all the ground motions specified on the interface along that degree-of-freedom, where the weights are inversely proportional to the distance of the node from the ground motion location.
2. Multiple ground motions specified at the same location are added together to obtain the resultant ground motion at that location.

3. Spatially-uniform ground motion may be specified on a soil-structure interface by specifying the ground motion at only one location on that interface. Specifying the ground motion at more than one point on a soil-structure interface results in spatially-varying ground motion on that interface.

\*LOAD\_SHELL\_OPTION1\_{OPTION2}

Available options for OPTION1 include:

**ELEMENT**

**SET**

Available options for OPTION2 include:

**ID**

To define an ID for the segment loading.

If the ID is defined an additional card is required.

Purpose: Apply the distributed pressure load over one shell element or shell element set. The numbering of the shell nodal connectivities must follow the right hand rule with positive pressure acting in the negative t-direction. See Figure 25.3. This option applies to the three-dimensional shell elements only.

**ID Card - Required if the option ID is active on the keyword card.**

Optional                1    2-8

Variable	ID	HEADING						
Type	I	A70						

Card 1                1                2                3                4                5                6                7                8

Variable	EID/ESID	LCID	SF	AT				
Type	I	I	F	F				
Default	none	none	1.	0.				
Remarks	1	1	2					

<u>VARIABLE</u>	<u>DESCRIPTION</u>
EID/ESID	Shell ID (SID) or shell set ID (SSID), see *ELEMENT_SHELL or *SET_SHELL.
LCID	Load curve ID, see *DEFINE_CURVE.
SF	Load curve scale factor
AT	Arrival time for pressure or birth time of pressure.

### Remarks:

1. If LCID is input as -1, then the Brode function is used to determine the pressure for the segments, see also \*LOAD\_BRODE.
2. If LCID is input as -2, then the ConWep function is used to determine the pressure for the segments, see \*LOAD\_BLAST.
3. The load curve multipliers may be used to increase or decrease the pressure. The time value is not scaled.

```

$$$$$$$$$$$$$$$$$$$$$$$$$$$$$$$$$$$$$$$$$$$$$$$$$$$$$$$$$$$$$$$$$$$$$$$$$$$$$$$$$$$$
$
$$$$ *LOAD_SHELL_ELEMENT
$
$$$$$$$$$$$$$$$$$$$$$$$$$$$$$$$$$$$$$$$$$$$$$$$$$$$$$$$$$$$$$$$$$$$$$$$$$$$$$$$$$$$$
$
$ From a sheet metal forming example. A blank is hit by a punch, a holder is
$ used to hold the blank on its sides. All shells on the holder are given a
$ pressure boundary condition to clamp down on the blank. The pressure
$ follows load curve 3, but is scaled by -1 so that it applies the load in the
$ correct direction. The load starts at zero, but quickly rises to 5 MPa
$ after 0.001 sec. (Units of this model are in: ton, mm, s, N, MPa, N-mm)
$

```





**\*LOAD\_SPCFORC**

Purpose: When used in a full-deck restart run, this card will apply the SPC constraint forces from the initial run on the corresponding degrees of freedom in the current run. This is useful when modeling unbounded domains using a non-reflecting boundary while incorporating static stresses computed in the initial run: the fixed constraints on the outer boundary in the initial static analysis are removed in the transient analysis and replaced by equivalent static forces.

While **\*BOUNDARY\_NON\_REFLECTING** acts similarly if dynamic relaxation is used for the static analysis, this approach works for any method used to preload the model.

No parameters are necessary for this card.

\*LOAD\_SSA

Purpose: The Sub-Sea Analysis capability allows a simple way of loading the structure to account for the effects of the primary explosion and the subsequent bubble oscillations.

Card 1            1            2            3            4            5            6            7            8

Variable	VS	DS	REFL	ZB	ZSURF	FPSID	PSID	NPTS
Type	F	F	F	F	F	I	I	I
Default	none	none	0.	0.	0.	0	0	1

**Define two cards for each explosive charge. This input is terminated by the next “\*” keyword card.**

Card 1            1            2            3            4            5            6            7            8

Variable	A	ALPHA	GAMMA	KTHETA	KAPPA			
Type	F	F	F	F	F			
Default	none	none	none	none	none			

Card 2            1            2            3            4            5            6            7            8

Variable	XS	YS	ZS	W	TDELY	RAD	CZ	
Type	F	F	F	F	F	F	F	
Default	none	none	none	none	none	none	none	

<u>VARIABLE</u>	<u>DESCRIPTION</u>
-----------------	--------------------

VS	Sound speed in fluid
----	----------------------

<b>VARIABLE</b>	<b>DESCRIPTION</b>
DS	Density of fluid
REFL	Consider reflections from sea floor. EQ.0: off EQ.1: on
ZB	Z coordinate of sea floor if REFL=1, otherwise, not used.
ZSURF	Z coordinate of sea surface
FPSID	Part set ID of parts subject to flood control. Use the *PART_SET_COLUMN option where the parameters A1 and A2 must be defined as follows: Parameter A1: Flooding status: EQ.1.0: Fluid on both sides. EQ.2.0: Fluid outside, air inside. EQ.3.0: Air outside, fluid inside. EQ.4.0: Material or part is ignored. Parameter A2: Tubular outer diameter of beam elements. For shell elements this input must be greater than zero for loading.
PSID	Part IDs of parts defining the wet surface. The elements defining these parts must have their outward normals pointing into the fluid. See Figure 25.4. EQ.0: all parts are included. GT.0: define NPIDS part ID's below.
NPTS	Number of integration points for computing pressure (1 or 4)
A	Shock pressure parameter
ALPHA	$\alpha$ , shock pressure parameter
GAMMA	$\gamma$ , time constant parameter
KTHETA	$K_\theta$ , time constant parameter
KAPPA	$\kappa$ , ratio of specific heat capacities
XS	X coordinate of charge
YS	Y coordinate of charge
ZS	Z coordinate of charge

---

<u>VARIABLE</u>	<u>DESCRIPTION</u>
W	Weight of charge
TDELY	Time delay before charge detonates
RAD	Charge radius
CZ	Water depth

**Remarks:**

The pressure history of the primary shockwave at a point in space through which a detonation wave passes is given as:

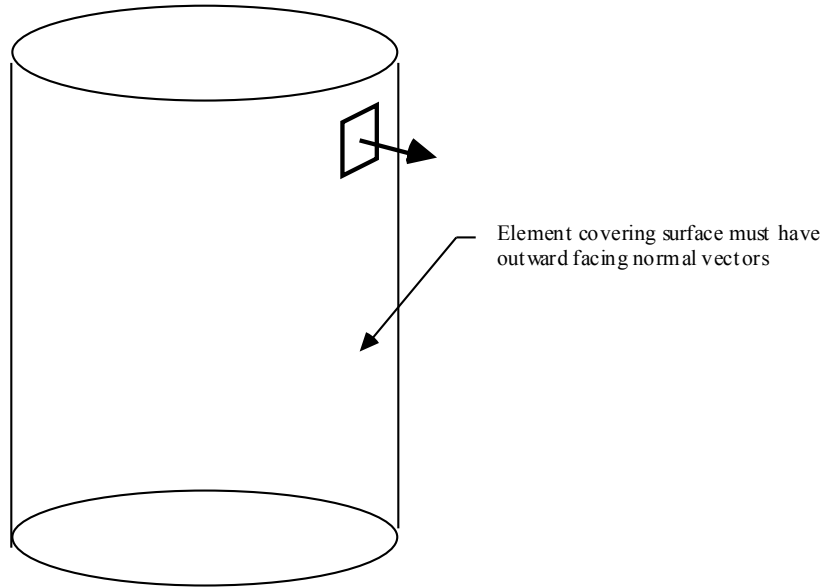
$$P(t) = P_m e^{-\frac{t}{\theta}}$$

where  $P_m$  and the time constant  $\theta$  below are functions of the type and weight  $W$  of the explosive charge and the distance  $Q$  from the charge.

$$P_{\text{peak}} = A \left[ \frac{W^{1/3}}{Q} \right]^\alpha$$

$$\theta = K_\theta W^{1/3} \left[ \frac{W^{1/3}}{Q} \right]^\gamma$$

where  $A$ ,  $\alpha$ ,  $\gamma$ , and  $K_\theta$  are constants for the explosive being used.



**Figure 25.4.** The shell elements interacting with the fluid must be numbered such that their outward normal vector points into the fluid media.

**\*LOAD\_STEADY\_STATE\_ROLLING**

Steady state rolling analysis is a generalization of \*LOAD\_BODY, allowing the user to apply body loads to part sets due to translational and rotational accelerations in a manner that is more general than the \*LOAD\_BODY capability. The \*LOAD\_STEAD\_STATE\_ROLLING may be invoked an arbitrary number of times in the problem as long as no part has the option applied more than once and they can be applied to arbitrary meshes (i.e., axisymmetric spun meshes aren't required).

Card 1            1            2            3            4            5            6            7            8

Variable	ID	PSID						
Type	I	I						
Default	none	none						

Card 2            1            2            3            4            5            6            7            8

Variable	N1	N2	LCD1	LCD1R				
Type	I	I	I	I				
Default	0	0	0	0				

Card 3            1            2            3            4            5            6            7            8

Variable	N3	N4	LCD2	LCD2R				
Type 4	I	I	I	I				
Default	0	0	0	0				

# \*LOAD

# \*LOAD\_STEADY\_STATE\_ROLLING

Card 4            1            2            3            4            5            6            7            8

Variable	N5	N6	LCD3	LCD3R				
Type	I	I	I	I				
Default	0	0	0	0				

## VARIABLE

## DESCRIPTION

ID	ID
PSID	Part set ID
N1	Node 1 defining rotational axis
N2	Node 2 defining rotational axis
LCD1	Load curve defining angular velocity around rotational axis.
LCD1R	Optional load curve defining angular velocity around rotational axis for dynamic relaxation. LCD1 is used during dynamic relaxation if LCD1R isn't defined.
N3	Node 3 defining turning axis
N4	Node 4 defining turning axis
LCD2	Load curve defining angular velocity around turning axis.
LCD2R	Optional load curve defining angular velocity around turning axis for dynamic relaxation. LCD2 is used during dynamic relaxation if LCD2R isn't defined.
N5	Node 5 defining translational direction
N6	Node 6 defining translational direction
LCD3	Load curve defining translational velocity in translational direction.
LCD3R	Optional load curve defining translational velocity in translational direction. LCD3 is used during dynamic relaxation if LCD3R isn't defined.



**Remarks:**

The steady state rolling capability adds inertial body loads in terms of a moving reference defined by the user input. The current coordinates are defined in terms of the displacement,  $u$ , and the moving reference frame,  $Y$ ,

$$x_{SSR} = u + Y \quad \dot{x}_{SSR} = \dot{u} + \dot{Y} \quad \ddot{x}_{SSR} = \ddot{u} + \ddot{Y}$$

$$Y = R(\omega_2 t) \left[ R(\omega_1 t) (X - X_0) - X_c \right] + Y_T(t)$$

where  $R$  is the rotation matrix obtained by integrating the appropriate angular velocity, the magnitude of the angular velocities  $\omega_1$  and  $\omega_2$  are defined by load curves LCD1 and LCD2 respectively, and the directions are defined by the current coordinates of the node pairs N1-N2 and N3-N4. The velocity corresponding to the translational term,  $Y_T(t)$ , is defined in magnitude by LCD3 and in direction by the node pair N5-N6. The initial coordinates of the nodes are  $X$ ,  $X_0$  is the initial coordinate vector of node N1 and  $X_c$  is the initial coordinate vector of node N3. If data defining an angular velocity is not specified, the velocity is defaulted to zero, and  $R$  is the identity matrix. In a similar manner, if the translational velocity isn't specified, it is defaulted to zero.

This capability is useful for initializing the stresses and velocity of tires during dynamic relaxation, and rolling processes in manufacturing. It is available for solid formulations 1, 2, 10, 13, and 15, and for shell formulations 2, 4, 5, 6, 16, 25, 26, and 27. It is not available for beams and tshells. It is available for implicit and explicit simulations and is invoked for dynamic relaxation by specifying that the load curves are used during dynamic relaxation. At the end of the dynamic relaxation, the velocities of the parts are set to  $\dot{x}_{SSR}$  and the remaining parts are initialized according to the input file.

Users must ensure that the appropriate load curves are turned on during the relaxation process, and if implicit dynamic relaxation is used, that sufficient constraints are applied during the initialization to remove any rigid body motion and that they are removed at the end of the dynamic relaxation. The implicit iteration convergence rate is often improved by adding the geometric stiffness matrix using \*CONTROL\_IMPLICIT\_GENERAL. A consistent tangent matrix is available by using \*CONTROL\_IMPLICIT\_GENERAL, and while it improves the convergence rate with problems with small strains, it is often unstable for problems with large strains. The \*CONTROL\_STEADY\_STATE\_ROLLING options should be used to ramp up the frictional forces to obtain smooth solutions and good convergence rates.

To obtain the free-rolling angular velocity, the tire should be first inflated, then brought into contact with the road while the frictional force is ramped up with a load curve and a large value of SCL\_K specified in \*CONTROL\_STEADY\_STATE\_ROLLING. The angular velocity of the tire is then slowly varied over a range that covers the free rolling velocity. The free rolling velocity is obtained when either the frictional force in the direction of rolling or the moment about the tire axis is near zero. For a tire with an initial radius of  $R$  and a translational velocity

of  $V$ , the approximate value for the free rolling value of the rolling velocity is  $\omega = \frac{V}{(1 + \epsilon)R}$ ,

where  $\varepsilon$  is the hoop strain of the rolling tire. For a first guess, the hoop strain can be set to 0.0, and the rolling velocity will be within 10% of the actual value. After the first calculation, a smaller range bracketing the free rolling velocity should be used in a second calculation to refine the free rolling velocity. An accurate value of the free rolling velocity is necessary for subsequent analyses, such as varying the slip angle of the tire.

A time varying slip angle can be specified by moving one of the nodes defining the direction vector of the translational velocity. To check that the stiffness scale factor in **\*CONTROL\_STEADY\_STATE\_ROLLING** is high enough, a complete cycle from a zero slip angle to a maximum value, then back to zero, should be performed. If the loading and unloading values are reasonably close, then the stiffness scale factor is adequate.

**\*LOAD\_STIFFEN\_PART\_{OPTION}**

Available options include:

**<BLANK>**

**SET**

Purpose: Staged construction. Available for solid, shell, and beam elements.

Note: This keyword card is available starting in release 3 of version 971.

Card 1	1	2	3	4	5	6	7	8
--------	---	---	---	---	---	---	---	---

Variable	PID/PSID	LC	(blank)	STGA	STGR			
Type	I	I		I	I			
Default	none	0		0	0			

<u>VARIABLE</u>	<u>DESCRIPTION</u>
PID	Part ID (or Part Set ID for the _SET option)
LC	Load curve defining factor vs. time
STGA	Construction stage at which part is added (optional)
STGR	Construction stage at which part is removed (optional)

**Remarks:**

- In many cases it is more convenient to use \*DEFINE\_STAGED\_CONSTRUCTION\_PART – this card creates \*LOAD\_STIFFEN\_PART data automatically.
- For parts that are initially present but are excavated (removed) during the analysis, the stiffness factor starts at 1.0. During the excavation time, it ramps down to a small value such as 1.0E-6. The excavation time should be sufficiently long to avoid introducing shock or dynamic effects. For parts that are introduced during the construction, e.g. retaining walls, the elements are initially present in the model but the factor is set to a low value such as 1.0e-6. During the construction time the factor should be ramped up to 1.0. The construction time should be sufficiently long to avoid shock or dynamic effects. A

factor that ramps up from 1.0E-6 to 1.0, then reduces back to 1.0E-6, can be used for temporary retaining walls, props, etc.

3. When the factor is increasing, it applies only to the stiffness and strength of the material in response to subsequent strain increments, not to any existing stresses.
4. When the factor is decreasing, it applies also to existing stresses as well as to the stiffness and strength.
5. This feature works with all material models when used only to reduce the stiffness (e.g. parts that are excavated, not parts that are added during construction). It works for most material types in all other cases, except those few materials that re-calculate stresses each time step from total strains (elastic, SOIL\_BRICK, rubber models, orthotropic elastic, fabric, etc). There is no error check at present to detect STIFFEN\_PART being used with an inappropriate material model. Symptoms of resulting problems would include non-physical large stresses when a part stiffens, due to the accumulated strains in the “dormant” material since the start of the analysis.
6. This feature is generally used with \*LOAD\_GRAVITY\_PART. The same curve is often used for the stiffness factor and the gravity factor.
7. There are 3 methods of defining the factor-versus-time:
  1. LC overrides all the other methods if non-zero
  2. STGA, STGR refer to stages at which the part is added and removed – the stages are defined in \*DEFINE\_CONSTRUCTION\_STAGES. If STGA is zero, the part has full stiffness at time zero. If not, it ramps up from the small factor FACT (on \*CONTROL\_STAGED\_CONSTRUCTION) up to 1.0 over the ramp time at the start of stage STGA. If STGR is zero, the stiffness factor continues at 1.0 until the end of the analysis. If not, it ramps down from 1.0 to FACT over the ramp time at the start of stage STGR.
  3. \*DEFINE\_STAGED\_CONSTRUCTION\_PART can be used instead of \*LOAD\_STIFFEN\_PART to define this loading. During initialization, a \*LOAD\_STIFFEN\_PART card will be created and the effect is the same as using the STGA, STGR method described above.

**\*LOAD\_SUPERPLASTIC\_FORMING**

Purpose: Perform superplastic forming (SPF) analyses. This option can be applied to both solid and shell elements. The pressure loading controlled by the load curve ID given below is scaled to maintain a constant maximum strain rate.

This option must be used with material model 64, \*MAT\_RATE\_SENSITIVE\_POWERLAW\_PLASTICITY, for strain rate sensitive, powerlaw plasticity. For the output of data, see \*DATABASE\_SUPERPLASTIC\_FORMING. Mass scaling is recommended in SPF applications.

New options to compute the target strain rate value with various averaging techniques and autojump options to control the simulation are implemented. Strain-rate speed up is also available. See Remarks 5-7 for details.

Card 1            1            2            3            4            5            6            7            8

Variable	LCP1	CSP1	NCP1	LCP2	CSP2	NCP2	PCTS1	PCTS2
Type	I	I	F	I	I	F	F	F
Default	none	none	none.	none	none	none	100.0	100.0
Remarks				1	1	1		

Card 2            1            2            3            4            5            6            7            8

Variable	ERATE	SCMIN	SCMAX	NCYL	(Not Used)	LEVEL	TSRCH	AT
Type	F	F	F	I		I	F	F
Default	none	none	none.	0		0	none	0.0
Remarks				2		5		

# \*LOAD

# \*LOAD\_SUPERPLASTIC\_FORMING

Card 3            1            2            3            4            5            6            7            8

Variable	TPEAK	TNEG	TOSC	POSC	PDROP	RILIM	RDLIM	STR
Type	F	F	F	F	F	F	F	F
Default	10.0	5.0	10.0	1.0	2.0	1.0	1.0	0.0
Remarks								6

Card 4            1            2            3            4            5            6            7            8

Variable	THRES	LOWER	UPPER	TFACT	NTFCT			
Type	F	F	F	F	I			
Default	5.0	90.0	99.0	1.0	10			
Remarks				7	7			

## VARIABLE

## DESCRIPTION

LCP1	Load curve number for Phase I pressure loading, (see *DEFINE_CURVE).
CSP1	Contact surface number to determine completion of Phase 1.
NCP1	Percent of nodes in contact to terminate Phase I, (see *CONTACT_OPTION).
LCP2	Load curve number for Phase II pressure loading (reverse), (see *DEFINE_CURVE).
CSP2	Contact surface to determine completion of Phase II, (see *CONTACT_OPTION).
NCP2	Percent of nodes in contact to terminate Phase II.

---

<b>VARIABLE</b>	<b>DESCRIPTION</b>
PCTS1	Percentage of nodes-in-contact to active autojump in Phase I forming.
PCTS2	Percentage of nodes-in-contact to active autojump in Phase II forming.
ERATE	Desired strain rate. This is the time derivative of the logarithmic strain.
SCMIN	Minimum allowable value for load curve scale factor. To maintain a constant strain rate the pressure curve is scaled. In the case of a snap through buckling the pressure may be removed completely. By putting a value here the pressure will continue to act but at a value given by this scale factor multiplying the pressure curve.
SCMAX	Maximum allowable value for load curve scale factor. Generally, it is a good idea to put a value here to keep the pressure from going to unreasonable values after full contact has been attained. When full contact is achieved the strain rates will approach zero and pressure will go to infinity unless it is limited or the calculation terminates.
NCYL	Number of cycles for monotonic pressure after reversal.
LEVEL	Criterion to compute averaged maximum of controlling variable: 0: no average used. >=1: averaging over neighbors of element with peak value of controlling variable. This parameter determines the level of neighbors search. -1: averaging over elements within selective range of peak controlling variable.
TSRCH	Time interval to conduct neighbors search.
AT	Time when SPF Phase I simulation starts.
TPEAK	Additional run time to terminate simulation when maximum pressure is reached.
TNEG	Additional run time to terminate simulation when percentage change of nodes-in-contact is zero or negative.
TOSC	Additional run time to terminate simulation when percentage change of nodes-in-contact oscillates within a specific value.
POSC	Percentage change to define the oscillation of percentage of nodes-in-contact.
PDROP	Drop in percentage of nodes-in-contact from the maximum to terminate simulation after the specified termination percentage has been reached.

---

<u>VARIABLE</u>	<u>DESCRIPTION</u>
STR	Autojump option or strike-through time (period of time without autojump check): 0: no autojump -1: autojump controlled by peak pressure -2: autojump controlled by percentage of nodes in contact -3: autojump controlled by both above >0: strike-through time, then same as STR=-3
THRES	Threshold percentage that gives the threshold value above which elements are considered for average.
LOWER	Lower percentile of elements above the threshold value to be included for average.
UPPER	Upper percentile of elements above the threshold value to be included for average.
RILIM	Maximum percentage change for pressure increment.
RDLIM	Maximum percentage change for pressure decrement.
TFACT	Strain rate peed up factor
NTFCT	Number of computing cycles to ramp up speedup

**Remarks:**

1. Optionally, a second phase can be defined. In this second phase a unique set of pressure segments must be defined whose pressure is controlled by load curve 2. During the first phase, the pressure segments of load curve 2 are inactive, and likewise, during the second phase the pressure segments of the first phase are inactive. When shell elements are used the complete set of pressure segments can be repeated in the input with a sign reversal used on the load curve. When solid elements are used the pressure segments for each phase will, in general, be unique.
2. This is an ad hoc parameter which should probably not be used.
3. Data in the output files "pressure", "curve1", and "curve2", may be plotted using ASCII > superpl in LS-PREPOST. The file "curve2" is created only if the second phase is active. See \*DATABASE\_SUPERPLASTIC\_FORMING.



4. The constraint method contact, `*CONTACT_CONSTRAINT_NODES_TO_SURFACE`, is recommended for superplastic forming simulations since the penalty methods are not as reliable when mass scaling is applied. Generally, in superplastic simulations mass scaling is used to enable the calculation to be carried out in real time.
5. In order to reduce the oscillation in pressure, the maximum strain rate used to adjust the pressure load is calculated by special averaging algorithm. There are two options available:

Averaging over neighbors of element with maximum strain rate: In this method, the element that has the maximum strain rate is stored in each cycle of the computation. The elements close to the element with the maximum strain rate are searched and stored in an array. The averaged maximum strain rate is computed over the neighboring elements. The user can input an integer number to control the level of neighbors search, which will affect the total number of elements for average. Because the neighbors search is time consuming, the user can input a time interval to limit the occurrence of searching. The neighbors search is conducted only when the simulation time reaches the specified time or the element with maximum strain rate falls out of the array of neighbors.

Averaging over elements within selective range of strain rate: In this method, all elements that have strain rate above a threshold value (a threshold percentage of maximum strain rate) are sorted according to their strain rate and the elements between the user specified lower percentile and upper percentile are selected to average the strain rate.
6. The SPF simulation can be controlled by various autojump options. When autojump conditions are met, the SPF simulation will be either terminated or continued from phase I to phase II simulation. The autojump check can be held inactive by setting a strikethrough time. In this case the SPF simulation will continue for that period of time and only be interrupted when the percentage of nodes-in-contact reaches 100% for a specified time. The available autojump conditions are:

Peak pressure is reached and stays for certain time: The peak pressure is determined by the maximum allowable scale factor and the load curve. The simulation will continue for a user specified time before termination.

User specified percentage of nodes-in-contact is reached: The simulation will be terminated or continued to Phase II automatically if one of the following conditions is met:

  - 1.) If the change of the percentage of nodes-in-contact is zero or negative for a specified time.
  - 2.) If the percentage of nodes-in-contact oscillates in a specified range for a specified time.
  - 3.) If the percentage of nodes-in-contact drops more than a specified value from the maximum value recorded.
  - 4.) If the percentage of nodes-in-contact reaches a user specified stop value.

7. In order to speed up the simulation of the superplastic forming process, we scale down the computation time. By doing this we increase the strain rate allowed in the SPF process, resulting in reduced simulation time. However, caution should be utilized with this speedup as it may affect the accuracy of the results. We recommend no or small strain rate speed up for simulations with complex geometry or tight angles.

**\*LOAD\_SURFACE\_STRESS\_{OPTION}**

Available options include:

**<BLANK>**

**SET**

Purpose: Store segment pressures from contact and applied pressure loads on the upper and lower surfaces of the shell surface. Applicable only when the THERMAL\_FRICTION option of \*CONTACT is invoked.

Card 1            1            2            3            4            5            6            7            8

Variable	PID/PSID							
Type	I							

Card 2            1            2            3            4            5            6            7            8

Variable	LSCID1	LSCID2	LSCID3	LSCID4	LSCID5	LSCID6	LSCID7	LSCID8
Type	I	I	I	I	I	I	I	I

Card 3            1            2            3            4            5            6            7            8

Variable	USCID1	USCID2	USCID3	USCID4	USCID5	USCID6	USCID7	USCID8
Type	I	I	I	I	I	I	I	I

**VARIABLE**

**DESCRIPTION**

PID/PSID

Part ID or if option set is active, part set ID.

<u>VARIABLE</u>	<u>DESCRIPTION</u>
LSCIDn	Lower surface contact ID's. Up to eight ID's can be defined. These contacts contribute to the pressure acting on the lower surface of the shell. If the pressure on the lower surface is due to applied pressure loads, specify a -1 instead of a contact ID. Only one, -1, may exist in the set of 8.
USCIDn	Upper surface contact ID's. Up to eight ID's can be defined. These contacts contribute to the pressure acting on the upper surface of the shell. . If the pressure on the upper surface is due to applied pressure loads, specify a -1 instead of a contact ID. Only one, -1, may exist in the set of 8.

**\*LOAD\_THERMAL\_OPTION**

Available options include:

**CONSTANT**

**CONSTANT\_ELEMENT\_OPTION**

**CONSTANT\_NODE**

**LOAD\_CURVE**

**TOPAZ**

**VARIABLE**

**VARIABLE\_ELEMENT\_OPTION**

**VARIABLE\_NODE**

**VARIABLE\_SHELL\_OPTION**

Purpose: To define nodal temperatures that thermally load the structure. Nodal temperatures defined by the \*LOAD\_THERMAL\_OPTION method are all applied in a structural only analysis. They are ignored in a thermal only or coupled thermal/structural analysis, see \*CONTROL\_THERMAL\_OPTION.

All the \*LOAD\_THERMAL options cannot be used in conjunction with each other. Only those of the same thermal load type, as defined below in column 2, may be used together.

*LOAD_THERMAL_CONSTANT	- Thermal load type 1
*LOAD_THERMAL_ELEMENT	- Thermal load type 1
*LOAD_THERMAL_CONSTANT_NODE	- Thermal load type 1
*LOAD_THERMAL_LOAD_CURVE	- Thermal load type 2
*LOAD_THERMAL_TOPAZ	- Thermal load type 3
*LOAD_THERMAL_VARIABLE	- Thermal load type 4
*LOAD_THERMAL_VARIABLE_ELEMENT	- Thermal load type 4
*LOAD_THERMAL_VARIABLE_NODE	- Thermal load type 4
*LOAD_THERMAL_VARIABLE_SHELL	- Thermal load type 4

# \*LOAD

## \*LOAD\_THERMAL\_CONSTANT

### \*LOAD\_THERMAL\_CONSTANT

Purpose: Define nodal sets giving the temperature that remains constant for the duration of the calculation. The reference temperature state is assumed to be a null state with this option. A nodal temperature state, read in above and held constant throughout the analysis, dynamically loads the structure. Thus, the temperature defined can also be seen as a relative temperature to a surrounding or initial temperature.

Card 1            1            2            3            4            5            6            7            8

Variable	NSID	NSIDEX	BOXID					
Type	I	I	I					
Default	none	0.	0.					

Card 2            1            2            3            4            5            6            7            8

Variable	T	TE						
Type	F	F						
Default	0.	0.						

<u>VARIABLE</u>	<u>DESCRIPTION</u>
NSID	Nodal set ID containing nodes for initial temperature EQ.0: all nodes are included:
NSIDEX	Nodal set ID containing nodes that are exempted from the imposed temperature (optional).
BOXID	All nodes in box which belong to NSID are initialized. Others are excluded (optional).
T	Temperature
TE	Temperature of exempted nodes (optional)

**\*LOAD\_THERMAL\_CONSTANT\_ELEMENT\_OPTION**

Available options include:

**BEAM**

**SHELL**

**SOLID**

**TSHELL**

Purpose: Define a uniform element temperature that remains constant for the duration of the calculation. The reference temperature state is assumed to be a null state. An element temperature, read in above and held constant throughout the analysis, dynamically loads the structure. The defined temperature can also be seen as a relative temperature to a surrounding or initial temperature.

Card            1            2            3            4            5            6            7            8

Variable	EID	T						
Type	I	F						
Default	none	0.						

<u>VARIABLE</u>	<u>DESCRIPTION</u>
EID	Element ID
T	Temperature, see remark below.

**Remarks:**

1. The temperature range for the constitutive constants in the thermal materials must include the reference temperature of zero. If not termination will occur with a temperature out-of-range error immediately after the execution phase is entered.

# \*LOAD

## \*LOAD\_THERMAL\_CONSTANT\_NODE

### \*LOAD\_THERMAL\_CONSTANT\_NODE

Purpose: Define nodal temperature that remains constant for the duration of the calculation. The reference temperature state is assumed to be a null state with this option. A nodal temperature state, read in above and held constant throughout the analysis, dynamically loads the structure. Thus, the temperature defined can also be seen as a relative temperature to a surrounding or initial temperature.

Card            1            2            3            4            5            6            7            8

Variable	NID	T						
Type	I	F						
Default	none	0.						

#### VARIABLE

#### DESCRIPTION

NID	Node ID
T	Temperature, see remark below.

#### Remarks:

1. The temperature range for the constitutive constants in the thermal materials must include the reference temperature of zero. If not termination will occur with a temperature out-of-range error immediately after the execution phase is entered.



**\*LOAD\_THERMAL\_LOAD\_CURVE**

Purpose: Nodal temperatures will be uniform throughout the model and will vary according to a load curve. The temperature at time=0 becomes the reference temperature for the thermal material. The reference temperature is obtained from the optional curve for dynamic relaxation if this curve is used. The load curve option for dynamic relaxation is useful for initializing preloads.

Card            1            2            3            4            5            6            7            8

Variable	LCID	LCIDDR						
Type	I	I						
Default	none	0						

<u>VARIABLE</u>	<u>DESCRIPTION</u>
LCID	Load curve ID, see *DEFINE_CURVE, to define temperature versus time.
LCIDDR	An optional load curve ID, see *DEFINE_CURVE, to define temperature versus time during the dynamic relaxation phase.

**\*LOAD\_THERMAL\_TOPAZ**

Purpose: Nodal temperatures will be read in from the TOPAZ3D database. This file is defined in the EXECUTION SYNTAX, see GETTING STARTED.

**\*LOAD\_THERMAL\_VARIABLE**

Purpose: Define nodal sets giving the temperature that is variable in the duration of the calculation. The reference temperature state is assumed to be a null state with this option. A nodal temperature state, read in above and varied according to the load curve, dynamically loads the structure. Thus, the defined temperatures are relative temperatures to an initial reference temperature.

Card 1            1            2            3            4            5            6            7            8

Variable	NSID	NSIDEX	BOXID					
Type	I	I	I					
Default	none	0.	0.					

Card 2            1            2            3            4            5            6            7            8

Variable	TS	TB	LCID	TSE	TBE	LCIDE		
Type	F	F	I	F	F	I		
Default	0.	0.	none	0.	0.	none		
Remark	1	1	1	1	1			

<u>VARIABLE</u>	<u>DESCRIPTION</u>
NSID	Nodal set ID containing nodes (see *SET_NODE_OPTION): EQ.0: all nodes are included.
NSIDEX	Nodal set ID containing nodes that are exempted (optional), (see *SET_NODE_OPTION).
BOXID	All nodes in box which belong to NSID are initialized. Others are excluded.
TS	Scaled temperature.

<u>VARIABLE</u>	<u>DESCRIPTION</u>
TB	Base temperature.
LCID	Load curve ID that multiplies the scaled temperature, (see *DEFINE_CURVE).
TSE	Scaled temperature of the exempted nodes (optional).
TBE	Base temperature of the exempted nodes (optional).
LCIDE	Load curve ID that multiplies the scaled temperature of the exempted nodes (optional), (see *DEFINE_CURVE).

**Remarks:**

1. The temperature is defined as

$$T = T_{\text{base}} + T_{\text{scale}} f(t)$$

where  $f(t)$  is the current value of the load curve,  $T_{\text{scale}}$  is the scaled temperature, and  $T_{\text{base}}$  is the base temperature.

**\*LOAD\_THERMAL\_VARIABLE\_BEAM\_{OPTION}**

Available options include:

**<BLANK>**

**SET**

Purpose: Define a known temperature time history as a function of the section coordinates for beam elements. To set the temperature for the whole element see \*LOAD\_THERMAL\_ELEMENT\_BEAM.

Card 1            1            2            3            4            5            6            7            8

Variable	ID	EID/SID						
Type	I	I						
Default	none	2						

**Card 2, 3, 4, etc. Input is terminated when a “\*” card is found.**

Card 2...        1            2            3            4            5            6            7            8

Variable	TBASE	TSCALE	TCURVE	TCURDR	SCOOR	TCOOR		
Type	F	F	I	I	F	F		
Default	0	1.0	constant	TCURVE	none	none		

<u>VARIABLE</u>	<u>DESCRIPTION</u>
ID	Load case ID
EID/SID	Shell/Shell set ID.
TBASE	Base temperature
TSCALE	Scale factor on temperature from load curve
TCURVE	Load curve ID for temperature vs time

<u>VARIABLE</u>	<u>DESCRIPTION</u>
TCURDR	Load curve ID used during dynamic relaxation
SCOOR	Relative coordinate in local S-direction (-1.0 to +1.0)
TCOOR	Relative coordinate in local T-direction (-1.0 to +1.0)

**Remarks:**

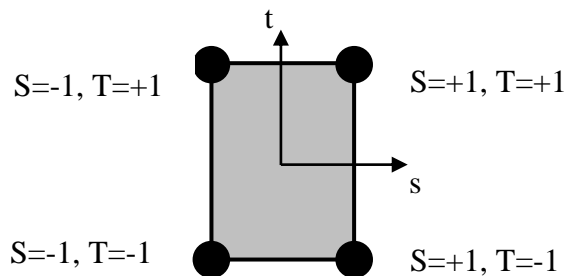
1. The temperature is defined as:

$$T = T_{\text{base}} + T_{\text{scale}} f(t)$$

where  $f(t)$  is the current value of the load curve,  $T_{\text{scale}}$  is the scaled temperature, and  $T_{\text{base}}$  is the base temperature.

2. If a load curve ID is undefined, unity is used instead of the value from the curve.
3. At least four points must be define in a rectangular grid.
4. At least two points must be defined.
5. Points must be defined in the following order, where S1, S2, S3 ... are in increasing order, as are T1, T2, T3 ...

The axis system is the beam local axis system, i.e. the s-axis is in the plane of the third node of the beam element.



**\*LOAD\_THERMAL\_VARIABLE\_ELEMENT\_OPTION**

Available options include:

**BEAM**

**SHELL**

**SOLID**

**TSHELL**

Purpose: Define element temperature that is variable during the calculation. The reference temperature state is assumed to be the temperature at time=0.0 with this option.

Card	1	2	3	4	5	6	7	8
------	---	---	---	---	---	---	---	---

Variable	EID	TS	TB	LCID				
Type	I	F	F	I				
Default	none	0.	0.	none				

<u>VARIABLE</u>	<u>DESCRIPTION</u>
NID	Element ID
TS	Scaled temperature
TB	Base temperature
LCID	Load curve ID defining a scale factor that multiplies the scaled temperature as a function of time, (see *DEFINE_CURVE).

**Remarks:**

- The temperature is defined as:

$$T = T_{base} + T_{scale} f(t)$$

where  $f(t)$  is the current value of the load curve,  $T_{scale}$  is the scaled temperature, and  $T_{base}$  is the base temperature

# \*LOAD

## \*LOAD\_THERMAL\_VARIABLE\_NODE

### \*LOAD\_THERMAL\_VARIABLE\_NODE

Purpose: Define nodal temperature that is variable during the calculation. The reference temperature state is assumed to be a null state with this option. A nodal temperature state read in and varied according to the load curve dynamically loads the structure. Thus, the defined temperatures are relative temperatures to an initial reference temperature.

Card            1            2            3            4            5            6            7            8

Variable	NID	TS	TB	LCID				
Type	I	F	F	I				
Default	none	0.	0.	none				

<u>VARIABLE</u>	<u>DESCRIPTION</u>
NID	Node ID
TS	Scaled temperature
TB	Base temperature
LCID	Load curve ID that multiplies the scaled temperature, (see *DEFINE_CURVE).

### Remarks:

1. The temperature is defined as:

$$T = T_{\text{base}} + T_{\text{scale}} f(t)$$

where  $f(t)$  is the current value of the load curve,  $T_{\text{scale}}$  is the scaled temperature, and  $T_{\text{base}}$  is the base temperature



**\*LOAD\_THERMAL\_VARIABLE\_SHELL\_{OPTION}**

Available options include:

**<BLANK>**

**SET**

Purpose: Define a known temperature time history as a function of the through-thickness coordinate for the shell elements.

Card 1            1            2            3            4            5            6            7            8

Variable	ID	EID/SID						
Type	I	I						
Default	none	2						

**Card 2, 3, 4, etc. Input is terminated when a “\*” card is found.**

Card 2...        1            2            3            4            5            6            7            8

Variable	TBASE	TSCALE	TCURVE	TCURDR	ZCO			
Type	F	F	I	I	F			
Default	0	1.0	constant	TCURVE	-1/+1			

<u>VARIABLE</u>	<u>DESCRIPTION</u>
ID	Load case ID
EID/SID	Shell/Shell set ID.
TBASE	Base temperature
TSCALE	Scale factor on temperature from load curve
TCURVE	Load curve ID for temperature vs time

<u>VARIABLE</u>	<u>DESCRIPTION</u>
TCURDR	Load curve ID used during dynamic relaxation
ZCO	Relative coordinate through-thickness (-1.0 to +1.0)

**Remarks:**

1. The temperature is defined as:

$$T = T_{\text{base}} + T_{\text{scale}} f(t)$$

where  $f(t)$  is the current value of the load curve,  $T_{\text{scale}}$  is the scaled temperature, and  $T_{\text{base}}$  is the base temperature.

2. If a load curve ID is undefined, unity is used instead of the value from the curve.
3. Through-thickness points must be defined in order of increasing ZCO (-1.0 to +1.0). CZO=+1.0 is the top surface of the element, i.e. the element surface in the positive outward normal vector direction from the mid-plane.
4. At least two points must be defined.
5. If the element has multiple in-plane integration points – the same temperature distribution is used at each in-plane integration point.
6. If a shell's temperature distribution is defined using this card any values defined by \*LOAD\_THERMAL\_NODE are ignored for that shell.

**\*LOAD\_VOLUME\_LOSS**

Purpose: To represent the effect of tunneling on surrounding structures, it is common to assume that a pre-defined fraction (e.g., 2%) of the volume occupied by the tunnel is lost during the construction process. Available for solid elements only. This feature is currently unavailable in MPP.

Note: This keyword card will be available starting in release 3 of version 971.

Card            1            2            3            4            5            6            7            8

Variable	PSID	COORD	LCUR	FX	FY	FZ	PMIN	FACTOR
Type	I	I	I	F	F	F	F	F
Default	none	0	0	1	1	1	-1.e20	.01

**VARIABLE****DESCRIPTION**

PSID	Part Set ID
COORD	Coordinate System ID (default - global coordinate system)
LCUR	Curve ID containing volume fraction lost vs. time
FX	Fraction of strain occurring in X-direction
FY	Fraction of strain occurring in Y-direction
FZ	Fraction of strain occurring in Z-direction
PMIN	(Leave blank)
FACTOR	Feedback factor

**Remarks:**

Volume loss is modeled by a process similar to thermal contraction: if the material is unrestrained it will shrink while remaining unstressed; if restrained, stresses will become more tensile. Typically the material surrounding the tunnel offers partial restraint; the volume loss algorithm adjusts the applied “thermal” strains to attempt to achieve the desired volume loss. Optionally, FX, FY and FZ may be defined: these will be treated as ratios for the X, Y and Z strains; this feature can be used to prevent contraction parallel to the tunnel axis.

The total volume of all the parts in the part set is monitored and output at the time-history interval (on \*DATABASE\_BINARY\_D3THDT) to a file named vloss\_output. This file contains lines of data (*time, volume1, volume2, volume3...*) where volume1 is the total volume of elements controlled by the first \*LOAD\_VOLUME\_LOSS card, volume2 is the total volume of elements controlled by the second \*LOAD\_VOLUME\_LOSS card, etc.

# **\*NODE**

The keywords defined in this section include:

**\*NODE\_{OPTION}**

**\*NODE\_MERGE\_SET**

**\*NODE\_MERGE\_TOLERANCE**

**\*NODE\_RIGID\_SURFACE**

**\*NODE\_SCALAR\_{OPTION}**

**\*NODE\_TRANSFORM**

**\*NODE\_{OPTION}**

Available options include:

**<BLANK>****MERGE**

Purpose: Define a node and its coordinates in the global coordinate system. Also, the boundary conditions in global directions can be specified. Generally, nodes are assigned to elements; however, exceptions are possible, see remark 2 below. The nodal point ID must be unique relative to other nodes defined in the \*NODE section. The MERGE option is usually applied to boundary nodes on disjoint parts and only applies to nodes defined when the merge option is invoked. With this option, nodes with identical coordinates are replaced during the input phase by the first node encountered that shares the coordinate. During the merging process a tolerance is used to determine whether a node should be merged. This tolerance can be defined using the keyword \*NODE\_MERGE\_TOLERANCE keyword, which is recommended over the default value. See the \*NODE\_MERGE\_TOLERANCE input description in the next section.

Card 1            1            2            3            4            5            6            7            8            9            10

Variable	NID	X	Y	Z	TC	RC	
Type	I	F	F	F	F	F	
Default	none	0.	0.	0.	0.	0.	
Remarks					1	1	

**VARIABLE****DESCRIPTION**

NID	Node number
X	x coordinate
Y	y coordinate
Z	z coordinate

---

<u>VARIABLE</u>	<u>DESCRIPTION</u>
TC	Translational Constraint: EQ.0: no constraints, EQ.1: constrained x displacement, EQ.2: constrained y displacement, EQ.3: constrained z displacement, EQ.4: constrained x and y displacements, EQ.5: constrained y and z displacements, EQ.6: constrained z and x displacements, EQ.7: constrained x, y, and z displacements.
RC	Rotational constraint: EQ.0: no constraints, EQ.1: constrained x rotation, EQ.2: constrained y rotation, EQ.3: constrained z rotation, EQ.4: constrained x and y rotations, EQ.5: constrained y and z rotations, EQ.6: constrained z and x rotations, EQ.7: constrained x, y, and z rotations.

**Remarks:**

1. Boundary conditions can also be defined on nodal points in a local (or global) system by using the keyword **\*BOUNDARY\_SPC**. For other possibilities also see the **\*CONSTRAINED** keyword section of the manual.
2. A node without an element or a mass attached to it will be assigned a very small amount of mass and rotary inertia. Generally, massless nodes should not cause any problems but in rare cases may create stability problems if these massless nodes interact with the structure. Warning messages are printed when massless nodes are found. Also, massless nodes are used with rigid bodies to place joints, see **\*CONSTRAINED\_EXTRA\_NODES\_OPTION** and **\*CONSTRAINED\_NODAL\_RIGID\_BODY**.

**\*NODE\_MERGE\_SET**

Purpose: The MERGE\_SET option is applied to a set of boundary nodes on disjoint part. With this option, nodes with identical coordinates that are members of any node set ID defined by this keyword are replaced during the input phase by one node within the set or sets. Of the nodes sharing the same coordinates, the node chosen is the one with the smallest ID. During the merging process a tolerance is used to determine whether a node should be merged. This tolerance can be defined using the keyword \*NODE\_MERGE\_TOLERANCE keyword, which is recommended over the default value. See the \*NODE\_MERGE\_TOLERANCE input description in the next section. Only nodes contained within the specified sets will be merged. Nodes contained within the set are defined by the \*NODE keyword. With this option, the keyword \*NODE\_MERGE is not needed.

Card 1            1            2            3            4            5            6            7            8

Variable	NSID								
Type	I								
Default	none								

**VARIABLE****DESCRIPTION**

NSID

Node set ID containing list of nodes to be considered for merging.



**\*NODE\_MERGE\_TOLERANCE**

Purpose: Define a tolerance is determine whether a node should be merged for the keyword, \*NODE\_MERGE.

Card 1            1            2            3            4            5            6            7            8

Variable	TOLR								
Type	F								
Default	yes								

**VARIABLE**

**DESCRIPTION**

TOLR	Physical distance used to determine whether to merge a nodal pair of nearby nodes. See remark below.
------	--

**Remarks:**

If the tolerance, TOLR, is undefined or if it is defaulted to zero, a value is computed as:

$$TOLR = 10^{-5} \cdot \frac{XMAX + YMAX + ZMAX - XMIN - YMIN - ZMIN}{3 \cdot \sqrt[3]{NUMNP}}$$

where XMIN, XMAX, YMIN, YMAX, ZMIN, and ZMAX represent the minimum and maximum values of the (x,y,z) nodal point coordinates in the global coordinate system, and NUMNP is the number of nodal points.

# \*NODE

# \*NODE\_RIGID\_SURFACE

## \*NODE\_RIGID\_SURFACE

Purpose: Define a rigid node and its coordinates in the global coordinate system. These nodes are used to define rigid road surfaces and they have no degrees of freedom. The nodal points are used in the definition of the segments that define the rigid surface. See \*CONTACT\_RIGID\_SURFACE. The nodal point ID must be unique relative to other nodes defined in the \*NODE section.

Card 1            1            2            3            4            5            6            7            8            9            10

Variable	NID	X	Y	Z						
Type	I	F	F	F						
Default	none	0.	0.	0.						
Remarks										

### VARIABLE

### DESCRIPTION

NID	Node number
X	x coordinate
Y	y coordinate
Z	z coordinate

**\*NODE\_SCALAR\_{OPTION}**

Available options include:

**<BLANK>**

**VALUE**

Purpose: Define a scalar nodal point which has one degree-of-freedom. The scalar point ID must be unique relative to other nodes defined in the \*NODE section.

**Define the following card if and if no option is picked**

Card 1            1            2            3            4            5            6            7            8            9            10

Variable	NID	NDOF									
Type	I	I									
Default	none	0									

**Define the following card for and only for option VALUE**

Card 1            1            2            3            4            5            6            7

Variable	NID	X1	X2	X3	NDOF		
Type	I	F	F	F	I		
Default	none	0	0	0	0		

<u>VARIABLE</u>	<u>DESCRIPTION</u>
NID	Scalar node ID.
NDOF	Number of degrees-of-freedom EQ.0: fully constrained EQ.1: one degree-of-freedom EQ.2: two degrees-of-freedom EQ.3: three degrees-of-freedom
XI	Initial value of Ith degree of freedom.

# \*NODE

# \*NODE\_TRANSFORM

## \*NODE\_TRANSFORM

Purpose: Perform a transformation on a node set based on a transformation defined by the keyword \*DEFINE\_TRANSFORMATION.

Card 1            1            2            3            4            5            6            7            8

Variable	TRSID	NSID							
Type	I	I							
Default	none	none							

### VARIABLE

### DESCRIPTION

TRSID	The ID of the transformation defined under *DEFINE_TRANSFORMATION.
NSID	Node set ID of the set of nodes to be subject to the transformation.

# **\*PARAMETER**

Two keywords are used in this section.

**\*PARAMETER**

**\*PARAMETER\_DUPLICATION**

**\*PARAMETER\_EXPRESSION**

# \*PARAMETER

# \*PARAMETER

## \*PARAMETER\_{OPTION}

The available options are

<BLANK>

**LOCAL**

Purpose: Define the numerical values of parameter names referenced throughout the input file. The parameter definitions, if used, should be placed at the beginning of the input file following \*KEYWORD or at the beginning of an include file if the LOCAL option is specified.

**Define as many cards as necessary.**

Card 1            1            2            3            4            5            6            7            8

Variable	PRMR1	VAL1	PRMR2	VAL2	PRMR3	VAL3	PRMR4	VAL4
Type	A	I or F or C	A	I or F or C	A	I or F or C	A	I or F
Default	none	none	none	none	none	none	none	none

Card 2...        1            2            3            4            5            6            7            8

Variable	PRMRn	VALn	PRMRn+1	VALn+1	...	...		
Type	A	I or F or C	A	I or F or C				
Default	none	none	none	none				

### VARIABLE

### DESCRIPTION

PRMRn

Define the nth parameter in a field of 10. Within this field the first character must be either an "R" for a real number, an "I" for an integer or a "C" for a character string. Lower or upper case for "I" or "R" or "C" is okay. Following the type designation, define the name of the parameter using up to, but not exceeding nine characters. For example, when defining a shell thickness named, "SHLTHK", both inputs "RSHLTHK" or "R SHLTHK" can be used and placed anywhere in the field of 10. When referencing SHLTHK in the input file see Remark 1 below.

<b>VARIABLE</b>	<b>DESCRIPTION</b>
VALn	Define the value of the n parameter as either a real or integer number, or a character string consistent with preceding definition for PRMRn.

**Remarks:**

- Parameters can be referenced anywhere in the input by placing an "&" at the first column of its field followed by the name of the parameter without blanks. If a minus sign "-" is placed directly before "&", i.e., "-&", with no space the sign of the numerical value will be switched.
- \*PARAMETER\_LOCAL behaves like the \*PARAMETER keyword with one difference. A parameter defined by \*PARAMETER without the LOCAL option is visible and available at any later point in the input processing. Parameters defined via the LOCAL versions disappear when the input parser finishes reading the file in which they appear. LOCAL variables can temporarily mask non-LOCAL variables.

For example, suppose you have the following input files:

**main.k:**

```
*PARAMETER
R VAL1 1.0
*PARAMETER
R VAL2 2.0
*PARAMETER
R VAL3 3.0
*INCLUDE
```

**file1****file1:**

```
*PARAMETER
R VAL1 10.0
*PARAMETER_LOCAL
R VAL2 20.0
*PARAMETER_LOCAL
R VAL4 40.0
*INCLUDE
```

**file2**

.....

Then, inside file2 we will see VAL1=10.0, VAL2=20.0, VAL3=3.0 and VAL4=40.0. In main.k, after returning from file1, we will see VAL1=10.0, VAL2=2.0, and VAL3=3.0. VAL4 will not exist. This allows for include files that can set all their own parameters without clobbering the parameters in the rest of the input.

# \*PARAMETER

## \*PARAMETER\_DUPLICATION

### \*PARAMETER\_DUPLICATION

Purpose: The purpose is to control how the code behaves if a duplicate parameter definition is found in the input.

Card 1            1            2            3            4            5            6            7            8

Variable	DFLAG								
Type	I								
Default	1								

#### VARIABLE

#### DESCRIPTION

DFLAG

Flag to control treatment of duplicate parameter definitions:  
EQ.1: issue a warning and ignore the new definition (default)  
EQ.2: issue a warning and accept the new definition  
EQ.3: issue an error and ignore (terminates at end of input)  
EQ.4: accept silently  
EQ.5: ignore silently

#### Remarks:

A `_LOCAL` variable appearing in a file, which masks a non-`_LOCAL` parameter, won't trigger these actions; however, a `_LOCAL` that masks another `_LOCAL` or a non-`_LOCAL` that masks a non-`_LOCAL` will.



**\*PARAMETER\_EXPRESSION\_{OPTION}**

The available options are

**<BLANK>**

**LOCAL**

Purpose: Define the numerical values of parameter names referenced throughout the input file. Like the \*PARAMETER keyword, but allows for general algebraic expressions, not simply fixed values. The LOCAL option allows for include files to contain their own unique expressions without clobbering the expressions in the rest of the input. See the \*PARAMETER keyword above.

**Define as many cards as necessary.**

Card 1            1            2            3            4            5            6            7            8

Variable	PRMR1	EXPRESSION1						
Type	A	A						
Default	none	none						

Card 2...        1            2            3            4            5            6            7            8

Variable	PRMRn	EXPRESSIONn						
Type	A	A						
Default	none	none						

---

<u>VARIABLE</u>	<u>DESCRIPTION</u>
PRMR <sub>n</sub>	Define the nth parameter in a field of 10. Within this field the first character must be either an "R" for a real number or an "I" for an integer. Lower or upper case for "I" or "R" is okay. Following the type designation, define the name of the parameter using up to, but not exceeding seven characters. For example, when defining a shell thickness named, "SHLTHK", both inputs "RSHLTHK" or "R SHLTHK" can be used and placed anywhere in the field of 10. When referencing SHLTHK in the input file see Remark 1 below.
EXPRESSION <sub>n</sub>	General expression which is evaluated, having the result stored in PRMR <sub>n</sub> . The following functions are available: sin, cos, tan, csc, sec, ctn, asin, acos, atan, atan2, sinh, cosh, tanh, asinh, acosh, atanh, min, max, sqrt, mod, abs, sign, int, aint, nint, anint, float, exp, log, log10, float, and general arithmetic expressions involving +, -, *, /, and **. The standard rules regarding operator precedence are obeyed, and nested parentheses are allowed. The expression can reference previously defined parameters (with or without the leading &). The expression can be continued on multiple lines simply by leaving the first 10 characters of the continuation line blank.

**Remarks:**

1. Parameters can be referenced anywhere in the input by placing an "&" at the first column of its field followed by the name of the parameter without blanks. Expressions can be included in the input when placed between brackets "<>" as long as the total line length does not exceed 80 columns.
2. The integer and real properties of constants and parameters are honored when evaluating expressions. So 2/5 becomes 0, but 2.0/5 becomes 0.4.
3. The sign, atan2, min, max, and mod functions all take two arguments. The others all take only 1.
4. Functions that use an angle as their argument, e.g., sin or cos, assume the angle is in radians.

# **\*PART**

The following keywords are used in this section:

**\*PART\_{OPTION1}\_{OPTION2}\_{OPTION3}\_{OPTION4}**

**\*PART\_ADAPTIVE\_FAILURE**

**\*PART\_ANNEAL**

**\*PART\_COMPOSITE\_{OPTION}**

**\*PART\_DUPLICATE**

**\*PART\_MODES**

**\*PART\_SENSOR**

**\*PART\_MOVE**

**\*PART\_{OPTION1}\_{OPTION2}\_{OPTION3}\_{OPTION4}\_{OPTION5}**

For OPTION1 the available options are

**<BLANK>**

**INERTIA**

**REPOSITION**

For OPTION2 the available options are

**<BLANK>**

**CONTACT**

For OPTION3 the available options are

**<BLANK>**

**PRINT**

For OPTION4 the available options are

**<BLANK>**

**ATTACHMENT\_NODES**

For OPTION5 the available options are

**<BLANK>**

**AVERAGED**

Options 1, 2, 3, 4, and 5 may be specified in any order on the \*PART card.

Purpose: Define parts, i.e., combine material information, section properties, hourglass type, thermal properties, and a flag for part adaptivity.

The INERTIA option allows the inertial properties and initial conditions to be defined rather than calculated from the finite element mesh. This applies to rigid bodies, see \*MAT\_RIGID, only. The REPOSITION option applies to deformable materials and is used to reposition deformable materials attached to rigid dummy components whose motion is controlled by either CAL3D or MADYMO. At the beginning of the calculation each component controlled by CAL3D/MADYMO is automatically repositioned to be consistent with the CAL3D/MADYMO input. However, deformable materials attached to these components will not be repositioned unless this option is used.

---

The CONTACT option allows part based contact parameters to be used with the automatic contact types a3, 4, a5, a10, 13, a13, 15 and 26, that is

\*CONTACT\_AUTOMATIC\_SURFACE\_TO\_SURFACE

\*CONTACT\_SINGLE\_SURFACE,

\*CONTACT\_AUTOMATIC\_NODES\_TO\_SURFACE,

\*CONTACT\_AUTOMATIC\_ONE\_WAY\_SURFACE\_TO\_SURFACE,

\*CONTACT\_AUTOMATIC\_SINGLE\_SURFACE,

\*CONTACT\_AIRBAG\_SINGLE\_SURFACE,

\*CONTACT\_ERODING\_SINGLE\_SURFACE,

\*CONTACT\_AUTOMATIC\_GENERAL.

The default values to use for these contact parameters can be specified on the \*CONTACT input section card.

The PRINT option allows user control over whether output data is written into the ASCII files MATSUM and RBDOUT. See \*DATABASE\_ASCII.

The AVERAGED option applies only to truss elements. The average strain and strain rate over the length of the \*PART truss elements is evaluated and used to evaluate the average axial force acting in all the elements, and this force is applied to all the elements. The system of elements should form one long continuous macro-element, and there should be no branching in the system. In effect, the truss elements behave as a string under uniform tension. This means that there are no forces acting to keep the nodes separated, and that other force contributions from the surrounding system will have to play that role. In other words the nodes connected to the truss elements should be attached to other structural members. An application where this option is appropriate are in modeling cables used in mechanical actuators. The AVERAGED option can be activated for all material types, which are available for truss elements.

Card 1            1            2            3            4            5            6            7            8

Variable	HEADING							
Type	C							
Default	none							
Remarks	1							

Card 2            1            2            3            4            5            6            7            8

Variable	PID	SECID	MID	EOSID	HGID	GRAV	ADPOPT	TMID
Type	I	A8	A8	A8	A8	I	I	A8
Default	none	none	none	0	0	0	0	0

**Additional Cards are required for the INERTIA option. See remarks 3 and 4.**

Card 3            1            2            3            4            5            6            7            8

Variable	XC	YC	ZC	TM	IRCS	NODEID		
Type	F	F	F	F	I	I		

Card 4            1            2            3            4            5            6            7            8

Variable	IXX	IXY	IXZ	IYY	IYZ	IZZ		
Type	F	F	F	F	F	F		

Card 5            1            2            3            4            5            6            7            8

Variable	VTX	VTY	VTZ	VRX	VRX	VRZ		
Type	F	F	F	F	F	F		

**Optional card required for IRCS=1. Define two local vectors or a local coordinate ID.**

Card 6            1            2            3            4            5            6            7            8

Variable	XL	YL	ZL	XLIP	YLIP	ZLIP	CID	
Type	F	F	F	F	F	F	I	
Remark	2	2	2	2	2	2	none	

**An additional Card is required for the REPOSITION option.**

Optional        1            2            3            4            5            6            7            8

Variable	CMSN	MDEP	MOVOPT					
Type	I	I	I					

**Additional Card is required for the CONTACT option.**

**WARNING:** If FS, FD, DC, and VC are specified they will not be used unless FS is set to a negative value (-1.0) in the \*CONTACT section. These frictional coefficients apply only to contact types: SINGLE\_SURFACE, AUTOMATIC\_GENERAL, AUTOMATIC\_SINGLE\_SURFACE, AUTOMATIC\_NODES\_TO\_..., AUTOMATIC\_SURFACE\_..., AUTOMATIC\_ONE\_WAY\_..., and ERODING\_SINGLE\_SURFACE. Default values are input via \*CONTROL\_CONTACT input.

Optional      1            2            3            4            5            6            7            8

Variable	FS	FD	DC	VC	OPTT	SFT	SSF	
Type	F	F	F	F	F	F	F	

**An additional Card is required for the PRINT option. This option applies to rigid bodies and provides a way to turn off ASCII output in files RBDOUT and MATSUM.**

Optional      1            2            3            4            5            6            7            8

Variable	PRBF							
Type	I							

**An additional Card is required for the ATTACHMENT\_NODES option. All nodes are treated as attachment nodes if this option is not used. Attachment nodes apply to rigid bodies only. The motion of these nodes, which must belong to the rigid body, are updated each cycle. Other nodes in the rigid body are updated only for output purposes. Include all nodes in the attachment node set which interact with the structure through joints, contact, merged nodes, applied nodal point loads, and applied pressure. Include all nodes in the attachment node set if their displacements, accelerations, and velocities are to be written into an ASCII output file. Body force loads are applied to the c.g. of the rigid body.**

Optional      1            2            3            4            5            6            7            8

Variable	ANSID							
Type	I							



<b>VARIABLE</b>	<b>DESCRIPTION</b>
HEADING	Heading for the part
PID	Part identification
SECID	Section identification defined in the *SECTION section
MID	Material identification defined in the *MAT section
EOSID	Equation of state identification defined in the *EOS section. Nonzero only for solid elements using an equation of state to compute pressure.
HGID	Hourglass/bulk viscosity identification defined in the *HOURLASS Section: EQ.0: default values are used.
GRAV	Part initialization for gravity loading. This option initializes hydrostatic pressure in the part due to gravity acting on an overburden material. This option applies to brick elements only and must be used with the *LOAD_DENSITY_DEPTH option: EQ.0: all parts initialized, EQ.1: only current material initialized.
ADPOPT	Indicate if this part is adapted or not. (See also *CONTROL_ ADAPTIVITY): LT.0: R-adaptive remeshing for 2-D solids,  ADOPT  gives the load curve ID that defines the element size as a function of time. EQ.0: adaptive remeshing is inactive for this part ID, EQ.1: H-adaptive for 3-D shells. EQ.2: R-adaptive remeshing for 2-D solids, 3-D tetrahedrons and 3-D EFG. EQ.9: Passive H-adptive for 3-D shells. The elements in this part will not be split unless their neighboring elements in other parts need to be split more than one level.
TMID	Thermal material property identification defined in the *MAT_THERMAL Section. Thermal properties must be specified for all solid, shell, and thick shell parts if a thermal or coupled thermal structural/analysis is being performed. Beams and discrete elements are not considered in thermal analyses. EQ.0: defaults to MID
XC	x-coordinate of center of mass. If nodal point, NODEID, is defined XC, YC, and ZC are ignored and the coordinates of the nodal point, NODEID, are taken as the center of mass.

---

<b>VARIABLE</b>	<b>DESCRIPTION</b>
YC	y-coordinate of center of mass
ZC	z-coordinate of center of mass
TM	Translational mass
IRCS	Flag for inertia tensor reference coordinate system: EQ.0: global inertia tensor, EQ.1: local inertia tensor is given in a system defined by the orientation vectors.
NODEID	Nodal point defining the CG of the rigid body. This node should be included as an extra node for the rigid body; however, this is not a requirement. If this node is free, its motion will not be updated to correspond with the rigid body after the calculation begins.
IXX	$I_{xx}$ , xx component of inertia tensor (see Remark 4)
IXY	$I_{xy}$ , xy component of inertia tensor (see Remark 4)
IXZ	$I_{xz}$ , xz component of inertia tensor (see Remark 4)
IYY	$I_{yy}$ , yy component of inertia tensor (see Remark 4)
IYZ	$I_{yz}$ , yz component of inertia tensor (see Remark 4)
IZZ	$I_{zz}$ , zz component of inertia tensor (see Remark 4)
VTX	initial translational velocity of rigid body in x direction
VTY	initial translational velocity of rigid body in y direction
VTZ	initial translational velocity of rigid body in z direction
VRX	initial rotational velocity of rigid body about x axis
VRX	initial rotational velocity of rigid body about y axis
VRZ	initial rotational velocity of rigid body about z axis
XL	x-coordinate of local x-axis. Origin lies at (0,0,0).
YL	y-coordinate of local x-axis
ZL	z-coordinate of local x-axis

<b>VARIABLE</b>	<b>DESCRIPTION</b>
XLIP	x-coordinate of vector in local x-y plane
YLIP	y-coordinate of vector in local x-y plane
ZLIP	z-coordinate of vector in local x-y plane
CID	Local coordinate system ID, see *DEFINE_COORDINATE_.... With this option leave fields 1-6 blank.
CMSN	CAL3D segment number/MADYMO system number. See the numbering in the corresponding program.
MDEP	MADYMO ellipse/plane number: GT.0: ellipse number, EQ.0: default, LT.0: absolute value is plane number.
MOVOPT	Flag to deactivate moving for merged rigid bodies, see *CONSTRAINED_RIGID_BODIES. This option allows a merged rigid body to be fixed in space while the nodes and elements of the generated CAL3D/MADYMO parts are repositioned: EQ.0: merged rigid body is repositioned, EQ.1: merged rigid body is not repositioned.
FS	Static coefficient of friction. The functional coefficient is assumed to be dependent on the relative velocity $v_{rel}$ of the surfaces in contact $\mu_c = FD + (FS - FD)e^{-DC \cdot  v_{rel} }$
FD	Dynamic coefficient of friction. The functional coefficient is assumed to be dependent on the relative velocity $v_{rel}$ of the surfaces in contact $\mu_c = FD + (FS - FD)e^{-DC \cdot  v_{rel} }$
DC	Exponential decay coefficient. The functional coefficient is assumed to be dependent on the relative velocity $v_{rel}$ of the surfaces in contact $\mu_c = FD + (FS - FD)e^{-DC \cdot  v_{rel} }$
VC	Coefficient for viscous friction. This is necessary to limit the friction force to a maximum. A limiting force is computed $F_{lim} = VC \cdot A_{cont}$ . $A_{cont}$ being the area of the segment contacted by the node in contact. The suggested value for VC is to use the yield stress in shear $VC = \frac{\sigma_o}{\sqrt{3}}$ where $\sigma_o$ is the yield stress of the contacted material.

---

<u>VARIABLE</u>	<u>DESCRIPTION</u>
OPPT	Optional contact thickness. This applies to shells and beams.
SFT	Optional thickness scale factor for PART ID in automatic contact (scales true thickness). This option applies only to contact with shell elements. True thickness is the element thickness of the shell elements.
SSF	Scale factor on default slave penalty stiffness for this PART ID whenever it appears in the contact definition. If zero, SSF is taken as unity.
PRBF	Print flag for RBDOUT and MATSUM files. EQ.0: default is taken from the keyword *CONTROL_OUTPUT, EQ.1: write data into RBDOUT file only EQ.2: write data into MATSUM file only EQ.3: do not write data into RBDOUT and MATSUM
ANSID	Attachment node set ID. This option should be used very cautiously and applies only to rigid bodies. The attachment point nodes are updated each cycle whereas other nodes in the rigid body are updated only in the output databases. All loads seen by the rigid body must be applied through this nodal subset or directly to the center of gravity of the rigid body. If the rigid body is in contact this set must include all interacting nodes. EQ.0: All nodal updates are skipped for this rigid body. The null option can be used if the rigid body is fixed in space or if the rigid body does not interact with other parts, e.g., the rigid body is only used for some visual purpose.

**Remarks:**

1. HEADING default is standard material description, e.g. Material Type 1.
2. The local cartesian coordinate system is defined as described in \*DEFINE\_COORDINATE\_VECTOR. The local z-axis vector is the vector cross product of the x-axis and the in plane vector. The local y-axis vector is finally computed as the vector cross product of the z-axis vector and the x-axis vector. The local coordinate system defined by CID has the advantage that the local system can be defined by nodes in the rigid body which makes repositioning of the rigid body in a preprocessor much easier since the local system moves with the nodal points.
3. When specifying mass properties for a rigid body using the inertia option, the mass contributions of deformable bodies to nodes which are shared by the rigid body should be considered as part of the rigid body.

4. If the inertia option is used, all mass and inertia properties of the body must be specified for there are no default values. The inertia terms are always with respect to the center of mass of the rigid body. The reference coordinate system defines the orientation of the axes, not the origin. Note that the off-diagonal terms of the inertia tensor are opposite in sign from the products of inertia.
5. The initial velocity of the rigid body may be overwritten by the \*INITIAL\_VELOCITY card.

See parameter IRIGID on this card.

# \*PART

# \*PART\_ADAPTIVE\_FAILURE

## \*PART\_ADAPTIVE\_FAILURE

Purpose: This is an option for two-dimensional adaptivity to allow a part that is singly connected to split into two parts. This option is under development and will be generalized in the future to allow the splitting of parts that are multiply connected.

Card 1            1            2            3            4            5            6            7            8

Variable	PID	T						
Type	I	F						

<u>VARIABLE</u>	<u>DESCRIPTION</u>
PID	Part ID
T	Thickness. When the thickness of the part reaches this minimum value the part is split into two parts. The value for T should be on the order of the element thickness of a typical element.

**\*PART\_ANNEAL**

Available options include:

**<BLANK>**

**SET**

Purpose: To initialize the stress states at integration points within a specified part to zero at a given time during the calculation. This option is valid for parts that use constitutive models where the stress is incrementally updated. This option applies to the Hughes-Liu beam elements, the integrated shell elements, thick shell elements, and solid elements.

Card 1            1            2            3            4            5            6            7            8

Variable	PID/PSID	TIME						
Type	I	F						
Default	none	none						

**VARIABLE**

**DESCRIPTION**

PID/PSID

Part ID or part set ID if the SET option is active.

TIME

Time when the stress states are reinitialized.

**\*PART\_COMPOSITE\_{OPTION}**

Available options include:

**<BLANK>**

**CONTACT**

**TSHELL**

Purpose: The following input provides a simplified method of defining a composite material model for shell elements and thick shell elements that eliminates the need for user defined integration rules and part ID's for each composite layer. The material ID, thickness, material angle and thermal material ID for each through-thickness integration point of a composite shell or thick shell are provided below. The total number of integration points is determined by the number of entries on these cards. For shells, the total thickness of the composite shell is the sum of the integration point thickness THICK<sub>i</sub>; consequently, the shell thickness is assumed to be uniform. For thick shells, the total thickness is defined by the location of nodes on the top and bottom surface, so the THICK<sub>i</sub> values are scaled to fit the element. When \*PART\_COMPOSITE is used, a section definition, \*SECTION\_SHELL or \*SECTION\_TSHELL, and integration rule definition, \*INTEGRATION\_SHELL, are unnecessary.

The CONTACT option allows part based contact parameters to be used with the automatic contact types a3, 4, a5, a10, 13, a13, 15 and 26, which are listed under the \*PART definition above.

Card 1            1            2            3            4            5            6            7            8

Variable	HEADING							
Type	C							
Default	none							



The following card is required for thin shell composites. Omit this card if the TSHELL option is used.

Card 2            1            2            3            4            5            6            7            8

Variable	PID	ELFORM	SHRF	NLOC	MAREA	HGID	ADPOPT	THSHEL
Type	I	I	F	F	F	I	I	I
Default	none	0	1.0	0.0	0.0	0	0	0

The following card is required for the TSHELL option.

Card 2            1            2            3            4            5            6            7            8

Variable	PID	ELFORM	SHRF			HGID		TSHEAR
Type	I	I	F			I		I
Default	none	0	1.0			0		0

One additional card is required for the CONTACT option.

**WARNING:** If FS, FD, DC, and VC are specified they will not be used unless FS is set to a negative value (-1.0) in the \*CONTACT section. These frictional coefficients apply only to contact types: SINGLE\_SURFACE, AUTOMATIC\_GENERAL, AUTOMATIC\_SINGLE\_SURFACE, AUTOMATIC\_NODES\_TO\_..., AUTOMATIC\_SURFACE\_..., AUTOMATIC\_ONE\_WAY\_..., and ERODING\_SINGLE\_SURFACE. Default values are input via \*CONTROL\_CONTACT input.

Optional        1            2            3            4            5            6            7            8

Variable	FS	FD	DC	VC	OPTT	SFT	SSF	
Type	F	F	F	F	F	F	F	

# \*PART

# \*PART\_COMPOSITE

The material ID, thickness, and material angle for each through-thickness integration point of a composite shell are provided below (up to two integration points per card). The integration point data should be given sequentially starting with the bottommost integration point. The total number of integration points is determined by the number of entries on these cards. The next "\*" card terminates this input.

Card 3            1            2            3            4            5            6            7            8

Variable	MID1	THICK1	B1	TMID1	MID2	THICK2	B2	TMID2
Type	I	F	F	I	I	F	F	I

Cards 4...        1            2            3            4            5            6            7            8

Variable	MID3	THICK3	B3	TMID3	Etc.			
Type	I	F	F	I	I	F	F	I

**VARIABLE**

**DESCRIPTION**

HEADING

Heading for the part

PID

Part ID

VARIABLE	DESCRIPTION
ELFORM	<p>Element formulation options for thin shells:</p> <ul style="list-style-type: none"><li>EQ.1: Hughes-Liu,</li><li>EQ.2: Belytschko-Tsay,</li><li>EQ.3: BCIZ triangular shell,</li><li>EQ.4: C<sup>0</sup> triangular shell,</li><li>EQ.6: S/R Hughes-Liu,</li><li>EQ.7: S/R co-rotational Hughes-Liu,</li><li>EQ.8: Belytschko-Leviathan shell,</li><li>EQ.9: Fully integrated Belytschko-Tsay membrane,</li><li>EQ.10: Belytschko-Wong-Chiang,</li><li>EQ.11: Fast (co-rotational) Hughes-Liu,</li><li>EQ.16: Fully integrated shell element (very fast),</li></ul> <p>Element formulation options for thick shells:</p> <ul style="list-style-type: none"><li>EQ.1: one point reduced integration,</li><li>EQ.2: selective reduced 2 x 2 in plane integration,</li><li>EQ.3: assumed strain 2 x 2 in plane integration,</li><li>EQ.5: assumed strain reduced integration.</li></ul>
SHRF	<p>Shear correction factor which scales the transverse shear stress.</p>
NLOC	<p>Location of reference surface. If nonzero, the offset distance from the plane of the nodal points to the reference surface of the shell in the direction of the shell normal vector is a value <math>offset = -0.50 \times NLOC \times (average\ shell\ thickness)</math>. This offset is not considered in the contact subroutines unless CNTCO is set to 1 in *CONTROL_SHELL. Alternatively, the offset can be specified by using the OFFSET option in the *ELEMENT_SHELL input section.</p> <ul style="list-style-type: none"><li>EQ. 1.0: top surface,</li><li>EQ. 0.0: mid-surface (default),</li><li>EQ.-1.0: bottom surface.</li></ul>
MAREA	<p>Non-structural mass per unit area. This is additional mass which comes from materials such as carpeting. This mass is not directly included in the time step calculation.</p>
HGID	<p>Hourglass/bulk viscosity identification defined in the *HOURLASS Section:</p> <ul style="list-style-type: none"><li>EQ.0: default values are used.</li></ul>
ADPOPT	<p>Indicate if this part is adapted or not. Also see, *CONTROL_ADAPTIVITY:</p> <ul style="list-style-type: none"><li>EQ.0: no adaptivity,</li><li>EQ.1: H-adaptive for 3-D shells.</li></ul>

<b>VARIABLE</b>	<b>DESCRIPTION</b>
THSHEL	Thermal shell formulation EQ.0: Default is governed by THSHEL on *CONTROL_SHELL EQ.1: Thick thermal shell EQ.2: Thin thermal shell
TSHEAR	Flag for transverse shear strain distribution (see remarks 3 and 4): EQ.0.0: Parabolic, EQ.1.0: Constant through thickness.
FS	Static coefficient of friction. The functional coefficient is assumed to be dependent on the relative velocity $v_{rel}$ of the surfaces in contact $\mu_c = FD + (FS - FD)e^{-DC \cdot  v_{rel} }$
FD	Dynamic coefficient of friction. The functional coefficient is assumed to be dependent on the relative velocity $v_{rel}$ of the surfaces in contact $\mu_c = FD + (FS - FD)e^{-DC \cdot  v_{rel} }$
DC	Exponential decay coefficient. The functional coefficient is assumed to be dependent on the relative velocity $v_{rel}$ of the surfaces in contact $\mu_c = FD + (FS - FD)e^{-DC \cdot  v_{rel} }$
VC	Coefficient for viscous friction. This is necessary to limit the friction force to a maximum. A limiting force is computed $F_{lim} = VC \cdot A_{cont}$ . $A_{cont}$ being the area of the segment contacted by the node in contact. The suggested value for VC is to use the yield stress in shear $VC = \frac{\sigma_o}{\sqrt{3}}$ where $\sigma_o$ is the yield stress of the contacted material.
OPTT	Optional contact thickness. This applies to shells only.
SFT	Optional thickness scale factor for PART ID in automatic contact (scales true thickness). This option applies only to contact with shell elements. True thickness is the element thickness of the shell elements.
SSF	Scale factor on default slave penalty stiffness for this PART ID whenever it appears in the contact definition. If zero, SSF is taken as unity.
MIDi	Material ID of integration point i, see *MAT_.... Section.
THICKi	Thickness of integration point i.

---

<u>VARIABLE</u>	<u>DESCRIPTION</u>
Bi	Material angle of integration point i.
TMDi	Thermal material ID of integration point i

**Remarks:**

1. In cases where there is more than one orthotropic material model referenced by \*PART\_COMPOSITE, the orthotropic material orientation parameters (AOPT, BETA, and associated vectors) from the material model of the first orthotropic integration point apply to all the orthotropic integration points. AOPT, BETA, etc. input for materials of subsequent integration points is ignored.
2. All thick shell formulations and all shell formulations with the exception of BCIZ and DK elements, are based on first order shear deformation theory that yields constant transverse shear strains which violates the condition of zero traction on the top and bottom surfaces of the shell. Setting SHRF=0.83333 will compensate for this error and result in correct transverse shear deformation, so long as all layers have the same transverse stiffness. However, for composites that have a transverse shear stiffness that varies by layer, laminated shell theory, activated by LAMSHT on \*CONTROL\_SHELL, is a better option. When laminated shell theory is active, SHRF should be set to the default value of 1.0.
3. If thick shell elements are stacked on top of each other, the transverse shear stress distribution imposed by laminated shell theory is a poor assumption.. For this case, setting TSHEAR=1 is recommended since this will modify laminated shell theory to minimize discontinuities in the out-of-plane shear stress and approximate a constant shear stress through the layers. If thick shells are used in a single layer, then TSHEAR=0 is recommended.

**\*PART\_DUPLICATE**

Purpose: To provide a method of duplicating parts or part sets without the need to use the \*INCLUDE\_TRANSFORM option.

Card 1            1            2            3            4            5            6            7            8

Variable	PTYPE	TYPEID	IDPOFF	IDEOFF	IDNOFF	TRANID		
Type	A	I	I	I	I	I		
Default	none	none	0	0	0	0		

**VARIABLE****DESCRIPTION**

PTYPE	Set to "PART" to duplicate a single part or "PSET" to duplicate a part set.
TYPEID	ID of part or part set to be duplicated.
IDPOFF	ID offset of newly created parts.
IDEOFF	ID offset of newly created elements.
IDNOFF	ID offset of newly created nodes.
TRANID	ID of *DEFINE_TRANSFORMATION to transform the existing nodes in a part or part set.

**Remarks:**

1. All parts sharing common nodes have to be grouped in a \*PART\_SET and duplicated in a single \*PART\_DUPLICATE command so that the newly duplicated parts still share common nodes
2. The following elements which need a PART to complete their definition can be duplicated by using this command: \*ELEMENT\_SOLID, \*ELEMENT\_DISCRETE, \*ELEMENT\_SHELL, \*ELEMENT\_TSHELL, \*ELEMENT\_BEAM and \*ELEMENT\_SEATBELT.
3. This command only duplicates definition of nodes, elements and parts, not the associated constraints. For example, TC and RC defined in \*NODE will not be passed to the newly created nodes.

4. When IDNOFF=IDPOFF=IDEOFF=0, the existing part, or part set, will be transformed as per TRANID, no new node or elements will be created.

**\*PART\_MODES**

Purpose: Define mode shapes for a flexible rigid body. Currently, flexible rigid bodies cannot share nodes with other flexible rigid bodies or rigid bodies; however, interconnections to other flexible rigid bodies or to rigid bodies can use the penalty joint option. The flexible rigid bodies are not implemented with the Lagrange multiplier joint option. The deformations are modeled using the modes shapes obtained experimentally or in a finite element analysis, e.g., NASTRAN.pch file or an LSTC eigout file. These modes should include both constraint and attachment modes. For stress recovery in flexible rigid bodies, use of linear element formulations is recommended. A lump mass matrix is assumed in the implementation. Also see the keyword control card: \*CONTROL\_RIGID.

Card 1            1            2            3            4            5            6            7            8

Variable	PID	NMFB	FORM	ANSID	FORMAT	KMFLAG	NUPDF	SIGREC
Type	I	I	I	I	I	I	I	

Card 2            1            2            3            4            5            6            7            8

Variable	FILENAME							
Type	C							
Default	none							

**Define the following cards if and only if KMFLAG=1. Use as many cards as necessary to identify the NMFB kept modes. After NMFB modes are defined no further input is expected.**

Cards 3...        1            2            3            4            5            6            7            8

Variable	MODE1	MODE2	MODE3	MODE4	MODE5	MODE6	MODE7	MODE8
Type	I	I	I	I	I	I	I	I
Default	none	nont	none	nont	none	nont	none	nont



**Read optional modal damping cards here. A keyword card (with a "\*" in column 1) terminates this input.**

Card            1            2            3            4            5            6            7            8

Variable	MSTART	MSTOP	DAMPF					
Type	I	I	F					
Default	none	none	none					

<u>VARIABLE</u>	<u>DESCRIPTION</u>
PID	Part identification. This part must be a rigid body.
NMFB	Number of kept modes in flexible body. The number of modes in the file, FILENAME, must equal or exceed NMFB. If KMFLAG=0 the first NMFB modes in the file are used.
FORM	Flexible body formulation. See remark 5 below. EQ.0: exact EQ.1: fast
ANSID	Attachment node set ID (optional).
FORMAT	Input format of modal information: EQ.0: NASTRAN.pch file. EQ.1: (not supported) EQ.2: NASTRAN.pch file (LS-DYNA binary version). The binary version of this file is automatically created if a NASTRAN.pch file is read. The name of the binary file is the name of the NASTRAN.pch file but with ".bin" appended. The binary file is smaller and can be read much faster. EQ.3: LS-DYNA d3eigv binary eigenvalue database (see *CONTROL_IMPLICIT_EIGENVALUE). EQ.4: LS-DYNA d3mode binary constraint/attachment mode database (see *CONTROL_IMPLICIT_MODE). EQ.5: Both d3eigv and d3mode databases are input. Database names must be "d3eigv" and "d3mode", and FILENAME below is ignored. NMFB above gives the total number of modes in both databases.
KMFLAG	Kept mode flag. Selects method for identifying modes to keep.

---

<u>VARIABLE</u>	<u>DESCRIPTION</u>
	EQ.0: the first NMFB modes in the file, FILENAME, are used. EQ.1: define NMFB kept modes with additional input.
NUPDF	Nodal update flag. If active, an attachment node set, ANSID, must be defined. EQ.0: all nodes of the rigid part are updated each cycle. EQ.1: only attachment nodes are fully updated. All nodes in the body are output based on the rigid body motion without the addition of the modal displacements. For maximum benefit an attachment node set can also be defined with the PART_ATTACHMENT_NODES option. The same attachment node set ID should be used here.
SIGREC	Stress recovery flag. EQ.0: no stress recovery EQ.1: stress recovery only EQ.2: stress recovery and then set the recovery stress as initial stress when switching to flexible body. (Shell formulations 16, 18, 20, 21 and Solid formulation 2) EQ.3: only for shell elform=16, the recovery stress is based on elform=21, and then set the recovery stress as initial stress for elform=16 when switching to flexible body.
FILENAME	The path and name of a file which contains the modes for this rigid body.
MODEn	Keep normal mode, MODEn.
MSTART	First mode for damping, $(1 \leq MSTART \leq NMFB)$ .
MSTOP	Last mode for damping, MSTOP, $(1 \leq MSTOP \leq NMFB)$ . All modes between MSTART and MSTOP inclusive are subject to the same modal damping coefficient, DAMPF.
DAMPF	Modal damping coefficient, $\zeta$ .

**Remarks:**

1. The format of the file which contains the normal modes follows the file formats of NASTRAN output for modal information.
2. The mode set typically combines both normal modes and attachment modes. The eigenvalues for the attachment modes are computed from the stiffness and mass matrices.

3. The part ID specified must be either a single rigid body or a master rigid body (see \*CONSTRAINED\_RIGID\_BODIES) which can be made up of many rigid parts.
4. The modal damping is defined by the modal damping coefficient  $\zeta$ , where a value of 1.0 equals critical damping. For a one degree of freedom model system, the relationship between the damping and the damping coefficient is  $c = 2\zeta\omega_n m$ , where  $c$  is the damping,  $m$  is the mass, and  $\omega_n$  is the natural frequency,  $\sqrt{k/m}$ .
5. There are two formulation options. The first is a formulation that contains all the terms of the flexible body equations, and its cost grows approximately as the square of the number of modes. The second formulation ignores most of the second order terms appearing in the exact equations and its cost grows linearly with the number of modes. Users are responsible for determining which formulation is appropriate for their problems. In general, if the angular velocities are small and if the deflections are small with respect to the geometry of the system it is safe to use the second (faster) formulation.

# \*PART

# \*PART\_SENSOR

## \*PART\_SENSOR

Purpose: Activate and deactivate parts, based on sensor defined in ELEMENT\_SEATBELT\_SENSOR. This option applies to discrete beam element only.

Card 1            1            2            3            4            5            6            7            8

Variable	PID	SIDA	ACTIVE					
Type	I	I	I					
Default	0	0	0					

### VARIABLE

### DESCRIPTION

PID	Part ID, which is controlled by sensor
SIDA	Sensor ID to activate or deactivate part.
ACTIVE	Flag. If zero, the part is active from time zero until a signal is received by the part to deactivate. If one, the part is inactive from time zero and becomes active when a signal is received by the part to activate. The history variables for inactive parts are initialized at time zero.

**\*PART\_MOVE**

Purpose: Translate a part by an incremental displacement in either a local or a global coordinate system. This option currently applies to parts defined either by shell and solid elements. All nodal points of the given part ID are moved. Care must be observed since parts that share boundary nodes with the part being moved must also be moved to avoid severe mesh distortions.

**Cards 1,2,3,4, ... (the next "\*" card terminates the input)**

Card 1            1            2            3            4            5            6            7            8            9            10

Variable	PID/SID	XMOV	YMOV	ZMOV	CID	IFSET	
Type	I	F	F	F	I	I	
Default	none	0.0	0.0	0.0	0	0	

<u>VARIABLE</u>	<u>DESCRIPTION</u>
PID	Part identification.
XMOV	Move shell/solid part ID, PID, in the x-direction by the incremental distance, XMOV.
YMOV	Move shell/solid part ID, PID, in the y-direction by the incremental distance, YMOV.
ZMOV	Move shell/solid part ID, PID, in the z-direction by the incremental distance, ZMOV.
CID	Coordinate system ID to define incremental displacement in local coordinate system. All displacements, XMOV, YMOV, and ZMOV, are with respect to CID. EQ.0: global
IFSET	Indicate if part set ID (SID), is used in PID/SID definition. EQ.1: part set ID (SID) is used

**Remarks:**

1. A new variable IFSET is added to address the move of multiple parts that share common boundary nodes, e.g., in case of tailor-welded blank. The new variable allows for a part set to be move simultaneously. For example, keyword \*SET\_PART\_LIST can be used to

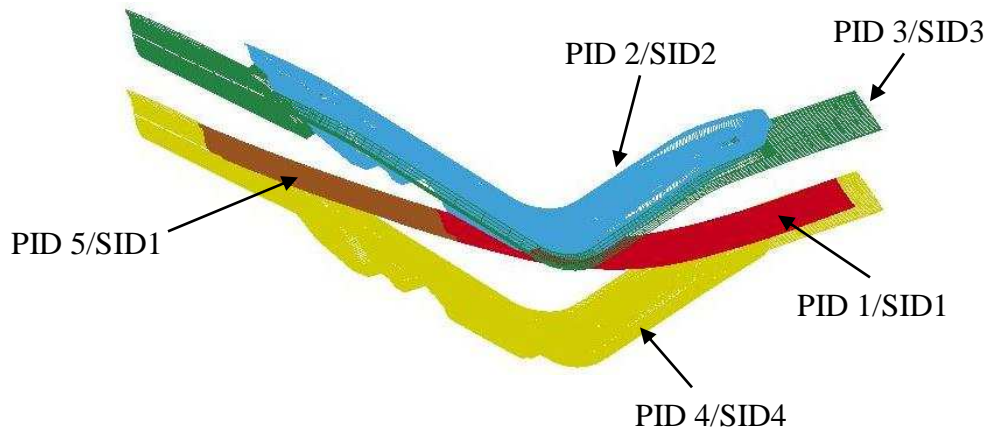
include all tailor welded blank parts and the resulting Part Set ID can be used in this keyword.

2. Draw beads can be modeled as beam elements and moved in the same distance in the same direction as either the die or punch, depending on the draw types.
3. A partial keyword input is provided to automatically position all tools in a toggle draw of a decklid inner, with tailor welded blanks PID 1 and PID5, as shown below:

```

*PARAMETER
R  blnkmv      0.0
R  upbinmv     0.0
R  uppunmv     0.0
*SET_PART_LIST
1
1,5
*SET_PART_LIST
2
2
*SET_PART_LIST
3
3
*SET_PART_LIST
4
4
*CONTROL_FORMING_AUTOPOSITION_PARAMETER_SET
$  PID/SID      CID      DIR  MPID/MSID  Position  PREMOVE  THICK  PARORDER
      1          3        3      4          1          1        1.5    blnkmv
      3          3        3      1          1          1        1.5    upbinmv
      2          3        3      1          1          1        1.5    uppunmv
$-----1-----2-----3-----4-----5-----6-----7-----8
*PART_MOVE
$  PID      XMOV      YMOV      ZMOV      CID  IFSET
      1      0.0      0.0      &blnkmv  CID  1
      3      0.0      0.0      &upbinmv  1
      2      0.0      0.0      &uppunmv  1

```



A tailor welded blank is positioned in a decklid toggle draw.

# **\*PERTURBATION**

The keyword **\*PERTURBATION** provides a means of defining deviations from the designed structure such as buckling imperfections. These perturbations can be viewed in LS-PREPOST as user-defined fringe plots. Available options are:

**\*PERTURBATION\_MATERIAL**

**\*PERTURBATION\_NODE**

**\*PERTURBATION\_SHELL\_THICKNESS**

**\*PERTURBATION\_OPTION**

Available options are:

**MATERIAL**

**NODE**

**SHELL\_THICKNESS**

Purpose: Define a perturbation (stochastic field) over the whole model or a portion of the model, typically to trigger an instability. The NODE option modifies the three dimensional coordinates for the whole model or a node set. For the SHELL\_THICKNESS option the shell thicknesses are perturbed for the whole model or a shell set. The MATERIAL option perturbs a material parameter value for all the elements associated with that material.

**Define for the MATERIAL option. Required**

Card 1            1            2            3            4            5            6            7            8

Variable	TYPE	PID	SCL	CMP	ICOORD	CID		
Type	I	I	F	I	I	I		
Default	1	0	1.0	7	0	0		

**Define for the NODE option. Required**

Card 1            1            2            3            4            5            6            7            8

Variable	TYPE	NID	SCL	CMP	ICOORD	CID		
Type	I	I	F	I	I	I		
Default	1	0	1.0	7	0	0		



**Define for the SHELL\_THICKNESS option. Required**

Card 1            1            2            3            4            5            6            7            8

Variable	TYPE	EID	SCL	ICOORD	CID			
Type	I	I	F	I	I			
Default	1	0	1.0	0	0			

**Define if TYPE is 1 (harmonic field). One or many definitions.**

Card 2            1            2            3            4            5            6            7            8

Variable	AMPL	XWL	XOFF	YWL	YOFF	ZWL	ZOFF	
Type	F	F	F	F	F	F	F	
Default	1.0	0.0	0.0	0.0	0.0	0.0	0.0	

**Define if TYPE is 2 (fade field). One definition only.**

Card 2            1            2            3            4            5            6            7            8

Variable	FADE							
Type	F							
Default	1.0							

# \*PERTURBATION

# \*PERTURBATION

Define if TYPE is 3 (file field). One definition only.

Card 2            1            2            3            4            5            6            7            8

Variable	FNAME							
Type	A							
Default	None							

Define if TYPE is 4 (spectral field). One definition only.

Card 2            1            2            3            4            5            6            7            8

Variable	CSTYPE	ELLIP1	ELLIP2	RND				
Type	I	F	F	I				
Default	None	1.0	1.0	0				

Define if TYPE is 4 (spectral field). One, two, or three definitions, depending on CSTYPE.

Card 3            1            2            3            4            5            6            7            8

Variable	CFTYPE	CFC1	CFC2	CFC3				
Type	I	F	F	F				
Default	None	1.0	1.0	1.0				

## VARIABLE

## DESCRIPTION

TYPE

Type of perturbation

EQ.1: Harmonic Field

EQ.2: Fade out all perturbations at this node set

EQ.3: Read perturbations from a file

EQ.4: Spectral field

---

<b>VARIABLE</b>	<b>DESCRIPTION</b>
PID	Part ID.
NID	Node set ID. Specify 0 to perturb all the nodes in the model.
EID	Element set ID. Specify 0 to perturb all the elements in the model.
SCL	Scale factor
CMP	Component. For the NODE option, these are given below. For the MATERIAL option, see the description of the material. EQ.1: x coordinate EQ.2: y coordinate EQ.3: z coordinate EQ.4: x and y coordinate EQ.5: y and z coordinate EQ.6: z and x coordinate EQ.7: x, y, and z coordinate
ICoord	Coordinate system to use; see remarks 7, 8 and 9 EQ.0: Global Cartesian EQ.1: Cartesian EQ.2: Cylindrical (computed and applied) EQ.3: Spherical (computed and applied) EQ.-2: Computed in cartesian but applied in cylindrical EQ.-3 Computed in cartesian but applied in spherical
CID	Coordinate system ID, see *DEFINE_COORDINATE_NODES
AMPL	Amplitude of the harmonic perturbation
XWL	x wavelength of the harmonic field
XOFF	x offset of harmonic field
YWL	y wavelength of the harmonic field
YOFF	y offset of harmonic field
ZWL	z wavelength of the harmonic field
ZOFF	z offset of harmonic field
FADE	Parameter controlling the distance over which all *PERTURBATION_NODE are faded to zero
FNAME	Name of file containing the perturbation definitions

<b>VARIABLE</b>	<b>DESCRIPTION</b>
CSTYPE	Correlation structure EQ.1: 3D isotropic. The X, Y and Z correlations are described using one correlation function. Define CFC1. EQ.2: 3D product. The X, Y and Z correlations are described using a correlation function each. Define CFC1, CFC2 and CFC3. EQ.3: 2D isotropic. A correlation function describes the X correlation while the YZ isotropic relationship is described using another correlation function. Define CFC1 and CFC2. EQ.4: 2D isotropic. The XZ isotropic relationship is described using a correlation function, while another correlation function describes the Y correlation while. Define CFC1 and CFC2. EQ.5: 2D isotropic. The XY isotropic relationship is described using a correlation function, while another correlation function describes the Z correlation while. Define CFC1 and CFC2. EQ.6: 3D elliptic. Define CSE1, CSE2 and CFC1. EQ.7: 2D elliptic. A correlation function describes the X correlation while the YZ elliptic relationship is described using another correlation function. Define CSE1 and CFC1. EQ.8: 2D elliptic. A correlation function describes the Y correlation while the ZX elliptic relationship is described using another correlation function. Define CSE1 and CFC1. EQ.9: 2D elliptic. The XY elliptic relationship is described using a correlation function, while another correlation function describes the Z correlation while. Define CSE1 and CFC1.
ELLIP1	Elliptic constant for 2D and 3D elliptic fields
ELLIP2	Elliptic constant for 3D elliptic field
RND	Seed for random number generator. EQ.0: LS-DYNA will generate a random seed GT.0: Value to be used as seed
CFTYPE	Correlation function EQ.1: Gaussian EQ.2: Exponential EQ.3: Exponential Cosine EQ.4: Rational EQ.5: Linear
CFCi	Correlation function constant i

**Remarks:**

1. The perturbation can be viewed in LS-PREPOST. For the NODE option, LS-DYNA creates files named pert\_node\_x/y/z/res, which can be viewed as user-defined fringe plots. For the SHELL\_THICKNESS and MATERIAL options, the files are named pert\_shell\_thickness and pert\_mat respectively. If a coordinate system with a radial component is used, then the file pert\_node\_radial is also written.
2. Perturbations specified using separate \*PERTURBATION cards are created separately and then added together. This is true as well for special cases such as CMP=7 in which case the x, y and z fields are created separately and added together afterwards, which can result in an absolute amplitude greater than specified using AMPL or SCL.

3. The harmonic perturbation is

$$P_{CMP}(x, y, z) = SCL * AMPL \left[ \sin \left( 2\pi \frac{x + XOFF}{XWL} \right) + \sin \left( 2\pi \frac{y + YOFF}{YWL} \right) + \sin \left( 2\pi \frac{z + ZOFF}{ZWL} \right) \right]$$

Note that the harmonic perturbations can sum to values greater than SCL\*AMPL.

4. The fade perturbation is  $p'(x, y, z) = SCL \left( 1 - \frac{1}{e^{\frac{FADE}{x'}}} \right) p(x, y, z)$  with  $x'$  the shortest distance to a node in the node set specified and FADE the parameter controlling the sharpness of the fade perturbation.
5. The file FNAME must contain the perturbation in the LS-DYNA keyword format. This file can be created from the d3plot results using the LS-PREPOST Output capability. The data must be arranged into two columns with the first column being the node ids. Lines starting with the character \$ will be ignored.

6. The correlation functions are defined as follows:

Gaussian:  $B(t) = e^{-(at)^2}$

Exponential:  $B(t) = e^{-|at|^b}$

Exponent and Cosine:  $B(t) = e^{-|at|} \cos(bt)$

Rational:  $B(t) = (1 + |at|^b)^{-c}$

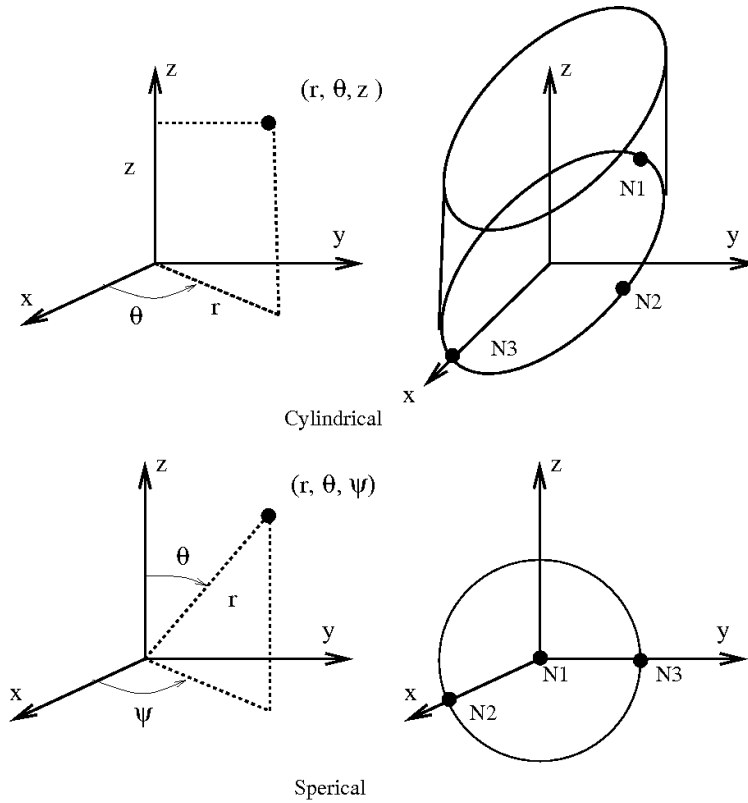
Piecewise Linear:  $B(t) = (1 - |at|) \chi(1 - |at|)$

With  $\chi$  the Heaviside step function and a, b and c corresponding to CFC1, CFC2 and CFC3.

7. For the cylindrical coordinate system option (ICOORD=2), the default is to use the global coordinate system for the location of the cylindrical part, with the base of the cylinder located

at the origin, and the global z-axis aligned with the cylinder axis. For cylindrical parts not located at the global origin, define a coordinate system (numbered CID) using \*DEFINE\_COORDINATE\_NODES by selecting any three nodes on the base of the cylinder in a clockwise direction (resulting in the local z-axis to be aligned with the cylinder).

8. For the spherical coordinate system (ICOORD=3), the coordinates are the radius, zenith angle ( $0 - \pi$ ), and the azimuth angle ( $0 - 2\pi$ ). The default is to use the global coordinate system with the zenith measured from the z-axis and the azimuth measured from the x-axis in the xy-plane. For spherical parts not located at the global origin, define a coordinate system using \*DEFINE\_COORDINATE\_NODES by selecting any three nodes as follows: the first node is the center of the sphere, the second specifies the x-axis of the coordinate system, while the third point specifies the plane containing the new y-axis. The z-axis will be normal to this plane.
9. It is possible to compute the perturbations in a Cartesian coordinate system, but to apply them in a cylindrical or spherical coordinate system (ICOORD=-2,-3). This is the natural method of doing say a radial perturbation of a sphere using a spectral perturbation field. We expect that computing the perturbation in the spherical coordinate system should be rare (ICOORD=3). Computing a perturbation in a cylindrical coordinate system should be common though; for example, a circumferential harmonic perturbation.
10. Only \*MAT238 (\*MAT\_PERT\_PIECEWISE\_LINEAR\_PLASTICITY) and solid elements in an explicit analysis can be perturbed using \*PERTURBATION\_MATERIAL. See the documentation of this material for allowable components. Only one part per model can be perturbed. The material perturbation is applied on an element-wise basis as  $value_{new} = (1 + p)value_{base}$  with p the perturbation value for the element as given in the file pert\_mat. Values of p less than -1 are accordingly illegal, because the material behavior is not defined.



**Figure 29.1** Creating coordinate systems for \*PERTURBATION. N1, N2 and N3 are the nodes that must be specified using \*DEFINE\_COORDINATE\_NODES to obtain the coordinate system shown.





# **\*RAIL**

Two keywords are defined in this section.

**\*RAIL\_TRACK**

**\*RAIL\_TRAIN**

**\*RAIL\_TRACK**

Purpose: Wheel-rail contact algorithm intended for railway applications but can also be used for other purposes. The wheel nodes (defined on \*RAIL\_TRAIN) represent the contact patch between wheel and rail. A penalty method is used to constrain the wheel nodes to slide along the track. A track consists of two rails, each of which is defined by a set of beam elements.

Card 1            1            2            3            4            5            6            7            8

Variable	ID	BSETID1	NORGN1	LCUR1	OSET1	SF1	GA1	
Type	I	I	I	I	F	F	F	
Default	none	None	None	None	0.0	1.0	0.0	

Card 2            1            2            3            4            5            6            7            8

Variable	BLANK	BSETID2	NORGN2	LCUR2	OSET2	SF2	GA2	
Type	-	I	I	I	F	F	F	
Default	-	None	None	None	0.0	1.0	0.0	

**VARIABLE****DESCRIPTION**

ID	Track ID
BSETID1,2	Beam set ID for rails 1 and 2 containing all beam elements that make up the rail, see *SET_BEAM.
NORGN1,2	Reference node at one end of each rail, used as the origin for the roughness curve. The train will move in a direction away from this node.
LCUR1,2	Load curve ID (see *DEFINE_CURVE) defining track roughness (vertical displacement from line of beam elements) of the rail as a function of distance from the reference node NORIGIN. Distance from reference node on x-axis of curve, roughness on y-axis. Default: no roughness.

---

<u>VARIABLE</u>	<u>DESCRIPTION</u>
OSET1,2	Origin of curve LCUR is shifted by distance OSET from the reference node.
SF1,2	Roughness values are scaled by SF. Default: 1.0.
GA1,2	Shear stiffness of rail per unit length (used to calculate local rail shear deformation within each beam element). GA = shear modulus x cross-sectional area. Default: local shear deformation is ignored.

**Remarks:**

\*RAIL\_TRACK and \*RAIL\_TRAIN were written by Arup to represent wheel-rail contact. They have been used to generate loading on models of bridges for vibration predictions, stress calculations and for estimating accelerations experienced by passengers. Other non-railway uses are possible: the algorithm causes the “train” nodes to follow the line defined by the “rail” beam elements and transfers forces between them. In some cases (especially vibration modeling), double precision versions of LS-DYNA may give superior results because of the small relative deflections between wheel and rail.

**Track modeling**

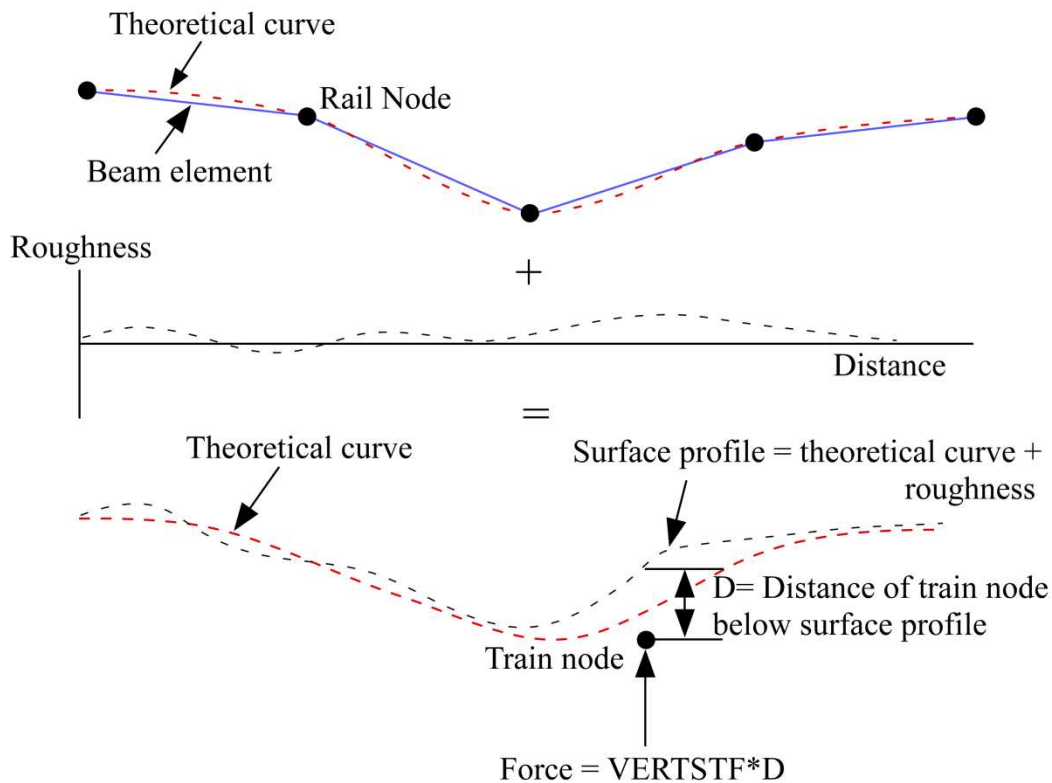
The rails of the track should be modeled by two parallel lines of beam elements. The track can be curved or straight and the rails can be modeled as deformable or rigid. If required, rail pads, sleepers and ballast may also be modeled – typically with spring, damper and beam elements. It is also possible to use this algorithm to control the motion of simple road vehicle models: beam element “rails” made of null material can be embedded in the road surface. It is recommended that the mesh size of the two rails should be similar: LS-DYNA calculates a local coordinate system for each train node based on the alignment of the currently contacted beam element and the nearest node on the other rail.

Because wheel-rail contact stiffness is generally very high, and wheel masses are large, small deviations from a straight line or smooth curve can lead to large transient forces. It is recommended that great care be taken in generating and checking the geometry for the track, especially where the track is curved. Some pre-processors write the coordinates with insufficient precision to the LS-DYNA input file, and this can cause unintended roughness in the geometry. For the same reason, if the line of the track were taken as straight between nodes, spurious forces would be generated when the wheel passes from one rail element to the next. This is avoided because the \*RAIL algorithm calculates a theoretical curved centerline for the rail element to achieve continuity of slope from one element to the next. Where the length of the rail elements is similar to or shorter than the maximum section dimension, shear deformation may be significant and it is possible to include this in the theoretical centerline calculation to further reduce spurious forces at the element boundaries (inputs GA1, GA2).

Roughness (small deviations in the vertical profile from a perfect straight line) does exist in real life and is a principal source of vibration. \*RAIL allows the roughness to be modeled by a load curve giving the vertical deviation (in length units) of the rail surface from the theoretical centerline of the beam elements as a function of distance along the track from the origin node of

the rail. The roughness curve is optional. Ideally, roughness profiles measured from both rails of the same piece of track should be used so that the relationship between bump and roll modes is correctly captured.

Whether roughness is included or not, it is important to select as the origin nodes (NORIGIN1 and NORIGIN2) the nodes at the end of the rails away from which the train will be traveling. The train can start at any point along the rails but must travel away from the origin nodes.



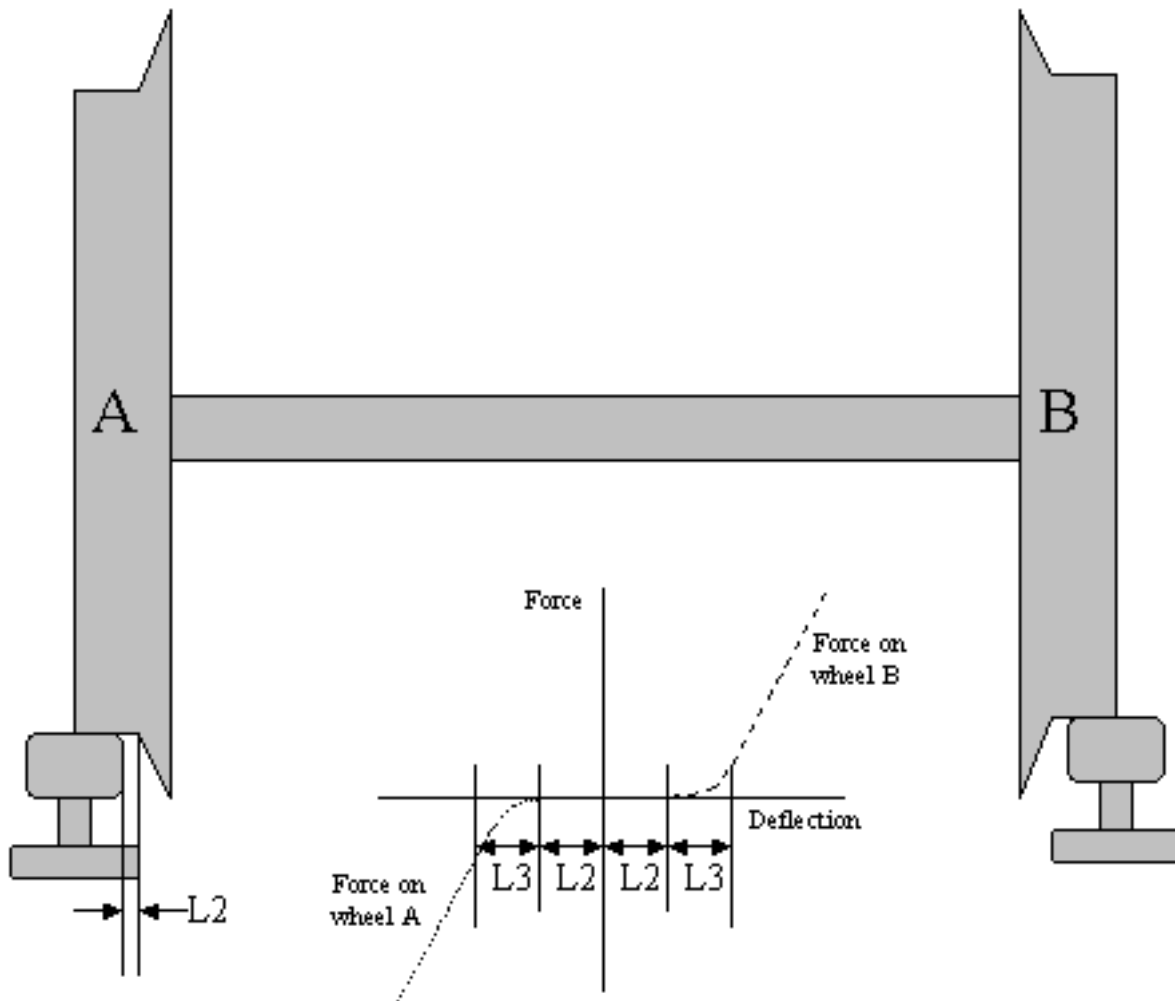
### Train modeling

The vehicle models are typically modeled using spring, damper and rigid elements, or simply a point mass at each wheel position. Each node in the set referred to on \*RAIL\_TRAIN represents the contact patch of one wheel (note: not the center of the wheel). These nodes should be initially on or near the line defined by either of the two rails. LS-DYNA will move the train nodes initially onto the rails to achieve the correct initial wheel-rail forces. If the results are viewed with magnified displacements, the initial movements can appear surprising.

Wheel roughness input is available. This will be applied in addition to track roughness. The input curve must continue for the total rolled distance – it is not assumed to repeat with each wheel rotation. This is to avoid problems associated with ensuring continuity between the start and end of the profile around the wheel circumference, especially since the profiles might be generated from roughness spectra rather than taken directly from measured data.

### Wheel-rail interface

The wheel-rail interface model is a simple penalty function designed to ensure that the train nodes follow the line of the track. It does not attempt to account for the shape of the rail profile. Vertical and lateral loads are treated independently. For this reason, the algorithm is not suitable for rail vehicle dynamics calculations.



Wheel-rail contact stiffness is input on \*RAIL\_TRAIN. For vertical loads, a linear force-deflection relationship is assumed in compression; no tensile force is generated (this corresponds to the train losing contact with the rail). Typical contact stiffness is 2MN/mm. Lateral deflections away from the theoretical centerline of the rail beams are also penalized by a linear force-deflection relationship. The lateral force is applied only to wheels on the side towards which the train has displaced (corresponding to wheel flanges that run inside the rails). Optionally, a “gap” can be defined (input parameter L2) such that the wheel set can drift laterally by L2 length units before any lateral force is generated. A further option is to allow smooth transition between “gap” and “contact” by means of a transition distance (input parameter L3). Generally, with straight tracks a simple linear stiffness is sufficient. With curved tracks, a

reasonable gap and transition distance should be defined to avoid unrealistic forces being generated in response to small inaccuracies in the distance between the rails. Gravity loading is expected, in order to maintain contact between rail and wheel. This is normally applied by an initial phase of dynamic relaxation. To help achieve convergence quickly, or in some cases avoid the need for dynamic relaxation altogether, the initial force expected on each train node can be input (parameter FINIT on \*RAIL\_TRAIN). LS-DYNA positions the nodes initially such that the vertical contact force will be FINIT at each node. If the suspension of the rail vehicles is modeled, it is recommended that the input includes carefully calculated precompression of the spring elements; if this is not done, achieving initial equilibrium under gravity loading can be very time consuming.

The \*RAIL algorithm ensures that the train follows the rails, but does not provide forward motion. This is generally applied using \*INITIAL\_VELOCITY, or for straight tracks, \*BOUNDARY\_PRESCRIBED\_MOTION.

### **Output**

LS-DYNA generates an additional ASCII output file **train\_force\_n**, where **n** is an integer updated to avoid overwriting any existing files. The file contains the forces on each train node, output at the same time intervals as the binary time history file (DT on \*DATABASE\_BINARY\_D3THDT).

### **Checking**

It is recommended that track and train models be tested separately before adding the \*RAIL cards. Check that the models respond stably to impulse forces and that they achieve equilibrium under gravity loading. The majority of problems we have encountered have been due to unstable behavior of train or track. Often, these are first detected by the \*RAIL algorithm and an error message will result.

**\*RAIL\_TRAIN**

Purpose: Define train properties. A train is defined by a set of nodes in contact with a rail defined by \*RAIL\_TRACK.

Card 1            1            2            3            4            5            6            7            8

Variable	ID	NSETID	(omit)	FINIT	(omit)	TRID	LCUR	OFFS
Type	I	I	F	F	F	I	I	F
Default	none	None	0.0	0.0	0.0	0	None	0.0

Card 2            1            2            3            4            5            6            7            8

Variable	VERTSTF	LATSTF	V2	V3	L2	L3		
Type	F	F	F	F	F	F		
Default	0.0	0.0	0.0	0.0	0.0	0.0		

<u>VARIABLE</u>	<u>DESCRIPTION</u>
ID	Train ID
NSETID	Node set ID containing all nodes that are in contact with rails.
(omit)	Unused variable – leave blank.
FINIT	Estimate of initial vertical force on each wheel (optional) – speeds up the process of initial settling down under gravity loading.
(omit)	Unused variable – leave blank.
TRID	ID of track for this train, see *RAIL_TRACK.

---

<b>VARIABLE</b>	<b>DESCRIPTION</b>
LCUR	Load curve ID (see *DEFINE_CURVE) containing wheel roughness (distance of wheel surface away from perfect circle) vs. distance traveled. The curve does not repeat with each rotation of the wheel – the last point should be at a greater distance than the train is expected to travel. Default: no wheel roughness.
OFFS	Offset distance used to generate different roughness curves for each wheel from the roughness curve LCUR. The curve is offset on the x-axis by a different whole number multiple of OFFS for each wheel.
VERTSTF	Vertical stiffness of rail contact.
LATSTF	Lateral stiffness of rail contact.
V2,V3	Unused variables – leave blank.
L2	Lateral clearance from rail to wheel rim. Lateral force is applied to a wheel only when it has moved more than L2 away from the other rail, i.e. the wheel rims are assumed to be near the inner face of the rail.
L3	Further lateral distance before full lateral stiffness applies (force-deflection curve follows a parabola up to this point).



# **\*RIGIDWALL**

Two keywords are used in this section to define rigid surfaces:

**\*RIGIDWALL\_GEOMETRIC\_OPTION\_{OPTION}\_{OPTION}}\_{OPTION}**

**\*RIGIDWALL\_PLANAR\_{OPTION}\_{OPTION}}\_{OPTION}**

The RIGIDWALL option provides a simple way of treating contact between a rigid surface and nodal points of a deformable body, called slave nodes. Slave nodes which belong to rigid parts are not, in general, checked for contact with only one exception. The RIGIDWALL\_PLANAR option may be used with nodal points of rigid bodies if the planar wall defined by this option is fixed in space and the RWPNAL parameter is set to a positive nonzero value on the control card, \*CONTROL\_CONTACT.

When the rigid wall defined in this section moves with a prescribed motion, the equations of rigid body mechanics are not involved. For a general rigid body treatment with arbitrary surfaces and motion, refer to the \*CONTACT\_ENTITY definition. The \*CONTACT\_ENTITY option is for treating contact between rigid and deformable surfaces only.

Energy dissipated due to rigidwalls (sometimes called stonewall energy or rigidwall energy) is computed only if the parameter RWEN is set to 2 in \*CONTROL\_ENERGY.



<u>VARIABLE</u>	<u>DESCRIPTION</u>
RWID	Rigid wall ID. This must be a unique number.
HEADING	Rigid wall descriptor. It is suggested that unique descriptions be used.

**For GEOMETRIC options:**

- Cards 1 and 2 are required for all geometric shapes.
- Card 3 is required, but is dependent upon which shape is specified.
- Optional Card A is required if MOTION is specified.

**Card 1 - Required for all shape types**

Card 1            1            2            3            4            5            6            7            8

Variable	NSID	NSIDEX	BOXID	BIRTH	DEATH			
Type	I	I	I	F	F			
Default	none	0	0	0.	1.0E+20			

<u>VARIABLE</u>	<u>DESCRIPTION</u>
NSID	Nodal set ID containing slave nodes, see *SET_NODE_OPTION: EQ.0: all nodes are slave to rigid wall.
NSIDEX	Nodal set ID containing nodes that exempted as slave nodes, see *SET_NODE_OPTION.
BOXID	If defined, only nodes in box are included as slave nodes to rigid wall.
BIRTH	Birth time of rigid wall. The time values of the load curves that control the motion of the wall are offset by the birth time.
DEATH	Death time of rigid wall. At this time the wall is deleted from the calculation. If dynamic relaxation is active at the beginning of the calculation and if BIRTH=0.0, the death time is ignored during the dynamic relaxation.

**Card 2 - Required for all shape types.**

Card 2            1            2            3            4            5            6            7            8

Variable	XT	YT	ZT	XH	YH	ZH	FRIC	
Type	F	F	F	F	F	F	F	
Default	0.	0.	0.	0.	0.	0.	0.	
Remarks								

**VARIABLE****DESCRIPTION**

XT	x-coordinate of tail of any outward drawn normal vector, <b>n</b> , originating on wall (tail) and terminating in space (head), see Figure 31.1.
YT	y-coordinate of tail of normal vector <b>n</b>
ZT	z-coordinate of tail of normal vector <b>n</b>
XH	x-coordinate of head of normal vector <b>n</b>
YH	y-coordinate of head of normal vector <b>n</b>
ZH	z-coordinate of head of normal vector <b>n</b>
FRIC	Interface friction: EQ.0.0: frictionless sliding after contact, EQ.1.0: stick condition after contact,

**Card 3 - Required if FLAT is specified after the keyword.**

A plane with a finite size or with an infinite size can be defined, see Figure 31.1. The vector **m** is computed as the vector cross product  $\mathbf{n} \times \mathbf{l}$ . The origin, which is the tail of the normal vector, is the corner point of the finite size plane.

Card 3            1            2            3            4            5            6            7            8

Variable	XHEV	YHEV	ZHEV	LENL	LENM			
Type	F	F	F	F	F			
Default	0.	0.	0.	infinity	infinity			

**VARIABLE****DESCRIPTION**

XHEV	x-coordinate of head of edge vector <b>l</b> , see Figure 31.1.
YHEV	y-coordinate of head of edge vector <b>l</b>
ZHEV	z-coordinate of head of edge vector <b>l</b>
LENL	Length of <b>l</b> edge. A zero value defines an infinite size plane.
LENM	Length of <b>m</b> edge. A zero value defines an infinite size plane.

**Card 3 - Required if PRISM is specified after the keyword.**

The description of the definition of a plane with finite size is enhanced by an additional length in the direction negative to **n**, see Figure 31.1.

Card 3            1            2            3            4            5            6            7            8

Variable	XHEV	YHEV	ZHEV	LENL	LENM	LENP		
Type	F	F	F	F	F	F		
Default	none	0.	0.	infinity	infinity	infinity		

<u>VARIABLE</u>	<u>DESCRIPTION</u>
XHEV	x-coordinate of head of edge vector <b>l</b> , see Figure 31.1.
YHEV	y-coordinate of head of edge vector <b>l</b>
ZHEV	z-coordinate of head of edge vector <b>l</b>
LENL	Length of <b>l</b> edge. A zero value defines an infinite size plane.
LENM	Length of <b>m</b> edge. A zero value defines an infinite size plane.
LENP	Length of prism in the direction negative to <b>n</b> , see Figure 31.1.

**Card 3 - Required if CYLINDER is specified after the keyword.**

The tail of **n** specifies the top plane of the cylinder. The length is defined in the direction negative to **n**. See Figure 31.1.

Card 3            1            2            3            4            5            6            7            8

Variable	RADCYL	LENCYL						
Type	F	F						
Default	none	infinity						

<u>VARIABLE</u>	<u>DESCRIPTION</u>
RADCYL	Radius of cylinder
LENCYL	Length of cylinder, see Figure 31.1. Only if a value larger than zero is specified is a finite length assumed.

**Card 3 - Required if SPHERE is specified after the keyword.** The center of the sphere is identical to the tail of **n**, see Figure 31.1.

Card 3            1            2            3            4            5            6            7            8

Variable	RADSPH							
Type	F							
Default	0.							

<u>VARIABLE</u>	<u>DESCRIPTION</u>							
RADSPH	Radius of sphere							

**Optional Card A - Required if MOTION is specified after the keyword.**

Optional Card A            1            2            3            4            5            6            7            8

Variable	LCID	OPT	VX	VY	VZ			
Type	I	I	F	F	F			
Default	none	none	none	none	none			

<u>VARIABLE</u>	<u>DESCRIPTION</u>							
LCID	Rigidwall motion curve number, see *DEFINE_CURVE.							
OPT	Type of motion: EQ.0: velocity specified, EQ.1: displacement specified.							
VX	x-direction cosine of velocity/displacement vector							
VY	y-direction cosine of velocity/displacement vector							
VZ	z-direction cosine of velocity/displacement vector							

# \*RIGIDWALL

# \*RIGIDWALL\_GEOMETRIC

**Optional Card B – Not required, but may be useful if the DISPLAY option is specified. If a “\*” keyword is defined, this input is not read in and default values will be set.**

Card 1            1            2            3            4            5            6            7            8

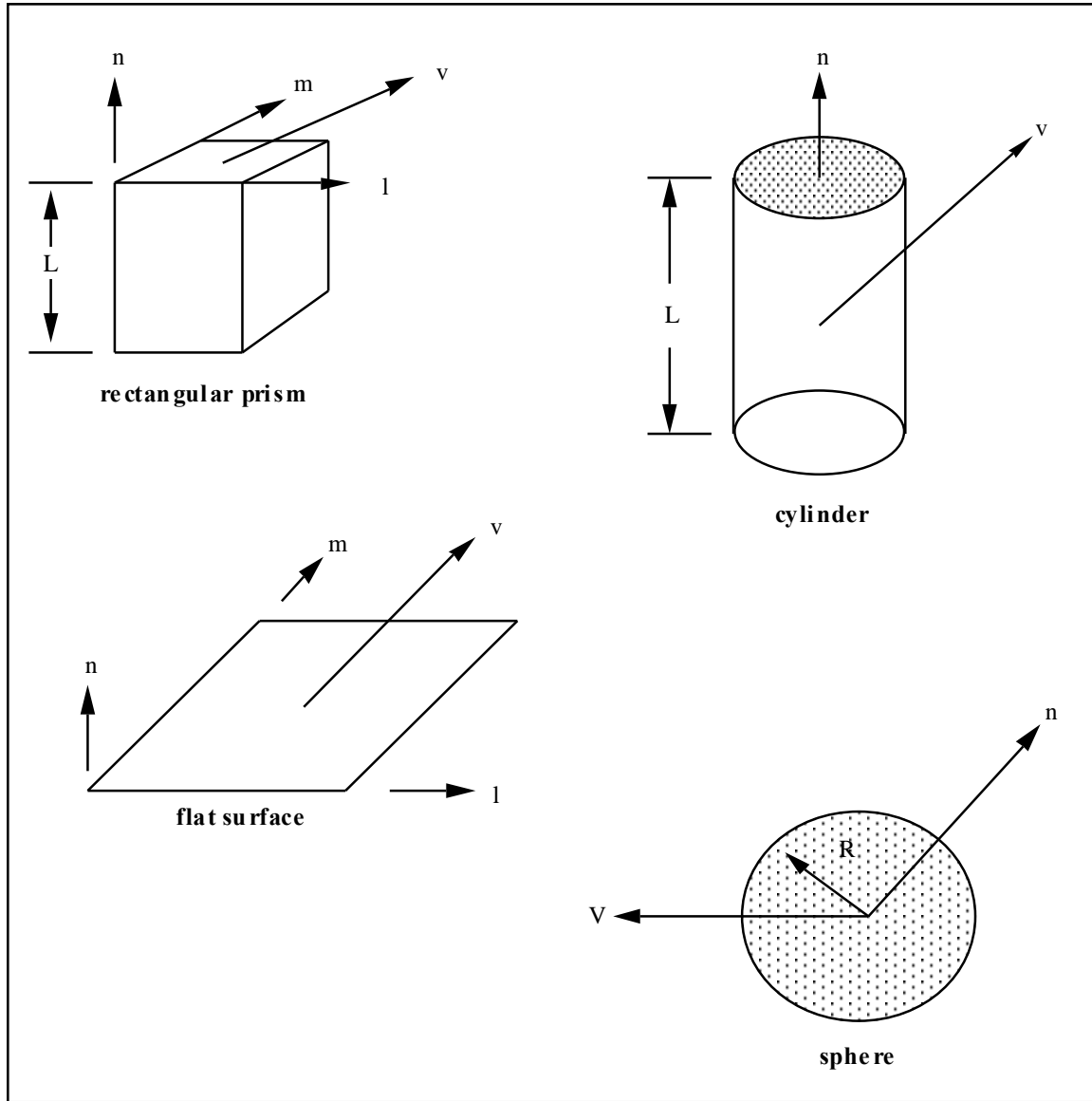
Variable	PID	RO	E	PR				
Type	I	I	I	F				
Default	none	0	0	0.				

## VARIABLE

## DESCRIPTION

PID	Unique part ID for moving geometric rigid wall. If zero, a part ID will be set that is larger than the maximum of all user defined part ID's.
RO	Density of rigid wall. The default is set to 1.0E-09.
E	Young's modulus. The default is set to 1.0E-04.
PR	Poisson's ratio. The default is set to 0.30.





**Figure 31.1.** Vector  $\mathbf{n}$  determines the orientation of the generalized rigidwalls. For the prescribed motion options the wall can be moved in the direction  $\mathbf{V}$  as shown.

```

$$$$$$$$$$$$$$$$$$$$$$$$$$$$$$$$$$$$$$$$$$$$$$$$$$$$$$$$$$$$$$$$$$$$$$$$$$$$$$$$$$$$
$
$$$ $ *RIGIDWALL_GEOMETRIC_SPHERE_MOTION
$
$$$$$$$$$$$$$$$$$$$$$$$$$$$$$$$$$$$$$$$$$$$$$$$$$$$$$$$$$$$$$$$$$$$$$$$$$$$$$$$$$$$$
$
$ Define a rigid sphere:
$   - with a radius of 8
$   - centered at (x,y,z) = (20,20,9)
$   - that moves in the negative z-direction with a specified displacement
$     given by a load curve (load curve: lcid = 5)
$   - which prevents all nodes within a specified box from penetrating the
$     sphere (box number: boxid = 3), these nodes can slide on the sphere
$     without friction
$
*$RIGIDWALL_GEOMETRIC_SPHERE_MOTION
$.>...>...1.>...>...2.>...>...3.>...>...4.>...>...5.>...>...6.>...>...7.>...>...8
$   nsid   nsindex   boxid
$           3
$
$   xt      yt      zt      xh      yh      zh      fric
$   20.0    20.0    9.0     20.0    20.0    0.0     0.0
$
$   radsph
$   8.0
$
$   lcid     opt     vx     vy     vz
$   5        1      0.0    0.0   -1.0
$
$
*$DEFINE_BOX
$   boxid   xmn     xmx     ymn     ymx     zmn     zmx
$   3       0.0    40.0    0.0    40.0   -1.0    1.0
$
$
*$DEFINE_CURVE
$   lcid     sidr     scla     sclo     offa     offo
$   5
$
$       abscissa          ordinate
$           0.0           0.0
$           0.0005        15.0
$
$$$$$$$$$$$$$$$$$$$$$$$$$$$$$$$$$$$$$$$$$$$$$$$$$$$$$$$$$$$$$$$$$$$$$$$$$$$$$$$$$$$$

```

**\*RIGIDWALL\_PLANAR\_{OPTION}\_{OPTION}\_{OPTION}**

Available options include:

<**BLANK**>**ORTHO****FINITE****MOVING****FORCES**

The ordering of the options in the input below must be observed but the ordering of the options on the command line is unimportant, i.e.; the **ORTHO** card is first, the **FINITE** definition card below must precede the **MOVING** definition card, and the **FORCES** definition card should be last. The **ORTHO** option does not apply if the **MOVING** option is used. If an ID number is specified the additional option is available:

**ID**

If active, the ID card is the first card following the keyword. To view the rigid wall, the option:

**DISPLAY**

is available. With this option a rigid body is automatically defined which represents the shape, the physical position of the wall, and follows the walls motion if the **MOVING** option is active. No additional input is optional if **DISPLAY** is active for the **PLANAR** wall. . The part ID of the rigid wall defaults to **RWID** if the **ID** option is active, and if **RWID** is a unique ID within the set of all part ID's.

Purpose: Define planar rigid walls with either finite (**FINITE**) or infinite size. Orthotropic friction can be defined (**ORTHO**). Also, the plane can possess a mass and an initial velocity (**MOVING**); otherwise, the wall is assumed to be stationary. The **FORCES** option allows the specification of segments on the rigid walls on which the contact forces are computed. In order to achieve a more physical reaction related to the force versus time curve, the **SOFT** value on the **FORCES** card can be specified.

**ID Card Define if and only if ID option is active.**

Card 1            1            2            3            4            5            6            7            8

Variable	RWID							
Type	I							
Default	none							

**VARIABLE****DESCRIPTION**

RWID                                      Rigid wall ID. Up to 8 characters can be used.

- Cards 1 and 2 are required.
- Optional Cards A and B are required if ORTHO is specified.
- Optional Card C is required if FINITE is specified.
- Optional Card D is required if MOVING is specified.
- Optional Card E is required if FORCES is specified.

**Required.**

Card 1            1            2            3            4            5            6            7            8

Variable	NSID	NSIDEX	BOXID	OFFSET	BIRTH	DEATH	RWKSF	
Type	I	I	I	F	F	F	F	
Default	none	0	0	0.	0.	1.0E+20	1.0	

**VARIABLE****DESCRIPTION**

NSID                                      Nodal set ID containing slave nodes, see \*SET\_NODE\_OPTION:  
EQ.0: all nodes are slave to rigid wall.

NSIDEX                                    Nodal set ID containing nodes that exempted as slave nodes, see \*SET\_NODE\_OPTION.

BOXID                                    All nodes in box are included as slave nodes to rigid wall, see \*DEFINE\_BOX. If options NSID or NSIDEX are active then only the

VARIABLE	DESCRIPTION
	subset of nodes activated by these options are checked to see if they are within the box.
OFFSET	All nodes within a normal offset distance, OFFSET, to the rigid wall are included as slave nodes for the rigid wall. If options NSID, NSIDEX, or BOXID are active then only the subset of nodes activated by these options are checked to see if they are within the offset distance. This option applies to the PLANAR wall only.
BIRTH	Birth time of rigid wall. The time values of the load curves that control the motion of the wall are offset by the birth time.
DEATH	Death time of rigid wall. At this time the wall is deleted from the calculation. If dynamic relaxation is active at the beginning of the calculation and if BIRTH=0.0, the death time is ignored during the dynamic relaxation.
RWKSF	Stiffness scaling factor. If RWKSF is also specified in *CONTROL_CONTACT, the stiffness is scaled by the product of the two values.

**Required.**

Card 2	1	2	3	4	5	6	7	8
Variable	XT	YT	ZT	XH	YH	ZH	FRIC	WVEL
Type	F	F	F	F	F	F	F	F
Default	0.	0.	0.	0.	0.	0.	0.	0.

VARIABLE	DESCRIPTION
XT	x-coordinate of tail of any outward drawn normal vector, <b>n</b> , originating on wall (tail) and terminating in space (head), see Figure 31.3.
YT	y-coordinate of tail of normal vector <b>n</b>
ZT	z-coordinate of tail of normal vector <b>n</b>
XH	x-coordinate of head of normal vector <b>n</b>
YH	y-coordinate of head of normal vector <b>n</b>

<u>VARIABLE</u>	<u>DESCRIPTION</u>
-----------------	--------------------

ZH	z-coordinate of head of normal vector <b>n</b>
----	--

FRIC	Interface friction: EQ.0.0: frictionless sliding after contact, EQ.1.0: no sliding after contact, EQ.2.0: node is welded after contact with frictionless sliding. Welding occurs if and only if the normal value of the impact velocity exceeds the critical value specified by WVEL. EQ.3.0: node is welded after contact with no sliding. Welding occurs if and only if the normal value of the impact velocity exceeds the critical value specified by WVEL.
------	---

In summary, FRIC could be any positive value. Three special values of FRIC trigger special treatments as follows:

FRIC	1.0	2.0	3.0
Bouncing back from wall	allowed	not allowed	not allowed
Sliding on wall	not allowed	allowed	not allowed

WVEL	Critical normal velocity at which nodes weld to wall (FRIC = 2 or 3).
------	---

**Optional Cards A and B - Required if ORTHO is specified after the keyword.**

See Figure 31.2 for the definition of orthotropic friction.

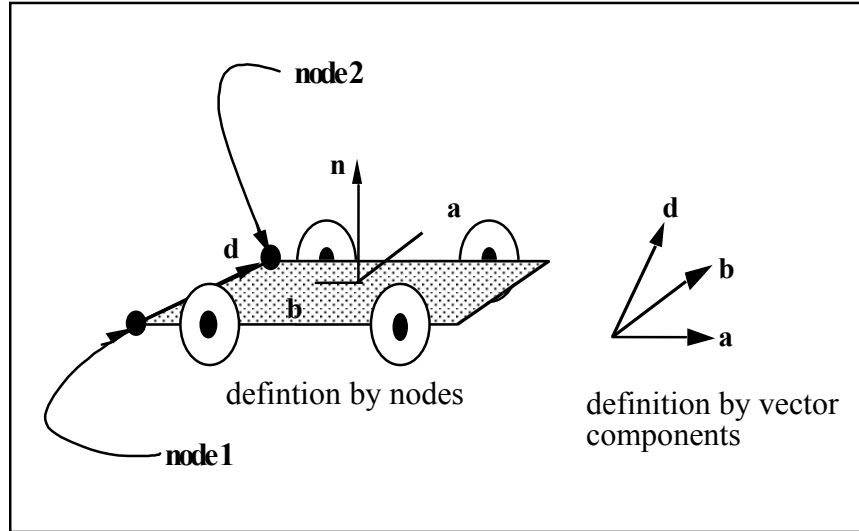
Optional Card A	1	2	3	4	5	6	7	8
-----------------	---	---	---	---	---	---	---	---

Variable	SFRICA	SFRICB	DFRICA	DFRICB	DECAYA	DECAYB		
Type	F	F	F	F	F	F		
Default	0.	0.	0	0	0.	0.		

Optional Card B	1	2	3	4	5	6	7	8
--------------------	---	---	---	---	---	---	---	---

Variable	NODE1	NODE2	D1	D2	D3			
Type	I	I	F	F	F			
Default	0.	0.	0	0	0.			

<u>VARIABLE</u>	<u>DESCRIPTION</u>
SFRICA	Static friction coefficient in local a-direction, $\mu_{sa}$ , see Figure 31.2
SFRICB	Static friction coefficient in local b-direction, $\mu_{sb}$
DFRICA	Dynamic friction coefficient in local a-direction, $\mu_{ka}$
DFRICB	Dynamic friction coefficient in local b-direction, $\mu_{kb}$
DECAYA	Decay constant in local a-direction, $d_{va}$
DECAYB	Decay constant in local b-direction, $d_{vb}$
NODE1	Node 1, alternative to definition with vector d below. See Figure 31.2. With the node definition the direction changes if the nodal pair rotates.
NODE2	Node 2
D1	$d_1$ , x-component of vector, alternative to definition with nodes above. See Figure 31.2. This vector is fixed as a function of time.
D2	$d_2$ , y-component of vector
D3	$d_3$ , z-component of vector



**Figure 31.2.** Definition of orthotropic friction vectors. The two methods of defining the vector, **d**, are shown. If vector **d** is defined by nodes 1 and 2, the local coordinate system may rotate with the body which contains the nodes; otherwise, **d** is fixed in space, thus on the rigid wall, and the local system is stationary.

**Remarks:**

1. The coefficients of friction are defined in terms of the static, dynamic and decay coefficients and the relative velocities in the local a and b directions as

$$\mu_a = \mu_{ka} + (\mu_{sa} \mu_{ka}) e^{d_{va} V_{relative,a}}$$

$$\mu_b = \mu_{kb} + (\mu_{sb} \mu_{kb}) e^{d_{vb} V_{relative,b}}$$

2. Orthotropic rigid walls can be used to model rolling objects on rigid walls where the frictional forces are substantially higher in a direction transverse to the rolling direction. To use this option define a vector **d** to determine the local frictional directions via:

$$b = n \times d \text{ and that } a = b \times n$$

where **n** is the normal vector to the rigid wall. If **d** is in the plane of the rigid wall, then **a** is identical to **d**.



**Optional Card C - Required if FINITE is specified after the keyword.**

See Figure 31.3. The **m** vector is computed as the vector cross product  $\mathbf{m} = \mathbf{n} \times \mathbf{l}$ . The origin, the tail of the normal vector, is taken as the corner point of the finite size plane.

Optional Card C            1            2            3            4            5            6            7            8

Variable	XHEV	YHEV	ZHEV	LENL	LENM			
Type	F	F	F	F	F			
Default	0.	0.	0.	infinity	infinity			

**VARIABLE**

**DESCRIPTION**

- XHEV            x-coordinate of head of edge vector **l**, see Figure 31.3.
- YHEV            y-coordinate of head of edge vector **l**
- ZHEV            z-coordinate of head of edge vector **l**
- LENL            Length of **l** edge
- LENM            Length of **m** edge

**Optional Card D - Required if MOVING is specified after keyword.Note:**

The MOVING option is not compatible with the ORTHO option.

Optional Card D            1            2            3            4            5            6            7            8

Variable	MASS	V0						
Type	F	F						
Default	none	0.						

<u>VARIABLE</u>	<u>DESCRIPTION</u>
MASS	Total mass of rigidwall
V0	Initial velocity of rigidwall in direction of defining vector, <b>n</b>

**Optional Card E - Required if FORCES is specified after the keyword.**

This option allows the force distribution to be monitored on the plane. Also four points can be defined for visualization of the rigid wall. A shell or membrane element must be defined with these four points as the connectivity for viewing in LS-PREPOST.

Optional Card E      1            2            3            4            5            6            7            8

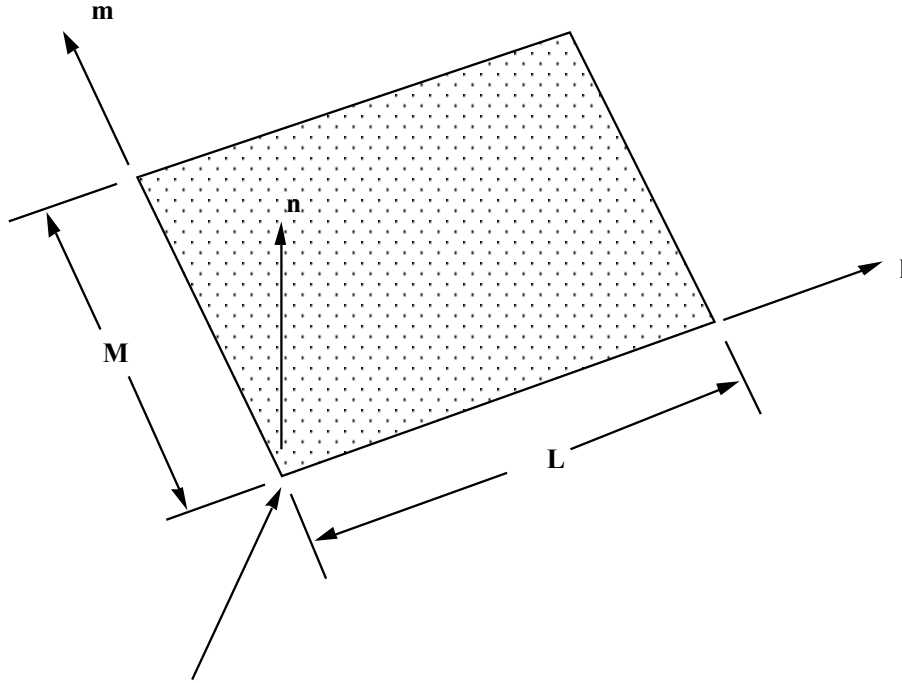
Variable	SOFT	SSID	N1	N2	N3	N4		
Type	I	I	I	I	I	I		
Default	0	0	0	0	0	0		
Remarks		1	2					

<u>VARIABLE</u>	<u>DESCRIPTION</u>
SOFT	Number of cycles to zero relative velocity to reduce force spike
SSID	Segment set identification number for defining areas for force output, see *SET_SEGMENT and remark 1 below.
N1-N4	Optional node for visualization

**Remarks:**

1. The segment set defines areas for computing resultant forces. These segments translate with the moving rigidwall and allow the forced distribution to be determined. The resultant forces are written in file "RWFORC."
2. These four nodes are for visualizing the movement of the wall, i.e., they move with the wall. To view the wall in LS-PREPOST it is necessary to define a single shell element with these four nodes as its connectivity. The single element must be deformable (non

rigid) or else the segment will be treated as a rigid body and the nodes will have their motion modified independently of the rigidwall.



Tail of normal vector is the origin and corner point if extent of stonewall is finite.

**Figure 31.3.** Vector **n** is normal to the rigidwall. An optional vector **I** can be defined such that  $\mathbf{m} = \mathbf{n} \times \mathbf{I}$ . The extent of the rigidwall is limited by defining **L** (LENL) and **M** (LENM). A zero value for either of these lengths indicates that the rigidwall is infinite in that direction.

```

$$$$$$$$$$$$$$$$$$$$$$$$$$$$$$$$$$$$$$$$$$$$$$$$$$$$$$$$$$$$$$$$$$$$$$$$$$$$$$$$$$$$
$
$$$ *RIGIDWALL_PLANAR_MOVING_FORCES
$
$$$$$$$$$$$$$$$$$$$$$$$$$$$$$$$$$$$$$$$$$$$$$$$$$$$$$$$$$$$$$$$$$$$$$$$$$$$$$$$$$$$$
$
$ Define a moving planar rigid wall:
$   - that is parallel to the y-z plane starting at x = 250 mm
$   - with an initial velocity of 8.94 mm/ms in the negative z-direction
$   - that has a mass of 800 kg
$   - which prevents all nodes in the model from penetrating the wall
$   - with a friction coefficient for nodes sliding along the wall of 0.1
$   - track the motion of the wall by creating a node (numbered 99999)
$     at the tail of the wall and assigning the node to move with the wall
$

```



# **\*SECTION**

In this section, the element formulation, integration rule, nodal thicknesses, and cross sectional properties are defined. All section identifiers (SECID's) defined in this section must be unique, i.e., if a number is used as a section ID for a beam element then this number cannot be used again as a section ID for a solid element. The keyword cards in this section are defined in alphabetical order:

**\*SECTION\_ALE1D**

**\*SECTION\_ALE2D**

**\*SECTION\_BEAM\_{OPTION}**

**\*SECTION\_DISCRETE**

**\*SECTION\_POINT\_SOURCE**

**\*SECTION\_POINT\_SOURCE\_MIXTURE**

**\*SECTION\_SEATBELT**

**\*SECTION\_SHELL\_{OPTION}**

**\*SECTION\_SOLID\_{OPTION}**

**\*SECTION\_SPH\_{OPTION}**

**\*SECTION\_TSHELL**

The location and order of these cards in the input file are arbitrary.

An additional option **\_TITLE** may be appended to all the **\*SECTION** keywords. If this option is used then an addition line is read for each section in 80a format which can be used to describe the section. At present LS-DYNA does not make use of the title. Inclusion of titles gives greater clarity to input decks.

# \*SECTION

\*SECTION\_ALE1D

## \*SECTION\_ALE1D

Purpose: Define section properties for 1D ALE elements

Card 1            1            2            3            4            5            6            7            8

Variable	SECID	ALEFORM	AET	ELFORM				
Type	I	I	I	I				
Default	none	none	0	none				

Card 2            1            2            3            4            5            6            7            8

Variable	THICK	THICK						
Type	F	F						
Default	none	none						

### VARIABLE

### DESCRIPTION

SECID	Section ID. SECID is referenced on the *PART card and must be unique
ALEFORM	ALE formulation: EQ.11: Multi-Material ALE formulation
AET	Ambient Element Type EQ.4: Pressure inflow
ELFORM	Element formulation: EQ.7: Plane strain (x-y plane, element volume = 1*dx*THICK) EQ.8: Axisymmetric (y-axis of symmetry, element volume= x*dx*THICK) EQ.-8: spherical (element volume= x*x*dx)
THICK	Thickness. See Remark 1

**Remarks:**

1. The thickness is read twice as \*SECTION\_ALE1D uses the same thickness parameters than \*SECTION\_BEAM. The thickness is not used for ELFORM=-8 but the reader routine expects values on the 2<sup>nd</sup> line

**\*SECTION\_ALE2D**

Purpose: Define section properties for 2D ALE elements

Card 1            1            2            3            4            5            6            7            8

Variable	SECID	ALEFORM	AET	ELFORM				
Type	I	I	I	I				
Default	none	none	0	none				

**VARIABLE****DESCRIPTION**

SECID

Section ID. SECID is referenced on the \*PART card and must be unique

ALEFORM

ALE formulation:

EQ.6 : Single material Eulerian formulation

EQ.11: Multi-Material ALE formulation

AET

Ambient Element Type

EQ.4: Pressure inflow

EQ.5: receptor for blast load (see \*LOAD\_BLAST\_ENHANCED, available only for ALEFORM=11).

ELFORM

Element formulation:

EQ.13: Plane strain (x-y plane)

EQ.14: Axisymmetric solid (y-axis of symmetry) – area weighted



**\*SECTION\_BEAM****\*SECTION****\*SECTION\_BEAM\_{OPTION}**

Available options include:

<BLANK>

AISC

such that the keyword cards appear:

**\*SECTION\_BEAM**

**\*SECTION\_BEAM\_AISC**

Purpose: Define cross sectional properties for beam, truss, discrete beam, and cable elements.

The AISC option may be used to specify standard steel sections as specified by the American Institute of Steel Construction, and is described separately after \*SECTION\_BEAM

Card 1            1            2            3            4            5            6            7            8

Variable	SECID	ELFORM	SHRF	QR/IRID	CST	SCOOR	NSM	
Type	A8	I	F	F	F	F	F	
Default	none	1	1.0	2.0	0.0	0.0	0.0	

**Define the appropriate card format depending on the value of ELFORM (1-9) above.**

Card 2            1            2            3            4            5            6            7            8

Integrated beam type 1,11	TS1	TS2	TT1	TT2	NSLOC	NTLOC		
Resultant 2, 13	A	ISS	ITT	J	SA	IST		
Truss 3	A	RAMPT	STRESS					
Resultant 2,3, and 12 alternative	STYPE	D1	D2	D3	D4	D5	D6	
Integrated beam type 4,5	TS1	TS2	TT1	TT2				

**\*SECTION****\*SECTION\_BEAM**

Card 2            1            2            3            4            5            6            7            8

Discrete 6	VOL	INER	CID	CA	OFFSET	RRCON	SRCON	TRCON
Scalar 6 (mat_146)	VOL	INER	CID	DOFN1	DOFN2			
2D shells 7,8	TS1	TS2	TT1	TT2				
Spot weld 9	TS1	TS2	TT1	TT2	PRINT			
Resultant 12 1st card	A	ISS	ITT	J	SA	IST		
Resultant 12 2nd card	YS	ZS	IYR	IZR	IRR	IW	IWR	
Type	A & F	F	F	F	F	F	F	F

**VARIABLE****DESCRIPTION**

SECID

Section ID. SECID is referenced on the \*PART card. A unique number or label not exceeding 8 characters must be specified.

VARIABLE	DESCRIPTION
ELFORM	<p>Element formulation options:</p> <ul style="list-style-type: none"><li>EQ.1: Hughes-Liu with cross section integration (default),</li><li>EQ.2: Belytschko-Schwer resultant beam (resultant),</li><li>EQ.3: truss (resultant), see remark 2.</li><li>EQ.4: Belytschko-Schwer full cross-section integration,</li><li>EQ.5: Belytschko-Schwer tubular beam with cross-section integration,</li><li>EQ.6: discrete beam/cable,</li><li>EQ.7: 2D plane strain shell element (xy plane),</li><li>EQ.8: 2D axisymmetric volume weighted shell element (xy plane),</li><li>EQ.9: spotweld beam, see *MAT_SPOTWELD.</li><li>EQ.11: integrated warped beam</li><li>EQ.12: resultant warped beam</li><li>EQ.13: small displacement, linear Timoshenko beam with exact stiffness.</li></ul> <p>Note that the 2D and 3D element types must not be mixed, and different types of 2D elements must not be used together. For example, the plane strain element type must not be used with the axisymmetric element type. In 3D the different beam elements types, i.e., 1-6 and 9 can be freely mixed together.</p>
SHRF	<p>Shear factor. This factor is not needed for truss, resultant beam, discrete beam, and cable elements. The recommended value for rectangular sections is 5/6, the default is 1.0.</p>
QR/IRID	<p>Quadrature rule or rule number for user defined rule for integrated beams:</p> <ul style="list-style-type: none"><li>EQ.1.0: one integration point,</li><li>EQ.2.0: 2×2 Gauss quadrature (default beam),</li><li>EQ.3.0: 3×3 Gauss quadrature,</li><li>EQ.4.0: 3×3 Lobatto quadrature,</li><li>EQ.5.0: 4×4 Gauss quadrature</li><li>EQ.-n: where  n  is the number of the user defined rule. IRID integration rule n is defined using *INTEGRATION_BEAM card.</li></ul>
CST	<p>Cross section type, not needed for truss, resultant beam, discrete beam, and cable elements:</p> <ul style="list-style-type: none"><li>EQ.0.0: rectangular,</li><li>EQ.1.0: tubular (circular only),</li><li>EQ.2.0: arbitrary (user defined integration rule).</li></ul>

<b>VARIABLE</b>	<b>DESCRIPTION</b>
SCoor	<p>Affects the discrete beam formulation (see Remark 7) and also the update of the local coordinate system of the discrete beam element. This parameter does not apply to cable elements. The force and moment resultants in the output databases are output in the local coordinate system. See Remark 9 for more on the local coordinate system update.</p> <p>EQ.-3.0: beam node 1, the angular velocity of node 1 rotates triad,  EQ.-2.0: beam node 1, the angular velocity of node 1 rotates triad but the r-axis is adjusted to lie along the line between the two beam nodal points. This option is not recommended for zero length discrete beams.,  EQ.-1.0: beam node 1, the angular velocity of node 1 rotates triad,  EQ. 0.0: centered between beam nodes 1 and 2, the average angular velocity of nodes 1 and 2 is used to rotate the triad,  EQ.+1.0: beam node 2, the angular velocity of node 2 rotates triad.  EQ.+2.0: beam node 2, the angular velocity of node 2 rotates triad. but the r-axis is adjusted to lie along the line between the two beam nodal points. This option is not recommended for zero length discrete beams.  EQ.+3.0: beam node 2, the angular velocity of node 2 rotates triad.</p>
NSM	Nonstructural mass per unit length. This option applies to beam types 1-5 and does not apply to discrete, 2D, and spotweld beams, respectively.
TS1	Beam thickness (CST=0.0, 2.0) or outer diameter (CST = 1.0) in s direction at node n <sub>1</sub> . Note that the thickness defined on the *ELEMENT_BEAM_THICKNESS card overrides the definition give here.
TS2	Beam thickness (CST=0.0, 2.0) or outer diameter (CST = 1.0) in s direction at node n <sub>2</sub> . For truss elements only, it is the ramp up time for the stress initialization by dynamic relaxation.
TT1	Beam thickness (CST=0.0, 2.0) or inner diameter (CST = 1.0) in t direction at node n <sub>1</sub> . For truss elements only, it is the stress for the initialization of the stress by dynamic relaxation.
TT2	Beam thickness (CST=0.0, 2.0) or inner diameter (CST = 1.0) in t direction at node n <sub>2</sub> .
NSLOC	<p>Location of reference surface normal to s axis for Hughes-Liu beam elements only. See Remark 5.</p> <p>EQ.1.0: side at s = 1.0,  EQ.0.0: center,  EQ.-1.0: side at s = -1.0.</p>

VARIABLE	DESCRIPTION
NTLOC	Location of reference surface normal to t axis for Hughes-Liu beam elements only. See Remark 5. EQ.1.0: side at t = 1.0, EQ.0.0: center, EQ.-1.0: side at t = -1.0.
A	Cross-sectional area. The definition on *ELEMENT_BEAM_THICKNESS overrides the value defined here, see Figure 32.1.
ISS	$I_{ss}$ , moment of inertia about local s-axis. The definition on *ELEMENT_BEAM_THICKNESS overrides the value defined here, see Figure 32.1.
ITT	$I_{tt}$ , moment of inertia about local t-axis. The definition on *ELEMENT_BEAM_THICKNESS overrides the value defined here, see Figure 32.1.
J	J, torsional constant. The definition on *ELEMENT_BEAM_THICKNESS overrides the value defined here, see Figure 32.1. If J is zero, then J is reset to the sum of ISS+ITT as an approximation for warped beam.
SA	Shear area. The definition on *ELEMENT_BEAM_THICKNESS overrides the value defined here, see Figure 32.1.
IST	$I_{st}$ , product moment of inertia w.r.t. local s- and t-axis. This is only non-zero for unsymmetric cross sections and it can take positive and negative values, e.g. it is negative for SECTION_03.
YS	s coordinate of sheer center of cross-section. (The coordinate system is located at the centroid.)
ZS	t coordinate of sheer center of cross-section. (The coordinate system is located at the centroid.)
IYR	$\int_A s \cdot r^2 dA$ , where $r^2 = s^2 + t^2$
IZR	$\int_A t \cdot r^2 dA$ , where $r^2 = s^2 + t^2$
IRR	$\int_A r^4 dA$ , where $r^2 = s^2 + t^2$
IW	Warping constant. $\int_A \omega^2 dA$ , where $\omega$ is the sectorial area.

<b>VARIABLE</b>	<b>DESCRIPTION</b>
IWR	$\int_A \omega r^2 dA$
RAMPT	Optional ramp-up time for dynamic relaxation. At the end of the ramp-up time, a uniform stress, STRESS, will exist in the truss element. This option will not work for hyperelastic materials.
STRESS	Optional initial stress for dynamic relaxation. At the end of dynamic relaxation a uniform stress equal to this value should exist in the truss element.
STYPE	Section type (A format): EQ.SECTION_01: I-shape            EQ.SECTION_12: Cross EQ.SECTION_02: Channel        EQ.SECTION_13: H-shape EQ.SECTION_03: L-shape        EQ.SECTION_14: T-shape1 EQ.SECTION_04: T-shape        EQ.SECTION_15: I-shape2 EQ.SECTION_05: Tubular box   EQ.SECTION_16: Channel1 EQ.SECTION_06: Z-shape        EQ.SECTION_17: Channel2 EQ.SECTION_07: Trapezoidal   EQ.SECTION_18: T-shape2 EQ.SECTION_08: Circular        EQ.SECTION_19: Box-shape1 EQ.SECTION_09: Tubular        EQ.SECTION_20: Hexagon EQ.SECTION_10: I-shape1        EQ.SECTION_21: Hat-shape EQ.SECTION_11: Solid box       EQ.SECTION_22: Hat-shape1
D1-D6	Input parameters for section option using STYPE above.
VOL	Volume of discrete beam and scalar (mat_146) beam. Used in calculating mass. If VOL=0 for cable elements, volume is calculated as the product of cable length and cable area. If the mass density of the material model for the discrete beam is set to unity, the magnitude of the lumped mass can be defined here instead. This lumped mass is partitioned to the two nodes of the beam element. The translational time step size for the type 6 beam is dependent on the volume, mass density, and the translational stiffness values, so it is important to define this parameter. Defining the volume is also essential for mass scaling if the type 6 beam controls the time step size.
INER	Mass moment of inertia for the six degree of freedom discrete beam and scalar (mat_146) beam. This parameter does not apply to cable elements. This lumped inertia is partitioned to the two nodes of the beam element. The rotational time step size for the type 6 beam is dependent on the lumped inertia and the rotational stiffness values, so it is important to define this parameter if the rotational springs are active. Defining the rotational inertia is also essential for mass scaling if the type 6 beam rotational stiffness controls the time step size.

<b>VARIABLE</b>	<b>DESCRIPTION</b>
CID	Coordinate system ID for orientation (material types 66-69, 93, 95, 97), see *DEFINE_COORDINATE_option. If CID=0, a default coordinate system is defined in the global system or on the third node of the beam, which is used for orientation. This option is not defined for material types that act between two nodal points, such as cable elements. The coordinate system rotates with the discrete beam, see SCOR above.
CA	Cable area. See material type 71, *MAT_CABLE_DISCRETE_BEAM.
OFFSET	Optional offset for cable. See material type 71, *MAT_CABLE_DISCRETE_BEAM.
RRCON	r-rotational constraint for local coordinate system (see Remark 8) EQ.0.0: Coordinate ID rotates about r axis with nodes. EQ.1.0: Rotation is constrained about the r-axis
SRCON	s-rotational constraint for local coordinate system (see Remark 8) EQ.0.0: Coordinate ID rotates about s axis with nodes. EQ.1.0: Rotation is constrained about the s-axis
TRCON	t-rotational constraint for local coordinate system (see Remark 8) EQ.0.0: Coordinate ID rotates about t axis with nodes. EQ.1.0: Rotation is constrained about the t-axis
CID	Coordinate system ID for orientation, material type 146, see *DEFINE_COORDINATE_SYSTEM. If CID=0, a default coordinate system is defined in the global system.
DOFN1	Active degree-of-freedom at node 1, a number between 1 and 6 where 1 in x-translation and 4 is x-rotation.
DOFN2	Active degree-of-freedom at node 2, a number between 1 and 6.
PRINT	Output spot force resultant from spotwelds. EQ.0.0: Data is output to SWFORC file. EQ.1.0: Output is suppressed.

**Remarks:**

1. For implicit calculations all of the beam element choices are implemented:
2. For the truss element, define the cross-sectional area, A, only.
3. The local coordinate system rotates as the nodal points that define the beam rotate. In some cases this may lead to unexpected results if the nodes undergo significant rotational

motions. In the definition of the local coordinate system using \*DEFINE\_COORDINATE\_NODES, if the option to update the system each cycle is active then this updated system is used. This latter technique seems to be more stable in some applications.

4. The integrated warped beam (type 11) is a 7 degree of freedom beam that must be used with an integration rule of the open standard cross sections, see \*INTEGRATION\_BEAM. To incorporate the additional degrees of freedom corresponding to the twist rates, the user should declare one scalar node (\*NODE\_SCALAR) for each node attached to a warped beam. This degree of freedom is associated to the beam element using the warpage option on the \*ELEMENT\_BEAM card.
5. Beam offsets are sometimes necessary for correctly modeling beams that act compositely with other elements such as shells or other beams. A beam offset extends from the beam's N1-to-N2 axis to the reference axis of the beam. The beam reference axis lies at the origin of the local s and t axes, i.e., halfway between the outermost surfaces of the beam cross-section. Note that for cross-sections that are not doubly symmetric, e.g, a T-section, the reference axis does not pass through the centroid of the cross-section. The offset in the positive s-direction is  $s\text{-offset} = -0.5 * NSLOC * (\text{beam cross-section dimension in s-direction})$ . Similarly, the offset in the positive t-direction is  $t\text{-offset} = -0.5 * NTLOC * (\text{beam cross-section dimension in t-direction})$ . If IRID is used to point to an integration rule with ICST>0, then offsets must be defined using SREF and TREF on the \*INTEGRATION\_BEAM card as they will override NSLOC and NTLOC even if SREF=0 or TREF=0. See also \*ELEMENT\_BEAM\_OFFSET for an alternate approach to defining beam offsets.
6. Element type 13 is a 3-D Timoshenko resultant-based beam element with two nodes for small displacement, linear isotropic elasticity. The stiffness matrix was derived by Yunhua Luo (Luo, 2008) using consistent cubic shape functions. This element only works with \*MAT\_ELASTIC. It uses the reference geometry to calculate the element stiffness and calculates the element forces by multiplying the element stiffness by the displacements. Offsets work but they are fixed for all time like the reference geometry.
7. If the magnitude of SCOOD is less than or equal to unity then zero length discrete beams are assumed with infinitesimal separation between the nodes in the deformed state. For large separations or nonzero length beams set |SCOOD| to 2 or 3, in which case true beam-like behavior is invoked to provide equilibrating torques to offset any force couples that arise due to translational stiffness or translational damping.
8. RRCON, SRCON, and TRCON are optional and apply only to non-cable discrete beams. If set to 1, RRCON, SRCON, and TRCON will prevent nodal rotations about the local r,s,t axes, respectively, from affecting the update of the local coordinate system. These three parameters have no influence on how nodal translations may affect the local coordinate system update.

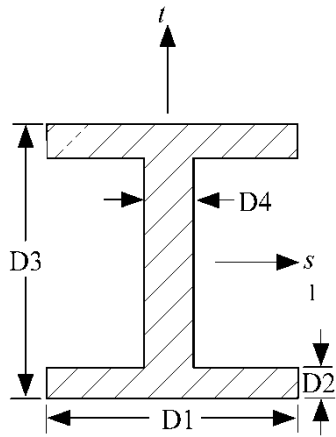


9. If CID is nonzero for a discrete beam and the coordinate system identified by CID uses \*DEFINE\_COORDINATE\_NODES with FLAG=1, the beam local system is updated based on the current orientation of the three nodes identified in \*DEFINE\_COORDINATE\_NODES. In this case, local coordinate system updates per SCOR types -3.0, -1.0, 0.0, 1.0, and 3.0 are inactive while for SCOR types -2 and 2, a final adjustment is made to the local coordinate system so that the local r-axis lies along the node1-to-node2 axis of the beam. An optional output database (\*DATABASE\_DISBOUT) will report relative displacements, rotations, and force resultants of discrete beams, all in the local coordinate system.

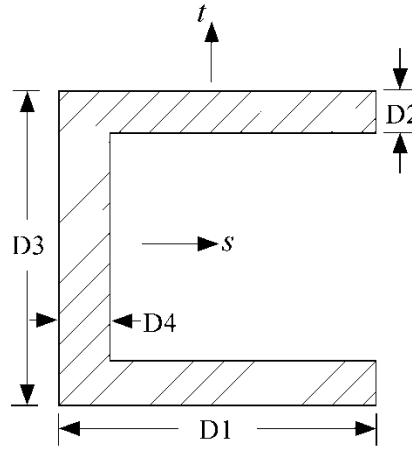
```

$$$$$$$$$$$$$$$$$$$$$$$$$$$$$$$$$$$$$$$$$$$$$$$$$$$$$$$$$$$$$$$$$$$$$$$$$$$$$$$$$$$$
$
$$$  *SECTION_BEAM
$
$$$$$$$$$$$$$$$$$$$$$$$$$$$$$$$$$$$$$$$$$$$$$$$$$$$$$$$$$$$$$$$$$$$$$$$$$$$$$$$$$$$$
$
$ Define a Belytschko-Schwer resultant beam (elform = 2) with the following
$ properties. This beam models the connection/stiffening beams of a medium
$ size roadside sign.
$
$   cross sectional area:                a =      515.6 mm2
$   2nd moment of area about s-axis:     iss = 99,660.0 mm4
$   2nd moment of area about t-axis:     itt = 70,500.0 mm4
$   2nd polar moment of area about beam axis:  j = 170,000.0 mm4
$
*SECTION_BEAM
$
$...>...1...>...2...>...3...>...4...>...5...>...6...>...7...>...8
$   sid   elform   shrf   qr/irid   cst
$       111       2
$
$       a       iss       itt       j       sa
$       515.6   99660.0   70500.0 170000.0
$
*SECTION_BEAM_TITLE
Main beam member
$
$...>...1...>...2...>...3...>...4...>...5...>...6...>...7...>...8
$   sid   elform   shrf   qr/irid   cst
$       111       2
$
$       a       iss       itt       j       sa
$       515.6   99660.0   70500.0 170000.0
$
$$$$$$$$$$$$$$$$$$$$$$$$$$$$$$$$$$$$$$$$$$$$$$$$$$$$$$$$$$$$$$$$$$$$$$$$$$$$$$$$$$$$

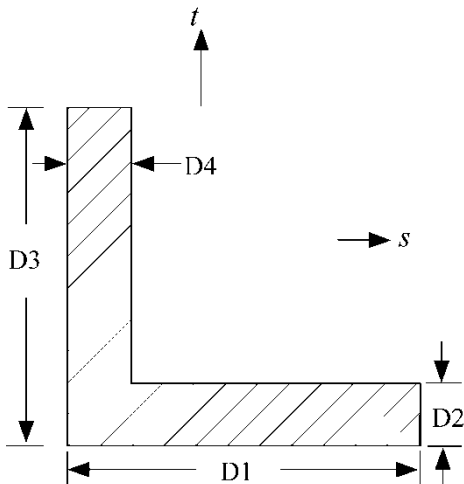
```



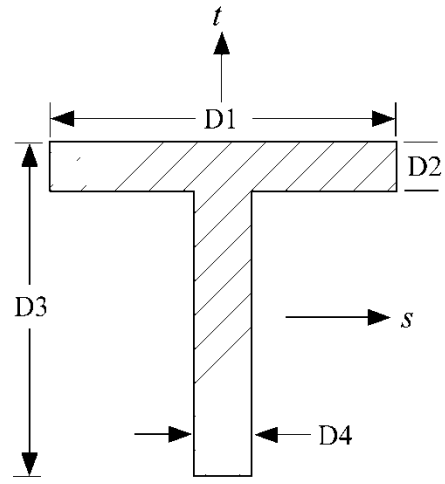
SECTION\_01: I-shape



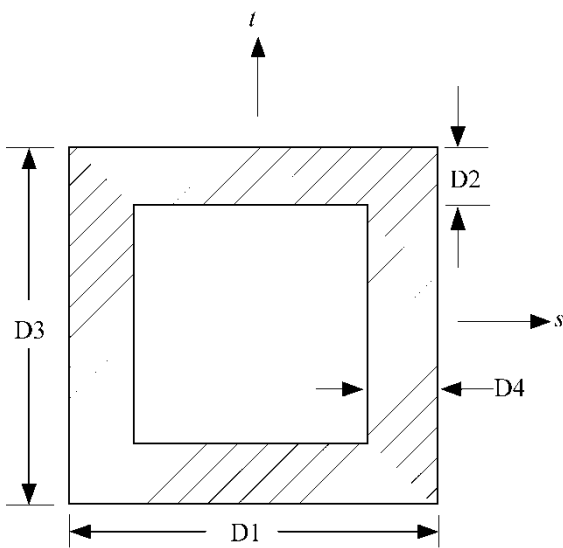
SECTION\_02: Channel



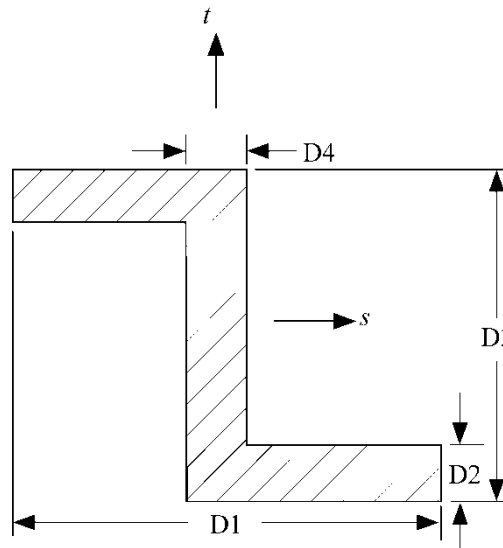
SECTION\_03: L-shape



SECTION\_04: T-shape



SECTION\_05: Box-shape



SECTION\_06: Z-shape

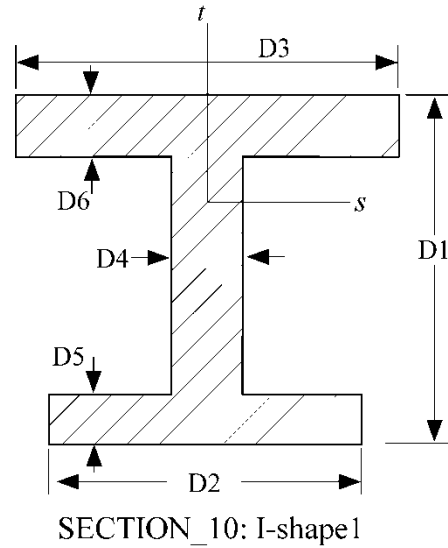
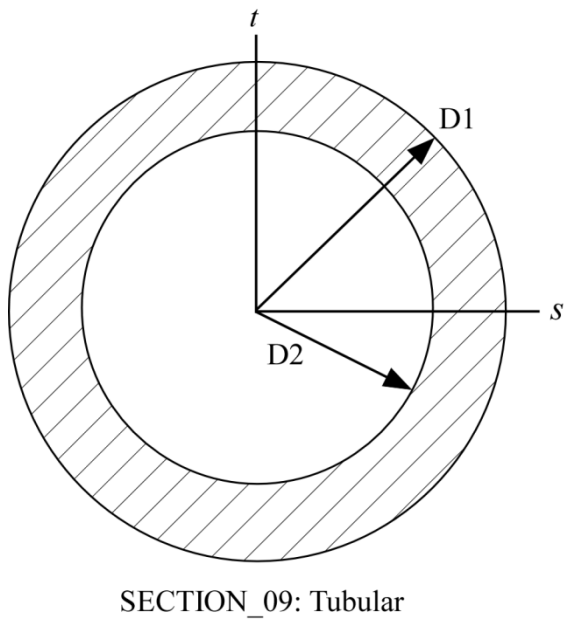
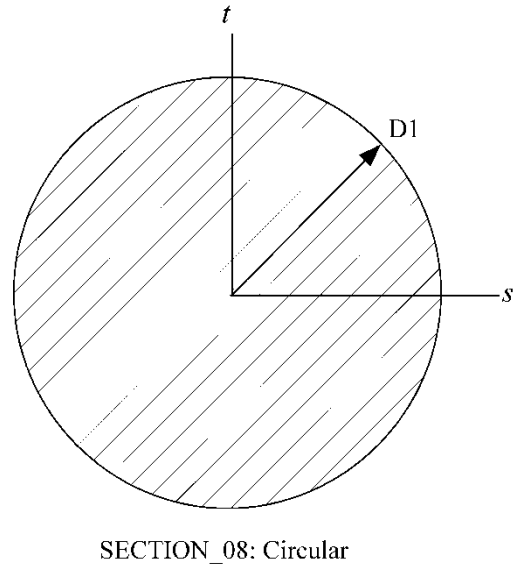
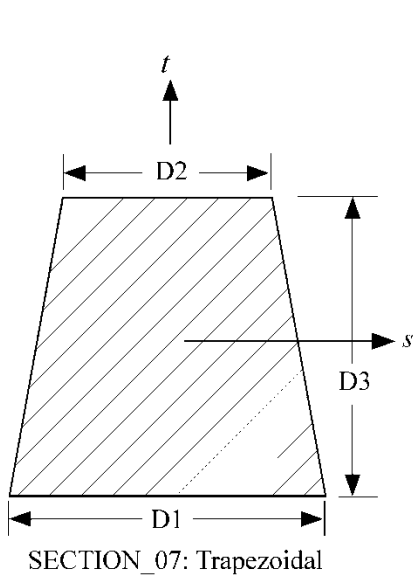


Figure 32.1. Properties of beam cross section for several common cross sections (cont'd).

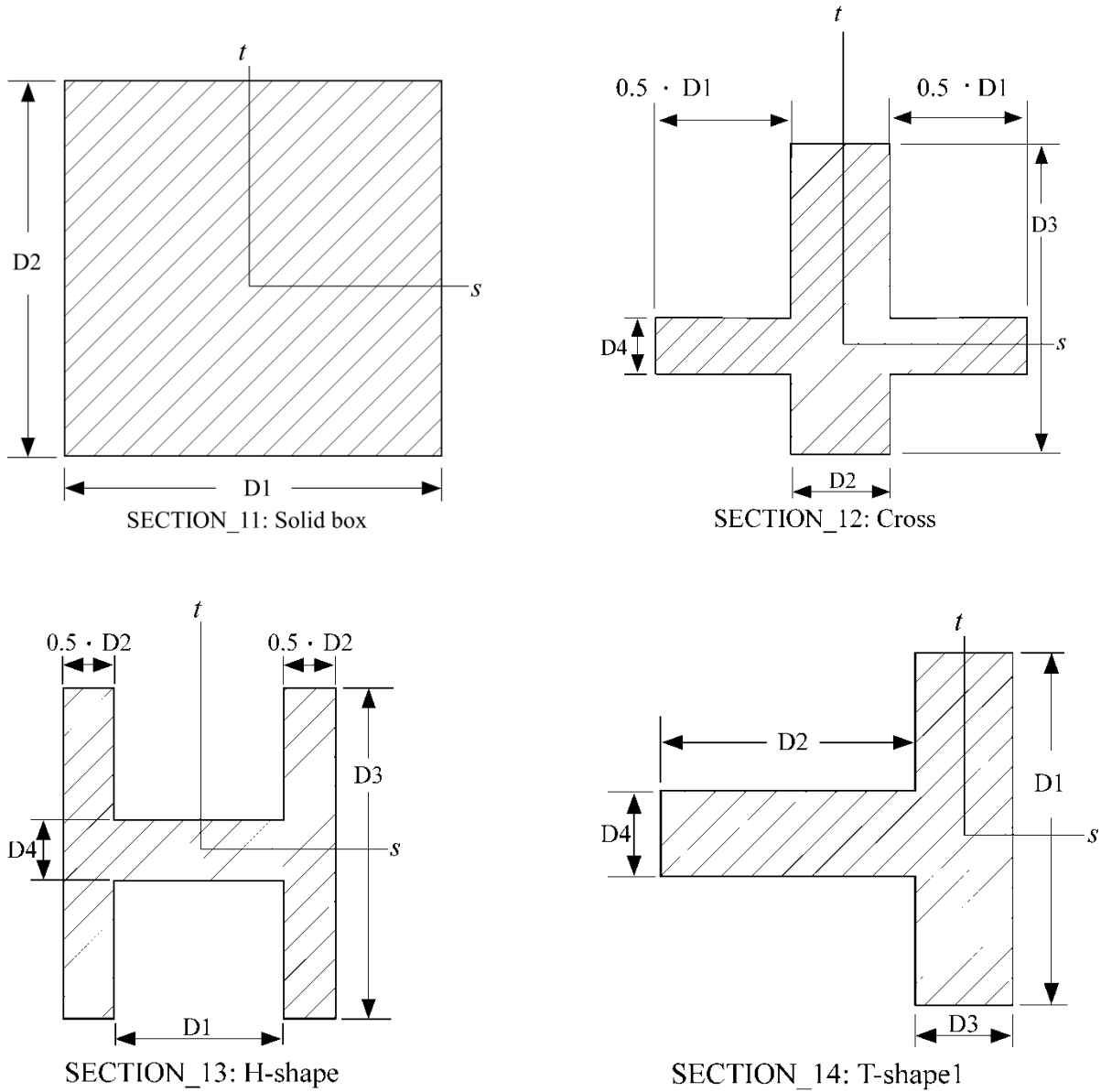


Figure 32.1. Properties of beam cross section for several common cross sections (cont'd).

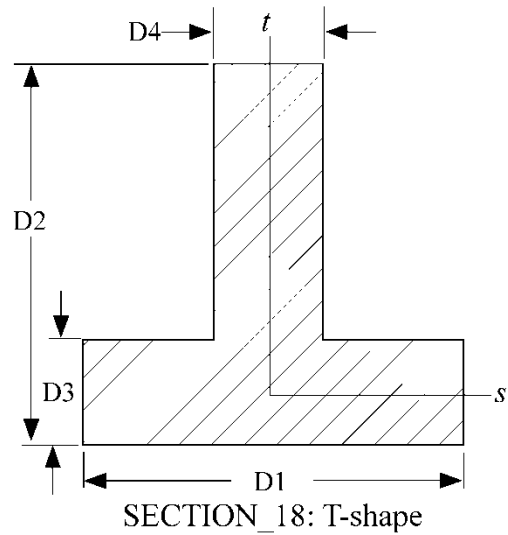
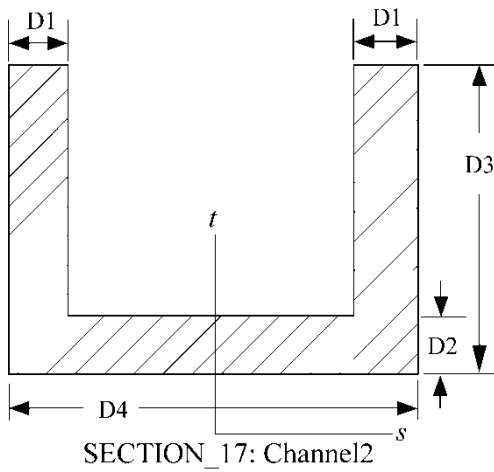
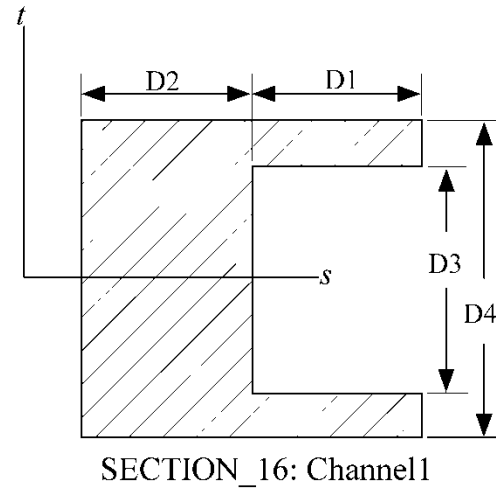
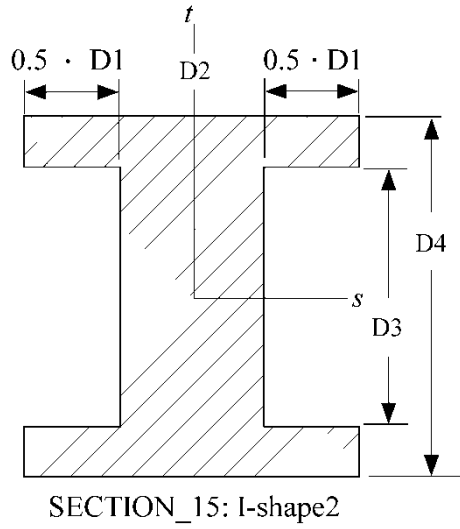
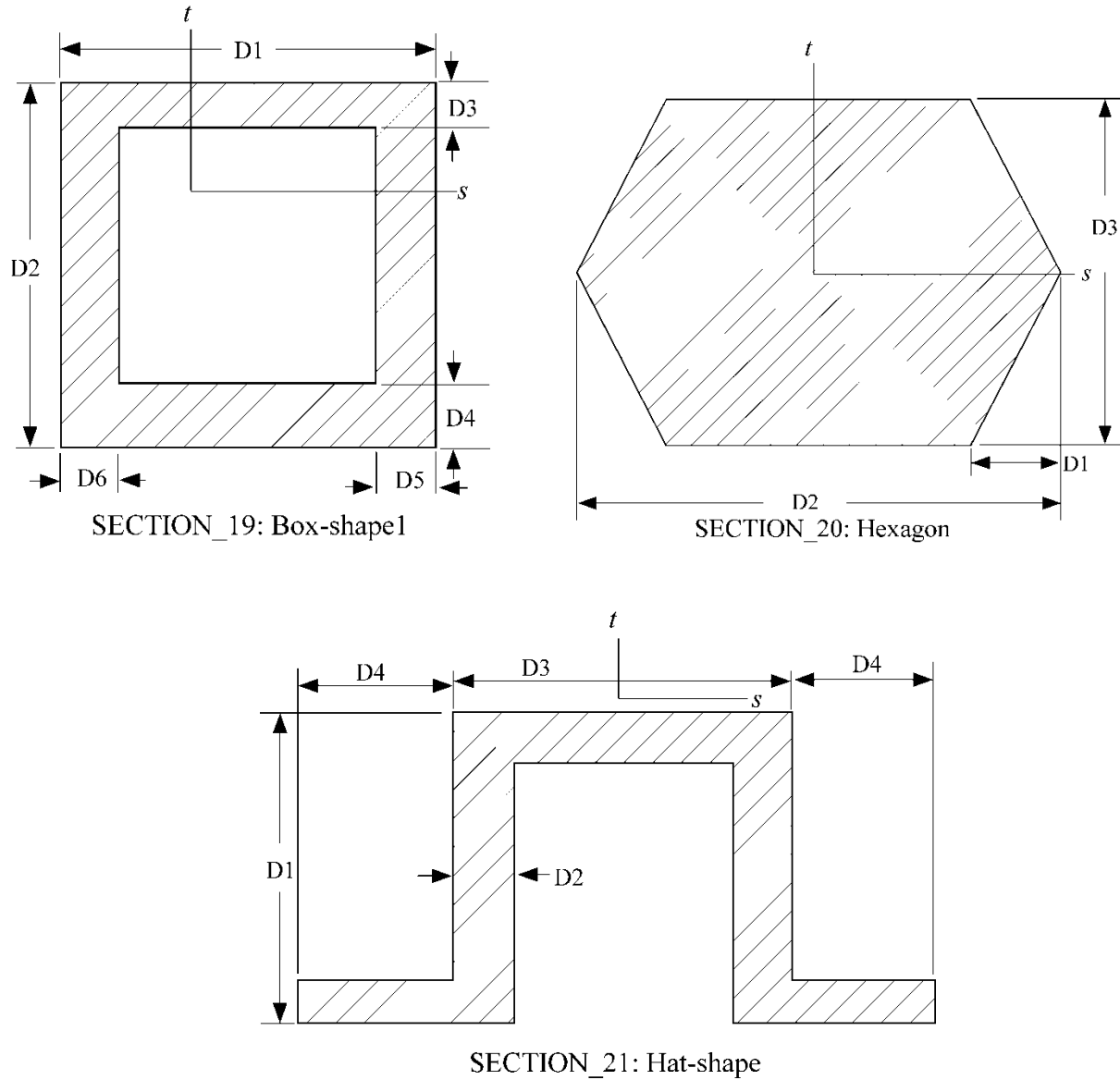
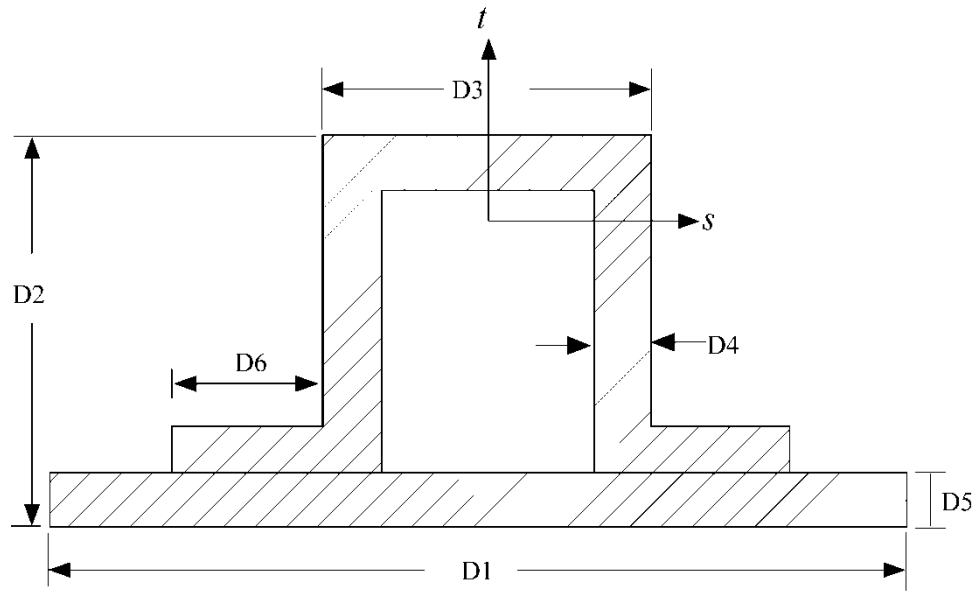


Figure 32.1. Properties of beam cross section for several common cross sections (cont'd).



**Figure 32.1.** Properties of beam cross section for several common cross sections (cont'd).



SECTION\_22: Hat-shape 1

Figure 32.1. Properties of beam cross section for several common cross sections (cont'd).





---

<u>VARIABLE</u>	<u>DESCRIPTION</u>
LFAC	Length scale factor to convert dimensions from standard units
NSLOC	Location of reference surface (see *SECTION_BEAM)
NTLOC	Location of reference surface (see *SECTION_BEAM)
K	Integration refinement parameter (see *INTEGRATION_BEAM)
RAMPT	Optional ramp-up time (see *SECTION_BEAM)
STRESS	Optional initial stress (see *SECTION_BEAM)

**Remarks:**

This keyword uses the dimensions of the standard AISC beams sections — as defined by the section label — to define \*SECTION\_BEAM and \*INTEGRATION\_BEAM cards with the appropriate parameters.

The AISC section label may be specified either as the shape designation as seen in the AISC Steel Construction Manual, 2005, or the designation according to the AISC Naming Convention for Structural Steel Products for Use in Electronic Data Interchange (EDI), 2001. As per the EDI convention, the section labels are to be case-sensitive and space sensitive, i.e. “W36X150” is acceptable but “W36 x 150” is not. Labels can be specified in terms of either the U.S. Customary units (in) or metric units (mm), which will determine the length units for the section dimensions. The parameter LFAC may be used as a multiplier to convert the dimensions to other lengths units.

# \*SECTION

\*SECTION\_DISCRETE

## \*SECTION\_DISCRETE

Purpose: Defined spring and damper elements for translation and rotation. These definitions must correspond with the material type selection for the elements, i.e., \*MAT\_SPRING\_... and \*MAT\_DAMPER\_...

Card 1            1            2            3            4            5            6            7            8

Variable	SECID	DRO	KD	V0	CL	FD		
Type	A8	I	F	F	F	F		

Card 2            1            2            3            4            5            6            7            8

Variable	CDL	TDL						
Type	F	F						

### VARIABLE

### DESCRIPTION

SECID	Section ID. SECID is referenced on the *PART card. A unique number or label not exceeding 8 characters must be specified.
DRO	Displacement/Rotation Option: EQ.0: the material describes a translational spring/damper, EQ.1: the material describes a torsional spring/damper.
KD	Dynamic magnification factor. See Remarks 1 and 2 below.
V0	Test velocity
CL	Clearance. See Remark 3 below.
FD	Failure deflection (twist for DRO=1). Negative for compression, positive for tension.
CDL	Deflection (twist for DRO=1) limit in compression. See Remark 4 below.
TDL	Deflection (twist for DRO=1) limit in tension. See Remark 4 below.

**Remarks:**

- 1. The constants from KD to TDL are optional and do not need to be defined.
- 2. If  $k_d$  is nonzero, the forces computed from the spring elements are assumed to be the static values and are scaled by an amplification factor to obtain the dynamic value:

$$F_{dynamic} = \left( 1. + k_d \frac{V}{V_0} \right) F_{static}$$

where

$V$  = absolute value of the relative velocity between the nodes.

$V_0$  = dynamic test velocity.

For example, if it is known that a component shows a dynamic crush force at 15m/s equal to 2.5 times the static crush force, use  $k_d=1.5$  and  $V_0=15$ .

- 3. Here, “clearance” defines a compressive displacement which the spring sustains before beginning the force-displacement relation given by the load curve defined in the material selection. If a non-zero clearance is defined, the spring is compressive only.
- 4. The deflection limit in compression and tension is restricted in its application to no more than one spring per node subject to this limit, and to deformable bodies only. For example in the former case, if three springs are in series, either the center spring or the two end springs may be subject to a limit, but not all three. When the limiting deflection is reached, momentum conservation calculations are performed and a common acceleration is computed in the appropriate direction. An error termination will occur if a rigid body node is used in a spring definition where deflection is limited.

Constrained boundary conditions on the \*NODE cards and the BOUNDARY\_SPC cards must not be used for nodes of springs with deflection limits.

- 5. Discrete elements can be included in implicit applications.

```

$$$$$$$$$$$$$$$$$$$$$$$$$$$$$$$$$$$$$$$$$$$$$$$$$$$$$$$$$$$$$$$$$$$$$$$$$$$$$$$$
$
$$$$ *SECTION_DISCRETE
$
$$$$$$$$$$$$$$$$$$$$$$$$$$$$$$$$$$$$$$$$$$$$$$$$$$$$$$$$$$$$$$$$$$$$$$$$$$$$$$$$
$
$ Note: These examples are in kg, mm, ms, kN units.
$
$ A translational spring (dro = 0) is defined to have a failure deflection
$ of 25.4 mm (fd = 25.4). The spring has no dynamic effects or
$ deflection limits, thus, those parameters are not set.
$

```

**\*SECTION**

**\*SECTION\_DISCRETE**

```
*SECTION_DISCRETE
$
$.>...1.>...2.>...3.>...4.>...5.>...6.>...7.>...8
$   sid     dro     kd     v0     c1     fd
   104      0             25.4
$
$   cdl     tdl
$
$
$ Define a translational spring that is known to have a dynamic crush force
$ equal to 2.5 times the static force at a 15 mm/ms deflection rate.
$ Additionally, the spring is known to be physically constrained to deflect
$ a maximum of 12.5 mm in both tension and compression.
$
*SECTION_DISCRETE
$.>...1.>...2.>...3.>...4.>...5.>...6.>...7.>...8
$   sid     dro     kd     v0     c1     fd
   107      0     1.5    15.0
$
$   cdl     tdl
   12.5     12.5
$
$$$$$$$$$$$$$$$$$$$$$$$$$$$$$$$$$$$$$$$$$$$$$$$$$$$$$$$$$$$$$$$$$$$$$$$$$$$$$$$$$$$$
```

**\*SECTION\_POINT\_SOURCE**

Purpose: This command provides the inlet boundary condition for single gas in flow (inflation potential) via a set of point source(s). It also provides the inflator orifice geometry information. It requires 3 curves defining the inlet condition for the inflator gas coming into the tank or an airbag as input ( $\bar{T}_{\text{gas\_corrected}}(t)$ ,  $v_r(t)$ , and  $vel(t)$ ). Please see also the \*ALE\_TANK\_TEST card for additional information.

Card 1            1            2            3            4            5            6            7            8

Variable	SECID	LCIDT	LCIDVOLR	LCIDVEL	NIDLC001	NIDLC002	NIDLC003	
Type	A8	I	I	I	I	I	I	
Default	0	0	0	0	0	0	0	

Card 2            1            2            3            4            5            6            7            8

Variable	NODEID	VECID	ORIFAREA					
Type	I	I	F					
Default	0	0	0.0					

<u>VARIABLE</u>	<u>DESCRIPTION</u>
SECID	Section ID. A unique number or label not exceeding 8 characters must be specified.
LCIDT	Temperature load curve ID
LCIDVOLR	Relative volume load curve ID
LCIDVEL	Inlet flow velocity load curve ID
NIDLC001	The 1 <sup>st</sup> node ID defining a local coordinate (See Remark 2).
NIDLC002	The 2 <sup>nd</sup> node ID defining a local coordinate (See Remark 2).

<u>VARIABLE</u>	<u>DESCRIPTION</u>
NIDLCOO3	The 3 <sup>rd</sup> node ID defining a local coordinate (See Remark 2).
NODEID	The node ID(s) defining the point source(s).
VECID	The vector ID defining the direction of flow at each point source.
ORIFAREA	The orifice area at each point source.

**Remarks:**

1. In an airbag inflator tank test, the tank pressure data is measured. This pressure is used to derive  $\dot{m}(t)$  and the estimated  $\bar{T}_{gas}(t)$ , usually via a lumped-parameter method, a system of conservation equations and EOS. Subsequently  $\dot{m}(t)$  and  $\bar{T}_{gas}(t)$  (stagnation temperature) are used as input to obtain  $\bar{T}_{gas\_corrected}(t)$  (static temperature),  $v_r(t)$ , and  $vel(t)$ . These 3 curves are then used to describe inflator gas inlet condition (see \*ALE\_TANK\_TEST for more information).
2. In a car crash model, the inflator housing may get displaced during the impact. The 3 node IDs defines the local reference coordinate system to which the point sources are attached. These 3 reference nodes may be located on a rigid body which can translate and rotate as the inflator moves during the impact. This allows for the point sources to move in time. These reference nodes may be used as the point sources themselves.
3. If the \*ALE\_TANK\_TEST card is present, please see the Remarks under that card.

**Example:**

Consider a tank test model which consists of the inflator gas (PID 1) and the air inside the tank (PID 2). The 3 load curves define the thermodynamic and kinetic condition of the incoming gas. The nodes define the center of the orifice, and the vector the direction of flow at each orifice.

```

$. . . | . . . 1 . . . | . . . 2 . . . | . . . 3 . . . | . . . 4 . . . | . . . 5 . . . | . . . 6 . . . | . . . 7 . . . | . . . 8
*PART
inflator gas
$      PID      SECID      MID      EOSID      HGID      GRAV      ADPOPT      TMID
      1          1          1          0          0          0          0          0
*SECTION_POINT_SOURCE
$      SECID      LCIDT      LCIDVOLR      LCIDVEL      NIDLCOOR1      NIDLCOOR2      NIDLCOOR3
      1          3          4          5          0          0          0
$      NODEID      VECTID      AREA
      24485          3      15.066
      . . .
      24557          3      15.066

```

**\*SECTION\_POINT\_SOURCE**

**\*SECTION**

```
*PART
air inside the tank
$      PID      SECID      MID      EOSID      HGID      GRAV      ADPOPT      TMID
      2          2          2          0          0          0          0          0
*SECTION_SOLID
$      SECID      ELFORM      AET
      2          11          0
*ALE_MULTI-MATERIAL_GROUP
$      SID      SIDTYPE
      1          1
      2          1
$...|...1...|...2...|...3...|...4...|...5...|...6...|...7...|...8
```

# \*SECTION

# \*SECTION\_POINT\_SOURCE\_MIXTURE

## \*SECTION\_POINT\_SOURCE\_MIXTURE

Purpose: This command provides (a) an element formulation for a solid ALE part of the type similar to ELFORM=11 of \*SECTION\_SOLID, and (b) the inlet gas injection boundary condition for multiple-gas mixture in-flow via a set of point source(s). It also provides the inflator orifice geometry information. This must be used in combination with the \*MAT\_GAS\_MIXTURE and/or \*INITIAL\_GAS\_MIXTURE card (see Remark 1).

Card 1            1            2            3            4            5            6            7            8

Variable	SECID	LCIDT	Not Used	LCIDVEL	NIDLC001	NIDLC002	NIDLC003	IDIR
Type	A8	I		I	I	I	I	I
Default	none	none		none	none	none	none	0

Card 2            1            2            3            4            5            6            7            8

Variable	LCMDOT1	LCMDOT2	LCMDOT3	LCMDOT4	LCMDOT5	LCMDOT6	LCMDOT7	LCMDOT8
Type	I	I	I	I	I	I	I	I
Default	none	none	none	none	none	none	none	none

Card 3            1            2            3            4            5            6            7            8

Variable	NODEID	VECID	ORIFAREA					
Type	I	I	F					
Default	none	none	0.0					



<u>VARIABLE</u>	<u>DESCRIPTION</u>
SECID	Section ID. A unique number or label not exceeding 8 characters must be specified.
LCIDT	Inflator gas mixture average stagnation temperature load curve ID (all gases of the mixture are assumed to have the same average temperature).
LCIDVEL	User-defined inflator gas mixture average velocity load curve ID. If LCIDVEL=0 or blank, LSDYNA will estimate the inlet gas velocity.
NIDLC001	The 1 <sup>st</sup> node ID defining a local coordinate (see Remark 2).
NIDLC002	The 2 <sup>nd</sup> node ID defining a local coordinate (see Remark 2).
NIDLC003	The 3 <sup>rd</sup> node ID defining a local coordinate (see Remark 2).
IDIR	A flag for constraining the nodal velocity of the nodes of the ALE element containing a point source. If IDIR=0 (default), then the ALE nodes behind the point source (relative position of nodes based on the vector direction of flow of point source) will have zero velocity. If IDIR=1, then all ALE nodes will have velocity distributed based on energy conservation. The latter option seems to be more robust in airbag modeling (see Remark 6).
LCMDOT1	The mass flow rate load curve ID of the 1 <sup>st</sup> gas in the mixture.
LCMDOTn	The mass flow rate load curve ID of the n <sup>th</sup> gas in the mixture.
LCMDOT8	The mass flow rate load curve ID of the 8 <sup>th</sup> gas in the mixture.
NODEID	The node ID(s) defining the point sources (see Remark 6).
VECID	The vector ID defining the direction of flow at each point source.
ORIFAREA	The orifice area at each point source.

**Remarks:**

1. This command is used to define a part that acts as the ideal gas mixture injection source. The associated ALE material (gas mixture) may not be present at time zero, but can be introduced (injected) into an existing ALE domain. For airbag application, the input from control volume analysis, inlet mass flow rate,  $\dot{m}(t)$ , and, inlet stagnation gas temperature,  $\bar{T}_{\text{gas}}(t)$  may be used as direct input for ALE analysis. If available, the user

may input a load curve for the gas mixture average inlet velocity. If not, LS-DYNA will estimate the inlet gas velocity.

2. The gas mixture is assumed to have a uniform temperature ( $\bar{T} \approx T_i$ ) and inlet velocity. However, the species in the mixture may each have a different inlet mass flow rate.
3. A brief review of the concept used is presented. The total energy ( $e_T$ ) is the sum of internal ( $e_i$ ) and kinetic  $\left(\frac{V^2}{2}\right)$  energies, (per unit mass).

$$e_T = e_i + \frac{V^2}{2}$$

$$C_V T_{\text{stag}} = C_V T + \frac{V^2}{2}$$

$$T_{\text{stag}} = T + \frac{V^2}{2C_V}$$

The distinction between stagnation and static temperatures is shown above.  $C_V$  is the constant-volume heat capacity. The gas mixture average internal energy per unit mass in terms of mixture species contribution is

$$e_i = \bar{C}_V \bar{T} = \sum_i \left( \frac{\rho_i}{\rho_{\text{mixture}}} \right) C_{V_i} T_i = \left[ \sum_i \left( \frac{\rho_i}{\rho_{\text{mixture}}} \right) C_{V_i} \right] \bar{T}$$

$$\bar{C}_V = \left[ \sum_i \left( \frac{\rho_i}{\rho_{\text{mixture}}} \right) C_{V_i} \right]$$

Since we approximate  $\bar{T} \approx T_i$ , then gas mixture average static temperature is related to the mixture average internal energy per unit mass as following

$$\bar{T} = \frac{e_i}{\left[ \sum_i \left( \frac{\rho_i}{\rho_{\text{mixture}}} \right) C_{V_i} \right]}$$

Note that the “i” subscript under “e” denotes “internal” energy, while the other “i” subscripts denote the “i<sup>th</sup>” species in the gas mixture. The total mixture pressure is the sum of the partial pressures of the individual species.

$$\bar{p} = \sum_i p_i$$

The ideal gas EOS applies to each individual species (by default)

$$P_i = \rho_i (C_{P_i} - C_{V_i}) T_i$$

4. Generally, it is not possible to conserve both momentum and kinetic (KE) at the same time. Typically, internal energy (IE) is conserved and KE may not be. This may result in some KE loss (hence, total energy loss). For many analyses this is tolerable, but for airbag application, this may lead to the reduction of the inflating potential of the inflator gas.

In \*MAT\_GAS\_MIXTURE computation, any kinetic energy not accounted-for during advection is stored in the internal energy. Therefore, there is no kinetic energy loss, and the total energy of the element is conserved over the advection step. This is a simple, ad hoc approach that is not rigorously derived for the whole system based on first principles. Therefore it is not guaranteed to apply universally to all scenarios. It is the user's responsibility to validate the model with data.

5. Since ideal gas is assumed, there is no need to define the EOS for the gases in the mixture.
6. In general, it is best to locate a point source near the center of an ALE element. Associated with each point source is an area and a vector indicating flow direction. Each point source should occupy 1 ALE element by itself, and there should be at least 2 empty ALE elements between any 2 point sources. A point source should be located at least 3 elements away from the free surface of an ALE mesh for stability.

### **Example 1:**

Consider a tank test model without coupling which consists of:

- a background mesh with air (PID 1 = gas 1) initially inside that mesh (tank space), and
- the inflator gas mixture (PID 2 consisting of inflator gases 2, 3, and 4).

The mixture is represented by one AMMGID and the air by another AMMGID.

The tank internal space is simply modeled with an Eulerian mesh of the same volume. The Tank itself is not modeled thus no coupling is required. The inflator gases fill up this space mixing with the air initially inside the tank.

The background air (gas 1) is included in the gas mixture definition in this case because that air will participate in the mixing process. Only include in the mixture those gases that actually undergo mixing (gases 1, 2, 3 and 4). Note that for an airbag model, the "outside" air should not be included in the mixture (it should be defined independently) since it does not participate in the mixing inside the airbag. This is shown in the next example.

## \*SECTION

## \*SECTION\_POINT\_SOURCE\_MIXTURE

The nodes define the center of the orifices, and the vectors define the directions of flow at these orifices.

```
$. . . | . . . . 1 . . . . | . . . . 2 . . . . | . . . . 3 . . . . | . . . . 4 . . . . | . . . . 5 . . . . | . . . . 6 . . . . | . . . . 7 . . . . | . . . . 8
*PART
Tank background mesh, initially filled with air, allows gas mixture to flow in.
$   PID      SECID      MID      EOSID      HGID      GRAV      ADPOPT      TMID
   1         1         1         0         0         0         0         0
*SECTION_SOLID
$   SECID      ELFORM      AET
   1         11         0
$ The next card defines the properties of the gas species in the mixture.
*MAT_GAS_MIXTURE
$   MID
   1
$   Cv1      Cv2      Cv3      Cv4      Cv5      Cv6      Cv7      Cv8
  654.47    482.00    2038.30    774.64     0.0     0.0     0.0     0.0
$   Cp1      Cp2      Cp3      Cp4      Cp5      Cp6      Cp7      Cp8
  941.32    666.67    2500.00   1071.40     0.0     0.0     0.0     0.0

$ The next card specifies that gas 1 (background air) occupies PID 1 at time 0.
*INITIAL_GAS_MIXTURE
$   SID      STYPE      AMMGID      TEMP0
   1         1         1         293.00
$   RHO1      RHO2      RHO3      RHO4      RHO5      RHO6      RHO7      RHO8
  1.20E-9     0.0     0.0     0.0     0.0     0.0     0.0     0.0
*PART
The gas mixture (inlet) definition (no initial mesh required for this PID)
$   PID      SECID      MID      EOSID      HGID      GRAV      ADPOPT      TMID
   2         2         1         0         0         0         0         0
*SECTION_POINT_SOURCE_MIXTURE
$   SECID      LCIDT      NOTUSED      LCIDVEL      NIDLCOOR1      NIDLCOOR2      NIDLCOOR3      IDIR
   2         1         0         5         0         0         0         0
$   LCMDOT1      LCMDOT2      LCMDOT3      LCMDOT4      LCMDOT5      LCMDOT6      LCMDOT7      LCMDOT8
   0         2         3         4         0         0         0         0
$   NODEID      VECTID      AREA
  24485         1         25.0
   . . .
  24557         1         25.0
*ALE_MULTI-MATERIAL_GROUP
$   SID      SIDTYPE
   1         1
   2         1
*DEFINE_VECTOR
$   VECTID      XTAIL      YTAIL      ZTAIL      XHEAD      YHEAD      ZHEAD
   1         0.0     0.0     0.0     0.0     1.0     0.0
$. . . | . . . . 1 . . . . | . . . . 2 . . . . | . . . . 3 . . . . | . . . . 4 . . . . | . . . . 5 . . . . | . . . . 6 . . . . | . . . . 7 . . . . | . . . . 8
```

### Example 2:

Consider an airbag inflation model which consists of:

- a background Eulerian mesh for air initially outside the airbag (PID 1)
- the inflator gas mixture (PID 2 consisting of inflator gases 1, 2, and 3).

The mixture is represented by one AMMGID and the air by another AMMGID.

The background air (PID 1) is NOT included in the gas mixture definition in this case because that air will NOT participate in the mixing process. Only include in the mixture those gases that actually undergo mixing (gases 1, 2, and 3). Gases 1, 2, and 3 in this example correspond to gases 2, 3, and 4 in example 1. Compare the air properties in PID 1 here to that of example 1. Note that the \*INITIAL\_GAS\_MIXTURE card is not required to initialize the background mesh in this case.

```

$...|...1...|...2...|...3...|...4...|...5...|...6...|...7...|...8
*PART
Tank background mesh, initially filled with air, allows gas mixture to flow in.
$   PID      SECID      MID      EOSID      HGID      GRAV      ADPOPT      TMID
   1         1         1         0         0         0         0         0
*SECTION_SOLID
$   SECID     ELFORM      AET
   1         11         0
*MAT_NULL
$   MID      RHO      PCUT      MU      TEROD      CEROD      YM      PR
   1  1.20E-9  -1.0E-6    0.0    0.0      0.0      0.0    0.0
*EOS_IDEAL_GAS
$   EOSID     CV0      CP0      COEF1     COEF2      T0      RELVOL0
   1      654.47   941.32    0.0      0.0      293.00   1.0
$ The next card defines the properties of the gas species in the mixture.
*PART
The gas mixture (inlet) definition (no initial mesh required for this PID)
$   PID      SECID      MID      EOSID      HGID      GRAV      ADPOPT      TMID
   2         2         2         0         0         0         0         0
*SECTION_POINT_SOURCE_MIXTURE
$   SECID     LCIDT     NOTUSED   LCIDVEL  NIDLCOOR1  NIDLCOOR2  NIDLCOOR3   IDIR
   2         1         0         5         0         0         0         0
$   LCMDOT1   LCMDOT2   LCMDOT3   LCMDOT4   LCMDOT5   LCMDOT6   LCMDOT7   LCMDOT8
   2         3         4         0         0         0         0         0
$   NODEID    VECTID     AREA
   24485      1         25.0
   ...
   24557      1         25.0
*MAT_GAS_MIXTURE
$   MID
   2
$   Cv1      Cv2      Cv3      Cv4      Cv5      Cv6      Cv7      Cv8
   482.00    2038.30  774.64   0.0      0.0      0.0      0.0      0.0
$   Cp1      Cp2      Cp3      Cp4      Cp5      Cp6      Cp7      Cp8
   666.67    2500.00  1071.40  0.0      0.0      0.0      0.0      0.0
$ The next card specifies that gas 1 (background air) occupies PID 1 at time 0.
*ALE_MULTI-MATERIAL_GROUP
$   SID      SIDTYPE
   1         1
   2         1
*DEFINE_VECTOR
$   VECTID    XTAIL     YTAIL     ZTAIL     XHEAD     YHEAD     ZHEAD
   1         0.0      0.0      0.0      0.0      1.0      0.0
$...|...1...|...2...|...3...|...4...|...5...|...6...|...7...|...8

```

**\*SECTION**

**\*SECTION\_SEATBELT**

**\*SECTION\_SEATBELT**

Purpose: Define section properties for the seat belt elements. This card is required for the \*PART Section. Currently, only the ID is required.

Card 1                  1                  2                  3                  4                  5                  6                  7                  8

Variable	SECID	AREA	THICK					
Type	A8	F	F					

<u>VARIABLE</u>	<u>DESCRIPTION</u>
SECID	Section ID. A unique number or label not exceeding 8 characters must be specified.
AREA	Optional Area of cross-section used in contact
THICK	Optional Thickness used in contact

**Remarks:**

1. Seatbelt elements are implemented for both explicit and implicit calculations.

```

$$$$$$$$$$$$$$$$$$$$$$$$$$$$$$$$$$$$$$$$$$$$$$$$$$$$$$$$$$$$$$$$$$$$$$$$$$$$$$$$
$
$$$  *SECTION_SEATBELT
$
$$$$$$$$$$$$$$$$$$$$$$$$$$$$$$$$$$$$$$$$$$$$$$$$$$$$$$$$$$$$$$$$$$$$$$$$$$$$$$$$
$
$ Define a seat belt section that is referenced by part 10. Nothing
$ more than the sid is required.
$
*SECTION_SEATBELT
$
$.>...1.>...2.>...3.>...4.>...5.>...6.>...7.>...8
$   sid
     111
$
$
*PART
Seatbelt material
$.>...1.>...2.>...3.>...4.>...5.>...6.>...7.>...8
$   pid   sid   mid   eosid   hgid   adpopt
     10    111   220
$
$$$$$$$$$$$$$$$$$$$$$$$$$$$$$$$$$$$$$$$$$$$$$$$$$$$$$$$$$$$$$$$$$$$$$$$$$$$$$$$$

```

**\*SECTION\_SHELL\_{OPTION}**

Available options include:

**<BLANK>**

**EFG**

**THERMAL**

**XFEM**

such that the keyword cards appear:

**\*SECTION\_SHELL**

**\*SECTION\_SHELL\_EFG**

**\*SECTION\_SHELL\_THERMAL**

**\*SECTION\_SHELL\_XFEM**

Purpose: Define section properties for shell elements.

Card 1	1	2	3	4	5	6	7	8
--------	---	---	---	---	---	---	---	---

Variable	SECID	ELFORM	SHRF	NIP	PROPT	QR/IRID	ICOMP	SETYP
Type	A8	I	F	F	F	F	I	I
Default	none		1.0	2	0.0	0.0	0	1
Remarks		1,7,8						

Card 2            1            2            3            4            5            6            7            8

Variable	T1	T2	T3	T4	NLOC	MAREA	IDOF	EDGSET
Type	F	F	F	F	F	F	F	I
Default	0.0	T1	T1	T1	0.0	0.0	0.0	
Remarks							7	8

**Optional Section Cards if ICOMP=1. Define NIP angles putting 8 on each card.**

Card            1            2            3            4            5            6            7            8

Variable	B1	B2	B3	B4	B5	B6	B7	B8
Type	F	F	F	F	F	F	F	F

**Optional Section Card for EFG option.**

Also see \*CONTROL\_EFG.

Card            1            2            3            4            5            6            7            8

Variable	DX	DY	ISPLINE	IDILA				
Type	F	F	I	I				
Default	1.01	1.01	0	0				



**Optional Section Card for THERMAL option.**

Card            1            2            3            4            5            6            7            8

Variable	ITHELFM							
Type	I							
Default	0							

**Optional Section Card for XFEM option.**

Also see remark 9.

Card            1            2            3            4            5            6            7            8

Variable	CMID	BASELM	DOMINT	FAILCR	PROPCR	LPRINT		
Type	I	I	I	I	I	I		
Default			0	1		0		

**Define the next 3 cards if and only if ELFORM=101,102,103,104 or 105.**

Also see Appendix C

Card            1            2            3            4            5            6            7            8

Variable	NIPP	NXDOF	IUNF	IHGF	ITAJ	LMC	NHSV	ILOC
Type	I	I	I	I	I	I	I	I
Default	0	0	0	0	0	0	0	0

**Define NIPP cards according to the following format**

Also see Appendix C

Card            1            2            3            4            5            6            7            8

Variable	XI	ETA	WGT					
Type	F	F	F					
Default	None	None	None					

**Define LMC property parameters using 8 parameters per card.**

Also see Appendix C

Card            1            2            3            4            5            6            7            8

Variable	P1	P2	P3	P4	P5	P6	P7	P8
Type	F	F	F	F	F	F	F	F
Default	0	0	0	0	0	0	0	0

**VARIABLE****DESCRIPTION**

SECID

Section ID. SECID is referenced on the \*PART card. A unique number or label not exceeding 8 characters must be specified.

ELFORM

Element formulation options, see Remarks 1 and 2 below:

EQ.1: Hughes-Liu,

EQ.2: Belytschko-Tsay,

EQ.3: BCIZ triangular shell,

EQ.4: C<sup>0</sup> triangular shell,

EQ.5: Belytschko-Tsay membrane,

EQ.6: S/R Hughes-Liu,

EQ.7: S/R co-rotational Hughes-Liu,

EQ.8: Belytschko-Leviathan shell,

EQ.9: Fully integrated Belytschko-Tsay membrane,

EQ.10: Belytschko-Wong-Chiang,

EQ.11: Fast (co-rotational) Hughes-Liu,

EQ.12: Plane stress (x-y plane),

VARIABLE	DESCRIPTION
	EQ.13: Plane strain (x-y plane),
	EQ.14: Axisymmetric solid (y-axis of symmetry) - area weighted,
	EQ.15: Axisymmetric solid (y-axis of symmetry) - volume weighted,
	EQ.16: Fully integrated shell element (very fast),
	EQ.17: Fully integrated DKT, triangular shell element,
	EQ.18: Fully integrated linear DK quadrilateral/triangular shell
	EQ.20: Fully integrated linear assumed strain C <sup>0</sup> shell (See Remarks).
	EQ.21: Fully integrated linear assumed strain C <sup>0</sup> shell (5 DOF).
	EQ.22: Linear shear panel element (3 DOF per node, see remarks)
	EQ.23: 8-node quadratic quadrilateral shell
	EQ.24: 6-node quadratic triangular shell
	EQ.25: Belytschko-Tsay shell with thickness stretch.
	EQ.26: Fully integrated shell with thickness stretch.
	EQ.27: C <sup>0</sup> triangular shell with thickness stretch.
	EQ.41: Mesh-free shell local approach.
	EQ.42: Mesh-free shell global approach.
	EQ.43: Mesh-free plane strain formulation (x-y plane).
	EQ.44: Mesh-free axisymmetric solid formulation (y-axis of symmetry).
	EQ.46: Cohesive element for two-dimensional plane strain, plane stress, and area-weighted axisymmetric problems (type 14 shells).
	EQ.47: Cohesive element for two-dimensional volume-weighted axisymmetric problems (use with type 15 shells).
	EQ.52: Plane strain (x-y plane) XFEM, base element type 13.
	EQ.54: Shell XFEM, base element type defined by BASELM (default 16).
	EQ.98: Interpolation shell
	EQ.99: Simplified linear element for time-domain vibration studies. See Remark 4 below.
	GT.100.AND.LT.106: User defined shell
	EQ.201: Isogeometric shells with NURBS. See *ELEMENT_SHELL_NURBS_PATCH
	GE.1000: Generalized shell element formulation (user defined). See *DEFINE_ELEMENT_GENERALIZED_SHELL
	The type 18 element is only for linear static and normal modes. It can also be used for linear springback in sheet metal stamping. Note that the 2D and 3D element types must not be mixed, and different types of 2D elements must not be used together. For example, 2D axisymmetric calculations can use either element types 14 or 15 but these element types must not be mixed together. Likewise, the plane strain element type must not be used with either the plane stress element or the axisymmetric element types. In 3D, the different shell elements

**VARIABLE****DESCRIPTION**

---

	types, i.e., 1-11 and 16, can be freely mixed together.
SHRF	Shear correction factor which scales the transverse shear stress. The shell formulations in LS-DYNA, with the exception of the BCIZ and DK elements, are based on a first order shear deformation theory that yields constant transverse shear strains which violates the condition of zero traction on the top and bottom surfaces of the shell. The shear correction factor is attempt to compensate for this error. A suggested value is 5/6 for isotropic materials. This value is incorrect for sandwich or laminated shells; consequently, laminated/sandwich shell theory is now an option in some of the constitutive models, e.g., material types 22, 54, and 55.
NIP	<p>Number of through thickness integration points. Either Gauss (default) or Lobatto integration can be used. The flag for Lobatto integration can be set on the control card, *CONTROL_SHELL. The location of the Gauss and Lobatto integration points are tabulated below.</p> <ul style="list-style-type: none"><li>EQ.0.0: set to 2 integration points for shell elements.</li><li>EQ.1.0: 1 point (no bending)</li><li>EQ.2.0: 2 point</li><li>EQ.3.0: 3 point</li><li>EQ.4.0: 4 point</li><li>EQ.5.0: 5 point</li><li>EQ.6.0: 6 point</li><li>EQ.7.0: 7 point</li><li>EQ.8.0: 8 point</li><li>EQ.9.0: 9 point</li><li>EQ.10.: 10 point</li><li>GT.10.: trapezoidal or user defined rule</li></ul> <p>Through thickness integration for the two-dimensional elements (options 12-15 above) is not meaningful; consequently, the default is equal to 1 integration point. Fully integrated two-dimensional elements are available for options 13 and 15 by setting NIP equal to a value of 4 corresponding to a 2 by 2 Gaussian quadrature. If NIP is 0 or 1 and the *MAT_SIMPLIFIED_JOHNSON_COOK model is used, then a resultant plasticity formulation is activated. NIP is always set to 1 if a constitutive model based on resultants is used.</p>
PROPT	<p>Printout option (***NOT ACTIVE***):</p> <ul style="list-style-type: none"><li>EQ.1.0: average resultants and fiber lengths,</li><li>EQ.2.0: resultants at plan points and fiber lengths,</li><li>EQ.3.0: resultants, stresses at all points, fiber lengths.</li></ul>
QR/IRID	Quadrature rule or Integration rule ID, see *INTEGRATION_SHELL:

VARIABLE	DESCRIPTION
	LT.0.0: absolute value is specified rule number, EQ.0.0: Gauss/Lobatto (up to 10 points are permitted), EQ.1.0: trapezoidal, not recommend for accuracy reasons.
ICOMP	Flag for orthotropic/anisotropic layered composite material model. This option applies to material types 22, 23, 33, 34, 36, 40, 41-50, 54-56, 58, 59, 103, 116, and 194. EQ.1: a material angle in degrees is defined for each through thickness integration point. Thus, each layer has one integration point.
SETYP	Not used (obsolete).
T1	Shell thickness at node $n_1$ , unless the thickness is defined on the *ELEMENT_SHELL_OPTION card.
T2	Shell thickness at node $n_2$ , see comment for T1 above.
T3	Shell thickness at node $n_3$ , see comment for T1 above.
T4	Shell thickness at node $n_4$ , see comment for T1 above.
NLOC	Location of reference surface for three dimensional shell elements. If nonzero, the offset distance from the plane of the nodal points to the reference surface of the shell in the direction of the shell normal vector is a value $offset = -0.50 \times NLOC \times (average\ shell\ thickness)$ . This offset is not considered in the contact subroutines unless CNTCO is set to 1 in *CONTROL_SHELL. Alternatively, the offset can be specified by using the OFFSET option in the *ELEMENT_SHELL input section. EQ. 1.0: top surface, EQ. 0.0: mid-surface (default), EQ.-1.0: bottom surface.
MAREA	Non-structural mass per unit area. This is additional mass which comes from materials such as carpeting. This mass is not directly included in the time step calculation. Another and often more convenient alternative for defining distributed mass is by the option: *ELEMENT_MASS_PART, which allows additional non-structural mass to be distributed by an area weighted distribution to all nodes of a given part ID).
IDOF	Treatment of through thickness strain. LT.0: Same as IDOF.EQ.3 but the contact pressure is averaged over a time $-IDOF$ in order to reduce noise and thus improve stability. EQ.1: The thickness field is continuous across the element edges for

<b>VARIABLE</b>	<b>DESCRIPTION</b>
	metalforming applications. This option applies to element types 25 and 26. EQ.2: The thickness field is discontinuous across the element edges. This is necessary for crashworthiness simulations due to shell intersections, sharp included angles, and non-smooth deformations. This option applies to element types 25, 26 and 27 and is mandatory for element 27. This is the default for these element types. EQ.3: The thickness strain is governed by the contact stress, meaning that the strain is adjusted for the through thickness stress to equilibrate the contact pressure. This option applies to element types 2 and 16.
EDGSET	Edge node set required for shell type seatbelts. Input an ordered set of nodes along one of the transverse edges of a seatbelt. If there is no retractor associated with a belt, the node set can be on either edge. If the retractor exists, the edge must be on the retractor side and input in the same sequence of retractor node set. Therefore, another restriction on the seatbelt usage is that each belt has its own section definition and, therefore, a unique part ID. See Figure 16.6 in the section *ELEMENT_SEATBELT for additional clarification.
B1	$\beta_1$ , material angle at first integration point
B2	$\beta_2$ , material angle at second integration point
B3	$\beta_3$ , material angle at third integration point
.	.
.	.
Bnip	$\beta_{nip}$ , material angle at niph integration point
DX,DY	Normalized dilation parameters of the kernel function in X and Y directions. The normalized dilation parameters of the kernel function are introduced to provide the smoothness and compact support properties on the construction of the mesh-free shape functions. Values between 1.0 and 2.0 are recommended. Values smaller than 1.0 are not allowed. Larger values will increase the computation time and will sometimes result in a divergence problem. See Remark 6.
ISPLINE	Replace the choice for the EFG kernel functions definition in *CONTROL_EFG. This allows users to define different ISPLINE in different sections.

---

<b>VARIABLE</b>	<b>DESCRIPTION</b>
IDILA	Replace the choice for the normalized dilation parameter definition in *CONTROL_EFG. This allows users to define different IDILA in different sections.
ITHELFM	Thermal shell formulation EQ.0: Default is governed by THSHEL on *CONTROL_SHELL EQ.1: Thick thermal shell EQ.2: Thin thermal shell
CMID	Cohesive material ID (only *MAT_COHESIVE_TH is available)
BASELM	Base element type for XFEM (type 13 for 2D, 16 for shell)
DOMINT	Option for domain integration in XFEM: EQ.0: Phantom element integration EQ.1: Subdomain integration with triangular local boundary integration (available in 2D only)
FAILCR	Option for different failure criteria: EQ.1: Maximum tensile stress EQ.2: Maximum shear stress
PROPCR	Not used
LPRINT	Debug printout option: EQ.0: No debug printout EQ.1: Print debug message
NIPP	Number of in-plane integration points for user-defined shell (0 if resultant/discrete element)
NXDOF	Number of extra degrees of freedom per node for user-defined shell
IUNF	Flag for using nodal fiber vectors in user-defined shell: EQ.0: Nodal fiber vectors are not used. EQ.1: Nodal fiber vectors are used.
IHFG	Flag for using hourglass stabilization (NIPP.GT.0) EQ.0: Hourglass stabilization is not used EQ.1: LS-DYNA hourglass stabilization is used EQ.2: User-defined hourglass stabilization is used EQ.3: Same as 2, but the resultant material tangent moduli are passed
ITAJ	Flag for setting up finite element matrices (NIPP.GT.0)

<u>VARIABLE</u>	<u>DESCRIPTION</u>
	EQ.0: Set up matrices wrt isoparametric domain EQ.1: Set up matrices wrt physical domain
LMC	Number of property parameters
NHSV	Number of history variables
ILOC	Coordinate system option: EQ.0: Pass all variables in LS-DYNA local coordinate system EQ.1: Pass all variables in global coordinate system
XI	First isoparametric coordinate
ETA	Second isoparametric coordinate
WGT	Isoparametric weight
PI	Ith property parameter



GAUSS INTEGRATION RULE					
NUMBER OF GAUSS POINT	1 POINT	2 POINT	3 POINT	4 POINT	5 POINT
#1	.0	-.5773503	.0	-.8611363	.0
#2		+.5773503	-.7745967	-.3399810	-.9061798
#3			+.7745967	+.3399810	-.5384693
#4				+.8622363	+.5384693
#5					+.9061798
NUMBER OF GAUSS POINT	6 POINT	7 POINT	8 POINT	9 POINT	10 POINT
#1	-.9324695	-.9491080	-.9702896	-.9681602	-.9739066
#2	-.6612094	-.7415312	-.7966665	-.8360311	-.8650634
#3	-.2386192	-.4058452	-.5255324	-.6133714	-.6794096
#4	+.2386192	.0	-.1834346	-.3242534	-.4333954
#5	+.6612094	+.4058452	+.1834346	0.0	-.1488743
#6	+.9324695	+.7415312	+.5255324	+.3242534	+.1488743
#7		+.9491080	+.7966665	+.6133714	+.4333954
#8			+.9702896	+.8360311	+.6794096
#9				+.9681602	+.8650634
#10					+.9739066

Location of through thickness Gauss integration points. The coordinate is referenced to the shell midsurface at location 0. The inner surface of the shell is at -1 and the outer surface is at +1.

LOBATTO INTEGRATION RULE					
NUMBER OF INTEG. POINT	-	-	3 POINT	4 POINT	5 POINT
#1			.0	-1.0	.0
#2			-1.0	-.4472136	-1.0
#3			+1.0	+.4472136	-.6546537
#4				+1.0	+.6546537
#5					+1.0
NUMBER OF INTEG. POINT	6 POINT	7 POINT	8 POINT	9 POINT	10 POINT
#1	-1.0	-1.0	-1.0	-1.0	-1.0
#2	-.7650553	-.8302239	-.8717401	-.8997580	-.9195339
#3	-.2852315	-.4688488	-.5917002	-.6771863	-.7387739
#4	+.2852315	.0	-.2092992	-.3631175	-.4779249
#5	+.7650553	+.4688488	+.2092992	.0	-.1652790
#6	+1.0	+.8302239	+.5917002	+.3631175	+.1652790
#7		+1.0	+.8717401	+.6771863	+.4779249
#8			+1.0	+.8997580	+.7387739
#9				+1.0	+.9195339
#10					+1.0

Location of through thickness Lobatto integration points. The coordinate is referenced to the shell midsurface at location 0. The inner surface of the shell is at -1 and the outer surface is at +1.

**Remarks:**

1. The default shell formulation is 2 unless overridden by THEORY in \*control\_shell.

For implicit calculations the following element formulations are implemented:

- EQ.2: Belytschko-Tsay (default)
- EQ.5: Belytschko-Tsay membrane,
- EQ.6: S/R Hughes-Liu,
- EQ.10: Belytschko-Wong-Chiang,
- EQ.12: Plane stress (x-y plane),
- EQ.13: Plane strain (x-y plane)
- EQ.15: Axisymmetric solid (y-axis of symmetry) - volume weighted,
- EQ.16: Fully integrated shell element,
- EQ.17: Fully integrated DKT, triangular shell element,
- EQ.18: Taylor 4-node quadrilateral and 3-node triangle (linear only)

- EQ.20: Wilson 3 & 4-node DSE quadrilateral (linear only)
- EQ.21: Fully integrated linear assumed strain C0 shell (5 DOF).
- EQ.22: Linear shear panel element (3 DOF per node)
- EQ.25: Belytschko-Tsay shell with thickness stretch.
- EQ.26: Fully integrated shell element with thickness stretch.
- EQ.27: Triangle with thickness stretch.

If another element formulation is requested for an implicit analysis, LS-DYNA will substitute one of the above in place of the one chosen.

2. The linear elements consist of an assembly of membrane and plate elements. The elements have six d.o.f. per node and can therefore be connected to beams, or used in complex shell surface intersections. All elements possess the required zero energy rigid body modes and have exact constant strain and curvature representation, i.e. they pass all the first order patch tests. In addition, the elements have behavior approaching linear bending (cubic displacement) in the plate-bending configuration.
  - a. The membrane component of all elements is based on an 8-node/6-node isoparametric mother element which incorporates nodal in-plane rotations through cubic displacement constraints of the sides [Taylor 1987; Wilson 2000].
  - b. The plate component of element 18 is based on the Discrete Kirchhoff Quadrilateral (DKQ) [Batoz 1982]. Because the Kirchhoff assumption is enforced, the DKQ is transverse shear rigid and can only be used for thin shells. No transverse shear stress information is available. The triangle is based on a degeneration of the DKQ. This element sometimes gives slightly lower eigenvalues when compared with element type 20.
  - c. The plate component of element 20 is based on the 8-node serendipity element. At the mid-side, the parallel rotations and transverse displacements are constrained and the normal rotations are condensed to yield a 4-node element. The element is based on thick plate theory and is recommended for thick and thin plates.
  - d. The quadrilateral elements contain a warpage correction using rigid links.
  - e. The membrane component of element 18 has a zero energy mode associated with the in-plane rotations. This is automatically suppressed in a non-flat shell by the plate stiffness of the adjacent elements. Element 20 has no spurious zero energy modes.
3. The linear shear panel element resist tangential in plane shearing along the four edges and can only be used with the elastic material constants of \*MAT\_ELASTIC. Membrane forces and out-of-plane loads are not resisted.
4. Element type 99 is intended for vibration studies carried out in the time domain. These models may have very large numbers of elements and may be run for relatively long durations. The purpose of this element is to achieve substantial CPU savings. This is achieved by imposing strict limitations on the range of applicability, thereby simplifying the calculations:
  - Elements must be rectangular; all edges must parallel to the global X-, Y- or Z-axis;

- Small displacement, small strain, negligible rigid body rotation;
- Elastic material only

If these conditions are satisfied, the performance of the element is similar to the fully integrated shell (ELFORM=16) but at less CPU cost than the default Belytschko-Tsay shell element (ELFORM=2). Single element torsion and in-plane bending modes are included; meshing guidelines are the same as for fully integrated shell elements.

No damping is included in the element formulation (e.g. volumetric damping). It is strongly recommended that damping be applied, e.g. \*DAMPING\_PART\_MASS or \*DAMPING\_FREQUENCY\_RANGE.

5. SHELL\_EFG formulation is only available for the explicit analysis.
6. Loads, lumped masses, discrete element stiffnesses, etc. in axisymmetric simulations are interpreted as values per unit length (circumferentially) in the case where shell formulation 14 is invoked and per unit radian in the case where shell formulation 15 is used.
7. Shell element formulation 25 and 26 are the Belytschko-Tsay element and fully integrated shell element with two additional degrees of freedom that allows a linear variation of strain through the thickness. By default, the thickness field is continuous across the element edges implying that there can be no complex intersections since this would lock up the structure. It assumes a relatively flat surface and is intended primarily for sheets in metal forming. By specifying IDOF=2, the thickness field is decoupled between elements which makes the element suited for crash. If there are any thickness stretch triangles (formulation 27), IDOF must be set to 2.
8. Users must input a set of nodes along one of the transverse edges of a seatbelt. If there is no retractor associated with a belt, the node set can be on either edge. If the retractor exists, the edge should be on the retractor side and input in the same sequence of retractor node set. Therefore, another restriction on the seatbelt usage is each belt has its own section definition and a different part.
9. XFEM 2D and shell formulations are recommended for brittle or semi-brittle fracture with pre-cracks. See \*BOUNDARY\_PRECRACK.

```
#####  
$  
$$$  *SECTION_SHELL  
$  
#####  
$  
$ Define a shell section that specifies the following:  
$   elform = 10  Belytschko-Wong-Chiang shell element formulation.  
$   nip = 3     Three through the shell thickness integration points.  
$   t1 - t4 = 2.0 A shell thickness of 2 mm at all nodes.  
$
```



**\*SECTION\_SOLID\_{OPTION}**

Available options include:

**<BLANK>**

**EFG**

such that the keyword cards appear:

**\*SECTION\_SOLID**

**\*SECTION\_SOLID\_EFG**

Purpose: Define section properties for solid continuum and fluid elements.

**Card 1 define for all options**

Card 1            1            2            3            4            5            6            7            8

Variable	SECID	ELFORM	AET					
Type	A8	I	I					
Remark		1, 2						

**Define only for the EFG option.**

Also see \*CONTROL\_EFG. See Remarks 8-12.

Card 2            1            2            3            4            5            6            7            8

Variable	DX	DY	DZ	ISPLINE	IDILA	IEBT	IDIM	TOLDEF
Type	F	F	F	I	I	I	I	F
Default	1.01	1.01	1.01	0	0	1	1	0.01

Card 3            1            2            3            4            5            6            7            8

Variable	IGL	STIME	IKEN	SF	CMID	IBR	DS	ECUT
Type	I	F	I	I	I	I	F	F
Default	0	1e+20	0	0.0		1	1.01	0.1

**Define if and only if ELFORM=101,102,103,104 or 105.**

Also see Appendix C

Card            1            2            3            4            5            6            7            8

Variable	NIP	NXDOF	IHGF	ITAJ	LMC	NHSV		
Type	I	I	I	I	I	I		
Default	0	0	0	0	0	0		

**Define NIP cards according to the following format.**

Also see Appendix C

Card            1            2            3            4            5            6            7            8

Variable	XI	ETA	ZETA	WGT				
Type	F	F	F	F				
Default	None	None	None	None				

**Define LMC property parameters using 8 parameters per card.**

Also see Appendix C

Card	1	2	3	4	5	6	7	8
Variable	P1	P2	P3	P4	P5	P6	P7	P8
Type	F	F	F	F	F	F	F	F
Default	0	0	0	0	0	0	0	0

<u>VARIABLE</u>	<u>DESCRIPTION</u>
SECID	Section ID. SECID is referenced on the *PART card. A unique number or label not exceeding 8 characters must be specified.
ELFORM	<p>Element formulation options, (see Remark 2 below):</p> <p>EQ.-2: fully integrated S/R solid intended for elements with poor aspect ratio, accurate formulation.</p> <p>EQ.-1: fully integrated S/R solid intended for elements with poor aspect ratio, efficient formulation.</p> <p>EQ.0: 1 point corotational for *MAT_MODIFIED_HONEYCOMB. See remark 3.</p> <p>EQ.1: constant stress solid element (default),</p> <p>EQ.2: fully integrated S/R solid. See remark 4 below,</p> <p>EQ.3: fully integrated quadratic 8 node element with nodal rotations,</p> <p>EQ.4: S/R quadratic tetrahedron element with nodal rotations,</p> <p>EQ.5: 1 point ALE,</p> <p>EQ.6: 1 point Eulerian,</p> <p>EQ.7: 1 point Eulerian ambient,</p> <p>EQ.8: acoustic,</p> <p>EQ.9: 1 point corotational for *MAT_MODIFIED_HONEYCOMB. See remark 3.</p> <p>EQ.10: 1 point tetrahedron.</p> <p>EQ.11: 1 point ALE multi-material element</p> <p>EQ.12: 1 point integration with single material and void.</p> <p>EQ.13: 1 point nodal pressure tetrahedron. See remark 14 below.</p> <p>EQ.14: 8 point acoustic</p> <p>EQ.15: 2 point pentahedron element.</p> <p>EQ.16: 4 or 5 point 10-noded tetrahedron (See Remark 13)</p> <p>EQ.17: 10-noded composite tetrahedron</p> <p>EQ.18: 8 point enhanced strain solid element for linear statics only</p> <p>EQ.19: 4 point cohesive element</p>



VARIABLE	DESCRIPTION
	EQ.20: 4 point cohesive elements with offsets for use with shells EQ.41: Mesh-free (EFG) solid formulation EQ.42: 4-noded mesh-free (EFG) solid formulation EQ.98: Interpolation solid EQ.99: simplified linear element for time-domain vibration studies. See remarks. GT.100.and.LT.106: User defined solid EQ.115: 1 point pentahedron element with hourglass control GE.1000: Generalized solid element formulation (user defined). See *DEFINE_ELEMENT_GENERALIZED_SOLID
AET	Ambient Element type: Can be defined for ELFORM 7, 11 and 12. EQ.1: temperature (not currently available), EQ.2: pressure and temperature (not currently available), EQ.3: pressure outflow (obsolete), EQ.4: pressure inflow/outflow. (Default for ELFORM 7), EQ.5: receptor for blast load (see *LOAD_BLAST_ENHANCED, available only for ELFORM=11).
DX, DY, DZ	Normalized dilation parameters of the kernel function in X, Y and Z directions. The normalized dilation parameters of the kernel function are introduced to provide the smoothness and compact support properties on the construction of the mesh-free shape functions. Values between 1.0 and 1.5 are recommended. Values smaller than 1.0 are not allowed. Larger values will increase the computation time and will sometimes result in a divergence problem.
ISPLINE	Replace the choice for the EFG kernel functions definition in *CONTROL_EFG. This allows users to define different ISPLINE in different sections. EQ.0: Cubic spline function (default). EQ.1: Quadratic spline function. EQ.2: Cubic spline function with circular shape.
IDILA	Replace the choice for the normalized dilation parameter definition in *CONTROL_EFG. This allows users to define different IDILA in different sections. EQ.0: Maximum distance based on the background elements. EQ.1: Maximum distance based on surrounding nodes.
IEBT	Essential boundary condition treatment: See Remark 9 and 10. EQ. 1: Full transformation method (default) EQ.-1: (w/o transformation) EQ. 2: Mixed transformation method EQ. 3: Coupled FEM/EFG method

<b>VARIABLE</b>	<b>DESCRIPTION</b>
	EQ. 4: Fast transformation method EQ.-4: (w/o transformation) EQ.5: Fluid particle method for E.O.S and *MAT_ELASTIC_FLUID materials
IDIM	Domain integration method: See Remark 11. EQ.1: Local boundary integration (default) EQ.2: Two-point Gauss integration EQ.3: Improved Gauss integration for IEBT=4 or -4
TOLDEF	Deformation tolerance for the activation of adaptive EFG Semi-Lagrangian and Eulerian kernel. See Remark 12. = 0.0: Lagrangian kernel > 0.0: Semi_Lagrangian kernel < 0.0: Eulerian kernel
IGL	EQ.0: local Eulerian kernel or semi-Lagrangian kernel activation (fast) EQ.1: global Eulerian kernel or semi-Lagrangian kernel activation (slow)
STIME	Time to switch from stabilized EFG to standard EFG formulation
IKEN	EQ.0: Moving-least-square approximation (default, recommended) EQ.1: Maximum Entropy approximation
SF	Failure strain, recommended as an extra condition for the crack initiation under slow loading besides the stress-based cohesive law
CMID	Cohesive material ID for EFG fracture analysis (only Mode I crack is considered and only *MAT_COHESIVE_TH is available)
IBR	EQ.1: No branching allowed EQ.2: Branching is allowed
DS	Normalized support defined for computing the displacement jump in fracture analysis
ECUT	Define the minimum distance to the node that a crack surface can cut to the edge
NIP	Number of integration points for user-defined solid (0 if resultant/discrete element)
NXDOF	Number of extra degrees of freedom per node for user-defined solid

VARIABLE	DESCRIPTION
IHGF	<b>Flag for using hourglass stabilization (NIP.GT.0)</b> EQ.0: Hourglass stabilization is not used EQ.1: LS-DYNA hourglass stabilization is used EQ.2: User-defined hourglass stabilization is used EQ.3: Same as 2, but the resultant material tangent modulus is passed
ITAJ	Flag for setting up finite element matrices (NIP.GT.0) EQ.0: Set up matrices wrt isoparametric domain EQ.1: Set up matrices wrt physical domain
LMC	Number of property parameters
NHSV	Number of history variables
XI	First isoparametric coordinate
ETA	Second isoparametric coordinate
ZETA	Third isoparametric coordinate
WGT	Isoparametric weight
PI	Ith property parameter

### **Remarks:**

1. The keyword \*CONTROL\_SOLID activates automatic sorting of tetrahedron and pentahedron elements into type 10 and 15 element formulation, respectively. These latter elements are far more stable than the degenerate solid element. The sorting is performed internally and is transparent to the user.
2. For implicit calculations the following element choices are implemented:
  - EQ.1: constant stress solid element,
  - EQ.2: fully integrated S/R solid. See remark 5 below,
  - EQ.3: fully integrated 8 node solid with rotational DOFs,
  - EQ.4: fully integrated S/R 4 node tetrahedron with rotational DOFs,
  - EQ.10: 1 point tetrahedron.
  - EQ.13: 1 point nodal pressure tetrahedron.
  - EQ.15: 2 point pentahedron element.
  - EQ.16: 5 point 10 noded tetrahedron
  - EQ.17: 10-noded composite tetrahedron
  - EQ.18: 8 point enhanced strain solid element for linear statics only

If another element formulation is requested, LS-DYNA will substitute, when possible, one of the above in place of the one chosen. The type 1 element, constant stress, is generally much more accurate than the type 2 element, the selective reduced integrated element for implicit problems.

3. Element formulations 0 and 9, applicable only to `*MAT_MODIFIED_HONEYCOMB`, behave essentially as nonlinear springs so as to permit severe distortions sometimes seen in honeycomb materials. In formulation 0, the local coordinate system follows the element rotation whereas in formulation 9, the local coordinate system is based on axes passing through the centroids of the element faces. Formulation 0 is preferred for severe shear deformation where the barrier is fixed in space. If the barrier is attached to a moving body, which can rotate, then formulation 9 is usually preferred.
4. The selective reduced integrated solid element, element type 2, assumes that pressure is constant throughout the element to avoid pressure locking during nearly incompressible flow. However, if the element aspect ratios are poor, shear locking will lead to an excessively stiff response. A better choice, given poor aspect ratios, is the one point solid element which work well for implicit and explicit calculations. For linear statics, the type 18 enhanced strain element works well with poor aspect ratios. Please note that highly distorted elements should always be avoided since excessive stiffness will still be observed even in the enhanced strain formulations.
5. Element type 99 is intended for vibration studies carried out in the time domain. These models may have very large numbers of elements and may be run for relatively long durations. The purpose of this element is to achieve substantial CPU savings. This is achieved by imposing strict limitations on the range of applicability, thereby simplifying the calculations:
  - Elements must be cubed; all edges must parallel to the global X-, Y- or Z-axis;
  - Small displacement, small strain, negligible rigid body rotation;
  - Elastic material only

If these conditions are satisfied, the performance of the element is similar to the fully integrated S/R solid (ELFORM=2) but at less CPU cost than the default solid element (ELFORM=1). Single element bending and torsion modes are included, so meshing guidelines are the same as for fully integrated solids – e.g. relatively thin structures can be modeled with a single solid element through the thickness if required. Typically, the CPU requirement per element-cycle is roughly two thirds that of the default solid element.

No damping is included in the element formulation (e.g. volumetric damping). It is strongly recommended that damping be applied, e.g. `*DAMPING_PART_MASS` or `*DAMPING_FREQUENCY_RANGE`.

6. Element type 19 is a cohesive element. The tractions on the mid-surface defined as the mid-points between the nodal pairs 1-5, 2-6, 3-7, and 4-8 are functions of the differences of the displacements between nodal pairs interpolated to the four integration points. The initial volume of the cohesive element may be zero, in which case, the density may be

defined in terms of the area of nodes 1-2-3-4. See Appendix A and the user material description for additional details.

The tractions are calculated in the local coordinate system defined at the centroid of the element, see the Figure below. Defining the rotation matrix from the local to the global coordinate system at time  $t$  as  $R(t)$ , the initial coordinates as  $X$ , and the current coordinates as  $x$ , the displacements at an integration point are

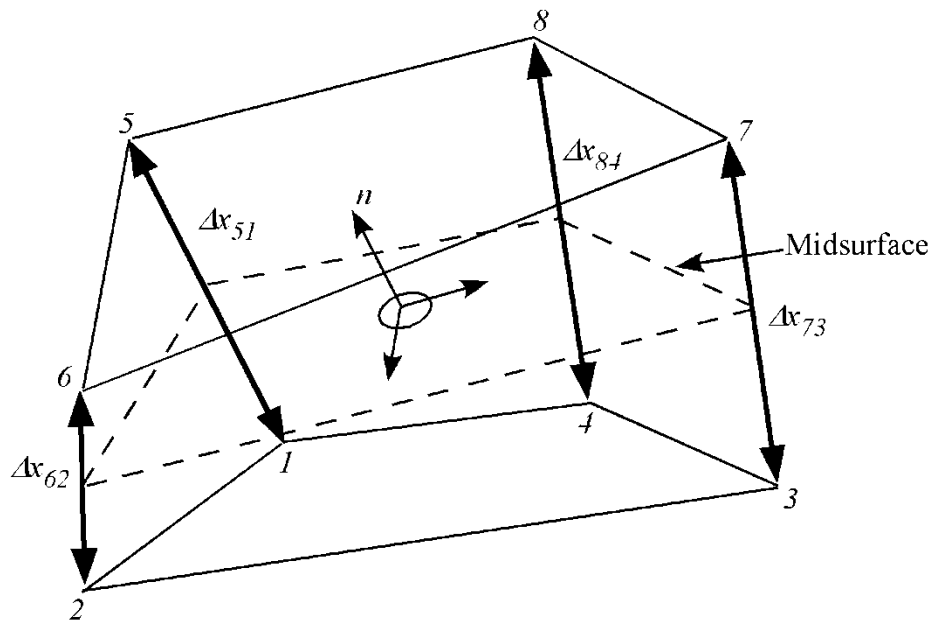
$$\begin{aligned}\Delta u &= R^T(t)\Delta x - R^T(0)\Delta X \\ \Delta x &= \sum_{i=1}^4 N_i(s,t)\Delta x_{i+4,i} \\ \Delta X &= \sum_{i=1}^4 N_i(s,t)\Delta X_{i+4,i}\end{aligned}$$

The forces are obtained by integrating the tractions over the midsurface, and rotating them into the global coordinate system.

$$F_i = R(t) \sum_{g=1}^4 t_g N_i(s_g, t_g) \det(J_g) \text{ for } i=1,4 \text{ and } F_{i+4} = -F_i$$

7. Element type 20 is identical to element 19 but with offsets for use with shells. The element is assumed to be centered between two layers of shells on the cohesive element's lower (1-2-3-4) and upper (5-6-7-8) surfaces. The offset distances for both shells are one half the initial thicknesses of the nodal pairs (1-5, 2-6, 3-7, and 4-8) separating the two shells. These offsets are used with the nodal forces to calculate moments that are applied to the shells.
8. The current EFG formulation performs automatic sorting for finite element tetrahedral, pentahedron and hexahedral elements as the background mesh to identify the mesh-free geometry and provide the contact surface definition in the computation.
9. The mixed transformation method, the coupled FEM/EFG method and the fast transformation method were implemented in EFG 3D solid formulation. These three new features were added to improve the efficiency on the imposition of essential boundary conditions and the transfer of real nodal values and generalized nodal values. The mixed transformation method is equivalent to the full transformation method with improved efficiency. The behavior of the coupled FEM/EFG method is between FEM and EFG. The fast transformation method provides the most efficient and robust results.
10. Current fluid particle formulation (IEBT=5) only supports for the 4-noded background element.
11. For compressible material like foam and soil, IDIM=1 (default) is recommended. For nearly incompressible material like metal and rubber, IDIM=2 is recommended.

12. This parameter is introduced to improve the negative volume problem usually seen in the large deformation analysis. For the same analysis, the larger value of Toldef, the earlier Semi-Lagrangian or Eulerian kernel is introduced into the EFG computation and more cpu time is expected. Value between 0.0 and 0.1 is suggested in the crashworthiness analysis. Semi-Lagrangian kernel is suggested for the solid materials and Eulerian kernel is suggested for the fluid and E.O.S. materials.



**Figure 32.2**

13. Formulations 16 and 17 are 10-noded, tetrahedral formulations. The parameter NIPTETS in \*CONTROL\_SOLID controls the number of integration points for these formulations. Formulation 17 is generally preferred over formulation 16 because, unlike 16, the nodal weighting factors are equal and thus nodal forces from contact and applied pressures are distributed correctly.

When applying loads to 10-noded tetrahedrons via segments, no load will be applied to the midside nodes if the segments contain only corner nodes. When defining contact, it is recommended that \*CONTACT\_AUTOMATIC\_... be used and the contact surface of the 10-noded tetrahedral part be specified by its part ID. In this manner, midside nodes receive contact forces.

If the 10-noded element connectivity is not defined in accordance with the figure shown in \*ELEMENT\_SOLID, the order of the nodes can be quickly changed via a permutation vector specified with \*CONTROL\_SOLID. If \*ELEMENT\_SOLID defines 4-noded tetrahedrons, you can easily convert to 10-noded tetrahedrons using the command \*ELEMENT\_SOLID\_TET4TOTET10. Because the characteristic length of a 10-noded tetrahedron is half that of a 4-noded tetrahedron, the time step for the tetrahedrons will be smaller by a factor of 2. The parameter TET10 in 971, when set to 1 in

\*CONTROL\_OUTPUT, causes the full 10-node connectivity to be written to the d3plot and d3part databases.

- 14. Element type 13 is identical with type 10 but with additional averaging of nodal pressures, which significantly lowers volumetric locking. Therefore, it is well suited for applications with incompressible and nearly incompressible material behavior, i.e. rubber materials or ductile metals with isochoric plastic deformations (e.g. bulk forming). Compared to the standard tetrahedron (type 10), a speed penalty of max. 25 % can be observed. Currently, material models \*MAT\_ 001, 003, 006, 024, 027, 077, 081, 082, 091, 092, 106, 120, 123, 124, 128, 129, 181, 183, 224, 225, and 244 are fully supported in the R6 release of Version 971. For other materials this element behaves like the type 10 tetrahedron.
- 15. Elements -1 and -2 are identical with 2, the fully integrated solid, but accounted for elements with poor aspect ratio in order to reduce the transverse shear locking effects. Type -1 is an efficient implementation of type -2 but that may suffer from some hourglass tendencies due to inadequate loss of stiffness.

(Note: NODE\_SET option is available starting with the R3 release of Version 971)

```

$$$$$$$$$$$$$$$$$$$$$$$$$$$$$$$$$$$$$$$$$$$$$$$$$$$$$$$$$$$$$$$$$$$$$$$$$$$$$$$$$$$$$$$$
$
$$$$ *SECTION_SOLID
$
$$$$$$$$$$$$$$$$$$$$$$$$$$$$$$$$$$$$$$$$$$$$$$$$$$$$$$$$$$$$$$$$$$$$$$$$$$$$$$$$$$$$$$$$
$
$ A bolt modeled with solids was found to have excessive hourglassing.
$ Thus, the section (sid = 116) associated with the bolt part was used
$ to specify that a fully integrated Selectively-Reduced solid element
$ formulation be used to totally eliminate the hourglassing (elform = 2).
$
*SECTION_SOLID
$.>....1.>....2.>....3.>....4.>....5.>....6.>....7.>....8
$   sid   elform
$     116      2
$
*PART
bolts
$   pid     sid     mid     eosid     hgid     adpopt
$     17     116      5
$
$$$$$$$$$$$$$$$$$$$$$$$$$$$$$$$$$$$$$$$$$$$$$$$$$$$$$$$$$$$$$$$$$$$$$$$$$$$$$$$$$$$$$$$$

```

**\*SECTION\_SPH\_{OPTION}**

Available options include:

**<BLANK>**

**TENSOR**

**USER**

such that the keyword cards appear:

**\*SECTION\_SPH**

**\*SECTION\_SPH\_TENSOR**

**\*SECTION\_SPH\_USER**

Purpose: Define section properties for SPH particles. For the **USER** option, see remark 3.

**Card 1 define for all options**

Card 1            1            2            3            4            5            6            7            8

Variable	SECID	CSLH	HMIN	HMAX	SPHINI	DEATH	START	
Type	A8	F	F	F	F	F	F	
Default	none	1.2	0.2	2.0	0.0	1.e20	0.0	

**Card 2 define only for the TENSOR option.**

Card 2            1            2            3            4            5            6            7            8

Variable	HXCSLH	HYCSLH	HZCSLH	HXINI	HYINI	HZINI		
Type	F	F	F	F	F	F		

<u>VARIABLE</u>	<u>DESCRIPTION</u>
SECID	Section ID. SECID is referenced on the *PART card. A unique number or label not exceeding 8 characters must be specified.



<u>VARIABLE</u>	<u>DESCRIPTION</u>
CSLH	Constant applied to the smoothing length of the particles. The default value applies for most problems. Values between 1.05 and 1.3 are acceptable. Taking a value less than 1 is inadmissible. Values larger than 1.3 will increase the computational time. The default value is recommended.
HMIN	Scale factor for the minimum smoothing length (See Remark 1)
HMAX	Scale factor for the maximum smoothing length (See Remark 1)
SPHINI	Optional initial smoothing length (overrides true smoothing length). This option applies to avoid LS-DYNA to calculate the smoothing length during initialization. In this case, the variable CSLH doesn't apply.
DEATH	Time imposed SPH approximation is stopped.
START	Time imposed SPH approximation is activated.
HXCSLH	Constant applied for the smoothing length in the X direction for the tensor case.
HYCSLH	Constant applied for the smoothing length in the Y direction for the tensor case.
HZCSLH	Constant applied for the smoothing length in the Z direction for the tensor case.
HXINI	Optional initial smoothing length in the X direction for the tensor case (overrides true smoothing length)
HYINI	Optional initial smoothing length in the Y direction for the tensor case (overrides true smoothing length)
HZINI	Optional initial smoothing length in the Z direction for the tensor case (overrides true smoothing length)

**Remarks:**

1. The SPH processor in LS-DYNA uses a variable smoothing length. LS-DYNA computes the initial smoothing length,  $h_0$ , for each SPH part by taking the maximum of the minimum distance between every particle. Every particle has its own smoothing length which varies in time according to the following equation:

$$\frac{d}{dt}(h(t)) = h(t)\text{div}(v)$$

$h(t)$  is the smoothing length,  $\text{div}(\mathbf{v})$  is the divergence of the flow. The smoothing length increases when particles separate from each other and reduces when the concentration of particles is important. It varies to keep the same number of particles in the neighborhood. The smoothing length varies between the minimum and maximum values

$$HMIN * h_0 < h(t) < HMAX * h_0$$

Defining a value of 1 for HMIN and 1 for HMAX will result in a constant smoothing length in time and space.

2. SPH is implemented for explicit applications.
3. The USER option allows the definition of customized subroutine for the variation of the smoothing length. A subroutine called hdot is defined in the file dyn21.F (Unix/linux) or lsdyna.f (Windows).

\*SECTION\_TSHELL

Purpose: Define section properties for thick shell elements.

Card 1            1            2            3            4            5            6            7            8

Variable	SECID	ELFORM	SHRF	NIP	PROPT	QR	ICOMP	TSHEAR
Type	A8	I	F	F	F	F	I	I
Default	none	1	1.0	2	1	0	0	0

**Optional Section Cards if ICOMP=1 define NIP angles putting 8 on each card.**

Card 2...        1            2            3            4            5            6            7            8

Variable	B1	B2	B3	B4	B5	B6	B7	B8
Type	F	F	F	F	F	F	F	F

<u>VARIABLE</u>	<u>DESCRIPTION</u>
SECID	Section ID. SECID is referenced on the *PART card. A unique number or label not exceeding 8 characters must be specified.
ELFORM	Element formulation: EQ.1: one point reduced integration (default), EQ.2: selective reduced 2 x 2 in plane integration. EQ.3: assumed strain 2 x 2 in plane integration, see remark below. EQ.5: assumed strain reduced integration
SHRF	Shear factor. A value of 5/6 is recommended (see remark 3).
NIP	Number of through shell thickness integration points: EQ.0: set to 2 integration points.
PROPT	Printout option: EQ.1.0: average resultants and fiber lengths, EQ.2.0: resultants at plan points and fiber lengths, EQ.3.0: resultants, stresses at all points, fiber lengths.

<b>VARIABLE</b>	<b>DESCRIPTION</b>
QR	Quadrature rule: LT.0.0: absolute value is specified rule number, EQ.0.0: Gauss (up to five points are permitted), EQ.1.0: trapezoidal, not recommended for accuracy reasons.
ICOMP	Flag for layered composite material mode: EQ.1: a material angle is defined for each through thickness integration point. For each layer one integration point is used.
TSHEAR	Flag for transverse shear strain or stress distribution (see remarks 3 and 4): EQ.0.0: Parabolic, EQ.1.0: Constant through thickness.
B1	$\beta_1$ , material angle at first integration point. The same procedure for determining material directions is use for thick shells that is used for the 4 node quadrilateral shell.
B2	$\beta_2$ , material angle at second integration point
B3	$\beta_3$ , material angle at third integration point
.	.
.	.
.	.
B8	$\beta_8$ , material angle at eighth integration point
.	.
Bnip	$\beta_{nip}$ , material angle at niph integration point

Define as many cards as necessary until NIP points are defined.

**Remarks:**

1. Thick shell formulation types 3 and 5 use a full three-dimensional stress update rather than the two-dimensional plane stress update of types 1 and 2. The type 3 and 5 elements are distortion sensitive and should not be used in situations where the elements are badly shaped. With element types 1, 2, and 5, a single element through the thickness will capture bending response, but with element type 3, two are recommended to avoid excessive softness.

2. Element formulations 2 and 3 are available for implicit applications. If an element of type 1 is specified in an implicit analysis, it is internally switched to type 2
3. For element formulations 1, 2, and 3, the out-of-plane shear strain is assumed constant through the thickness. For element formulation 5, the transverse shear strain is assumed by default to have a parabolic thru-thickness distribution. The parabolic assumption is good when the elements are used in a single layer to model a shell type structure, but less good when elements are stacked one on top of the other. Setting TSHEAR=1 switches the parabolic assumption of element formulation 5 to constant. When the transverse shear strain is assumed constant through the thickness, setting SHRF=5/6 compensates for the error in the distribution to obtain the correct overall transverse shear stiffness in the element. This correction is not needed for the parabolic distribution and SHRF=1.0 is recommended.
4. Thick shell elements of all formulations can be used to model layered composites, but only element formulation 5 uses assumed strain to capture the complex transverse and through thickness stress distribution in layered composites. To define the layers of a composite, use QR<0 to point to \*INTEGRATION\_SHELL data. Alternatively, the \*PART\_COMPOSITE\_TSHELL keyword offers a simplified way to define the layers. The parabolic shear strain distribution discussed in note 3 is not sufficient for composite models that typically have transverse shear stiffness that varies from layer to layer. Therefore, composite models typically use laminated shell theory, activated by setting LAMSHT=4 or 5 on \*CONTROL\_SHELL, to correct the transverse shear stress distribution. When laminated shell theory is active, TSHEAR=0 is recommended if elements are used in a single layer, and TSHEAR=1 is recommended if more than 1 layer of elements is used. The TSHEAR parameter is available for all ELFORM values when laminated shell theory is active.



# **\*SENSOR**

The keyword **\*SENSOR** provides a convenient way of activating and deactivating boundary conditions, airbags, discrete elements, joints, contact, rigid walls, single point constraints, and constrained nodes. The sensor capability is new in the second release of version 971 and will evolve in later releases to encompass many more LS-DYNA capabilities and replace some of the existing capabilities such as the airbag sensor logic. The keyword control cards in this section are defined below in alphabetical order:

**\*SENSOR\_CONTROL**

**\*SENSOR\_DEFINE\_CALC-MATH**

**\*SENSOR\_DEFINE\_ELEMENT**

**\*SENSOR\_DEFINE\_FORCE**

**\*SENSOR\_DEFINE\_NODE**

**\*SENSOR\_SWITCH**

**\*SENSOR\_SWITCH\_CALC-LOGIC**

To define a sensor, three categories of sensor keyword cards are needed as shown in Figure 33.1.

1. Sensor definitions using the, **\*SENSOR\_DEFINE** keywords, which can be combined with the mathematical calculation cards, **\*SENSOR\_DEFINE\_CALC-MATH**, for more complicated definitions. This category of keyword cards yield a numerical value to be referred by **\*SENSOR\_SWITCH** as a switching criterion.
  - **\*SENSOR\_DEFINE**  
This card defines the sensor location and types by node ID, element ID, or force-type ID.
  - **\*SENSOR\_DEFINE\_CALC-MATH**  
This keyword card defines a new sensor ID obtained by performing mathematical calculations on the information from **SENSOR\_DEFINE** definitions.
2. Sensor switching criterion definition using the, **\*SENSOR\_SWITCH**, keyword, which can be combined with the logical calculation cards, **\*SENSOR\_SWITCH\_CALC-LOGIC**, for more complicated definitions. The logic value yielded by this category of cards can be referred by **\*SENSOR\_CONTROL** to determine if a status switch condition is met.
  - **\*SENSOR\_SWITCH**

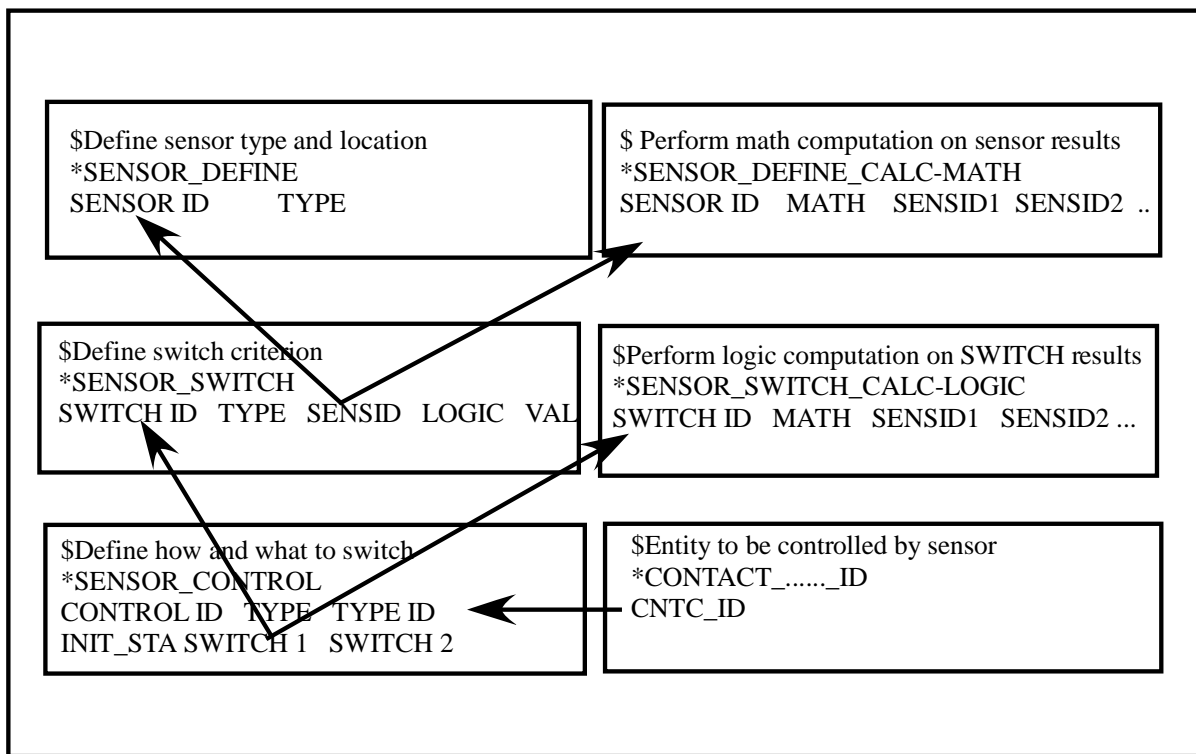
# \*SENSOR

This card compares the numerical value from \*SENSOR\_DEFINE or \*SENSOR\_DEFINE\_CALC-MATH with the given criterion to see if a switching condition is met.

- \*SENSOR\_SWITCH\_CALC-LOGIC

This card performs logical calculation on the information from SENSOR\_SWITCH.

3. Sensor control definition, \*SENSOR\_CONTROL. This category of cards determines how and what to switch based on the logical values from \*SENSOR\_SWITCH and/or \*SENSOR\_SWITCH\_CALC-LOGIC.



**Figure 33.1.** Relationship between sensor keyword definitions.



**\*SENSOR\_CONTROL**

Purpose: This command, based on the information of \*SENSOR\_SWITCH, controls the status, on or off, of an entity like \*CONTACT, \*AIRBAG.

Card 1            1            2            3            4            5            6            7            8

Variable	CNTLID	TYPE	TYPEID	TIMEOFF				
Type	I	A	I	F				

Card 2            1            2            3            4            5            6            7            8

Variable	INITSTT	SWIT1	SWIT2	SWIT3	SWIT4	SWIT5	SWIT6	SWIT7
Type	A	I	I	I	I	I	I	I

<u>VARIABLE</u>	<u>DESCRIPTION</u>
CNTLID	Sensor control ID.
TYPE	Entity to be controlled: EQ.AIRBAG:        for *AIRBAG EQ.PRESC-MOT:    for *boundary_prescribed motion EQ.DISC-ELE:     for *ELEMENT_DISCRETE EQ.JOINT:         for *constrained_joint EQ.JOINTSTIF:    for *constrained_joint_STIFFNESS EQ.CONTACT:      for *CONTACT EQ.RWALL:         for *RIGID_WALL EQ.SPC:            for *BOUNDARY_SPC EQ.SPOTWELD:     for *CONSTRAINED_SPOTWELD EQ.PRESSURE:     for *LOAD_SEGMENT EQ.DEF2RIG:      for *DEFORMABLE_TO_RIGID_AUTOMATIC EQ.FUNCTION:     for *DEFINE_CURVE_FUNCTION
TYPEID	ID of entity to be controlled if TYPE is not set to FUNCTION; See Remark 1 if TYPE is set to FUNCTION.

<b>VARIABLE</b>	<b>DESCRIPTION</b>
TIMEOFF	=1 when the abscissa of related time-dependent curve is requested to be offset by the time when the sensor control is turned on: LCID of *LOAD_SEGMENT when TYPE is PRESSURE, LCID of *BOUNDARY_PRESCRIBED_MOTION when TYPE is PRESC-MOT.
INITSTT	Initial status: EQ.On: EQ.Off:
SWIT1	ID of switch which will change the initial status after its condition is met.
SWITn	ID of nth switch which will change the status set by switch n-1 after its condition is met.

**Remarks:**

1. When the input parameter TYPE of \*SENSOR\_CONTROL is set to "FUNCTION", the function "SENSOR(cntlid)" as described in \*DEFINE\_CURVE\_FUNCTION takes on a value that depends on the current status of the \*SENSOR\_CONTROL. That status is either on or off at any given point in time. If the status is on, the value of function SENSOR(cntlid) is simply set to 1.0. If the status is off, the value of function SENSOR(cntlid) is set to the input parameter TYPEID as specified in \*SENSOR\_CONTROL. To help clarify this relationship between \*SENSOR\_CONTROL and \*DEFINE\_CURVE\_FUNCTION, consider the following example.

Suppose a \*SENSOR\_CONTROL defined with CNTLID=101, TYPE="FUNCTION", and TYPEID=-1.5 has a status of off. Then a \*DEFINE\_CURVE\_FUNCTION defined as "2+3\*sensor(101)" will have a value of  $2 + 3*(-1.5) = -2.5$ . On the other hand, if the status of the \*SENSOR\_CONTROL changes to on, the \*DEFINE\_CURVE\_FUNCTION takes on a value of 1.0.

2. DEF2RIG provides users more flexibility controlling material switch between rigid and deformable. Status of ON trigger the switch and deformable material becomes rigid. Rigidized material can then return to deformable status when status becomes OFF. As many as 7 SWITs can be input, any of them will change the status triggered by its preceding SWIT or the initial condition, INTSTT.

**\*SENSOR\_DEFINE\_CALC-MATH**

Purpose: Defines a new sensor with a unique ID. The values associated with this sensor are computed by performing mathematical calculations with the information obtained from sensors defined by the \*SENSOR\_DEFINE\_OPTION.

Card            1            2            3            4            5            6            7            8

Variable	SENSID	CALC	SENS1	SENS2	SENS3	SENS4	SENS5	SENS6
Type	I	A	I	I	I	I	I	I

<u>VARIABLE</u>	<u>DESCRIPTION</u>
SENSID	Sensor ID.
CALC	Mathematical calculation, See Table 33.1.
SENSi	ith Sensor ID

<b>CALC</b>	<b>DESCRIPTION</b>	<b>MATHEMATICAL EXPRESSION</b>
ABSSUM	Absolute value of the sum of sensor values	sens1+sens2+...
MIN	The minimum of sensor values	Min (sens1, sens2, ...)
MAX	The maximum of sensor values	Max (sens1, sens2, ...)
MAXMAG	The maximum of magnitude of sensor values	Max ( sens1 ,  sens2 ...)
MINMAG	The minimum of the magnitude of sensor values	Min ( sens1 ,  sens2 ...)
MULTIPLY	Multiplication of sensor values; negative for division (performed left to right)	sens1* sens2* sens3...
SQRE	Summation of squared values of sensor values	Sens1^2+sens2^2...
SQRTSQRE	Square root of the sum of squared values	SQRT (sens1^2+sens2^2+...)
SQRT	Summation of square root of sensor values; negative for subtracting values	(sens1)**0.5+ (sens2) **0.5...
SUMABS	Summation of absolute sensor values	sens1 + sens2 +...
SUM	Summation of sensor values; negative for subtracting values	sens1+sens2+...

**Table 33.1.** Available mathematical functions.

**\*SENSOR\_DEFINE\_ELEMENT\_{OPTION}**

Available options include:

<BLANK>

**SET**

Purpose: Define a strain gage type element sensor that checks the stress, strain, or resultant force of an element or element set.

Card            1            2            3            4            5            6            7            8

Variable	SENSID	ETYPE	ELEMID	COMP	CTYPE	LAYER		
Type	I	A	I	A	A	A		

<u>VARIABLE</u>	<u>DESCRIPTION</u>
SENSID	Sensor ID.
ETYPE	Element type: EQ.BEAM:        beam element. EQ.SHELL:       shell element EQ.SOLID:       solid element EQ.DISC-ELE:   discrete element
ELEMID	Element ID or element set ID when option <u>_SET</u> is active. In case of option <u>_SET</u> , a positive ELEMID requires all elements in set ELEMID to meet the switch condition to switch the status of related *SENSOR_SWITCH. If ELEMID is negative, the status of related *SENSOR_SWITCH will be changed if at least one of elements in set “-ELEMID” meets the switch condition.

---

<b>VARIABLE</b>	<b>DESCRIPTION</b>
COMP	Element type: EQ.XX: x-normal component for shells and solids EQ.YY: y-normal component for shells and solids EQ.ZZ: z-normal component for shells and solids EQ.XY: xy-shear component for shells and solids EQ.YZ: yz-shear component for shells and solids EQ.ZX: zx-shear component for shells and solids EQ.AXIAL: axial EQ.SHEARS: local s-direction EQ.SHEART: local t-direction EQ: leave blank for discrete elements
CTYPE	Component type: EQ.STRAIN: strain component for shells and solids EQ.STRESS: stress component for shells and solids EQ.FORCE: force resultants for beams EQ.MOMENT: moment resultants for beams EQ.FORCE: discrete element force EQ.DLEN: change in length for discrete element
LAYER	Layer of integration point in shell element EQ.BOT: component at lower surface EQ.TOP: component at upper surface

**\*SENSOR\_DEFINE\_FORCE**

Purpose: Define a force transducer type sensor.

Card            1            2            3            4            5            6            7            8

Variable	SENSID	FTYPE	TYPEID	VID	CRD			
Type	I	A	I	A/I	I			

<u>VARIABLE</u>	<u>DESCRIPTION</u>
SENSID	Sensor ID.
FTYPE	Force type. See Table 33.2.
TYPEID	ID defined in the associated KEYWORD command. See Table 33.2.
VID	Vector along which the forces is measured. EQ.X:            x-direction in coordinate system CRD. EQ.Y:            y-direction in coordinate system CRD. EQ.Z:            z-direction in coordinate system CRD. EQ.XMOMENT: x-direction moment for JOINT. EQ.YMOMENT: y-direction moment for JOINT. EQ.ZMOMENT: z-direction moment for JOINT. EQ.n:            vector ID n in coordinate system CRD.
CRD	Coordinate system, defined by *DEFINE_COORDINATE_NODES, to which VECT is attached.

<b>FTYPE</b>	<b>TYPEID</b> (Enter ID defined in following <b>KEYWORD</b> commands)	<b>OUTPUT</b>	<b>ASCII FILE</b>
AIRBAG	*AIRBAG	Airbag pressure	ABSTAT
CONTACT	*CONTACT	Contact force	RCFORC
JOINT	*CONSTRAINED_JOINT	Joint force	JNTFORC
JOINTSTIF	*CONSTRAINED_JOINT_STIFFNESS	Joint stiffness force	NA
PRESC-MOT	*BOUNDARY_PRESCRIBED_MOTION	Prescribed motion force	BNDOUT
RWALL	*RIGIDWALL	Rigid wall force	RWFORC
SPC	*BOUNDARY_SPC	SPC reaction force	SPCFORC
SPOTWELD	*CONSTRAINED_POINTS	Spot weld force	SWFORC
X-SECTION	*DATABASE_CROSS_SECTION	Joint force	SECFORC

**Table 33.2.** Force transducer type sensor



**\*SENSOR\_DEFINE\_NODE\_{OPTION}**

Available options include:

<BLANK>

**SET**

Purpose: Define an accelerometer type sensor. This command outputs the relative linear acceleration, velocity, or relative coordinate of node-1 with respect to node-2 along vector VID.

Card            1            2            3            4            5            6            7            8

Variable	SENSID	NODE1	NODE2	VID	CRD	CTYPE		
Type	I	I	I	A/I	I	A		

<u>VARIABLE</u>	<u>DESCRIPTION</u>
SENSID	Sensor ID.
NODE1,2	Nodes defining the accelerometer. NODE1 is a node set ID when option <u>_SET</u> is active. In case of option <u>_SET</u> , a positive NODE1 requires all nodes in set NODE1 to meet the switch condition to switch the status of related *SENSOR_SWITCH. If NODE1 is negative, the status of related *SENSOR_SWITCH will be changed if at least one of nodes in set “-NODE1” meets the switch condition.
VID	ID of vector along which the nodal values are measured, see *DEFINE_VECTOR.
CRD	Obsolete (not used).
CTYPE	Output component type: EQ.ACC: acceleration EQ.VEL: velocity EQ.COORD: coordinate

**Remarks:**

The vector direction is determined by \*DEFINE\_VECTOR. This vector direction is updated with time only if the coordinate system CID (see \*DEFINE\_VECTOR) is defined using

## **\*SENSOR**

## **\*SENSOR\_DEFINE\_NODE**

---

\*DEFINE\_COORDINATE\_NODES and the parameter FLAG is set to 1. Otherwise, the vector direction is fixed.

**\*SENSOR\_SWITCH**

Purpose: This command compares the value of a sensor, \*SENSOR\_DEFINE or SENSOR\_CALC-MATH, to a given criterion to check if the switch condition is met. It outputs a logic value of TRUE or FALSE.

Card            1            2            3            4            5            6            7            8

Variable	SWITID	TYPE	SENSID	LOGIC	VALUE	FILTRID	TIMWIN	
Type	I	A	I	A	F	I	F	

**VARIABLE****DESCRIPTION**

SWITID	Switch ID can be referred directly by *SENSOR_CONTROL to control the status of entities like CONTACT and AIRBAG, or can be referred to by *SENSOR_SWITCH_CALC-LOGIC for logic computation.
TYPE	Type: EQ.Sensor: EQ.Time:
SENSID	ID of the sensor whose value will be compared to the criterion to determine if a switch condition is met.
LOGIC	Logic: EQ.LT: less than EQ.GT: greater than
VALUE	Critical value
FILTER	Filter ID (optional). Filters may be defined using *DEFINE_FILTER.
TIMWIN	Trigger a status change when the value given by the sensor is less than or greater than (depending on LOGIC) the VALUE for a duration defined by TIMWIN.

**\*SENSOR\_SWITCH\_CALC-LOGIC**

Purpose: This command performs a logic calculation for the logic output of up to seven \*SENSOR\_SWITCH or \*SENSOR\_SWITCH\_CALC-LOGIC definitions. The output is a logic value of either TRUE or FALSE.

Card            1            2            3            4            5            6            7            8

Variable	SWITID	SWIT1	SWIT2	SWIT3	SWIT4	SWIT5	SWIT6	SWIT7
Type	I	I	I	I	I	I	I	I

**VARIABLE****DESCRIPTION**

SWITID            Switch ID can be referred directly by \*SENSOR\_CONTROL to control the status of entities like CONTACT and AIRBAG, or can be referred to by \*SENSOR\_SWITCH\_CALC-LOGIC for logic computation.

SWITn            Input a positive sensor switch ID for "AND" and negative sensor switch ID for "OR". SWIT1 must always be positive.

To understand how this command returns a value of TRUE or FALSE, think in terms of a simple equation where...

TRUE = 1,  
FALSE = 0,  
AND = multiplication,  
OR = addition

... and the value of the equation cannot exceed 1.

Example:

Let's say there are five previously defined sensor switches with IDs and current values as follows:

SWITID 11 = TRUE  
SWITID 12 = FALSE  
SWITID 13 = TRUE  
SWITID 14 = TRUE  
SWITID 15 = FALSE

To evaluate the expression

(SWITID 11 OR SWITID 12 OR SWITID 13) AND (SWITID 14 OR SWITID 15), and return the value via SWITID 103, the following would work:

\*SENSOR\_SWITCH\_CALC\_LOGIC

101,11,-12,-13

102,14,-15

103,101,102

This translates into

SWITID 101 = (SWITID 11 OR SWITID 12 OR SWITID 13) =  $\min((1 + 0 + 1), 1) = 1$

SWITID 102 = (SWITID 14 OR SWITID 15) =  $\min((1 + 0), 1) = 1$

SWITID 103 = SWITID 101 AND SWITID 102 =  $\min((1 * 1), 1) = 1$

Thus (SWITID 11 OR SWITID 12 OR SWITID 13) AND (SWITID 14 OR SWITID 15)  
returns a value of 1 (or TRUE).



# **\*SET**

The keyword **\*SET** provides a convenient way of defining groups of nodes, parts, elements, and segments. The sets can be used in the definitions of contact interfaces, loading conditions, boundary conditions, and other inputs. Each set type must have a unique numeric identification. The keyword control cards in this section are defined in alphabetical order:

**\*SET\_BEAM\_{OPTION}\_{OPTION}**

**\*SET\_BEAM\_ADD**

**\*SET\_DISCRETE\_{OPTION}\_{OPTION}**

**\*SET\_DISCRETE\_ADD**

**\*SET\_MULTI-MATERIAL\_GROUP\_LIST**

**\*SET\_NODE\_{OPTION}\_{OPTION}**

**\*SET\_NODE\_ADD\_{OPTION}**

**\*SET\_PART\_{OPTION}\_{OPTION}**

**\*SET\_PART\_ADD**

**\*SET\_SEGMENT\_{OPTION}\_{OPTION}**

**\*SET\_2D\_SEGMENT\_{OPTION}\_{OPTION}**

**\*SET\_SHELL\_{OPTION}\_{OPTION}**

**\*SET\_SHELL\_ADD**

**\*SET\_SOLID\_{OPTION}\_{OPTION}**

**\*SET\_SOLID\_ADD**

**\*SET\_TSHELL\_{OPTION}\_{OPTION}**

An additional option **\_TITLE** may be appended to all the **\*SET** keywords. If this option is used then an addition line is read for each section in 80a format which can be used to describe the set. At present LS-DYNA does not make use of the title. Inclusion of titles gives greater clarity to input decks.

## **\*SET**

---

The **GENERAL** option is available for set definitions. In this option, the commands are executed in the order defined. For example, the delete option cannot delete a node or element unless the node or element was previously added via a command such as **BOX** or **ALL**.

The **COLLECT** option allows for the definition of multiple sets that share the same ID and combines them into one large set whenever this option is found. If two or more like sets definitions share the same IDs, they are combined if and only if the **\_COLLECT** option is specified in each definition. If the **\_COLLECT** option is not specified for one or more like set definitions that share identical ID's an error termination will occur. For include files using **\*INCLUDE\_TRANSFORM** where set offsets are specified, the offsets are not applied for the case where the **\_COLLECT** option is present.



**\*SET\_BEAM\_{OPTION}**

Available options include:

**<BLANK>**

**GENERATE**

**GENERAL**

**COLLECT**

The last option, GENERATE, will generate a block of beam element ID's between a starting ID and an ending ID. An arbitrary number of blocks can be specified to define the set.

Purpose: Define a set of beam elements.

Card 1            1            2            3            4            5            6            7            8

Variable	SID								
Type	I								
Default	none								

**Cards 2, 3, 4, ... (OPTION=none) (The next "\*" card terminates the input.)**

Card 2...        1            2            3            4            5            6            7            8

Variable	K1	K2	K3	K4	K5	K6	K7	K8
Type	I	I	I	I	I	I	I	I

# \*SET

\*SET\_BEAM

**Cards 2, 3, 4, ... (OPTION=GENERATE) (The next “\*” card terminates the input.)**

Card 2...      1            2            3            4            5            6            7            8

Variable	B1BEG	B1END	B2BEG	B2END	B3BEG	B3END	B4BEG	B4END
Type	I	I	I	I	I	I	I	I

**Cards 2, 3, 4, ... (OPTION=GENERAL) (The next “\*” card terminates the input.) This set is a combination of a series of options: ALL, ELEM, DELEM, PART, DPART, BOX, and DBOX.**

Card 2...      1            2            3            4            5            6            7            8

Variable	OPTION	E1	E2	E3	E4	E5	E6	E7
Type	A	I	I	I	I	I	I	I

<u>VARIABLE</u>	<u>DESCRIPTION</u>
SID	Set ID
K1	First beam element
K2	Second beam element
.	.
.	.
KNUM	Last beam element
BNBEG	First beam element ID in block N.
BNEND	Last beam element ID in block N. All defined ID's between and including BNBEG to BNEND are added to the set. These sets are generated after all input is read so that gaps in the element numbering are not a problem. BNBEG and BNEND may simply be limits on the ID's and not element ID's.
OPTION	Option for GENERAL. See table below.
E1,...,E7	Specified entity. Each card must have the option specified. See table

**VARIABLE**

**DESCRIPTION**

below.

<b>OPTION</b>	<b>ENTITY (define up to 7)</b>	<b>FUNCTION</b>
ALL		All beam elements will be included in the set.
ELEM	e1, e2, e3, e4, e5, e6, e7	Elements e1, e2, e3, ... will be included.
DELEM	e1, e2, e3, e4, e5, e6, e7	Elements e1, e2, e3, ... previously added will be excluded.
PART	p1, p2, p3, p4, p5, p6, p7	Elements of parts p1, p2, p3, ... will be included.
DPART	p1, p2, p3, p4, p5, p6, p7	Elements of parts p1, p2, p3, ... previously added will be excluded.
BOX	b1, b2, b3, b4, b5, b6, b7	Elements inside boxes b1, b2, ... will be included.
DBOX	b1, b2, b3, b4, b5, b6, b7	Elements inside boxes b1, b2, ... previously added will be excluded.

# \*SET

# \*SET\_BEAM\_ADD

## \*SET\_BEAM\_ADD

Purpose: Define a beam set by combining beam sets.

Card 1            1            2            3            4            5            6            7            8

Variable	SID							
Type	I							
Default	none							

### Card 2, 3, 4 ... (The next "\*" card terminates the input.)

Card 2...        1            2            3            4            5            6            7            8

Variable	BSID1	BSID2	BSID3	BSID4	BSID5	BSID6	BSID7	BSID8
Type	I	I	I	I	I	I	I	I

### VARIABLE

### DESCRIPTION

SID                      Set ID of new beam set. All beam sets should have a unique set ID.

BSIDn                    The nth beam set ID

**\*SET\_BEAM\_INTERSECT**

Purpose: Define a beam set as the intersection,  $\cap$ , of a series of beam sets. The new beam set, SID, contains all common elements of all beam sets BSID<sub>n</sub>.

Card 1            1            2            3            4            5            6            7            8

Variable	SID							
Type	I							
Default	none							

**Card 2, 3, 4 ... (The next “\*” card terminates the input.)**

Card 2...        1            2            3            4            5            6            7            8

Variable	BSID1	BSID2	BSID3	BSID4	BSID5	BSID6	BSID7	BSID8
Type	I	I	I	I	I	I	I	I

<u>VARIABLE</u>	<u>DESCRIPTION</u>
SID	Set ID of new beam set. All beam sets should have a unique set ID.
BSID <sub>n</sub>	The nth beam set ID

# \*SET

# \*SET\_DISCRETE

## \*SET\_DISCRETE\_{OPTION}

Available options include:

<BLANK>

GENERATE

GENERAL

COLLECT

The last option, GENERATE, will generate a block of discrete element ID's between a starting ID and an ending ID. An arbitrary number of blocks can be specified to define the set.

Purpose: Define a set of discrete elements.

Card 1            1            2            3            4            5            6            7            8

Variable	SID							
Type	I							
Default	none							

**Cards 2, 3, 4, ... (OPTION=none) (The next "\*" card terminates the input.)**

Card 2...        1            2            3            4            5            6            7            8

Variable	K1	K2	K3	K4	K5	K6	K7	K8
Type	I	I	I	I	I	I	I	I

**Cards 2, 3, 4, ... (OPTION=GENERATE) (The next “\*” card terminates the input.)**

Card 2...            1            2            3            4            5            6            7            8

Variable	B1BEG	B1END	B2BEG	B2END	B3BEG	B3END	B4BEG	B4END
Type	I	I	I	I	I	I	I	I

**Cards 2, 3, 4, ... (OPTION=GENERAL) (The next “\*” card terminates the input.) This set is a combination of a series of options: ALL, ELEM, DELEM, PART, DPART, BOX, and DBOX.**

Card 2...            1            2            3            4            5            6            7            8

Variable	OPTION	E1	E2	E3	E4	E5	E6	E7
Type	A	I	I	I	I	I	I	I

<u>VARIABLE</u>	<u>DESCRIPTION</u>
SID	Set ID
K1	First discrete element
K2	Second discrete element
.	.
.	.
KNUM	Last discrete element
BNBEG	First discrete element ID in block N.
BNEND	Last discrete element ID in block N. All defined ID's between and including BNBEG to BNEND are added to the set. These sets are generated after all input is read so that gaps in the element numbering are not a problem. BNBEG and BNEND may simply be limits on the ID's and not element ID's.
OPTION	Option for GENERAL. See table below.
E1,...,E7	Specified entity. Each card must have the option specified. See table

**VARIABLE****DESCRIPTION**

below.

<b>OPTION</b>	<b>ENTITY (define up to 7)</b>	<b>FUNCTION</b>
ALL		All discrete elements will be included in the set.
ELEM	e1, e2, e3, e4, e5, e6, e7	Elements e1, e2, e3, ... will be included.
DELEM	e1, e2, e3, e4, e5, e6, e7	Elements e1, e2, e3, ... previously added will be excluded.
PART	p1, p2, p3, p4, p5, p6, p7	Elements of parts p1, p2, p3, ... will be included.
DPART	p1, p2, p3, p4, p5, p6, p7	Elements of parts p1, p2, p3, ... previously added will be excluded.
BOX	b1, b2, b3, b4, b5, b6, b7	Elements inside boxes b1, b2, ... will be included.
DBOX	b1, b2, b3, b4, b5, b6, b7	Elements inside boxes b1, b2, ... previously added will be excluded.



**\*SET\_DISCRETE\_ADD**

Purpose: Define a discrete set by combining discrete sets.

Card 1            1            2            3            4            5            6            7            8

Variable	SID								
Type	I								
Default	None								

**Card 2, 3, 4 ... (The next "\*" card terminates the input.)**

Card 2...        1            2            3            4            5            6            7            8

Variable	DSID1	DSID2	DSID3	DSID4	DSID5	DSID6	DSID7	DSID8
Type	I	I	I	I	I	I	I	I

<u>VARIABLE</u>	<u>DESCRIPTION</u>
SID	Set ID of new beam set. All beam sets should have a unique set ID.
DSIDn	The nth discrete set ID

# \*SET

## \*SET\_MULTI-MATERIAL\_GROUP\_LIST

### \*SET\_MULTI-MATERIAL\_GROUP\_LIST

Purpose: This command defines an ALE multi-material set ID (AMMSID) which contains a collection of one or more ALE multi-material group ID(s) (AMMGID). This provides a means for selecting any specific ALE multi-material(s). Application includes, for example, a selection of any particular fluid(s) to be coupled to a fluid-structure interaction.

Card 1            1            2            3            4            5            6            7            8

Variable	AMSID							
Type	I							
Default	0							

Card 2            1            2            3            4            5            6            7            8

Variable	AMGID1	AMGID2	AMGID3	AMGID4	AMGID5	AMGID6	AMGID7	AMGID8
Type	I	I	I	I	I	I	I	I
Default	0	0	0	0	0	0	0	0

#### VARIABLE

#### DESCRIPTION

AMSID	An ALE multi-material set ID (AMSID) which contains a collection of one or more ALE multi-material group ID(s) (AMMGID).
AMGID1	The 1st ALE multi-material group ID (AMGID=1) defined by the 1st data line of the *ALE_MULTI-MATERIAL_GROUP card.
...	...
AMGID8	The 8th ALE multi-material group ID (AMGID=8) defined by the 8th data line of the *ALE_MULTI-MATERIAL_GROUP card.

**Remarks:**

1. Refer to an example in the \*CONSTRAINED\_LAGRANGE\_IN\_SOLID section.

# \*SET

# \*SET\_NODE

\*SET\_NODE\_{OPTION}

Available options include:

<BLANK>

LIST

COLUMN

LIST\_GENERATE

GENERAL

COLLECT

The option, LIST\_GENERATE, will generate a block of node ID's between a starting nodal ID number and an ending nodal ID number. An arbitrary number of blocks can be specified to define the set.

Purpose: Define a nodal set with some identical or unique attributes.

Card 1            1            2            3            4            5            6            7            8

Variable	SID	DA1	DA2	DA3	DA4	SOLVER		
Type	I	F	F	F	F	A		
Default	none	0.	0.	0.	0.	MECH		
Remark		1	1	1	1	3		

**Cards 2, 3, 4, ... (OPTION=LIST or <BLANK>) (The next "\*" card terminates the input.)**

Card 2...        1            2            3            4            5            6            7            8

Variable	NID1	NID2	NID3	NID4	NID5	NID6	NID7	NID8
Type	I	I	I	I	I	I	I	I

**Cards 2, 3, 4, ... (OPTION=COLUMN) (The next “\*” card terminates the input.)**

Card 2...	1	2	3	4	5	6	7	8
Variable	NID	A1	A2	A3	A4			
Type	I	F	F	F	F			
Remark		2	2	2	2			

**Cards 2, 3, 4, ... (OPTION=LIST\_GENERATE) (The next “\*” card terminates the input.)**

Card 2...	1	2	3	4	5	6	7	8
Variable	B1BEG	B1END	B2BEG	B2END	B3BEG	B3END	B4BEG	B4END
Type	I	I	I	I	I	I	I	I

**Cards 2, 3, 4, ... (OPTION=GENERAL) (The next “\*” card terminates the input.) This set is a combination of a series of options: ALL, NODE, DNODE, PART, DPART, BOX, and DBOX.**

Card 2...	1	2	3	4	5	6	7	8
Variable	OPTION	E1	E2	E3	E4	E5	E6	E7
Type	A	I	I	I	I	I	I	I

**VARIABLE**

**DESCRIPTION**

SID	Set identification. All node sets should have a unique set ID.
DA1	First nodal attribute default value, see remark 1 below.
DA2	Second nodal attribute default value
DA3	Third nodal attribute default value
DA4	Fourth nodal attribute default value

<b>VARIABLE</b>	<b>DESCRIPTION</b>
NIDn	Node ID n
NID	Nodal ID
A1	First nodal attribute, see remark 2 below.
A2	Second nodal attribute
A3	Third nodal attribute
A4	Fourth nodal attribute
BNBEG	First node ID in block N.
BNEND	Last node ID in block N. All defined ID's between and including BNBEG to BNEND are added to the set. These sets are generated after all input is read so that gaps in the node numbering are not a problem. BNBEG and BNEND may simply be limits on the ID's and not nodal ID's.
OPTION	Option for GENERAL. See table below.
E1,...,E7	Specified entity. Each card must have the option specified. See table below.

<b>OPTION</b>	<b>ENTITY (define up to 7)</b>	<b>FUNCTION</b>
ALL		All nodes will be included in the set.
NODE	n1, n2, n3, n4, n5, n6, n7	Nodes n1~n7 will be included.
DNODE	n1, n2, n3, n4, n5, n6, n7	Nodes n1~n7 previously added will be excluded.
PART	p1, p2, p3, p4, p5, p6, p7	Nodes of parts p1~p7 will be included.
DPART	p1, p2, p3, p4, p5, p6, p7	Nodes of parts p1~p7 previously added will be excluded.
BOX	b1, b2, b3, b4, b5, b6, b7	Nodes inside boxes b1~b7 will be included.
DBOX	b1, b2, b3, b4, b5, b6, b7	Nodes inside boxes b1~b7 previously added will be excluded.

<b>OPTION</b>	<b>ENTITY (define up to 7)</b>	<b>FUNCTION</b>
VOL	v1, v2, v3, v4, v5, v6, v7	Nodes inside contact volumes vi~v7 previously added will be included.
DVOL	v1, v2, v3, v4, v5, v6, v7	Nodes inside contact volumes vi~v7 previously added will be excluded.

**Remarks:**

1. Nodal attributes can be assigned for some input types. For example, for contact option, \*CONTACT\_TIEBREAK\_NODES\_TO\_SURFACE the attributes are:  
DA1=NFLF    Normal failure force,  
DA2=NSFLF    Shear failure force,  
DA3=NNEN    Exponent for normal force,  
DA4=NMES    Exponent for shear force.
2. The default nodal attributes can be overridden on these cards; otherwise, A1=DA1, etc.
3. This field is used by a non-mechanics solver to create a set defined on that solver's mesh. By default, the set refers to the mechanics mesh.

# \*SET

# \*SET\_NODE\_ADD

\*SET\_NODE\_ADD\_{OPTION}

Available options include:

<BLANK>

**ADVANCED**

Purpose: Define a node set by combining node sets or for the ADVANCED option by combining, NODE, SHELL, SOLID, BEAM, SEGMENT, DISCRETE and THICK SHELL sets.

Card 1            1            2            3            4            5            6            7            8

Variable	NSID	A1	A2	A3	A4	SOLVER		
Type	I	F	F	F	F	A		
Default	none	none	none	none	none	MECH		
Remark						1		

**If the ADVANCED option is inactive:**

**Card 2, 3, 4, ... (The next "\*" card terminates the input.)**

Card 2...        1            2            3            4            5            6            7            8

Variable	NSID1	NSID2	NSID3	NSID4	NSID5	NSID6	NSID7	NSID8
Type	I	I	I	I	I	I	I	I



If the **ADVANCED** option is active:

Card 2, 3, 4 ... (The next “\*” card terminates the input.)

Card 2...            1            2            3            4            5            6            7            8

Variable	SID1	TYPE1	SID2	TYPE2	SID3	TYPE3	SID4	TYPE4
Type	I	I	I	I	I	I	I	I

<u>VARIABLE</u>	<u>DESCRIPTION</u>
NSID	Set ID of new node set. All node sets should have a unique set ID.
BSIDn	The nth node set ID
SIDn	The nth set ID
TYPE <sub>n</sub>	Type set for SID <sub>n</sub> : 1: - Node set 2: - Shell set 3: - Beam set 4: - Solid set 5: - Segment set 6: - Discrete set 7: - Thick shell set

**Remarks:**

1. This field is used by a non-mechanics solver to create a set defined on that solver’s mesh. By default, the set refers to the mechanics mesh.

# \*SET

# \*SET\_NODE\_INTERSECT

## \*SET\_NODE\_INTERSECT

Purpose: Define a node set as the intersection,  $\cap$ , of a series of node sets. The new node set, NSID, contains all common elements of all node sets NSID<sub>n</sub>.

Card 1            1            2            3            4            5            6            7            8

Variable	NSID	DA1	DA2	DA3	DA4			
Type	I	F	F	F	F			
Default	none	none	none	none	none			

**Card 2, 3, 4 ... (The next “\*” card terminates the input.)**

Card 2...        1            2            3            4            5            6            7            8

Variable	NSID1	NSID2	NSID3	NSID4	NSID5	NSID6	NSID7	NSID8
Type	I	I	I	I	I	I	I	I

### VARIABLE

### DESCRIPTION

SID	Set ID of new node set. All node sets should have a unique set ID.
DA <sub>i</sub>	Nodal attribute of the i'th node.
NSID <sub>n</sub>	The nth node set ID.

**\*SET\_PART\_{OPTION}**

Available options include:

**<BLANK>**

**LIST**

**COLUMN**

**LIST\_GENERATE**

**COLLECT**

The last option will generate a block of part ID's between a starting part ID number and an ending part ID number. An arbitrary number of blocks can be specified to define the part set.

Purpose: Define a set of parts with optional attributes. For the column option, see \*AIRBAG or \*CONSTRAINED\_RIGID\_BODY\_STOPPERS.

Card 1            1            2            3            4            5            6            7            8

Variable	SID	DA1	DA2	DA3	DA4	SOLVER		
Type	I	F	F	F	F	A		
Default	none	0.				MECH		
Remark		1	1	1	1	3		

**Card 2, 3, 4, ... (OPTION=LIST or <BLANK>) (The next "\*" card terminates the input.)**

Card 2...        1            2            3            4            5            6            7            8

Variable	PID1	PID2	PID3	PID4	PID5	PID6	PID7	PID8
Type	I	I	I	I	I	I	I	I

**Card 2, 3, 4, ... (OPTION=COLUMN) (The next “\*” card terminates the input.)**

Card 2...            1            2            3            4            5            6            7            8

Variable	PID	A1	A2	A3	A4			
Type	I	F	F	F	F			
Remark		2	2	2	2			

**Cards 2, 3, 4, ... (OPTION=LIST\_GENERATE) (The next “\*” card terminates the input.)**

Card 2...            1            2            3            4            5            6            7            8

Variable	B1BEG	B1END	B2BEG	B2END	B3BEG	B3END	B4BEG	B4END
Type	I	I	I	I	I	I	I	I

<u>VARIABLE</u>	<u>DESCRIPTION</u>
SID	Set ID. All part sets should have a unique set ID.
DA1	First attribute default value, see remark 1 below.
DA2	Second attribute default value
DA3	Third attribute default value
DA4	Fourth attribute default value
PID	Part ID
PID1	First part ID
PID2	Second part ID
.	.
A1	First part attribute, see remark 2 below.
A2	Second part attribute
A3	Third part attribute

---

<u>VARIABLE</u>	<u>DESCRIPTION</u>
A4	Fourth part attribute
BNBEG	First part ID in block N.
BNEND	Last part ID in block N. All defined ID's between and including BNBEG to BNEND are added to the set. These sets are generated after all input is read so that gaps in the part numbering are not a problem. BNBEG and BNEND may simply be limits on the ID's and not part ID's.

**Remarks:**

1. Part attributes can be assigned for some input types. For example, for airbags a time delay, DA1=T1, can be defined before pressure begins to act along with a time delay, DA2=T2, before full pressure is applied, (default T2=T1), and for the constraint option, \*CONSTRAINED\_RIGID\_BODY\_STOPPERS one attribute can be defined: DA1, the closure distance which activates the stopper constraint.
2. The default part attributes can be overridden on the part cards; otherwise, A1=DA1, etc.
3. This field is used by a non-mechanics solver to create a set defined on that solver's mesh. By default, the set refers to the mechanics mesh.

# \*SET

## \*SET\_PART\_ADD

### \*SET\_PART\_ADD

Purpose: Define a part set by combining part sets. The attributes, if any, (see \*SET\_PART above) will be taken from the part sets that are combined.

Card 1            1            2            3            4            5            6            7            8

Variable	SID	SOLVER						
Type	I	A						
Default	none	MECH						
Remark		1						

**Card 2, 3, 4, ... (The next “\*” card terminates the input.)**

Card 2...        1            2            3            4            5            6            7            8

Variable	PSID1	PSID2	PSID3	PSID4	PSID5	PSID6	PSID7	PSID8
Type	I	I	I	I	I	I	I	I

#### VARIABLE

#### DESCRIPTION

SID

Set ID. All part sets should have a unique set ID.

PSIDn

The nth part set ID

>0: PSIDn is added to SID,

<.0: all part sets with ID between PSID<sub>(i-1)</sub> and |PSID<sub>i</sub>|, including PSID<sub>(i-1)</sub> and |PSID<sub>i</sub>|, will be added to SID. PSID<sub>(i-1)</sub> has to be >0 and has a magnitude smaller or equal to |PSID<sub>i</sub>| when PSID<sub>i</sub><.0.

#### Remarks:

1. This field is used by a non-mechanics solver to create a set defined on that solver's mesh. By default, the set refers to the mechanics mesh.

**\*SET\_SEGMENT\_{OPTION}**

Available options include:

**<BLANK>**

**GENERAL**

**COLLECT**

Purpose: Define a set of quadrilateral and triangular segments with optional identical or unique attributes.

Card 1            1            2            3            4            5            6            7            8

Variable	SID	DA1	DA2	DA3	DA4	SOLVER		
Type	I	F	F	F	F	A		
Default	none	0.	0.	0.	0.	MECH		
Remarks		1	1	1	1	4		

**Cards 2, 3, 4, ... (No option is specified) (The next “\*” card terminates the input.)**

Card 2...        1            2            3            4            5            6            7            8

Variable	N1	N2	N3	N4	A1	A2	A3	A4
Type	I	I	I	I	F	F	F	F
Remarks				2	3	3	3	3

**Cards 2, 3, 4, ... (OPTION=GENERAL) (The next “\*” card terminates the input.) This set is a combination of a series of options listed in the table defined below.**

Card 2...	1	2	3	4	5	6	7	8
Variable	OPTION	E1	E2	E3	E4	E5	E6	E7
Type	A	I	I	I	I or F	I or F	I or F	I or F

**VARIABLE****DESCRIPTION**

SID	Set ID. All segment sets should have a unique set ID.
DA1	First segment attribute default value, see remark 1 below.
DA2	Second segment attribute default value
DA3	Third segment attribute default value
DA4	Fourth segment attribute default value
N1	Nodal point $n_1$
N2	Nodal point $n_2$
N3	Nodal point $n_3$
N4	Nodal point $n_4$ , see remark 2 below.
A1	First segment attribute, see remark 3 below.
A2	Second segment attribute
A3	Third segment attribute
A4	Fourth segment attribute
NFLS	Normal failure stress
SFLS	Shear failure stress. Failure criterion:
OPTION	Option for GENERAL. See table below.
E1,...,E7	Specified entity. Each card must have an option specified. See table below.



OPTION	ENTITIES + ATTRIBUTES	FUNCTION
FORMAT A10	FORMAT 3I10	FORMAT 4F10.0
BOX	b1, b2, b3, a1, a2, a3, a4	Generate segments inside box ID bi, i=1~3. For shell elements one segment per shell is generated. For solid elements only those segments wrapping the solid part and pointing outward from the part will be generated.
BOX_SHELL	b1, b2, b3, a1, a2, a3, a4	Generate segments inside box ID bi, i=1~3. The segments are only generated for shell elements. One segment per shell is generated.
BOX_SLDIO	b1, b2, b3, a1, a2, a3, a4	Generate segments inside box ID bi, i=1~3. Both exterior segments and inter-element segments are generated.
BOX_SOLID	b1, b2, b3, a1, a2, a3, a4	Generate segments inside box ID bi, i=1~3. The segments are only generated for exterior solid elements
PART	p1, p2, p3, a1, a2, a3, a4	Generate segments of parts p1, p2, p3 with attributes a1~a4. For shell elements one segment per shell is generated. For solid elements only those segments wrapping the solid part and pointing outward from the part will be generated.
PART_IO	p1, p2, p3, a1, a2, a3, a4	Generate segments of parts p1, p2, p3 with attributes a1~a4. Same as the PART option above except that inter-element segments inside parts will be generated as well. This option is sometimes useful for single surface contact of solid elements to prevent negative volumes.
SEG	n1, n2, n3, n4	Create segment with node ID's n1, n2, n3, and n4.
VOL	v1, v2, v3, a1, a2, a3, a4	Generate segments inside contact volume ID vi, i=1~3. See BOX option for other details
VOL_SHELL	v1, v2, v3, a1, a2, a3, a4	Generate segments for shell elements inside contact volume ID vi, i=1~3.

<b>OPTION</b>	<b>ENTITIES + ATTRIBUTES</b>	<b>FUNCTION</b>
VOL_SLDIO	v1, v2, v3, a1, a2, a3, a4	Generate segments for solid elements inside contact volume ID vi, i=1~3. See BOX_SLDIO for other details.
VOL_SOLID	v1, v2, v3, a1, a2, a3, a4	Generate segments for solid elements inside contact volume ID vi, i=1~3. See BOX_SOLID for other details..
DBOX	b1, b2, b3, b4, b5, b6, b7	Segments inside boxes bi, i=1~7, will be excluded.
DBOX_SHELL	b1, b2, b3, b4, b5, b6, b7	Shell related segments inside boxes bi, i=1~7, will be excluded.
DBOX_SOLID	b1, b2, b3, b4, b5, b6, b7	Solid related segments inside boxes bi, i=1~7, will be excluded.
DPART	p1, p2, p3, p4, p5, p6, p7	Segments of parts pi, i=1~7, will be excluded
DSEG	n1, n2, n3, n4	Segment with node ID's n1,n2, n3, and n4 will be deleted
DVOL	v1, v2, v3, v4, v5, v6, v7	Segments inside contact volumes vi, i=1~7, will be excluded.
DVOL_SHELL	v1, v2, v3, v4, v5, v6, v7	Shell related segments inside contact volumes vi, i=1~7, will be excluded.
DVOL_SOLID	v1, v2, v3, v4, v5, v6, v7	Solid related segments inside contact volumes vi, i=1~7, will be excluded.

**Remarks:**

- Segment attributes can be assigned for some input types. For example, for the contact options, the attributes for the SLAVE surface are:

DA1=NFLS Normal failure stress, \*CONTACT\_TIEBREAK\_SURFACE\_contact only,

DA2=SFLS Shear failure stress, \*CONTACT\_TIEBREAK\_SURFACE\_contact only,

DA3=FSF Coulomb friction scale factor,

DA4=VSF Viscous friction scale factor,

and the attributes for the MASTER surface are:

DA1=FSF      Coulomb friction scale factor,

DA2=VSF      Viscous friction scale factor.

For airbags, see \*AIRBAG, a time delay, DA1=T1, can be defined before pressure begins to act on a segment along with a time delay, DA2=T2, before full pressure is applied to the segment, (default T2=T1), and for the constraint option,

2. To define a triangular segment make  $n_4$  equal to  $n_3$ .
3. The default segment attributes can be overridden on these cards, otherwise, A1=DA1, etc.
4. This field is used by a non-mechanics solver to create a set defined on that solver's mesh. By default, the set refers to the mechanics mesh.

# \*SET

## \*SET\_SEGMENT\_ADD

### \*SET\_SEGMENT\_ADD

Purpose: Define a segment set by combining segment sets.

Card 1            1            2            3            4            5            6            7            8

Variable	SID							
Type	I							
Default	none							

### Card 2, 3, 4 ... (The next "\*" card terminates the input.)

Card 2...        1            2            3            4            5            6            7            8

Variable	SSID1	SSID2	SSID3	SSID4	SSID5	SSID6	SSID7	SSID8
Type	I	I	I	I	I	I	I	I

#### VARIABLE

#### DESCRIPTION

SID                      Set ID of new segment set. All segment sets should have a unique set ID.

BSIDn                    The nth segment set ID

**\*SET\_SEGMENT\_INTERSECT**

Purpose: Define a segment set as the intersection,  $\cap$ , of a series of segment sets. The new segment set, SID, contains all common segments of all segment sets SSIDn.

Card 1            1            2            3            4            5            6            7            8

Variable	SID								
Type	I								
Default	none								

**Card 2, 3, 4 ... (The next “\*” card terminates the input.)**

Card 2...        1            2            3            4            5            6            7            8

Variable	SSID1	SSID2	SSID3	SSID4	SSID5	SSID6	SSID7	SSID8
Type	I	I	I	I	I	I	I	I

<u>VARIABLE</u>	<u>DESCRIPTION</u>
SID	Set ID of new segment set. All segment sets should have a unique set ID.
SSIDn	The nth segment set ID

# \*SET

# \*SET\_2D\_SEGMENT

## \*SET\_2D\_SEGMENT\_{OPTION}

Available options include:

<BLANK>

SET

COLLECT

Purpose: Define a set of boundary line segments in two dimensional axisymmetric, plane stress, and plane strain geometries with optional identical or unique attributes. This option is recommended for thermal problems which involve adaptivity.

Card 1            1            2            3            4            5            6            7            8

Variable	SID	DA1	DA2	DA3	DA4			
Type	I	F	F	F	F			
Default	none	0.	0.	0.	0.			
Remarks		1	1	1	1			

Card 2            1            2            3            4            5            6            7            8

Variable	PID/PSID							
Type	I							
Remarks	2							

### VARIABLE

### DESCRIPTION

SID            Set ID. All segment sets should have a unique set ID.

DA1            First segment attribute default value, see remark 1 below.

DA2            Second segment attribute default value

---

<u>VARIABLE</u>	<u>DESCRIPTION</u>
DA3	Third segment attribute default value
DA4	Fourth segment attribute default value
PID/PSID	Part ID or part set ID if SET option is specified.

**Remarks:**

1. The boundary along  $r = 0$  isn't included in axisymmetric problems.
2. The common boundary between parts isn't included in the boundary segments.

**\*SET\_SHELL\_{OPTION}**

Available options include:

&lt;BLANK&gt;

**LIST****COLUMN****LIST\_GENERATE****GENERAL****COLLECT**

The last option will generate a block of shell ID's between a starting shell ID number and an ending ID number. An arbitrary number of blocks can be specified to define the shell set.

Purpose: Define a set of shell elements with optional identical or unique attributes.

Card 1            1            2            3            4            5            6            7            8

Variable	SID	DA1	DA2	DA3	DA4			
Type	I	F	F	F	F			
Default	none	0.	0.	0.	0.			
Remarks		1	1	1	1			

**Card 2, 3, 4, ... (OPTION=LIST or <BLANK>) (The next "\*" card terminates the input.)**

Card 2...        1            2            3            4            5            6            7            8

Variable	EID1	EID2	EID3	EID4	EID5	EID6	EID7	EID8
Type	I	I	I	I	I	I	I	I
Remarks	2	2	2	2	2	2	2	2



**Card 2, 3, 4, ... (OPTION=COLUMN) (The next “\*” card terminates the input.)**

Card 2...            1            2            3            4            5            6            7            8

Variable	EID	A1	A2	A3	A4			
Type	I	F	F	F	F			
Remarks		3	3	3	3			

**Cards 2, 3, 4, ... (OPTION=LIST\_GENERATE) (The next “\*” card terminates the input.)**

Card 2...            1            2            3            4            5            6            7            8

Variable	B1BEG	B1END	B2BEG	B2END	B3BEG	B3END	B4BEG	B4END
Type	I	I	I	I	I	I	I	I

**Cards 2, 3, 4, ... (OPTION=GENERAL) (The next “\*” card terminates the input.) This set is a combination of a series of options: ALL, ELEM, DELEM, PART, DPART, BOX, and DBOX.**

Card 2...            1            2            3            4            5            6            7            8

Variable	OPTION	E1	E2	E3	E4	E5	E6	E7
Type	A	I	I	I	I	I	I	I

<u>VARIABLE</u>	<u>DESCRIPTION</u>
SID	Set ID. All shell sets should have a unique set ID.
DA1	First attribute default value, see remark 1.
DA2	Second attribute default value
DA3	Third attribute default value
DA4	Fourth attribute default value

<b>VARIABLE</b>	<b>DESCRIPTION</b>
EID1	First shell element ID, see remark 2.
EID2	Second shell element ID
.	.
.	.
EID	Element ID
A1	First attribute
A2	Second attribute
A3	Third attribute
A4	Fourth attribute
BNBEG	First shell ID in shell block N.
BNEND	Last shell ID in block N. All defined ID's between and including BNBEG to BNEND are added to the set. These sets are generated after all input is read so that gaps in the element numbering are not a problem. BNBEG and BNEND may simply be limits on the ID's and not element ID's.
OPTION	Option for GENERAL. See table below.
E1,...,E7	Specified entity. Each card must have the option specified. See table below.

<b>OPTION</b>	<b>ENTITY (define up to 7)</b>	<b>FUNCTION</b>
ALL		All shell elements will be included in the set.
ELEM	e1, e2, e3, e4, e5, e6, e7	Elements e1, e2, e3, ... will be included.
DELEM	e1, e2, e3, e4, e5, e6, e7	Elements e1, e2, e3, ... previously added will be excluded.
PART	p1, p2, p3, p4, p5, p6, p7	Elements of parts p1, p2, p3, ... will be included.
DPART	p1, p2, p3, p4, p5, p6, p7	Elements of parts p1, p2, p3, ... previously added will be excluded.

<b>OPTION</b>	<b>ENTITY (define up to 7)</b>	<b>FUNCTION</b>
BOX	b1, b2, b3, b4, b5, b6, b7	Elements inside boxes b1, b2, ... will be included.
DBOX	b1, b2, b3, b4, b5, b6, b7	Elements inside boxes b1, b2, ... previously added will be excluded.

**Remarks:**

1. Shell attributes can be assigned for some input types. For example, for the contact options, the attributes for the SLAVE surface are:

DA1=NFLS      Normal failure stress, \*CONTACT\_TIEBREAK\_SURFACE\_contact only,

DA2=SFLS      Shear failure stress, \*CONTACT\_TIEBREAK\_SURFACE\_contact only,

DA3=FSF      Coulomb friction scale factor,

DA4=VSF      Viscous friction scale factor,

and the attributes for the MASTER surface are:

DA1=FSF      Coulomb friction scale factor,

DA2=VSF      Viscous friction scale factor.

2. The default attributes are taken.
3. The default shell attributes can be overridden on these cards; otherwise, A1=DA1, etc.

# \*SET

# \*SET\_SHELL\_ADD

## \*SET\_SHELL\_ADD

Purpose: Define a shell set by combining shell sets.

Card 1            1            2            3            4            5            6            7            8

Variable	SID							
Type	I							
Default	none							

### Card 2, 3, 4 ... (The next "\*" card terminates the input.)

Card 2...        1            2            3            4            5            6            7            8

Variable	SSID1	SSID2	SSID3	SSID4	SSID5	SSID6	SSID7	SSID8
Type	I	I	I	I	I	I	I	I

### VARIABLE

### DESCRIPTION

SID                      Set ID of new shell set. All shell sets should have a unique set ID.

BSIDn                    The nth shell set ID

**\*SET\_SHELL\_INTERSECT**

Purpose: Define a shell set as the intersection,  $\cap$ , of a series of shell sets. The new shell set, SID, contains all common elements of all shell sets SSIDn.

Card 1            1            2            3            4            5            6            7            8

Variable	SID							
Type	I							
Default	none							

**Card 2, 3, 4 ... (The next “\*” card terminates the input.)**

Card 2...        1            2            3            4            5            6            7            8

Variable	SSID1	SSID2	SSID3	SSID4	SSID5	SSID6	SSID7	SSID8
Type	I	I	I	I	I	I	I	I

<u>VARIABLE</u>	<u>DESCRIPTION</u>
SID	Set ID of new shell set. All shell sets should have a unique set ID.
SSIDn	The nth shell set ID

# \*SET

\*SET\_SOLID

\*SET\_SOLID\_{OPTION}

Available options include:

<BLANK>

GENERATE

GENERAL

COLLECT

The GENERATE option will generate a block of solid element ID's between a starting ID and an ending ID. An arbitrary number of blocks can be specified to define the set.

Purpose: Define a set of solid elements.

Card 1            1            2            3            4            5            6            7            8

Variable	SID	SOLVER						
Type	I	A						
Default	none	MECH						
Remark		1						

**Cards 2, 3, 4, ... (OPTION=none) (The next "\*" card terminates the input.)**

Card 2...        1            2            3            4            5            6            7            8

Variable	K1	K2	K3	K4	K5	K6	K7	K8
Type	I	I	I	I	I	I	I	I

**Cards 2, 3, 4, ... (OPTION=GENERATE) (The next “\*” card terminates the input.)**

Card 2...            1            2            3            4            5            6            7            8

Variable	B1BEG	B1END	B2BEG	B2END	B3BEG	B3END	B4BEG	B4END
Type	I	I	I	I	I	I	I	I

**Cards 2, 3, 4, ... (OPTION=GENERAL) (The next “\*” card terminates the input.) This set is a combination of a series of options: ALL, ELEM, DELEM, PART, DPART, BOX, and DBOX.**

Card 2...            1            2            3            4            5            6            7            8

Variable	OPTION	E1	E2	E3	E4	E5	E6	E7
Type	A	I	I	I	I	I	I	I

<u>VARIABLE</u>	<u>DESCRIPTION</u>
SID	Set ID. All solid sets should have a unique set ID.
K1	First element ID
K2	Second element ID
.	.
.	.
K8	Eighth element ID
BNBEG	First solid element ID in block N.
BNEND	Last solid element ID in block N. All defined ID's between and including BNBEG to BNEND are added to the set. These sets are generated after all input is read so that gaps in the element numbering are not a problem. BNBEG and BNEND may simply be limits on the ID's and not element ID's.
OPTION	Option for GENERAL. See table below.

**VARIABLE****DESCRIPTION**

E1,...,E7

Specified entity. Each card must have the option specified. See table below.

<b>OPTION</b>	<b>ENTITY (define up to 7)</b>	<b>FUNCTION</b>
ALL		All solid elements will be included in the set.
ELEM	e1, e2, e3, e4, e5, e6, e7	Elements e1, e2, e3, ... will be included.
DELEM	e1, e2, e3, e4, e5, e6, e7	Elements e1, e2, e3, ... previously added will be excluded.
PART	p1, p2, p3, p4, p5, p6, p7	Elements of parts p1, p2, p3, ... will be included.
DPART	p1, p2, p3, p4, p5, p6, p7	Elements of parts p1, p2, p3, ...previously added will be excluded.
BOX	b1, b2, b3, b4, b5, b6, b7	Elements inside boxes b1, b2, ... will be included.
DBOX	b1, b2, b3, b4, b5, b6, b7	Elements inside boxes b1, b2, ... previously added will be excluded.

**Remarks:**

1. This field is used by a non-mechanics solver to create a set defined on that solver's mesh. By default, the set refers to the mechanics mesh.



**\*SET\_SOLID\_ADD**

Purpose: Define a solid set by combining solid sets.

Card 1            1            2            3            4            5            6            7            8

Variable	SID	SOLVER						
Type	I	A						
Default	none	MECH						
Remark		1						

**Card 2, 3, 4 ... (The next “\*” card terminates the input.)**

Card 2...        1            2            3            4            5            6            7            8

Variable	SSID1	SSID2	SSID3	SSID4	SSID5	SSID6	SSID7	SSID8
Type	I	I	I	I	I	I	I	I

**VARIABLE****DESCRIPTION**

SID                      Set ID of new solid set. All solid sets should have a unique set ID.

SSIDn                    The nth solid set ID.

**Remarks:**

1. This field is used by a non-mechanics solver to create a set defined on that solver's mesh. By default, the set refers to the mechanics mesh.

# \*SET

# \*SET\_SOLID\_INTERSECT

## \*SET\_SOLID\_INTERSECT

Purpose: Define a solid set as the intersection,  $\cap$ , of a series of solid sets. The new solid set, SID, contains all common elements of all solid sets SSID<sub>n</sub>.

Card 1            1            2            3            4            5            6            7            8

Variable	SID							
Type	I							
Default	none							

**Card 2, 3, 4 ... (The next “\*” card terminates the input.)**

Card 2...        1            2            3            4            5            6            7            8

Variable	SSID1	SSID2	SSID3	SSID4	SSID5	SSID6	SSID7	SSID8
Type	I	I	I	I	I	I	I	I

### VARIABLE

### DESCRIPTION

SID	Set ID of new solid set. All solid sets should have a unique set ID.
SSID <sub>n</sub>	The nth solid set ID

**\*SET\_TSHELL\_{OPTION}**

Available options include:

**<BLANK>**

**GENERATE**

**GENERAL**

**COLLECT**

The last option, GENERATE, will generate a block of thick shell element ID's between a starting ID and an ending ID. An arbitrary number of blocks can be specified to define the set.

Purpose: Define a set of thick shell elements.

Card 1            1            2            3            4            5            6            7            8

Variable	SID								
Type	I								
Default	none								

**Cards 2, 3, 4, ... (OPTION=none) (The next "\*" card terminates the input.)**

Card 2...        1            2            3            4            5            6            7            8

Variable	K1	K2	K3	K4	K5	K6	K7	K8
Type	I	I	I	I	I	I	I	I

# \*SET

\*SET\_TSHELL

**Cards 2, 3, 4, ... (OPTION=GENERATE) (The next "\*" card terminates the input.)**

Card 2...      1            2            3            4            5            6            7            8

Variable	B1BEG	B1END	B2BEG	B2END	B3BEG	B3END	B4BEG	B4END
Type	I	I	I	I	I	I	I	I

**Cards 2, 3, 4, ... (OPTION=GENERAL) (The next "\*" card terminates the input.) This set is a combination of a series of options: ALL, ELEM, DELEM, PART, DPART, BOX, and DBOX.**

Card 2...      1            2            3            4            5            6            7            8

Variable	OPTION	E1	E2	E3	E4	E5	E6	E7
Type	A	I	I	I	I	I	I	I

## VARIABLE

## DESCRIPTION

SID	Set ID. All tshell sets should have a unique set ID.
K1	First thick shell element ID
K2	Second thick shell element ID
.	.
.	.
K8	Eighth thick shell element ID
.	.
.	.
BNBEG	First thick shell element ID in block N.
BNEND	Last thick shell element ID in block N. All defined ID's between and including BNBEG to BNEND are added to the set. These sets are generated after all input is read so that gaps in the element numbering are not a problem. BNBEG and BNEND may simply be limits on the ID's and not element ID's.

<u>VARIABLE</u>	<u>DESCRIPTION</u>
OPTION	Option for GENERAL. See table below.
E1,...,E7	Specified entity. Each card must have the option specified. See table below.

<b>OPTION</b>	<b>ENTITY (define up to 7)</b>	<b>FUNCTION</b>
ALL		All thick shell elements will be included in the set.
ELEM	e1, e2, e3, e4, e5, e6, e7	Elements e1, e2, e3, ... will be included.
DELEM	e1, e2, e3, e4, e5, e6, e7	Elements e1, e2, e3, ... previously added will be excluded.
PART	p1, p2, p3, p4, p5, p6, p7	Elements of parts p1, p2, p3, ... will be included.
DPART	p1, p2, p3, p4, p5, p6, p7	Elements of parts p1, p2, p3, ... previously added will be excluded.
BOX	b1, b2, b3, b4, b5, b6, b7	Elements inside boxes b1, b2, ... will be included.
DBOX	b1, b2, b3, b4, b5, b6, b7	Elements inside boxes b1, b2, ... previously added will be excluded.



# **\*TERMINATION**

The keyword \*TERMINATION provides an alternative way of stopping the calculation before the termination time is reached. The termination time is specified on the \*CONTROL\_TERMINATION input and will terminate the calculation whether or not the options available in this section are active. Different types of termination may be defined:

# \*TERMINATION

## \*TERMINATION\_BODY

### \*TERMINATION\_BODY

Purpose: Terminate calculation based on rigid body displacements. For \*TERMINATION\_BODY the analysis terminates when the center of mass displacement of the rigid body specified reaches either the maximum or minimum value (stops 1, 2 or 3) or the displacement magnitude of the center of mass is exceeded (stop 4). If more than one condition is input, the analysis stops when any of the conditions is satisfied. Termination by other means than \*TERMINATION input is controlled by the \*CONTROL\_TERMINATION control card. Note that this type of termination is not active during dynamic relaxation.

Card 1            1            2            3            4            5            6            7            8

Variable	PID	STOP	MAXC	MINC				
Type	I	I	F	F				
Default	none	none	-	-				

#### VARIABLE

#### DESCRIPTION

PID	Part ID of rigid body, see *PART_OPTION.
STOP	Stop criterion: EQ.1: global x direction, EQ.2: global y direction, EQ.3: global z direction, EQ.4: stop if displacement magnitude is exceeded.
MAXC	Maximum (most positive) displacement, options 1, 2, 3 and 4: EQ.0.0: MAXC set to 1.0e21.
MINC	Minimum (most negative) displacement, options 1, 2 and 3 above only: EQ.0.0: MINC set to -1.0e21.



**\*TERMINATION\_CONTACT**

Purpose: The analysis terminates when the magnitude of the contact interface resultant force is zero. If more than one contact condition is input, the analysis stops when any of the conditions is satisfied. Termination by other means than \*TERMINATION input is controlled by the \*CONTROL\_TERMINATION control card. Note that this type of termination is not active during dynamic relaxation and does not apply to 2D contact types.

Card 1            1            2            3            4            5            6            7            8

Variable	CID	ACTIM	DUR	THRES	DOF			
Type	I	F	F	F	I			
Default	none	none	-	0.0	0			

<u>VARIABLE</u>	<u>DESCRIPTION</u>
CID	Contact ID. The contact ID is defined by the ordering of the contact input unless the TITLE option which allows the CID to be defined is used in the *CONTACT section.
ACTIM	Activation time.
DUR	Time duration of null resultant force prior to termination. This time is tracked only after the activation time is reached and the contact resultant forces are zero. EQ.0.0: Immediate termination after null force is detected.
THRES	Any measured force magnitude below or equal to this specified threshold is taken as a null force. Default=0.0
DOF	Option to consider only the force magnitude in the x, y, or z global directions corresponding to DOF=1,2, and 3, respectively.

# \*TERMINATION

# \*TERMINATION\_CURVE

## \*TERMINATION\_CURVE

Purpose: Terminate the calculation when the load curve value returns to zero. This termination can be used with the contact option \*CONTACT\_AUTO\_MOVE. In this latter option, the load curve is modified to account for the movement of the master surface.

Card 1            1            2            3            4            5            6            7            8

Variable	LCID	ATIME						
Type	I	F						
Default	none	Remark 1		-				

### VARIABLE

### DESCRIPTION

LCID

Load curve ID governing termination.

ATIME

Activation time. After this time the load curve is checked. If zero, see remark 1 below.

### Remarks:

1. If ATIME=0.0, termination will occur after the load curve value becomes nonzero and then returns to zero.

**\*TERMINATION\_DELETED\_SHELLS\_{OPTION}**

Available options include:

**<BLANK>**

**SET**

Purpose: Terminate the calculation when the number of deleted shells for a specified part ID exceeds the value defined here. This input has no effect for a part ID that is left undefined. Generally, this option should be used with the NFAIL1 and NFAIL4 parameters that are defined in the \*CONTROL\_SHELL control information.

Card 1            1            2            3            4            5            6            7            8

Variable	PID/PSID	NDS						
Type	I	I						
Default	none	none						

<u>VARIABLE</u>	<u>DESCRIPTION</u>
PID/PSID	Part ID or if option SET is active, part set ID.
NDS	Number of elements that must be deleted for the specified part ID's, before an error termination occurs.

# \*TERMINATION

# \*TERMINATION\_DELETED\_SOLIDS

## \*TERMINATION\_DELETED\_SOLIDS\_{OPTION}

Available options include:

<BLANK>

SET

Purpose: Terminate the calculation when the number of deleted solids for a specified part ID exceeds the value defined here. This input has no effect for a part ID that is left undefined.

Card 1            1            2            3            4            5            6            7            8

Variable	PID/PSID	NDS						
Type	I	I						
Default	none	1						

### VARIABLE

### DESCRIPTION

PID/PSID

Part ID or if option SET is active, part set ID.

NDS

Number of elements that must be deleted for the specified part ID's, before an error termination occurs.

**\*TERMINATION\_NODE****\*TERMINATION****\*TERMINATION\_NODE**

Purpose: Terminate calculation based on nodal point coordinates. The analysis terminates for \*TERMINATION\_NODE when the current position of the node specified reaches either the maximum or minimum value (stops 1, 2 or 3), or picks up force from any contact surface (stops 4). Termination by other means than \*TERMINATION is controlled by the \*CONTROL\_TERMINATION control card. Note that this type of termination is not active during dynamic relaxation.

Card 1            1            2            3            4            5            6            7            8

Variable	NID	STOP	MAXC	MINC				
Type	I	I	F	F				
Default	none	none	-	-				

**VARIABLE****DESCRIPTION**

NID	Node ID, see *NODE_OPTION.
STOP	Stop criterion: EQ.1: global x direction, EQ.2: global y direction, EQ.3: global z direction, EQ.4: stop if node touches contact surface.
MAXC	Maximum (most positive) coordinate (options 1, 2 and 3) above only.
MINC	Minimum (most negative) coordinate (options 1, 2 and 3) above only.

# \*TERMINATION

# \*TERMINATION\_SENSOR

## \*TERMINATION\_SENSOR

Purpose: Terminates the calculation when the switch condition defined in \*SENSOR\_SWITCH is met.

Card 1            1            2            3            4            5            6            7            8

Variable	SWID							
Type	I							
Default	none							

### VARIABLE

### DESCRIPTION

SWID	ID of *SENSOR_SWITCH which will terminate the calculation when its condition is met. Only one *TERMINATION_SENSOR is allowed. If more than one *TERMINATION_SENSOR is defined; only the last one is effective.
------	--

### Remarks:

An example allowing more than one sensor\_switch to terminate calculation:

```
*SENSOR_DEFINE_ELEMENT
$ Axial force of beam element 1
44,BEAM,1,AXIAL,FORCE
*SENSOR_DEFINE_ELEMENT
$ Axial force of beam element 2
55,BEAM,21,AXIAL,FORCE
*SENSOR_SWITCH
$a switch condition is met when the axial force of beam-1 >5.0
11,SENSOR,44,GT,5.
*SENSOR_SWITCH
$a switch condition is met when the axial force of beam-2 >10.0
22,SENSOR,55,GT,10.
*SENSOR_SWITCH
$a switch condition is met when time >50.
33,TIME, , 50
```

**\*SENSOR\_SWITCH\_CALC-LOGIC**

\$ a switch condition is met if both conditions of switch-11 **and** switch-33 are met, I.e.,

\$ axial force of beam-1>5.0 and time>50

44,11,33

**\*SENSOR\_SWITCH\_CALC-LOGIC**

\$ a switch condition is met if both conditions of switch-22 **and** switch-33 are met, I.e.,

\$ axial force of beam-2>10.0 and time>50

55,33,22

**\*SENSOR\_SWITCH\_CALC-LOGIC**

\$ a switch condition is met if the conditions of switch-44 **or** switch-55 is met, I.e.,

\$ axial force of beam-1>5.0 and time>50 **or**

\$ axial force of beam-2>10.0 and time>50

66,44,-55

**\*TERMINATION\_SENSOR**

\$ job will be terminated when the switch condition of switch-66 is met, I.e.,

\$ axial force of beam-1>5.0 and time>50 **or**

\$ axial force of beam-2>10.0 and time>50

66





---

# **\*TITLE**

**\*TITLE**

Purpose: Define job title.

Card            1            2            3            4            5            6            7            8

Variable	TITLE
Type	C
Default	LS-DYNA USER INPUT

**VARIABLE**

**DESCRIPTION**

TITLE

Heading to appear on output and in output files.



# **\*USER**

## **\*USER\_INTERFACE\_OPTION**

Available options include:

### **CONTROL**

### **FRICITION**

### **CONDUCTIVITY**

Purpose: Define user defined input and allocate storage for user defined subroutines for the contact algorithms. See also \*CONTROL\_CONTACT. The **CONTROL** option above allows the user to take information from the contact interface for further action, e.g., stopping the analysis. A sample user subroutine is provided in Appendix F.

The **FRICITION** option may be used to modify the Coulomb friction coefficients in contact types 3, 5, or 10 (\*CONTACT\_SURFACE\_TO\_SURFACE, \*CONTACT\_NODES\_TO\_SURFACE, or \*CONTACT\_ONE\_WAY\_SURFACE\_TO\_SURFACE) according to contact information or to use a friction coefficient database. A sample user-defined friction subroutine is provided in Appendix G. For the subroutine to be called, the static friction coefficient FS on Card 2 of \*CONTACT must be any nonzero value, and shell thickness offsets must be invoked in the contact by setting SHLTHK to 1 or 2 using \*CONTROL\_CONTACT or Opt. Card B in \*CONTACT. The array length USRFRC in \*CONTROL\_CONTACT should be set to a value no less than the sum of the number of history variables NOC and the number of user-defined input parameters in \*USER\_INTERFACE\_FRICITION.

The **CONDUCTIVITY** option is used to define heat transfer contact conductance properties for thermal contacts.

Card 1            1            2            3            4            5            6            7            8

Variable	IFID	NOC	NOCI	NHSV				
Type	I	I	I	I				
Default	none	none	None	O				

# \*USER

(Use as many cards as necessary to define NOCI variables)

Card 2...      1            2            3            4            5            6            7            8

Variable	UC1	UC2	UC3	UC4	UC5	UC6	UC7	UC8
Type	F	F	F	F	F	F	F	F

<u>VARIABLE</u>	<u>DESCRIPTION</u>
IFID	Interface number
NOC	Number of history variables for interface. The number should not exceed the length of the array defined on *CONTROL_CONTACT. See Remarks.
NOCI	Initialize the first NOCI history variables in the input. NOCI must be smaller or equal to NOC.
NHSV	Number of history variables per interface node (only for friction and conductivity interface).
UC1	First user defined input parameter.
UC2	Second user defined input parameter.
.	.
.	.
.	.
UCn	Last user defined input parameter, where n = NOCI.

## **Remarks:**

The (NOC) interface variables (of which NOCI are initialized) are passed as arguments to the user defined subroutine. See Appendix G for the full list of arguments passed to the subroutine.

This keyword is not supported by segment based contact which is invoked by setting SOFT=2 on optional card A of the \*CONTACT card.

**\*USER\_LOADING**

Purpose: Provide a means of applying pressure and force boundary conditions. The keyword \*USER\_LOADING activates this option. Input here is optional with the input being read until the next “\*” keyword appears. The data read here is to be stored in a common block provided in the user subroutine, LOADUD. This data is stored and retrieved from the restart files.

**(Insert as many cards as needed. The next \* card terminates input.)**

Card 1...            1            2            3            4            5            6            7            8

Variable	PARAM1	PARAM2	PARAM3	PARAM4	PARAM5	PARAM6	PARAM7	PARAM8
Type	F	F	F	F	F	F	F	F
Default	none	none	none	none	none	none	none	none

<u>VARIABLE</u>	<u>DESCRIPTION</u>
PARAMn	This is the nth user input parameter.

**\*USER\_LOADING\_SET**

Purpose: Provides a means to apply user-defined loading to a set of nodes or segments. Loading could be nodal force, body force, temperature distribution, and pressure on segment or beam.

(Insert as many cards as needed. The next \* card terminates input.)

Card 1...      1            2            3            4            5            6            7            8

Variable	SID	LTYPE	LCID	CID	SF1	SF2	SF3	IDULS
Type	I	A	I	I	F	F	F	I
Default	none	none	none	global	none	none	none	Seq. #

**VARIABLE****DESCRIPTION**

SID	ID of the set to which user-defined loading will be applied. Set type depends on the type of loading, see LTYPE.
LTYPE	<p>Loading rtpc:</p> <p>EQ.FORCEN: Force, unit=force, will be applied to node set SID,</p> <p>EQ.BODYFN: Body force density, unit=force/length<sup>3</sup>, will be applied to node set SID,</p> <p>EQ.TEMPTN: Temperature will be assigned to node set SID. This option cannot be coexist with *LOAD_THERMAL_VARIABLE. In other word, users can only use either this option or *LOAD_THERMAL_VARIABLE to specify temperature distribution, not both of them,</p> <p>EQ.PRESSS: Pressure, unit=force/length<sup>2</sup>, will be applied to segment set SID,</p> <p>EQ.PRESSB: Pressure, unit=force/length<sup>1</sup>, will be applied to beam set SID.</p>
LCID	Load curve, a function of time. Its current value, crv, is passed to user subroutine LOADSETUD.
CID	Optional coordinate system along which scale factors SF <sub>i</sub> is defined. Global system is the default system.
SF <sub>i</sub>	<p>Scale factor of loading magnitude, when LTYP LTYPE</p> <p>EQ.FORCEN/BODYFN: Scale factor along i'th direction of CID,</p> <p>EQ.PRESSS: SF<sub>1</sub> is used as the scale factor, SF<sub>2</sub> and SF<sub>3</sub> are ignored,</p> <p>EQ.PRESSB: Scale factor along r, s, t axis of beam.</p>

VARIABLE	DESCRIPTION
IDULS	Each USER_LOAD_SET can be assigned a unique ID, which is passed to user subroutine LOADSETUD and allows multiple loading definitions by using a single user subroutine, LOADSETUD. If no value is input, ls-dyna will assign a sequence number to each USER_LOAD_SET based on its definition sequence.

**Remarks:**

\*USER\_LOAD\_SET activates the loading defined in user subroutine LOADSETUD, part of dyn21.F. When both \*USER\_LOADING\_SET and \*USER\_LOADING are defined, \*USER\_LOADING is only used to define user-defined parameters, PARMn; not to activate user subroutine LOADUD. Therefore only loading defined in LOADSETUD will be applied.

More than one loading definitions can be defined and assigned a unique ID, that enables multiple loading to be taken care of by a single subroutine, LOADSETUD, as shown below:

```

subroutine loadsetud(time,lft,llt,crv,iduls,parm)
c
c  Input (not modifiable)
c  x  : coordinate of node or element center
c  d  : displacement of node or element center
c  v  : velocity of node or element center
c  temp: temperature of node or element center
c  crv : value of LCID at current time
c  isuls : id of user_loading_set
c  parm: parameters defined in *USER_LOADING
c  Output (defined by user)
c  udl : user-defined load value
  include 'nlqparm'
C_TASKCOMMON (aux8loc)
  common/aux8loc/
  & x1(nlq),x2(nlq),x3(nlq),v1(nlq),v2(nlq),v3(nlq),
  & d1(nlq),d2(nlq),d3(nlq),temp(nlq),udl(nlq),tmp(nlq,12)
c
c  sample code
c  if (iduls.eq.100) then
c    do i=lft,llt
c      your code here
c      udl(i)=.....
c    enddo
c  elseif (iduls.eq.200) then
c    do i=lft,llt
c      udl(i)=.....
c    enddo

```

```
c  endif  
   return  
   end
```



# RESTART INPUT DATA

In general three categories of restart actions are possible with LS-DYNA and are outlined in the following discussion:

- a) A simple restart occurs when LS-DYNA was interactively stopped before reaching the termination time. Then simply defining the R=rtf file on the execution line for LS-DYNA restarts the calculation from the termination point and the calculation will continue to the specified termination time-see INTRODUCTION, Execution Syntax. No additional input deck is required.
- b) If minor modifications are desired as, e.g.,
  - reset termination time,
  - reset output printing interval,
  - reset output plotting interval,
  - delete contact surfaces,
  - delete elements and parts,
  - switch deformable bodies to rigid,
  - switch rigid bodies to deformable,
  - change damping options.

This type of restart is called a small restart and the corresponding input deck a “small restart input deck.” All modifications to the problem made with the restart input deck will be reflected in subsequent restart dumps. All the members of the file families are consecutively numbered beginning from the last member. The small input deck replaces the standard input deck on the execution line which has at least the following contents:

LS-DYNA I=restartinput R=D3DUMPnn

where D3DUMPnn (or whatever name is chosen for the family member) is the nth restart file from the last run where the data is taken. LS-DYNA automatically detects that a small input deck is used since the I=restartinput file may contain the keywords:

**\*CHANGE\_OPTION**

**\*CONTROL\_DYNAMIC\_RELAXATION**

# RESTART INPUT DATA

---

**\*CONTROL\_SHELL**

**\*CONTROL\_TERMINATION**

**\*CONTROL\_TIMESTEP**

**\*DAMPING\_GLOBAL**

**\*DATABASE\_OPTION**

**\*DATABASE\_BINARY\_OPTION**

**\*DELETE\_OPTION**

**\*INTERFACE\_SPRINGBACK\_LSDYNA**

**\*RIGID\_DEFORMABLE\_OPTION**

**\*STRESS\_INITIALIZATION\_{OPTION}**

**\*TERMINATION\_OPTION**

**\*TITLE**

**\*KEYWORD** (see INTRODUCTION, Execution Syntax)

**\*CONTROL\_CPU**

**\*DEFINE\_OPTION**

**\*SET\_OPTION**

i.e., the keyword **\*STRESS\_INITIALIZATION** may not be used in the small restart. The user has to take care that nonphysical modifications to the input deck are avoided; otherwise, complete nonsense may be the result.

- c) If many modifications are desired a so-called full restart may be the appropriate choice. Then the keyword **\*STRESS\_INITIALIZATION** has to be provided in the input. As also outlined in the INTRODUCTION, Restart Analysis, either all parts can be initialized with the restart data or some selection of parts can be made for the stress initialization. See **\*STRESS\_INITIALIZATION**. In a full deck restart, deleted elements in this section will be deleted in the full deck automatically even though they are defined. Likewise, if it is necessary to change the velocity field, that must also be performed in this section using the **CHANGE\_VELOCITY\_....** options. The velocity field in the full deck part of the input is ignored.

**\*CHANGE**

**RESTART INPUT DATA**

**\*CHANGE\_OPTION**

Purpose: Change solution options.

Available options include:

- BOUNDARY\_CONDITION**
- CONTACT\_SMALL\_PENETRATION**
- CURVE\_DEFINITION**
- RIGID\_BODY\_CONSTRAINT**
- RIGID\_BODY\_INERTIA**
- RIGID\_BODY\_STOPPER**
- STATUS\_REPORT\_FREQUENCY**
- THERMAL\_PARAMETERS**
- VELOCITY**
- VELOCITY\_NODE**
- VELOCITY\_RIGID\_BODY**
- VELOCITY\_ZERO**

For **BOUNDARY\_CONDITION** option define an arbitrary number of cards giving the nodal ID and the additional translational displacement boundary condition code. Previous boundary condition codes will continue to be imposed, i.e., a fixed node cannot be freed with this option. This input terminates when the next “\*” card is encountered.

Card 1...	1	2	3	4	5	6	7	8
-----------	---	---	---	---	---	---	---	---

Variable	NID	BCC						
Type	I	I						

<u>VARIABLE</u>	<u>DESCRIPTION</u>
NID	Nodal point ID, see also *NODE.

<u>VARIABLE</u>	<u>DESCRIPTION</u>
BCC	New translational boundary condition code: EQ.1: constrained x displacement, EQ.2: constrained y displacement, EQ.3: constrained z displacement, EQ.4: constrained x and y displacements, EQ.5: constrained y and z displacements, EQ.6: constrained z and x displacements, EQ.7: constrained x, y, and z displacements.

For **CONTACT\_SMALL\_PENETRATION** option define an arbitrary number of cards giving a list of contact surface ID numbers where the small penetration check is to be turned on. This input terminates when the next “\*” card is encountered. See the PENCHK variable on the \*CONTACT definition.

Card 1...            1            2            3            4            5            6            7            8

Variable	ID1	ID2	ID3	ID4	ID5	ID6	ID7	ID8
Type	I	I	I	I	I	I	I	I

<u>VARIABLE</u>	<u>DESCRIPTION</u>
IDn	Contact ID for surface number n.

The **CURVE\_DEFINITION** option allows a load curve to be redefined. The new load curve must contain the same number of points as the curve it replaces. The curve should be defined in the DEFINE\_CURVE section of this manual. This input terminates when the next “\*” card is encountered. Any offsets and scale factors are ignored.

Card 1 2 3 4 5 6 7 8

Variable	LCID							
Type	I							

VARIABLE

DESCRIPTION

LCID Load curve ID

The **RIGID\_BODY\_CONSTRAINT** option allows translational and rotational boundary conditions on a rigid body to be changed. This input terminates when the next “\*” card is encountered. Also, see \*CONSTRAINED\_RIGID\_BODIES.

Card 1 2 3 4 5 6 7 8

Variable	PID	TC	RC					
Type	I	I	I					

VARIABLE

DESCRIPTION

PID Part ID, see \*PART.

TC Translational constraint:  
EQ.0: no constraints,  
EQ.1: constrained x displacement,  
EQ.2: constrained y displacement,  
EQ.3: constrained z displacement,  
EQ.4: constrained x and y displacements,  
EQ.5: constrained y and z displacements,  
EQ.6: constrained z and x displacements,  
EQ.7: constrained x, y, and z displacements.

RC Rotational constraint:  
EQ.0: no constraints,  
EQ.1: constrained x rotation,  
EQ.2: constrained y rotation,

# RESTART INPUT DATA

\*CHANGE

## VARIABLE

## DESCRIPTION

EQ.3: constrained z rotation,  
 EQ.4: constrained x and y rotations,  
 EQ.5: constrained y and z rotations,  
 EQ.6: constrained z and x rotations,  
 EQ.7: constrained x, y, and z rotations.

The **RIGID\_BODY\_INERTIA** option allows the mass and inertia properties of a rigid body to be changed. This input terminates when the next “\*” card is encountered. The inertia tensor is defined in the local system defined in \*MAT\_RIGID at the start of the calculation. This coordinate system, which is fixed in the rigid body, tracks the rigid body rotation.

Card            1            2            3            4            5            6            7            8

Variable	ID	PID	TM					
Type	I	I	F					

Card 2            1            2            3            4            5            6            7            8

Variable	IXX	IXY	IXZ	IYY	IYZ	IZZ		
Type	F	F	F	F	F	F		

## VARIABLE

## DESCRIPTION

ID            ID for this change inertia input.  
 PID            Part ID, see \*PART.  
 TM            Translational mass.  
 IXX             $I_{xx}$ , xx component of inertia tensor.  
 IXY             $I_{xy}$   
 IXZ             $I_{xz}$

<u>VARIABLE</u>	<u>DESCRIPTION</u>
IYY	$I_{yy}$ , yy component of inertia tensor.
IYZ	$I_{yz}$
IZZ	$I_{zz}$ , zz component of inertia tensor.

The **RIGID\_BODY\_STOPPER** option allows existing stoppers to be redefined. This input terminates when the next "\*" card is encountered. See \*CONSTRAINED\_RIGID\_BODY\_STOPPERS.

New stopper definitions cannot be introduced in this section. Existing stoppers can be modified.

Card 1            1            2            3            4            5            6            7            8

Variable	PID	LCMAX	LCMIN	PSIDMX	PSIDMN	LCVMNX	DIR	VID
Type	I	I	I	I	I	I	I	I
Default	required	0	0	0	0	0	required	0

Card 2            1            2            3            4            5            6            7            8

Variable	BIRTH	DEATH						
Type	F	F						
Default	0	1028						

<u>VARIABLE</u>	<u>DESCRIPTION</u>
PID	Part ID of master rigid body, see *PART.
LCMAX	Load curve ID defining the maximum coordinate as a function of time: EQ.0: no limitation of the maximum displacement. New curves can be defined by the *DEFINE_CURVE within the present restart deck.

<u>VARIABLE</u>	<u>DESCRIPTION</u>
LCMIN	Load curve ID defining the minimum coordinate as a function of time: EQ.0: no limitation of the minimum displacement. New curves can be defined by the *DEFINE_CURVE within the present restart deck.
PSIDMX	Optional part set ID of rigid bodies that are slaved in the maximum coordinate direction to the master rigid body. This option requires additional input by the *SET_PART definition.
PSIDMN	Optional part set ID of rigid bodies that are slaved in the minimum coordinate direction to the master rigid body. This option requires additional input by the *SET_PART definition.
LCVMNX	Load curve ID which defines the maximum absolute value of the velocity that is allowed within the stopper: EQ.0: no limitation of the minimum displacement.
DIR	Direction stopper acts in: EQ.1: x-translation, EQ.2: y-translation, EQ.3: z-translation, EQ.4: arbitrary, defined by vector VID, EQ.5: x-axis rotation, EQ.6: y-axis rotation, EQ.7: z-axis rotation, EQ.8: arbitrary, defined by vector VID.
VID	Vector for arbitrary orientation of stopper. The vector must be defined by a *DEFINE_VECTOR within the present restart deck.
BIRTH	Time at which stopper is activated.
DEATH	Time at which stopper is deactivated.

## **Remarks:**

The optional definition of part sets in minimum or maximum coordinate directions allows the motion to be controlled in an arbitrary direction.

The **STATUS\_REPORT\_FREQUENCY** option allows the output status interval to be changed.



**\*CHANGE**

# RESTART INPUT DATA

Card            1            2            3            4            5            6            7            8

Variable	IKEDIT							
Type	I							

**VARIABLE**

**DESCRIPTION**

IKEDIT            Problem status report interval steps in the D3HSP output file:  
EQ.0: interval remains unchanged.

The **THERMAL\_PARAMETERS** option allows parameters used by a thermal or coupled structural/thermal analysis to be changed. These parameters were initially defined on the \*CONTROL\_THERMAL cards. Two cards are defined for this option.

Card 1            1            2            3            4            5            6            7            8

Variable	TS	DT	TMIN	TMAX	DTEMP	TSCP		
Type	I	F	F	F	F	F		

Card 2            1            2            3            4            5            6            7            8

Variable	REFMAX	TOL						
Type	I	F						

**VARIABLE**

**DESCRIPTION**

TS            Thermal time step code:  
EQ.0: No change,  
EQ.1: Fixed time step,  
EQ.2: variable time step.

# RESTART INPUT DATA

\*CHANGE

<u>VARIABLE</u>	<u>DESCRIPTION</u>
DT	Thermal time step on restart: EQ.0: No change.
TMIN	Minimum thermal time step: EQ.0: No change.
TMAX	Maximum thermal time step: EQ.0: No change.
DTEMP	Maximum temperature change in a thermal time step: EQ.0: No change.
TSCP	Time step control parameter (0.0 < TSCP < 1.0 ): EQ.0: No change.
REFMAX	Maximum number of reformations per thermal time step: EQ.0: No change.
TOL	Non-linear convergence tolerance: EQ.0: No change.

The **VELOCITY\_NODE** and the **VELOCITY\_NODE\_ONLY** options allow the velocity of nodal points to be changed at restart. Termination of this input is when the next “\*” card is read. Undefined nodes will have their nodal velocities reset to zero if a \*CHANGE\_VELOCITY\_NODE definition is encountered in the restart deck. However, if any of the \*CHANGE\_VELOCITY or CHANGE\_VELOCITY\_NODE definitions have \_ONLY appended, then only the specified nodes will have their nodal velocities modified.

Card            1            2            3            4            5            6            7            8

Variable	NID	VX	VY	VZ	VXR	VYR	VZR	
Type	I	F	F	F	F	F	F	
Default	none	0.	0.	0.	0.	0.	0.	

<u>VARIABLE</u>	<u>DESCRIPTION</u>
NID	Node ID

<u>VARIABLE</u>	<u>DESCRIPTION</u>
VX	Translational velocity in x-direction.
VY	Translational velocity in y-direction.
VZ	Translational velocity in z-direction.
VXR	Rotational velocity about the x-axis.
VYR	Rotational velocity about the y-axis.
VZR	Rotational velocity about the z-axis.

**Remarks:**

1. If a node is initialized on more than one input card set, then the last set input will determine its velocity, unless it is specified on a \*CHANGE\_VELOCITY\_NODE card.
2. If both \*CHANGE\_VELOCITY and \*CHANGE\_VELOCITY\_ZERO cards are defined then all velocities will be reset to zero.

The **VELOCITY** and **VELOCITY\_ONLY** options allow a new velocity field to be imposed at restart. Termination of this input is when the next "\*" card is read. Undefined nodes will have their nodal velocities reset to zero if a \*CHANGE\_VELOCITY definition is encountered in the restart deck. However, if any of the \*CHANGE\_VELOCITY definitions have \_ONLY appended, then only the specified nodes will have their nodal velocities modified.

Card 1            1            2            3            4            5            6            7            8

Variable	NSID								
Type	I								
Default	none								
Remark	1								

# RESTART INPUT DATA

\*CHANGE

Card 2            1            2            3            4            5            6            7            8

Variable	VX	VY	VZ	VXR	VYR	VZR		
Type	F	F	F	F	F	F		
Default	0.	0.	0.	0.	0.	0.		

## VARIABLE

## DESCRIPTION

NSID	Nodal set ID containing nodes for initial velocity.
VX	Velocity in x-direction.
VY	Velocity in y-direction.
VZ	Velocity in z-direction.
VXR	Rotational velocity about the x-axis.
VYR	Rotational velocity about the y-axis.
VZR	Rotational velocity about the z-axis.

### Remarks:

1. If a node is initialized on more than one input card set, then the last set input will determine its velocity, unless it is specified on a \*CHANGE\_VELOCITY\_NODE card.
2. Undefined nodes will have their nodal velocities set to zero if a \*CHANGE\_VELOCITY definition is encountered in the restart deck.
3. If both \*CHANGE\_VELOCITY and \*CHANGE\_VELOCITY\_ZERO cards are defined then all velocities will be reset to zero.

The **VELOCITY\_RIGID\_BODY** option allows the velocity components of a rigid body to be changed at restart. Termination of this input is when the next "\*" card is read.

Card	1	2	3	4	5	6	7	8
------	---	---	---	---	---	---	---	---

Variable	PID	VX	VY	VZ	VXR	VYR	VZR	
Type	I	F	F	F	F	F	F	
Default	none	0.	0.	0.	0.	0.	0.	

**VARIABLE**

**DESCRIPTION**

PID	Part ID of rigid body.
VX	Translational velocity in x-direction.
VY	Translational velocity in y-direction.
VZ	Translational velocity in z-direction.
VXR	Rotational velocity about the x-axis.
VYR	Rotational velocity about the y-axis.
VZR	Rotational velocity about the z-axis.

**Remarks:**

1. Rotational velocities are defined about the center of mass of the rigid body.
2. Rigid bodies not defined in this section will not have their velocities modified.

The **VELOCITY\_ZERO** option resets the velocities to zero at the start of the restart. Only the \*CHANGE\_VELOCITY\_ZERO card is required for this option without any further input.

# RESTART INPUT DATA

## \*CONTROL\_DYNAMIC\_RELAXATION

### \*CONTROL\_DYNAMIC\_RELAXATION

Purpose: Define controls for dynamic relaxation.

Card            1            2            3            4            5            6            7            8

Variable	NRCYCK	DRTOL	DRFCTR	DRTERM	TSSFDR	IRELAL	EDTTL	IDRFLG
Type	I	F	F	F	F	I	F	I
Default	250	0.001	0.995	infinity	TSSFAC	0	0.0	0
Remarks	1	1	1	1	1			1

#### VARIABLE

#### DESCRIPTION

NRCYCK	Number of iterations between convergence checks, for dynamic relaxation option (default = 250).
DRTOL	Convergence tolerance for dynamic relaxation option (default = 0.001).
DRFCTR	Dynamic relaxation factor (default = .995).
DRTERM	Optional termination time for dynamic relaxation. Termination occurs at this time or when convergence is attained (default = infinity).
TSSFDR	Scale factor for computed time step during dynamic relaxation. If zero, the value is set to TSSFAC defined on *CONTROL_TERMINATION. After converging, the scale factor is reset to TSSFAC.
IRELAL	Automatic control for dynamic relaxation option based on algorithm of Papadrakakis [1981].
EDTTL	Convergence tolerance on automatic control of dynamic relaxation.
IDRFLG	Dynamic relaxation flag for stress initialization: EQ.0: not active, EQ.1: dynamic relaxation is activated.

**Remarks:**

1. If a dynamic relaxation relaxation analysis is being restarted at a point before convergence was obtained, then NRCYCK, DRTOL, DRFCTR, DRTERM and TSSFDR will default to their previous values, and IDRFLG will be set to 1.
2. If dynamic relaxation is activated after a restart from a normal transient analysis LS-DYNA continues the output of data as it would without the dynamic relaxation being active. This is unlike the dynamic relaxation phase at the beginning of the calculation when a separate database is not used. Only load curves that are flagged for dynamic relaxation are applied after restarting.

# RESTART INPUT DATA

\*CONTROL\_SHELL

## \*CONTROL\_SHELL

Purpose: Change failure parameters NFAIL1 and NFAIL2 if necessary. These parameters must be nonzero in the initial run.

Card 1            1            2            3            4            5            6            7            8

Variable								
Type								

Card 2            1            2            3            4            5            6            7            8

Variable						NFAIL1	NFAIL4	
Type						I	I	

### VARIABLE

### DESCRIPTION

NFAIL1

Flag to check for highly distorted under-integrated shell elements, print a message, and delete the element or terminate. Generally, this flag is not needed for one point elements that do not use the warping stiffness. A distorted element is one where a negative jacobian exists within the domain of the shell, not just at integration points. The checks are made away from the integration points to enable the bad elements to be deleted before an instability leading to an error termination occurs. This test will increase CPU requirements for one point elements.

EQ.1: print message and delete element.

EQ.2: print message, write D3DUMP file, and terminate

GT.2: print message and delete element. When NFAIL1 elements are deleted then write D3DUMP file and terminate. These NFAIL1 failed elements also include all shell elements that failed for other reasons than distortion. Before the D3DUMP file is written, NFAIL1 is doubled, so the run can immediately be continued if desired.



<u>VARIABLE</u>	<u>DESCRIPTION</u>
NFAIL4	<p>Flag to check for highly distorted fully-integrated shell elements, print a message, and delete the element or terminate. Generally, this flag is recommended. A distorted element is one where a negative jacobian exists within the domain of the shell, not just at integration points. The checks are made away from the integration points to enable the bad elements to be deleted before an instability leading to an error termination occurs.</p> <p>EQ.1: print message and delete element. EQ.2: print message, write D3DUMP file, and terminate GT.2: print message and delete element. When NFAIL4 elements are deleted then write D3DUMP file and terminate. These NFAIL4 failed elements also include all shell elements that failed for other reasons than distortion. Before the D3DUMP file is written, NFAIL4 is doubled, so the run can immediately be continued if desired.</p>

# RESTART INPUT DATA

**\*CONTROL\_TERMINATION**

## **\*CONTROL\_TERMINATION**

Purpose: Stop the job.

Card            1            2            3            4            5            6            7            8

Variable	ENDTIM	ENDCYC						
Type	F	I						

### VARIABLE

### DESCRIPTION

ENDTIM

Termination time:

EQ.0.0: Termination time remains unchanged.

ENDCYC

Termination cycle. The termination cycle is optional and will be used if the specified cycle is reached before the termination time.

EQ.0.0: Termination cycle remains unchanged.

### Remarks:

This is a reduced version of the \*CONTROL\_TERMINATION card used in the initial input deck.

\*CONTROL\_TIMESTEP

Purpose: Set time step size control using different options.

Card 1 2 3 4 5 6 7 8

Variable	DUMMY	tssfacc	ISDO	DUMMY	DT2MS	LCTM		
Type	F	F	I	F	F	I		

<u>VARIABLE</u>	<u>DESCRIPTION</u>
DUMMY	Dummy field, see remark 1 below.
TSSFAC	Scale factor for computed time step. EQ.0.0: TSSFAC remains unchanged.
ISDO	Basis of time size calculation for 4-node shell elements, ISDO 3-node shells use the shortest altitude for options 0,1 and the shortest side for option 2. This option has no relevance to solid elements, which use a length based on the element volume divided by the largest surface area: EQ.0: characteristic length=area/(longest side), EQ.1: characteristic length=area/(longest diagonal), EQ.2: based on bar wave speed and MAX [shortest side, area/longest side]. THIS LAST OPTION CAN GIVE A MUCH LARGER TIME STEP SIZE THAT CAN LEAD TO INSTABILITIES IN SOME APPLICATIONS, ESPECIALLY WHEN TRIANGULAR ELEMENTS ARE USED.
DUMMY	Dummy field, see remark 1 below.
DT2MS	New time step for mass scaled calculations. Mass scaling must be active in the time zero analysis. EQ.0.0: DT2MS remains unchanged.
LCTM	Load curve ID that limits maximum time step size: EQ.0: LCTM remains unchanged.

**Remarks:**

1. This a reduced version of the \*CONTROL\_TIMESTEP used in the initial analysis. The dummy fields are included to maintain compatibility. If using free format input then a 0.0 should be entered for the dummy values.

# RESTART INPUT DATA

\*DAMPING\_GLOBAL

## \*DAMPING\_GLOBAL

Purpose: Define mass weighted nodal damping that applies globally to the deformable nodes.

Card            1            2            3            4            5            6            7            8

Variable	LCID	VALDMP						
Type	I	F						
Default	0	0.0						

### VARIABLE

### DESCRIPTION

LCID

Load curve ID which specifies node system damping:

EQ.n: system damping is given by load curve n. The damping force applied to each node is  $f=-d(t) mv$ , where  $d(t)$  is defined by load curve n.

VALDMP

System damping constant,  $d$  (this option is bypassed if the load curve number defined above is nonzero).

**\*DATABASE\_OPTION**

Options for ASCII files include. If a file is not specified in the restart deck then the output interval for the file will remain unchanged.

<b>SECFORC</b>	Cross section forces.
<b>RWFORC</b>	Wall forces.
<b>NODOUT</b>	Nodal point data.
<b>ELOUT</b>	Element data.
<b>GLSTAT</b>	Global data.
<b>DEFORC</b>	Discrete elements.
<b>MATSUM</b>	Material energies.
<b>NCFORC</b>	Nodal interface forces.
<b>RCFORC</b>	Resultant interface forces.
<b>DEFGEO</b>	Deformed geometry file
<b>SPCFORC</b>	Set dt for spc reaction forces.
<b>SWFORC</b>	Nodal constraint reaction forces (spot welds and rivets).
<b>ABSTAT</b>	Set dt for airbag statistics.
<b>NODFOR</b>	Set dt for nodal force groups.
<b>BNDOUT</b>	Boundary condition forces and energy
<b>RBDOUT</b>	Set dt for rigid body data.
<b>GCEOUT</b>	Set dt for geometric contact entities.
<b>SLEOUT</b>	Set dt for sliding interface energy.
<b>JNTFORC</b>	Set dt for joint force file.
<b>SBTOUT</b>	Set dt for seat belt output file.
<b>AVSFLT</b>	Set dt for AVS database.
<b>MOVIE</b>	Set dt for MOVIE.
<b>MPGS</b>	Set dt for MPGS.
<b>TPRINT</b>	Set dt for thermal file.

# RESTART INPUT DATA

\*DATABASE

Card            1            2            3            4            5            6            7            8

Variable	DT							
Type	F							

VARIABLE

DESCRIPTION

DT

Time interval between outputs:  
EQ.0.0: output interval is unchanged.

**Remarks:**

To terminate output to a particular file set DT to a high value.

If IACCOP=2 was specified in \*CONTROL\_OUTPUT, the best results are obtained in the NODOUT file by keeping the same DT on restart. When DT is changed for NODOUT, oscillations may occur around the restart time. If DT is larger than initially specified in the original input file, more memory is required to store the time states for the averaging than was originally allocated. A warning message is printed, and the filtering is applied using the available memory. When DT is smaller than initially specified, more oscillations may appear in the output than earlier in the calculation because the frequency content of the averaged output increases as DT decreases.

\*DATABASE\_BINARY\_OPTION

Options for binary output files with the default names given include:

- D3PLOT**     Dt for complete output states.
- D3THDT**    Dt for time history data for element subsets.
- D3DUMP**    Binary output restart files. Define output frequency in cycles
- RUNRSF**    Binary output restart file. Define output frequency in cycles.
- INTFOR**    Dt for contact surface Interface database.

Card            1            2            3            4            5            6            7            8

Variable	DT/CYCL							
Type	F							

<u>VARIABLE</u>	<u>DESCRIPTION</u>
DT	Time interval between outputs. EQ.0.0: Time interval remains unchanged.
CYCL	Output interval in time steps. EQ.0.0: output interval remains unchanged.

# RESTART INPUT DATA

**\*DELETE**

**\*DELETE\_OPTION**

Available options are:

**CONTACT**

**CONTACT\_2DAUTO**

**ENTITY**

**PART**

**ELEMENT\_BEAM**

**ELEMENT\_SHELL**

**ELEMENT\_SOLID**

**ELEMENT\_TSHELL**

**FSI**

Purpose: Delete contact surfaces, ALE FSI couplings, parts, or elements by a list of IDs. There are two contact algorithms for two-dimensional problems: the line-to-line contact and the automatic contact defined by part ID's. Each uses their own numbering.

For **CONTACT**, **CONTACT\_2DAUTO**, **ENTITY**, **FSI**, or **PART** option.

Card            1            2            3            4            5            6            7            8

Variable	ID1	ID2	ID3	ID4	ID5	ID6	ID7	ID8
Type	I	I	I	I	I	I	I	I

**VARIABLE**

**DESCRIPTION**

IDI

Contact ID/Coupling ID/Part ID

**Remarks:**

For **\*DELETE\_CONTACT**/**\*DELETE\_FSI** a negative ID implies that the absolute value gives the contact surface/FSI coupling which is to be activated.



**\*DELETE**

## **RESTART INPUT DATA**

**For the four ELEMENT options. Termination of input is when the next “\*” card is read.**

Card            1            2            3            4            5            6            7            8

Variable	ESID							
Type	I							

**VARIABLE**

**DESCRIPTION**

ESID

Element set ID, see \*SET\_SOLID, \*SET\_BEAM, \*SET\_SHELL,  
\*SET\_TSHELL.

# RESTART INPUT DATA

\*INTERFACE\_SPRINGBACK

## \*INTERFACE\_SPRINGBACK\_LSDYNA

Purpose: Define a material subset for output to a stress initialization file “dynain”. The dynain file contains keyword commands that can be included in a subsequent input deck to initialize deformation, stress, and strain in parts. This file can be used, for example, to do an implicit springback analysis after an explicit forming analysis.

Card            1            2            3            4            5            6            7            8

Variable	PSID	NSHV						
Type	I	I						

**Optional list of nodal points that are constrained in the dynain file. This section is terminated by an “\*” indicating the next input section.**

Card            1            2            3            4            5            6            7            8

Variable	NID	TC	RC					
Type	I	F	F					
Default	none	0.	0.					

### VARIABLE

### DESCRIPTION

PSID	Part set ID for springback, see *SET_PART.
NSHV	Number of shell or solid history variables (beyond the six stresses and effective plastic strain) to be initialized in the interface file. For solids, one additional state variable (initial volume) is also written. If NSHV is nonzero, the element formulations, calculational units, and constitutive models should not change between runs. If NHSV exceeds the number of integration point history variables required by the constitutive model, only the number required is written; therefore, if in doubt, set NHSV to a large number.
NID	Node ID

<u>VARIABLE</u>	<u>DESCRIPTION</u>
TC	Translational constraint: EQ.0: no constraints, EQ.1: constrained x displacement, EQ.2: constrained y displacement, EQ.3: constrained z displacement, EQ.4: constrained x and y displacements, EQ.5: constrained y and z displacements, EQ.6: constrained z and x displacements, EQ.7: constrained x, y, and z displacements.
RC	Rotational constraint: EQ.0: no constraints, EQ.1: constrained x rotation, EQ.2: constrained y rotation, EQ.3: constrained z rotation, EQ.4: constrained x and y rotations, EQ.5: constrained y and z rotations, EQ.6: constrained z and x rotations, EQ.7: constrained x, y, and z rotations.

## \*RIGID\_DEFORMABLE\_OPTION

Available options include:

### CONTROL

**D2R** (Deformable to rigid part switch)

**R2D** (Rigid to deformable part switch)

Purpose: Define parts to be switched from rigid to deformable and deformable to rigid in a restart. It is only possible to switch parts on a restart if part switching was activated in the time zero analysis. See \*DEFORMABLE\_TO\_RIGID for details of part switching.

**\*RIGID\_DEFORMABLE\_CONTROL**

Card                    1                    2                    3                    4                    5                    6                    7                    8

Variable	NRBF	NCSF	RWF	DTMAX				
Type	I	I	I	F				
Default	0	0	0	none				

**VARIABLE****DESCRIPTION**

NRBF	Flag to delete or activate nodal rigid bodies. If nodal rigid bodies or generalized, weld definitions are active in the deformable bodies that are switched to rigid, then the definitions should be deleted to avoid instabilities: EQ.0: no change, EQ.1: delete, EQ.2: activate.
NCSF	Flag to delete or activate nodal constraint set. If nodal constraint/spot weld definitions are active in the deformable bodies that are switched to rigid, then the definitions should be deleted to avoid instabilities: EQ.0: no change, EQ.1: delete, EQ.2: activate.
RWF	Flag to delete or activate rigid walls: EQ.0: no change, EQ.1: delete, EQ.2: activate.
DTMAX	Maximum permitted time step size after restart.

# RESTART INPUT DATA

**\*RIGID\_DEFORMABLE\_D2R**

## **\*RIGID\_DEFORMABLE\_D2R**

Termination of this input is when the next "\*" card is read.

Card            1            2            3            4            5            6            7            8

Variable	PID	MRB						
Type	I	I						
Default	none	0						

### VARIABLE

### DESCRIPTION

PID	Part ID of the part which is switched to a rigid material.
MRB	Part ID of the master rigid body to which the part is merged. If zero, the part becomes either an independent or master rigid body.

**\*RIGID\_DEFORMABLE\_R2D**

Termination of this input is when the next “\*” card is read.

Card            1            2            3            4            5            6            7            8

Variable	PID							
Type	I							
Default	none							

**VARIABLE**

**DESCRIPTION**

PID

Part ID of the part which is switched to a deformable material.

## \*STRESS\_INITIALIZATION\_{OPTION}

This keyword allows a full deck restart to be performed in LS-DYNA. For a full deck restart a complete input deck has to be included in the restart deck. The stress initialization feature allows all or selected parts to be initialized on restart, using data from the d3dump or runrsf database.

The options that are available with this keyword are:

<BLANK>

DISCRETE

SEATBELT

## \*STRESS\_INITIALIZATION

If this card is specified without further input as described below then all parts in the new input deck that existed in the previous input deck (with or without the same part IDs) are initialized from the d3dump or runrsf database. Further all seatbelt and discrete parts are initialized.

If only a subset of parts is to be initialized in the new analysis then define as many of the following cards as necessary. Termination of this input is when the next “\*” card is read.

Card 1...      1            2            3            4            5            6            7            8

Variable	PIDO	PIDN						
Type	I	I						
Default	none	PIDO						

<u>VARIABLE</u>	<u>DESCRIPTION</u>
PIDO	Old part ID, see *PART.
PIDN	New part ID, see *PART: EQ.0: New part ID is the same as the old part ID.

### Remarks:

If one or more of the above cards are defined then discrete and seatbelt elements will not be initialized unless the additional option cards \*STRESS\_INITIALIZATION\_DISCRETE and \*STRESS\_INITIALIZATION\_SEATBELT are defined.



**\*STRESS\_INITIALIZATION\_DISCRETE**

Initialize all discrete parts from the old parts. No further input is required with this card. This card is not required if \*STRESS\_INITIALIZATION is specified without further input.

**\*STRESS\_INITIALIZATION\_SEATBELT**

Initialize all seatbelt parts from the old parts. No further input is required with this card. This card is not required if \*STRESS\_INITIALIZATION is specified without further input.

## \*TERMINATION\_OPTION

Purpose: Stops the job depending on some displacement conditions.

Available options include:

### NODE

### BODY

**Caution:** The inputs are different for the nodal and rigid body stop conditions. The nodal stop condition works on the global coordinate position, while the body stop condition works on the relative global translation. The number of termination conditions cannot exceed the maximum of 10 or the number specified in the original analysis.

The analysis terminates for \*TERMINATION\_NODE when the current position of the node specified reaches either the maximum or minimum value (stops 1, 2 or 3), or picks up force from any contact surface (stop 4). For \*TERMINATION\_BODY the analysis terminates when the center of mass displacement of the rigid body specified reaches either the maximum or minimum value (stops 1, 2 or 3) or the displacement magnitude of the center of mass is exceeded (stop 4). If more than one condition is input, the analysis stops when any of the conditions is satisfied. **This input completely overrides the existing termination conditions defined in the time zero run.**

Termination by other means is controlled by the \*CONTROL\_TERMINATION control card.

**For both options, the input is identical:**

Card            1            2            3            4            5            6            7            8

Variable	NID/PID	STOP	MAXC	MINC				
Type	I	I	F	F				
Default	none	none	-	-				

For the **NODE** option:

<u>VARIABLE</u>	<u>DESCRIPTION</u>
NID	Node ID

---

<u>VARIABLE</u>	<u>DESCRIPTION</u>
STOP	Stop criterion: EQ.1: global x direction, EQ.2: global y direction, EQ.3: global z direction, EQ.4: stop if node touches contact surface.
MAXC	Maximum (most positive) coordinate, options 1, 2 and 3 above only.
MINC	Minimum (most negative) coordinate, options 1, 2 and 3 above only.

For the **BODY** option:

---

<u>VARIABLE</u>	<u>DESCRIPTION</u>
PID	Part ID of rigid body
STOP	Stop criterion: EQ.1: global x direction, EQ.2: global y direction, EQ.3: global z direction, EQ.4: stop if displacement magnitude is exceeded.
MAXC	Maximum (most positive) displacement, options 1, 2, 3 and 4: EQ.0.0: MAXC set to 1.0e21
MINC	Minimum (most negative) displacement, options 1, 2 and 3 above only: EQ.0.0: MINC set to -1.0e21

# RESTART INPUT DATA

**\*TITLE**

**\*TITLE**

Purpose: Define job title.

Card            1            2            3            4            5            6            7            8

Variable	TITLE
Type	C
Default	LS-DYNA USER INPUT

**VARIABLE**

**DESCRIPTION**

TITLE

Heading to appear on output.

---

# REFERENCES

- Abbo, A.J., and S.W. Sloan, "A Smooth Hyperbolic Approximation to the Mohr-Coulomb Yield Criterion," *Computers and Structures*, Vol. 54, No. 1, (1995).
- Allen, D.J., Rule, W.K., Jones, S.E., "Optimizing Material Strength Constants Numerically Extracted from Taylor Impact Data", *Experimental Mechanics*, Vol. 37, No 3, September (1997).
- Allman, D.J., "A Compatible Triangular Element Including Vertex Rotations for Plane Elasticity Analysis," *Computers and Structures*, 19, 1-8, (1984).
- Anagnone, A.U. and J.T. Wang, "A Semi-Empirical Method for Estimating the Effective Leak and Vent Areas of an Airbag", *AMD-Vol. 237/BED-Vol. 45*, pp. 195-217, (1999).
- Anand, L. and M.E. Gurtin, "A theory of amorphous solids undergoing large deformations, with application to polymeric glasses," *International Journal of Solids and Structures*, 40, pp. 1465-1487 (2003)
- Aretz, H. "Applications of a New Plane Stress Yield Function to Orthotropic Steel and Aluminum Sheet Metals," *Modeling and Simulation in Materials Science and Engineering*, 12, 491-509 (2004).
- Argon, A.S., "A theory for the low-temperature plastic deformation of glassy polymers", *Philosophical Magazine*, 28, 839-865 (1973).
- Armstrong, P.J., and Frederick, C.O., "A Mathematical Representation of the Multiaxial Bauschinger Effect," *CEGB Report, RD/B/N731*, Berkeley Nuclear Laboratories (1966).
- Arruda, E. and M. Boyce, "A Three-Dimensional Constitutive Model for the Large Stretch Behavior of Rubber Elastic Materials," *Journal of the Mechanics and Physics of Solids*, Vol. 41, No. 2, pp. 389-412, (1993).
- Auricchio, F., R.L. Taylor and J. Lubliner, "Shape-memory alloys: macromodeling and numerical simulations of the superelastic behavior", *Computer Methods in Applied Mechanics and Engineering*, vol. 146, pp. 281-312, (1997).
- Auricchio, F. and R.L. Taylor, "Shape-memory alloys: modeling and numerical simulations of the finite-strain superelastic behavior", *Computer Methods in Applied Mechanics and Engineering*, vol. 143, pp. 175-194, (1997).
- Bahler AS: The series elastic element of mammalian skeletal muscle. *Am J Physiol* 213:1560-1564, (1967).
- Baker, E.L., "An Explosives Products Thermodynamic Equation of State Appropriate for Material Acceleration and Overdriven Detonation: Theoretical Background and

## REFERENCES

---

- Fourmulation," Technical Report ARAED-TR-911013, U.S. Army Armament Research, Development and Engineering Center, Picatinney Arsenal, New Jersey, 1991).
- Baker, E.L. and J. Orosz, J., "Advanced Warheads Concepts: An Advanced Equation of State for Overdriven Detonation," Technical Report ARAED-TR-911007, U.S. Army Armament Research, Development and Engineering Center, Picatinney Arsenal, New Jersey, (1991).
- Baker, E.L. and L.I. Stiel, "Improved Quantitative Explosive Performance Prediction Using Jaguar," 1997 Insensitive Munitions and Energetic Materials Technology Symposium, Tampa, FL, (1997).
- Bammann, D.J. and E.C. Aifantis, "A Model for Finite-Deformation Plasticity," *Acta Mechanica*, 70, 1-13 (1987).
- Bammann, D.J. and G. Johnson, "On the Kinematics of Finite-Deformation Plasticity," *Acta Mechanica*, 69, 97-117 (1987).
- Bammann, D.J., "Modeling the Temperature and Strain Rate Dependent Large Deformation of Metals," Proceedings of the 11th US National Congress of Applied Mechanics, Tuscon, AZ, (1989).
- Bammann, D.J., M.L. Chiesa, A. McDonald, W.A. Kawahara, J.J. Dike, and V.D. Revelli, "Predictions of Ductile Failure in Metal Structures," in AMD-Vol. 107, Failure Criteria and Analysis in Dynamic Response, Edited by. H.E. Lindberg, 7-12, (1990).
- Bandak, F.A., private communications, U.S. Dept. of Trans., Division of Biomechanics Research, 400 7th St., S.W. Washington, D.C. 20590 (1991).
- Barlat, F. and J. Lian, "Plastic Behavior and Stretchability of Sheet Metals. Part I: A Yield Function for Orthotropic Sheets Under Plane Stress Conditions," *Int. J. of Plasticity*, Vol. 5, pp. 51-66 (1989).
- Barlat, F., D.J. Lege, and J.C. Brem, "A Six-Component Yield Function for Anisotropic Materials," *Int. J. of Plasticity*, 7, 693-712, (1991).
- Barlat, F., Y. Maeda, K. Chung, M. Yanagawa, J.C. Brem, Y. Hayashida, D.J. Lege, K. Matsui, S.J. Murtha, S. Hattori, R.C. Becker, and S. Makosey, "Yield Function Development for Aluminum Alloy Sheets", *J. Mech. Phys. Solids*, Vol. 45, No. 11-12, 1727-1763, (1997).
- Barlat, F., Brem, J.C., Yoon, J.W., Chung, K., Dick, R.E., Lege, D.J., Pourboghrat, F., Choi, S.H., Chu, E., "Plane Stress Yield Function for Aluminum Alloy Sheets – Part 1: Theory, *Int. J. Plast.* 19, 1-23, (2003).
- Basu, U., "Explicit finite element perfectly matched layer for transient three-dimensional elastic waves," *International Journal for Numerical Methods in Engineering*, vol. 77, pp. 151–176, (2009).

## REFERENCES

---

- Basu, U. and Chopra, A.K., "Perfectly matched layers for time-harmonic elastodynamics of unbounded domains theory and finite-element implementation," *Computer Methods in Applied Mechanics and Engineering*, vol. 192, pp. 1337–1375, (2003).
- Basu, U. and Chopra, A.K., "Perfectly matched layers for transient elastodynamics of unbounded domains," *International Journal for Numerical Methods in Engineering*, vol. 59, pp. 1039–1074, (2004). Erratum: *Ibid.* vol. 61, pp. 156–157, (2004).
- Bathe, K.-J. and Dvorkin, E.N. A four node plate bending element based on Mindlin-Reissner plate theory and a mixed interpolation, *Int. J. Num. Meth. Eng.*, 21, 367-383 (1985).
- Batoz, J.L. and Ben Tahar, M. Evaluation of a new quadrilateral thin plate bending element, *Int. J. Num. Meth. Eng.*, 18, 1644-1677 (1982).
- Batoz, J.-L. and M. Ben Tahar, Evaluation of a new quadrilateral thin plate bending element, *International Journal for Numerical Methods in Engineering*, 18, (1982), 1655-1677.
- Bazeley, G.P., W.K. Cheung, R.M. Irons, and O.C. Zienkiewicz, "Triangular Elements in Plate Bending-Confirming and Nonconforming Solutions in Matrix Methods and Structural Mechanics," *Proc. Conf. on Matrix Methods in Structural Analysis*, Rept. AFFDL-R-66-80, Wright Patterson AFB, 547-576 (1965).
- Belytschko, T. and Bindeman, L. P. "Assumed Strain Stabilization of the Eight Node Hexahedral Element," *Comp. Meth. Appl. Mech. Eng.* **105**, 225-260 (1993).
- Belytschko, T.B. and A.H. Marchertas, "Nonlinear Finite Element Method for Plates and its Application to the Dynamic Response of Reactor Fuel Subassemblies," *Trans, ASME J. Pressure Vessel Tech.*, 251-257 (1974).
- Belytschko, T.B. and C.S. Tsay, "Explicit Algorithms for Nonlinear Dynamics of Shells," *AMD-Vol.48, ASME*, 209-231 (1981).
- Belytschko, T.B. and C.S. Tsay, "Explicit Algorithms for Nonlinear Dynamics of Shells," *Comp. Meth. Appl. Mech. Eng.*, 43, 251-276, (1984).
- Belytschko, T.B. and C.S. Tsay, "A Stabilization Procedure for the Quadrilateral Plate Element with One-Point Quadrature," *Int. J. Num. Method. Eng.*, 19, 405-419 (1983).
- Belytschko, T.B., H. Stolarski, and N. Carpenter, "A  $C^0$  Triangular Plate Element with One-Point Quadrature," *Int. J. Num. Meth. Eng.*, 20, 787-802 (1984).
- Belytschko, T.B., L. Schwer, and M.J. Klein, "Large Displacement Transient Analysis of Space Frames," *Int. J. Num. Eng.*, 11, 65-84 (1977).
- Benson, D.J. and J.O. Hallquist, "A Simple Rigid Body Algorithm for Structural Dynamics Programs," *Int. J. Numer. Meth. Eng.*, 22, (1986).
- Benson, D.J. and J.O. Hallquist, "A Single Surface Contact Algorithm for the Postbuckling Analysis of Shell Structures," *Comp. Meths. Appl. Mech. Eng.*, 78, 141-163 (1990).

## REFERENCES

---

- Benzeggagh, M.L. and Kenane, M., "Measurement of Mixed-mode Delamination Fracture Toughness of Unidirectional Glass/Epoxy Composites with Mixed-mode Bending Apparatus," *Composites Science and Technology*, 56, 439-449 (1996).
- Berstad, T., "Material Modeling of Aluminium for Crashworthiness Analysis", Dr.Ing. Dissertation, Department of Structural Engineering, Norwegian University of Science and Technology, Trondheim, Norway, (1996).
- Berstad, T., Hopperstad, O.S., Lademo, O.-G. and Malo, K.A., "Computational Model of Ductile Damage and Fracture in Shell Analysis", *Second European LS-DYNA Conference*, Gothenburg, Sweden, (1999).
- Berstad, T., Lademo, O.-G., Pedersen, K.O. and Hopperstad, O.S., "Formability modeling with LS-DYNA", 8<sup>th</sup> International LS-DYNA User's Conference, Detroit, May 3-5, 2004.
- Berstad, T., Langseth, M. and Hopperstad, O.S., "Elasto-viscoplastic Constitutive Models in the Explicit Finite Element Code LS-DYNA3D," Second International LS-DYNA3D conference, San Francisco, (1994).
- Bielak, J. and Christiano, P., "On the effective seismic input for non-linear soil-structure interaction systems," *Earthquake Engineering and Structural Dynamics*, vol. 12, pp. 107-119, (1984).
- Bilkhu, S.S., M. Founas, and G.S. Nasholtz, "Material Modeling of Structural Foams in Finite Element Analysis Using Compressive Uniaxial and Triaxial Data," *SAE (Nat. Conf.) Detroit 1993*, pp. 4-34.
- Blatz, P.J., and Ko, W.L., "Application of Finite Element Theory to the Deformation of Rubbery Materials," *Trans. Soc. of Rheology*, 6, 223-251 (1962).
- Boyce, M.C., Parks, D.M., and Argon, A.S., "Large inelastic deformation of glassy polymers. Part I: Rate dependent constitutive model". *Mechanics of Materials*, 7, 15-33 (1988).
- Boyce, M.C., Socrate, C. and Llana, P.G., "Constitutive model for the finite deformation stress-strain behavior of poly(ethylene terephthalate) above the glass transition". *Polymer*, 41, 2183-2201 (2000).
- Brekelmans, W.A.M., Scheurs, P.J.G., and de Vree, J.H.P., 1991, "Continuum damage mechanics for softening of brittle materials", *Acta Mechanica*, vol 93, pp 133-143
- Broadhouse, B.J., "The Winfrith Concrete Model in LS-DYNA3D," Report: SPD/D(95)363, Structural Performance Department, AEA Technology, Winfrith Technology Centre, U.K. (1995).
- Broadhouse, B.J. and Neilson, A.J., "Modelling Reinforced Concrete Structures in DYNA3D", Safety and Engineering Division, United Kingdom Atomic Energy Authority, Winfrith, AEEW-M 2465, 1987.



## REFERENCES

---

- Brode, H.L., "Height of Burst Effects at High Overpressure," RAND, RM-6301-DASA, DASA 2506, (1970).
- Brown, B.E. and J.O. Hallquist, "TAURUS: An Interactive Post-Processor for the Analysis Codes NIKE3D, DYNA3D, TACO3D, and GEMINI," University of California, Lawrence Livermore National Laboratory, Rept. UCID-19392 (1982) Rev. 1 (1984).
- Bruneau, M., Uang, C.M., Whittaker, A., Ductile Design of Steel Structures, McGraw Hill, (1998).
- Burton, D.E. et al. "Physics and Numerics of the TENSOR Code," Lawrence Livermore National Laboratory, Internal Document UCID-19428, (July 1982).
- CEB Code 1993, Comite euro-international du beton, CEB-FIP Model Code 1990, Thomas Telford, London, (1993).
- Chang, F.K. and K.Y. Chang, "A Progressive Damage Model for Laminated Composites Containing Stress Concentration," J. of Composite Materials, 21, 834-855 (1987a).
- Chang, F.K. and K.Y. Chang, "Post-Failure Analysis of Bolted Composite Joints in Tension or Shear-Out Mode Failure," J. of Composite Materials, 21 809-823 (1987b).
- Chang, F.S., "Constitutive Equation Development of Foam Materials," Ph.D. Dissertation, submitted to the Graduate School, Wayne State University, Detroit, Michigan (1995).
- Chen, W.F., and Baladi, G.Y., Soil Plasticity: Theory and Implementation, Elsevier, New York, (1985).
- Cheng, H., Obergefell, L.A., and Rizer, A., March 1994, "Generator of Body (GEBOD) Manual," Report No. AL/CF-TR-1994-0051.
- Chowdhury, S.R. and Narasimhan R., "A Cohesive Finite Element Formulation for Modeling Fracture and Delamination in Solids," Sadhana, 25(6), 561-587, (2000).
- Christensen, R.M. "A Nonlinear Theory of Viscoelasticity for Application to Elastomers," Journal of Applied Mechanics, Volume 47, American Society of Mechanical Engineers, pages 762-768, December 1980.
- Chu, C.C. and A. Needleman, "Void Nucleation Effects in Biaxially Stretched Sheets", ASME Journal of Engineering Materials and Technology, 102, 249-256 (1980).
- Chung, K. and K. Shah, "Finite Element Simulation of Sheet Metal Forming for Planar Anisotropic Metals," Int. J. of Plasticity, 8, 453-476, (1992).
- Cochran, S.G. and J. Chan, "Shock Initiation and Detonation Models in One and Two Dimensions," University of California, Lawrence Livermore National Laboratory, Rept. UCID-18024 (1979).
- Cook, R. D., Concepts and Applications of Finite Element Analysis, John Wiley and Sons, Inc. (1974).

## REFERENCES

---

- Couch, R., E. Albright, and N. Alexander, The Joy Computer Code, Lawrence Livermore National Laboratory, Internal Document Rept. UCID-19688, (January, 1983).
- Cowper, G.R. and P.S. Symonds, Strain Hardening and Strain Rate Effects in the Impact Loading of Cantilever Beams, Brown University, Applied Mathematics Report, 1958.
- CRAY-1 Computer System CFT Reference Manual, Cray Research Incorporated, Bloomington, NM., Publication No. 2240009 (1978).
- DeRuntz, J.A. Jr., "Reference Material for USA, The Underwater Shock Analysis Code, USA-STAGS, and USA-STAGS-CFA," Report LMSC-P032568, Computational Mechanics Laboratory, Lockheed Palo Alto Research Laboratory, Palo Alto, CA. (1993).
- Desai, C.S., and H.J. Siriwardane, Constitutive Laws for Engineering Materials with Emphasis On Geologic Materials, Prentice-Hall, Chapter 10, (1984).
- Deshpande, V.S. and N.A. Fleck, "Isotropic Models for Metallic Foams," *Journal of the Mechanics and Physics of Solids*, 48, 1253-1283, (2000).
- Dick, R.E., and W.H. Harris, "Full Automated Rezoning of Evolving Geometry Problems," *Numerical Methods in Industrial Forming Processes*, Chenot, Wood, and Zienkiewicz, Editors, Balkema, Rotterdam, 243-248, (1992).
- Dilger, W.H., R. Koch, and R. Kowalczyk, "Ductility of Plain and Confined Concrete Under Different Strain Rates," *ACI Journal*, January-February, (1984).
- Dobratz, B.M., "LLNL Explosives Handbook, Properties of Chemical Explosives and Explosive Simulants," University of California, Lawrence Livermore National Laboratory, Rept. UCRL-52997 (1981).
- Du Bois, P.A., "Numerical Simulation of Strandfoam" Daimler-Chrysler AG Abt. EP/CSV, Report (2001).
- Dufailly, J., and Lemaitre, J., "Modeling very low cycle fatigue", *International Journal of damage mechanics*, 4, pp. 153-170 (1995).
- Englemann, B. E., R.G. Whirley, and G.L. Goudreau, "A Simple Shell Element Formulation for Large-Scale Elastoplastic Analysis," CED-Vol. 3. Analytical and Computational Models of Shells, A.K. Noor, T. Belytschko, and J.C. Simo, Editors, 1989, pp. 399-416.
- Faßnacht, W., "Simulation der Ribbildung in Aluminiumgußbauteilen," Dissertation, Technische Universität Darmstadt, (1999).
- Feng, W.W. and Hallquist, J.O., "On Constitutive Equations for Elastomers and Elstomeric Foams", The 4<sup>th</sup> European LS-DYNA Conference, D-II-15, Ulm, Germany, May 2003.
- Feucht, M., "Ein gradientenabhängiges Gursonmodell zur Beshreibung duktiler Schädigung mit Entfestigung," Dissertation, Technische Universität Darmstadt, (1998).

## REFERENCES

---

- Fiolka, M. and Matzenmiller, A., "Delaminationsberechnung von Faserverbundstrukturen", PAMM Proc. Appl. Math. Mech. 5, S.393-394 (2005).
- Flanagan, D.P. and T. Belytschko, "A Uniform Strain Hexahedron and Quadrilateral and Orthogonal Hourglass Control," Int. J. Numer. Meths. Eng., 17, 679-706 (1981).
- Forghani A., "A Non-Local Approach to Simulation of Damage in Composite Structures", PhD Thesis, Department of Civil Engineering, The University of British Columbia,, Vancouver, Canada, (2011).
- Forghani A., Zobeiry N., Vaziri R., Poursartip A., and Ellyin F., "A Non-Local Approach to Simulation of Damage in Laminated Composites." Proc., ASC/CANCOM Conference, Montreal, Canada (2011b).
- Forghani A., Zobeiry N., Poursartip A., and Vaziri R., "A Structural Modeling Framework for Prediction of Damage Development and Failure of Composite Laminates". Accepted for publication in Composites Sci. Technol.
- Freed AD., Einstein DR. and Vesely I., "Invariant Formulation for Dispersed Transverse Isotropy in Aortic Heart Valves – An Efficient Means for Modeling Fiber Splay", Biomechan Model Mechanobiol, 4, 100-117 (2005)
- Fung, Y.C., Biomechanics, Springer, New York, 1993.
- Fung, Y.C., Foundations of Solid Mechanics, Prentice Hall, Inc., Englewood Cliffs, New Jersey, 1965.
- Gerlach, S., Fiolka M. and Matzenmiller, A., Modelling and analysis of adhesively bonded joints with interface elements for crash analysis, 4. LS-DYNA Forum, 20-21, (2005) Bamberg, DYNAmore GmbH, Stuttgart.
- Ginsberg, M. and J. Johnson, "Benchmarking the Performance of Physical Impact Simulation Software on Vector and Parallel Computers," Applications Track of Supercomputing, IEEE monograph, Computer Society Press, March, 1989.
- Giroux, E.D. HEMP User's Manual, University of California, Lawrence Livermore National Laboratory, Rept. UCRL-51079 (1973).
- Goudreau, G.L. and J.O. Hallquist, "Recent Developments in Large Scale Finite Element Lagrangian Hydrocode Technology," J. Comp. Meths. Appl. Mechs. Eng., 30 (1982).
- Goldak, J., Chakravarti, A., and Bibby, M., "A New Finite Element Model for Welding Heat Sources," Metallurgical Transactions B, vol. 15B, pp. 299-305, June, 1984.
- Govindjee, S., Kay, J.G., and Simo, J.C. [1994], Anisotropic Modeling and Numerical Simulation of Brittle Damage in Concrete, Report No. UCB/SEMM-94/18, Department of Civil Engineering, University of California, Berkeley, CA 94720.
- Govindjee, S., Kay, J.G., and Simo, J.C. [1995], "Anisotropic Modeling and Numerical Simulation of Brittle Damage in Concrete," Int. J. Numer. Meth. Engng, **38**, 3611-3633.

## REFERENCES

---

- Graefe, H., W. Krummheuer, and V. Siejak, "Computer Simulation of Static Deployment Tests for Airbags, Air Permeability of Uncoated Fabrics and Steady State Measurements of the Rate of Volume Flow Through Airbags," SAE Technical Paper Series, 901750, Passenger Car Meeting and Exposition, Dearborn, Michigan, September 17-20, 1990.
- Gran, J.K. and P.E. Senseny, "Compression Bending of Scale-Model Reinforced-Concrete Walls," ASCE Journal of Engineering Mechanics, Volume 122, Number 7, pages 660-668, July (1996).
- Guccione, J., A. McCulloch, and L. Waldman, "Passive Material Properties of Intact Ventricular Myocardium Determined from a Cylindrical Model", ASME Journal of Biomechanical Engineering, Vol. 113, pages 42-55, (1991).
- Guccione JM, Waldman LK, McCulloch AD., "Mechanics of Active Contraction in Cardiac Muscle: Part II – Cylindrical Models of the Systolic Left Ventricle", J. Bio Mech, 115, 82-90, (1993).
- Gurson, A.L., Plastic Flow and Fracture Behavior of Ductile Materials Incorporating Void Nucleation, Growth, and Interaction, Ph.D. Thesis, Brown University, (1975).
- Gurson, A.L., "Continuum Theory of Ductile Rupture by Void Nucleation and Growth: Part I - Yield Criteria and Flow Rules for Porous Ductile Media", J. of Eng. Materials and Technology, (1977).
- Hallquist, J.O., Preliminary User's Manuals for DYNA3D and DYNAP (Nonlinear Dynamic Analysis of Solids in Three Dimension), University of California, Lawrence Livermore National Laboratory, Rept. UCID-17268 (1976) and Rev. 1 (1979).[a]
- Hallquist, J.O., A Procedure for the Solution of Finite Deformation Contact-Impact Problems by the Finite Element Method, University of California, Lawrence Livermore National Laboratory, Rept. UCRL-52066 (1976).
- Hallquist, J.O., "A Numerical Procedure for Three-Dimensional Impact Problems," American Society of Civil Engineering, Preprint 2956 (1977).
- Hallquist, J.O., "A Numerical Treatment of Sliding Interfaces and Impact," in: K.C. Park and D.K. Gartling (eds.) Computational Techniques for Interface Problems, AMD Vol. 30, ASME, New York (1978).
- Hallquist, J.O., NIKE2D: An Implicit, Finite-Element Code for Analyzing the Static and Dynamic Response of Two-Dimensional Solids, University of California, Lawrence Livermore National Laboratory, Rept. UCRL-52678 (1979).[b]
- Hallquist, J.O., User's Manual for DYNA2D – An Explicit Two-Dimensional Hydrodynamic Finite Element Code with Interactive Rezoning, University of California, Lawrence Livermore National Laboratory, Rept. UCID-18756 (1980).

## REFERENCES

---

- Hallquist, J.O., User's Manual for DYNA3D and DYNAP (Nonlinear Dynamic Analysis of Solids in Three Dimensions), University of California, Lawrence Livermore National Laboratory, Rept. UCID-19156 (1981).[a]
- Hallquist, J. O., NIKE3D: An Implicit, Finite-Deformation, Finite-Element Code for Analyzing the Static and Dynamic Response of Three-Dimensional Solids, University of California, Lawrence Livermore National Laboratory, Rept. UCID-18822 (1981).[b]
- Hallquist, J.O., DYNA3D User's Manual (Nonlinear Dynamic Analysis of Solids in Three Dimensions), University of California, Lawrence Livermore National Laboratory, Rept. UCID-19156 (1982; Rev. 1: 1984; Rev. 2: 1986).
- Hallquist, J.O., Theoretical Manual for DYNA3D, University of California, Lawrence Livermore National Laboratory, Rept. UCID-19501 (March, 1983).
- Hallquist, J.O., DYNA3D User's Manual (Nonlinear Dynamic Analysis of Solids in Three Dimensions), University of California, Lawrence Livermore National Laboratory, Rept. UCID-19156 (1988, Rev. 4).
- Hallquist, J.O., LS-DYNA User's Manual (Nonlinear Dynamic Analysis of Solids in Three Dimensions), Livermore Software Technology Corporation, Rept. 1007 (1990).
- Hallquist, J.O., D.J. Benson, and G.L. Goudreau, "Implementation of a Modified Hughes-Liu Shell into a Fully Vectorized Explicit Finite Element Code," Proceedings of the International Symposium on Finite Element Methods for Nonlinear Problems, University of Trondheim, Trondheim, Norway (1985).
- Hallquist, J.O. and D.J. Benson, "A Comparison of an Implicit and Explicit Implementation of the Hughes-Liu Shell," Finite Element Methods for Plate and Shell Structures, T.J.R. Hughes and E. Hinton, Editors, 394-431, Pineridge Press Int., Swansea, U.K. (1986).
- Hallquist, J.O. and D.J. Benson, DYNA3D User's Manual (Nonlinear Dynamic Analysis of Solids in Three Dimensions), University of California, Lawrence Livermore National Laboratory, Rept. UCID-19156 (Rev. 2: 1986; Rev. 3: 1987).
- Hallquist, J.O., D.W. Stillman, T.J.R. Hughes, C. and Tarver,"Modeling of Airbags Using MVMA/DYNA3D," LSTC Report (1990).
- Hashin, Z, "Failure Criteria for Unidirectional Fiber Composites," Journal of Applied Mechanics, 47, 329 (1980).
- Hänsel, C., P. Hora, and J. Reissner, "Model for the Kinetics of Strain-Induced Martensitic Phase Transformation at Isothermal Conditions for the Simulation of Sheet Metal Forming Processes with Metastable Austenitic Steels," Simulation of Materials Processing: Theory, Methods, and Applications, Huétink and Baaijens (eds), Balkema, Rotterdam, (1998).
- Haward, R.N., and Thackray, G., "The use of a mathematical model to describe isothermal stress-strain curves in glassy thermoplastics". Proc Roy Soc A, 302, 453-472 (1968).

## REFERENCES

---

- Herrmann, L.R. and F.E. Peterson, "A Numerical Procedure for Viscoelastic Stress Analysis," Seventh Meeting of ICRPG Mechanical Behavior Working Group, Orlando, FL, CPIA Publication No. 177, 1968.
- Hill A.V., "The heat of shortening and the dynamic constants of muscle," Proc Roy Soc B126:136-195, (1938).
- Hill, R., "A Theory of the Yielding and Plastic Flow of Anisotropic Metals," Proceedings of the Royal Society of London, Series A., Vol. 193, pp. 281-197 (1948).
- Hill, R., "Aspects of Invariance in Solid Mechanics," Advances in Applied Mechanics, Vol. 18, pp. 1-75 (1978).
- Hill, R., "Constitutive Modeling of Orthotropic Plasticity in Sheet Metals," J. Mech. Phys. Solids, Vol. 38, No. 3, 1989, pp. 405-417.
- Hirth, A., P. Du Bois, and K. Weimar, "Improvement of LS-DYNA Material Law 83 (Fu Chang) for the Industrial Simulation of Reversible Energy-Absorbing Foams," CAD-FEM User's Meeting, Bad Neuenahr - Ahrweiler, Germany, October 7-9, Paper 2-40, (1998).
- Holmquist, T.J., G.R. Johnson, and W.H. Cook, "A Computational Constitutive Model for Concrete Subjected to Large Strains, High Strain Rates, and High Pressures", Proceedings 14th International Symposium on Ballistics, Quebec, Canada, pp. 591-600, (1993).
- Hopperstad, O.S. and Remseth, S., "A return Mapping Algorithm for a Class of Cyclic Plasticity Models", International Journal for Numerical Methods in Engineering, Vol. 38, pp. 549-564, (1995).
- Huang, Yuli, private communication, Livermore, (2006).
- Hughes, T.J.R. and E. Carnoy, "Nonlinear Finite Element Shell Formulation Accounting for Large Membrane strains," AMD-Vol.48, ASME, 193-208 (1981).
- Hughes, T.J.R. and W.K. Liu, "Nonlinear Finite Element Analysis of Shells: Part I. Three-Dimensional Shells." Comp. Meths. Appl. Mechs., 27, 331-362 (1981a).
- Hughes, T.J.R. and W.K. Liu, "Nonlinear Finite Element Analysis of Shells: Part II. Two-Dimensional Shells." Comp. Meths. Appl. Mechs., 27, 167-181 (1981b).
- Hughes, T.J.R., W.K. Liu, and I. Levit, "Nonlinear Dynamics Finite Element Analysis of Shells." Nonlinear Finite Element Analysis in Struct. Mech., Eds. W. Wunderlich, E. Stein, and K.J. Bathe, Springer-Verlag, Berlin, 151- 168 (1981c).
- Huh, H. and Kang, W.J., "Crash-Worthiness Assessment of Thin-Walled Structures with the High-Strength Steel Sheet", Int. Journal of Vehicle Design, Vol. 30, Nos. 1/2 (2002).
- Ibrahimbegovic, A. and Wilson, E.L. "A unified formulation for triangular and quadrilateral flat shell finite elements with six nodal degrees of freedom", Comm. Applied Num. Meth, 7, 1-9 (1991).

## REFERENCES

---

- Isenberg, J., Vaughan, D.K., Sandler, I.S., Nonlinear Soil-Structure Interaction, Electric Power Research Institute report EPRI NP-945, Weidlinger Associates (1978).
- Ivanov, I., and A. Tabiei, "Loosely Woven Fabric Model With Viscoelastic Crimped Fibers for Ballistic Impact Simulations", *IJNME*, 57, (2004).
- Jabareen, M., and Rubin, M.B., A Generalized Cosserat Point Element (CPE) for Isotropic Nonlinear Elastic Materials including Irregular 3-D Brick and Thin Structures, *J. Mech. Mat. And Struct.*, Vol 3-8, 1465-1498 (2008).
- Johnson, G.C. and D.J. Bammann, "A discussion of stress rates in finite deformation problems," *Int. J. Solids Struct*, 20, 725-737 (1984).
- Johnson, G.R. and W.H. Cook, "A Constitutive Model and Data for Metals Subjected to Large Strains, High Strain Rates and High Temperatures." Presented at the Seventh International Symposium on Ballistics, The Hague, The Netherlands, April 1983.
- Johnson, G.R. and T.J. Holmquist, "An Improved Computational Model for Brittle Materials" in *High-Pressure Science and Technology - 1993 American Institute of Physics Conference Proceedings 309* (c 1994) pp.981-984 ISBN 1-56396-219-5.
- Jones, R.M., *Mechanics of Composite Materials*, Hemisphere Publishing Corporation, New York, (1975).
- Kenchington, G.J., "A Non-Linear Elastic Material Model for DYNA3D," Proceedings of the DYNA3D Users Group Conference, published by Boeing Computer Services (Europe) Limited (1988).
- Key, S.W. HONDO – A Finite Element Computer Program for the Large Deformation Dynamic Response of Axisymmetric Solids, Sandia National Laboratories, Albuquerque, N.M., Rept. 74-0039 (1974).
- Kolling, S., Haufe, A., Feucht, M., DuBois, P. A. "SAMP-1: A Semi-Analytical Model for the Simulation of Polymers", 4. LS-DYNA Anwenderforum, October 20-21, Bamberg, Germany, (2005).
- Kolling, S., Hirth, A., Erhart, and Du Bois P.A., Private Communication, Livermore, California (2006).
- Krieg, R.D., A Simple Constitutive Description for Cellular Concrete, Sandia National Laboratories, Albuquerque, NM, Rept. SC-DR-72-0883 (1972).
- Krieg, R.D. and S.W. Key, "Implementation of a Time Dependent Plasticity Theory into Structural Computer Programs," Vol. 20 of Constitutive Equations in Viscoplasticity: Computational and Engineering Aspects (American Society of Mechanical Engineers, New York, N.Y., pp. 125-137 (1976).

## REFERENCES

---

- Lademo, O.G., Berstad, T., Tryland, T., Furu, T., Hopperstad, O.S. and Langseth, M., "A model for process-based crash simulation", 8<sup>th</sup> International LS-DYNA User's Conference, Detroit, May 3-5, 2004.
- Lademo, O.G., Hopperstad, O.S., Berstad, T. and Langseth M., "Prediction of Plastic Instability in Extruded Aluminum Alloys Using Shell Analysis and a Coupled Model of Elastoplasticity and Damage," Journal of Materials Processing Technology, 2002 (Article in Press).
- Lademo, O.G., Hopperstad, O.S., Malo, K.A. and Pedersen, K.O., "Modelling of Plastic Anisotropy in Heat-Treated Aluminum Extrusions", Journal of Materials Processing Technology **125-126**, pp. 84-88 (2002).
- Lee, E.L. and C.M. Tarver, "Phenomenological Model of Shock Initiation in Heterogenous Explosives," PHYS. Fluids, Vol. 23, p. 2362 (1980).
- Lemaitre, J., A Course on Damage Mechanics, Springer-Verlag, (1992).
- Lemaitre, J., and Chaboche, J.L., Mechanics of Solid Materials, Cambridge University Press, (1990).
- Lemmen, P. P. M. and Meijer, G. J., "Failure Prediction Tool Theory and User Manual," TNO Report 2000-CMC-R0018, (2001).
- Lewis, B.A., "Developing and Implementing a Road Side Safety Soil Model into LS-DYNA," FHWA Research and Development Turner-Fairbank Highway Research Center, (1999).
- Li, Y.H. and Sellars, C.M., "Modeling Deformation Behavior of Oxide Scales and their Effects on Interfacial Heat Transfer and Friction during Hot Steel Rolling", Proc. Of the 2<sup>nd</sup> Int. Conf. Modeling of Metals Rolling Processes, The Insitute of Materials, Londong, UK, 192-201 (1996).
- Lian, W., Memo entitled: "LS-DYNA Airbag Module Improvement Request", General Motors Corporation (2000).
- Y. Luo, "An Efficient 3D Timoshenko Beam Element with Consistent Shape Functions" Adv. Theor. Appl. Mech., 1(3), 95-106, (2008).
- MADYMO3D USER'S MANUAL, Version 4.3, TNO Road-Vehicles Research Institute, Department of Injury Prevention, The Hague, The Netherlands, (1990).
- Maker, B.N., Private communication Lawrence Livermore National Laboratory, Dr. Maker programmed and implemented the compressible Mooney Rivlin rubber model (1987).
- Makris N. and Zhang, J., "Time-domain visco-elastic analysis of earth structures," Earthquake Engineering and Structural Dynamics, vol. 29, pp. 745-768, (2000).
- Malvar, L.J., Crawford, J.E., Morrill, K.B., K&C Concrete Material Model Release III — Automated Generation of Material Model Input, K&C Technical Report TR-99-24-B1, 18 August 2000 (Limited Distribution).



## REFERENCES

---

- Malvar, L.J., Crawford, J.E., Wesevich, J.W., Simons, D., “A Plasticity Concrete Material Model for DYNA3D,” *International Journal of Impact Engineering*, Volume 19, Numbers 9/10, pages 847-873, December 1997.
- Malvar, L.J., and Ross, C.A., “Review of Static and Dynamic Properties of Concrete in Tension,” *ACI Materials Journal*, Volume 95, Number 6, pages 735-739, November-December 1998.
- Malvar, L.J., and Simons, D., “Concrete Material Modeling in Explicit Computations,” *Proceedings, Workshop on Recent Advances in Computational Structural Dynamics and High Performance Computing*, USAE Waterways Experiment Station, Vicksburg, MS, pages 165-194, April 1996. (LSTC may provide this reference upon request.)
- Malvar, H.S., Sullivan, G.S., and Wornell, G.W., “Lapped Orthogonal Vector Quantization”, in *Proc. Data Compression Conference*, Snowbird, Utah, 1996.
- Marin, E.B., unpublished paper, Sandia National Laboratory, CA (2005).
- Matzenmiller, A., Lubliner, J., and Taylor, R.L., “A Constitutive Model for Anisotropic Damage in Fiber-Composites,” *Mechanics of Materials*, Vol. 20, pp. 125-152 (1995).
- Matzenmiller, A. and J. K. Schweizerhof, “Crashworthiness Considerations of Composite Structures – A First Step with Explicit Time Integration in Nonlinear Computational Mechanics–State-of-the-Art,” Ed. P. Wriggers, W. Wagner, Springer Verlag, (1991).
- Mauldin, P.J., R.F. Davidson, and R.J. Henninger, “Implementation and Assessment of the Mechanical-Threshold-Stress Model Using the EPIC2 and PINON Computer Codes,” Report LA-11895-MS, Los Alamos National Laboratory (1990).
- McCormick, P.G., “Theory of flow localization due to dynamic strain ageing,” *Acta Metallurgica*, 36, 3061-3067 (1988).
- Mi Y., Crisfield, M.A., Davies, A.O. Progressive delamination using interface elements. *J Compos Mater*, 32(14)1246-72 (1998).
- Moran, B., Ortiz, M. and Shih, C.F., “Formulation of implicit finite element methods for multiplicative finite deformation plasticity”. *Int J for Num Methods in Engineering*, 29, 483-514 (1990).
- de Moura MFSF, Gonçalves, J.P., Marques, A.T., and de Castro, P.T., Elemento finito isoparamétrico de interface para problemas tridimensionais. *Revista Internacional de Métodos Numéricos Para Cálculo e Design en Ingeniería*, 14:447-66 (1996).
- Murray, Y.D., Users Manual for Transversely Isotropic Wood Model APTEK, Inc., Technical Report to the FHWA (to be published) (2002).
- Murray, Y.D. and Lewis, B.A., Numerical Simulation of Damage in Concrete APTEK, Inc., Technical Report DNA-TR-94-190, Contract DNA 001-91-C-0075, Defense Nuclear Agency, Alexandria VA 22310.

## REFERENCES

---

- Murray, Y.D., Users Manual for LS-DYNA Concrete Material Model 159, Report No. FHWA-HRT-05-062, Federal Highway Administration, (2007).
- Murray, Y.D., A. Abu-Odeh, and R. Bligh, Evaluation of Concrete Material Model 159, Report No. FHWA-HRT-05-063, Federal Highway Administration, (2007).
- Muscolini, G., Palmeri, A. and Ricciardelli, F., “Time-domain response of linear hysteretic systems to deterministic and random excitations,” *Earthquake Engineering and Structural Dynamics*, vol. 34, pp. 1129–1147, (2005).
- Nagararajah, Reinhorn, & Constantinou, “Nonlinear Dynamic Analysis of 3-D Base-Isolated Structures”, *Journal of Structural Engineering* Vol 117, No 7, (1991).
- Nahshon, K. and Hutchinson, J.W., “Modification of the Gurson Model for shear failure”, *European Journal of Mechanics A/Solids*, Vol. 27, 1-17, (2008).
- Neal, M.O., C-H Lin, and J. T. Wang, “Aliasing Effects on Nodal Acceleration Output from Nonlinear Finite Element Simulations,” ASME 2000 International Mechanical Engineering Congress and Exposition, Orlando, Florida, November 5-10, (2000).
- Neilsen, M.K., H.S. Morgan, and R.D. Krieg, “A Phenomenological Constitutive Model for Low Density Polyurethane Foams,” Rept. SAND86-2927, Sandia National Laboratories, Albuquerque, N.M., (1987).
- Nusholtz, G., W. Fong, and J. Wu, "Air Bag Wind Blast Phenomena Evaluation," *Experimental Techniques*, Nov.-Dec. (1991).
- Nusholtz, G., D. Wang, and E.B. Wylie, "Air Bag Momentum Force Including Aspiration," Preprint, Chrysler Corporation, (1996).
- Nusholz, private communication, (1996).
- Ogden, R.W., Non-Linear Elastic Deformations, Ellis Horwood Ltd., Chichester, Great Britain (1984).
- Oliver, J., “A Consistent Characteristic Length of Smearred Cracking Models,” *International Journal for Numerical Methods in Engineering*, **28**, 461-474 (1989).
- Papadrakakis, M., “A Method for the Automatic Evaluation of the Dynamic Relaxation Parameters,” *Comp. Meth. Appl. Mech. Eng.*, Vol. 25, pp. 35-48 (1981).
- Park, R. and Paulay, T., (1975) Reinforced Concrete Structures, J. Wiley and Sons, New York.
- Park, Y.J., Wen, Y.K, and Ang, A.H-S, "Random Vibration of Hysteretic Systems Under Bi-directional Ground Motions", *Earthquake Engineering and Structural Dynamics*, Vol. 14, pp. 543-557 (1986).
- Penelis, G.G. and Kappos, A.J., Earthquake-Resistant Concrete Structures, E&FN Spon., (1997).

## REFERENCES

---

- Pijaudier-Cabot, G., and Bazant, Z.P., "Nonlocal Damage Theory," *Journal of Engineering Mechanics*, ASCE, Vol. 113, No. 10, 1512-1533 (1987).
- Porcaro, R., A.G. Hanssen, A. Aalberg and M. Langseth, "The behaviour of a self-piercing riveted connection under quasi-static loading conditions," *Int. J. Solids and Structures*, Vol. 43/17, pp. 5110-5131 (2006).
- Porcaro, R., A.G. Hanssen, A. Aalberg and M. Langseth, "Self-piercing riveting process, an experimental and numerical investigation," *Journal of Materials processing Technology*, Vol. 171/1, pp. 10-20 (2006).
- Porcaro, R., M. Langseth, A.G. Hanssen, H. Zhao, S. Weyer and H. Hooputra, "Crashworthiness of self-piercing riveted connections," *International Journal of Impact Engineering*, In press, Accepted manuscript (2007).
- Puso, M.A., "A Highly Efficient Enhanced Assumed Strain Physically Stabilized Hexahedral Element", *Int. J. Numer. Meth. Eng.*, Vol. 49, 1029-1064 (2000).
- Puso, M.A. and Weiss, J.A., "Finite Element Implementation of Anisotropic Quasilinear Viscoelasticity Using a Discrete Spectrum Approximation", *ASME J. Biomech. Engng.*, 120, 62-70 (1998).
- Pelessone, D., Private communication, GA Technologies, P.O. Box 85608, San Diego, CA., Telephone No. 619-455-2501 (1986).
- Quapp, K.M. and Weiss, J.A., "Material Characterization of Human Medial Collateral Ligament", *ASME J. Biomech Engng.*, 120, 757-763 (1998).
- Reyes, A., O.S. Hopperstad, T. Berstad, and M. Langseth, Implementation of a Material Model for Aluminium Foam in LS-DYNA, Report R-01-02, Restricted, Department of Structural Engineering, Norwegian University of Science and Technology, (2002).
- Randers-Pehrson, G. and K. A. Bannister, Airblast Loading Model for DYNA2D and DYNA3D, Army Research Laboratory, Rept. ARL-TR-1310, publicly released with unlimited distribution, (1997).
- Richards, G.T., Derivation of a Generalized Von Neuman Pseudo-Viscosity with Directional Properties, University of California, Lawrence Livermore National Laboratory, Rept. UCRL-14244 (1965).
- Riedel W., Thoma K., Hiermaier S. and Schmolinske E., "Penetration of reinforced concrete by BETA-B-500", in Proc. 9. ISIEMS, Berlin Strausberg, Mai (1999).
- Riedel W., "Beton unter Dynamischen Lasten – Meso- und Makromechanische Modelle" In: Ernst-Mach-Institut, editor. Freiburg: Fraunhofer IRB, ISBN 3-8167-6340-5; 2004.
- Roussis, P.C., and Constantinou, M.C., "Uplift-restraining Friction Pendulum seismic isolation system", *Earthquake Engineering and Structural Dynamics*, 35 (5), 577-593, (2006).

## REFERENCES

---

- Rupp, A., Grubisic, V., and Buxbaum, O., Ermittlung ertragbarer Beanspruchungen am Schweißpunkt auf Basis der übertragbaren Schnittgrößen, FAT Schriftenreihe 111, Frankfurt (1994).
- Sala, M.O. Neal, and J.T. Wang, Private Communication, General Motors, May, 2004.
- Sackett, S.J., "Geological/Concrete Model Development," Private Communication (1987).
- Sandler, I.S. and D. Rubin, "An Algorithm and a Modular Subroutine for the Cap Model," Int. J. Numer. Anal. Meth. Geomech., 3, pp. 173-186 (1979).
- Schedin, E., Prentzas, L. and Hilding D., "Finite Element Simulation of the TRIP-effect in Austenitic Stainless Steel," presented at SAE 2004, SAE Technical paper 2004-01-0885, (2004).
- Schwer, L.E., "A Viscoplastic Augmentation of the Smooth Cap Model," Nuclear Engineering and Design, Vol. 150, pp. 215-223, (1994).
- Schwer, L.E., "Demonstration of the Continuous Surface Cap Model with Damage: Concrete Unconfined Compression Test Calibration," LS-DYNA Geomaterial Modeling Short Course Notes, July (2001).
- Schwer, L.E., W. Cheva, and J.O. Hallquist, "A Simple Viscoelastic Model for Energy Absorbers Used in Vehicle-Barrier Impact," in Computation Aspects of Contact, Impact, and Penetration, Edited by R.F. Kulak and L.E. Schwer, Elsevier International, Lausanne, Switzerland, pp. 99-117 (1991).
- Schwer, L.E. and Y.D. Murray, "A Three-Invariant Smooth Cap Model with Mixed Hardening," International Journal for Numerical and Analytical Methods in Geomechanics, Volume 18, pp. 657-688, (1994).
- Seeger, F., M. Feucht, T. Frank (DaimlerChrysler AG), and A. Haufe, B. Keding (DYNAmore GmbH), "An Investigation on Spotweld Modeling for Crash Simulation with LS-DYNA", 4<sup>th</sup> LS-DYNA-Forum, Bamberg, Germany, October (2005), ISBN 3-9809901-1-7.
- Sheppard, S.D., Estimations of Fatigue Propagation Life in Resistance Spot Welds, ASTM STP 1211, pp. 169-185, (1993).
- Sheppard, T. and Wright, D.S., "Determination of flow stress: Part 1 constitutive equation for aluminum alloys at elevated temperatures", Metals Technology, p. 215, June 1979.
- Shvets, I.T. and Dyban, E., P., "Contact Heat Transfer between Plane Metal Surfaces", Int. Chem. Eng., Vol. 4, No. 4, 621 (1964).
- Simo, J.C., J.W. Ju, K.S. Pister, and R.L. Taylor, "An Assessment of the Cap Model: Consistent Return Algorithms and Rate-Dependent Extension," J. Eng. Mech., Vol. 114, No. 2, 191-218 (1988a).

## REFERENCES

---

- Simo, J.C., J.W. Ju, K.S. Pister, and R.L. Taylor, "Softening Response, Completeness Condition, and Numerical Algorithms for the Cap Model," *Int. J. Numer. Anal. Meth. Eng.*, (in press) (1988b).
- Simo, J. C., J.W. Ju, K.S. Pister, and R.L. Taylor, "Softening Response, Completeness Condition, and Numerical Algorithms for the Cap Model," *Int. J. Numer. Anal. Meth. Eng.* (1990).
- Solberg, J.M., and C.M. Noble, "Contact Algorithm for Small-Scale Surface Features with Application to Finite Element Analysis of Concrete Arch Dams with Beveled Contraction Joints", Lawrence Livermore National Laboratory (2002).
- Spanos, P.D. and Tsavachidis, S., "Deterministic and stochastic analyses of a nonlinear system with a Biot visco-elastic element," *Earthquake Engineering and Structural Dynamics*, vol. 30, pp. 595–612, (2001).
- Steinberg, D.J. and M.W. Guinan, A High-Strain-Rate Constitutive Model for Metals, University of California, Lawrence Livermore National Laboratory, Rept. UCRL-80465 (1978).
- Steinberg, D.J. and C.M. Lund, "A Constitutive Model for Strain Rates from  $10^{-4}$  to  $10^6$  S<sup>-1</sup>," *J. Appl. Phys.*, 65, p. 1528 (1989).
- Stillman, D.W. and J.O. Hallquist, INGRID: A Three-Dimensional Mesh Generator for Modeling Nonlinear Systems, University of California, Lawrence Livermore National Laboratory, Rept. UCID-20506. (1985).
- Stojko, S., private communication, NNC Limited, Engineering Development Center (1990).
- Storakers, B., "On material representation and constitutive branching in finite compressible elasticity", *J. Mech. Phy. Solids*, 34 No. 2, 125-145 (1986).
- Stouffer and Dame, *Inelastic Deformation of Metals*, Wiley, (1996).
- Stout, M.G., D.E. Helling, T.L. Martin, and G.R. Canova, *Int. J. Plasticity*, Vol. 1, pp. 163-174, (1985).
- Structural Engineers Association of California, Tentative Lateral Force Requirements, Seismology Committee, SEAOC, 1974, 1990, 1996.
- Sussman, T. and Bathe, K.J., "A Finite Element Formulation for Nonlinear Incompressible Elastic and Inelastic Analysis," *Computers & Structures*, **26**, Number 1/2, 357-409 (1987).
- Tabiei, A. and I. Ivanov, "Computational micro-mechanical Model of Flexible Woven Fabric for Finite Element Impact Simulation," *IJNME*, 53, (6), 1259-1276, (2002).
- Tahoe User Guide, Sandia National Laboratory, can be downloaded from: [www.sandia.gov](http://www.sandia.gov), Input version 3.4.1, (2003).

## REFERENCES

---

- Taylor, L.M. and D.P. Flanagan, PRONTO3D A Three-Dimensional Transient Solid Dynamics Program, Sandia Report: SAND87-1912, UC-32, (1989).
- Taylor, R.L. Finite element analysis of linear shell problems, in Whiteman, J.R. (ed.), Proceedings of the Mathematics in Finite Elements and Applications, Academic Press, New York, 191-203, (1987).
- Taylor, R.L. and Simo, J.C. Bending and membrane elements for the analysis of thick and thin shells, Proc. of NUMETA Conference, Swansea (1985).
- Tsai, S.W. and E.M. Wu, "A General Theory of Strength for Anisotropic Materials," J. Composite Materials, 5, pp. 73-96 (1971).
- Tuler, F.R. and B.M. Butcher, "A Criterion for the Time Dependence of Dynamic Fracture," The International Journal of Fracture Mechanics, Vol. 4, No. 4, (1968).
- Tvergaard, V. and J.W. Hutchinson, "The relation between crack growth resistance and fracture process parameters in elastic-plastic solids," J. of the Mech. And Phy. of Solids, 40, pp1377-1397, (1992)
- Tvergaard, V. and Needleman, A., "Analysis of the cup-cone fracture in a round tensile bar", Acta Metallurgica, 32, 157-169 (1984).
- Vawter, D., "A Finite Element Model for Macroscopic Deformation of the Lung," published in the Journal of Biomechanical Engineering, Vol.102, pp. 1-7 (1980).
- VDA Richtlinier (Surface Interfaces), Version 20, Verband der Automobilindustrie e.v., Frankfurt, Main, Germany, (1987).
- Vegter, H., and Boogaard, A.H. van den, "A plane stress yield function for anisotropic sheet material by interpolation of biaxial stress states", International Journal of Plasticity 22, 557-580 (2006).
- Walker, J.C., Ratcliffe M.B., Zhang P., Wallace A.W., Fata, B., Hsu E., Saloner D., and Guccione J.M. "MRI-based finite-element analysis of left ventricular aneurysm", Am J Physiol Heart Circ Physiol 289(2): H692:700 (2005).
- Wang, J.T. and O.J. Nefske, "A New CAL3D Airbag Inflation Model," SAE paper 880654, 1988.
- Wang, J.T., "An Analytical Model for an Airbag with a Hybrid Inflator", Publication R&D 8332, General Motors Development Center, Warren, Mi. (1995).
- Wang, J.T., "An Analytical Model for an Airbag with a Hybrid Inflator", AMD-Vol. 210, BED-Vol. 30, ASME, pp 467-497, (1995).
- Weiss, J.A., Maker, B.N. and Govindjee, S., "Finite Element Implementation of Incompressible, Transversely Isotropic Hyperelasticity", Comp. Meth. Appl. Mech. Eng., 135, 107-128 (1996).

## REFERENCES

---

- Wen, T.K. "Method for Random Vibration of Hysteretic Systems", J. Engrg. Mech., ASCE, Vol. 102, No. EM2, Proc. Paper 12073, pp.249-263 (1976).
- Whirley, R. G., and J. O. Hallquist, DYNA3D, A Nonlinear, Explicit, Three-Dimensional Finite Element Code for Solid and Structural Mechanics-Users Manual, Report No.UCRL-MA-107254 , Lawrence Livermore National Laboratory, (1991).
- Whirley, R. G., and G.A. Henshall, "Creep Deformation Structural Analysis Using An Efficient Numerical Algorithm," IJNME, Vol. 35, pp. 1427-1442, (1992).
- Wilkins, M.L., "Calculations of Elastic Plastic Flow," Meth. Comp. Phys., **3**, (Academic Press), 211-263 (1964).
- Wilkins, M.L., Calculation of Elastic-Plastic Flow, University of California, Lawrence Livermore National Laboratory, Rept. UCRL-7322, Rev. I (1969).
- Wilkins, M.L., The Use of Artificial Viscosity in Multidimensional Fluid Dynamics Calculations, University of California, Lawrence Livermore National Laboratory, Rept. UCRL-78348 (1976)
- Wilkins, M.L., R.E. Blum, E. Cronshagen, and P. Grantham, A Method for Computer Simulation of Problems in Solid Mechanics and Gas Dynamics in Three Dimensions and Time, University of California, Lawrence Livermore National Laboratory, Rept. UCRL-51574 (1974).
- Wilkins, M.L., J.E. Reaugh, B. Moran, J.K. Scudder, D.F. Quinones, M.E. Prado, Fundamental Study of Crack Initiation and Propagation Annual Progress Report, Report UCRL-52296, Lawrence Livermore National Laboratory, Livermore, CA. (1977).
- Williams K. V., Vaziri R., Poursartip A., "A Physically Based Continuum Damage Mechanics Model for Thin Laminated Composite Structures." Int J Solids Struct, Vol 40(9), 2267-2300
- Wilson, E.L. Three Dimensional Static and Dynamic Analysis of Structures, Computers and Structures, Inc., Berkeley CA, (2000).
- Winters, J.M., "Hill-based muscle models: A systems engineering perspective," In Multiple Muscle Systems: Biomechanics and Movement Organization, JM Winters and SL-Y Woo eds, Springer-Verlag (1990).
- Winters J.M. and Stark L., "Estimated mechanical properties of synergistic muscles involved in movements of a variety of human joints," J Biomechanics 21:1027-1042, (1988).
- Woodruff, J.P., KOVEC User's Manual, University of California, Lawrence Livermore National Laboratory, Report UCRL-51079, (1973).
- Worswick, M.J., and Xavier Lalbin, Private communication, Livermore, California, (1999).

## REFERENCES

---

- Yamasaki, H., M. Ogura, R. Nishimura, and K. Nakamura, "Development of Material Model for Crack Propagation of Casting Aluminum", Presented at the 2006 JSAE Annual Congress, Paper Number 20065077, (2006).
- Yen, C.F., "Ballistic Impact Modeling of Composite Materials," Proceedings of the 7<sup>th</sup> International LS-DYNA Users Conference, Dearborn, MI, May 19-21, 2002, 6.15-6.25.
- Yoshida, F. and Uemori, T., "A Model of Large-Strain Cyclic Plasticity and its Application to Springback Simulation," *International Journal of Mechanical Sciences*, Vol. 45, 1687-1702, (2003).
- Zajac F.E., "Muscle and tendon: Properties, models, scaling, and application to biomechanics and motor control", *CRC Critical Reviews in Biomedical Engineering* 17(4):359-411, (1989).
- Zayas, V.A., Low, S.S. and Mahin, S.A., "A Simple Pendulum Technique for Achieving Seismic Isolation", *J. Earthquake Spectra*, Vol. 6, No. 2, pp. 317-334 (1990).
- Zhang, S., Approximate Stress Intensity Factors and Notch Stresses for Common Spot-Welded Specimens, *Welding Research Supplement*, pp. 173s-179s, (1999).
- Zhang, S., McCormick, P.G., Estrin, Y., "The morphology of Portevin-Le Chatelier bands: Finite element simulation for Al-Mg-Si", *Acta Materialia* 49, 1087-1094, (2001).



## APPENDIX A: User Defined Materials

The user can supply his/her own subroutines defining material models in LS-DYNA. To invoke a user-defined material, one must

1. Write a user material subroutine that is called by the LS-DYNA user material interface.
2. Create a custom executable which includes the material subroutine.
3. Invoke that subroutine by defining a part in the keyword input deck that uses `*MAT_USER_DEFINED_MATERIAL_MODELS` with appropriate input parameters.

All subroutines, including interface, for the user-defined materials are collected in the file `dyn21.F` (Unix/Linux) or `lsdyna.f` (Windows). Up to ten user subroutines can currently be implemented simultaneously to update the stresses in solids, shells, beams, discrete beams and truss beams. This text serves as an introductory guide to implement such a model. Note that names of variables and subroutines below may differ from the actual ones depending on platform and current version of LS-DYNA.

### General overview

When the keyword `*MAT_USER_DEFINED_MATERIAL_MODELS` is defined for a part in the keyword deck, LS-DYNA calls the subroutine `usrmat` with appropriate input data for the constitutive update. This routine in turn calls `urmathn` for 2D and 3D solid elements, `urmats` for 2D plane stress and 3D shell elements, `urmatb` for beam elements, `urmatd` for discrete beam elements and `urmatt` for truss beam elements. In these routines, which may be modified by the user if necessary, the following data structures are initialized for the purpose of being supplied to a specific scalar material subroutine.

`sig(6)` - stresses in previous time step  
`eps(6)` - strain increments  
`epsp` - effective plastic strain in previous time step  
`hsv(*)` - history variables in previous time step excluding plastic strain  
`dt1` - current time step size  
`temper` - current temperature  
`failel` - flag indicating failure of element

If the vectorization flag is active (`IVECT=1`) on the material card, variables are in general stored in vector blocks of length `nlq`, with vector indexes ranging from `lft` to `llt`, which allows for a more efficient execution of the material routine. As an example, the data structures mentioned above are for the vectorized case exchanged for

`sigX(nlq)` - stresses in previous time step  
`dX(nlq)` - strain increments  
`epsps(nlq)` - effective plastic strains in previous time step  
`hsvs(nlq,*)` - history variables in previous time step  
`dtlsiz(nlq)` - current time step sizes  
`temps(nlq)` - current temperatures

# APPENDIX A

---

`failels(nlq)` - flags indicating failure of elements

where  $X$  ranges from 1 to 6 for the different components. Each entry in a vector block is associated with an integration point in the finite element mesh.

The number of entries in the history variables array (indicated by  $*$  in the above) matches the number of history variables requested on the material card (`NHV`). Hence the number `NHV` should equal to the number of history variables excluding the effective plastic strain since this variable is given a special treatment. All history variables, including the effective plastic strain, are initially zero. Furthermore, all user-defined material models require a bulk modulus and shear modulus for transmitting boundaries, contact interfaces, rigid body constraints, and time step calculations. This generally means that the length of material constants array `LMC` must be increased by 2 for the storage of these parameters. In addition to the variables mentioned above, the following data can be supplied to the user material routines, regardless of whether vectorization is used or not.

`cm(*)` - material constants array  
`capa` - transverse shear correction factor for shell elements  
`tt` - current time  
`crv(101,2,*)` - array representation of curves defined in the keyword deck

A specific material routine, `umatXX` in the scalar case or `umatXXv` in the vector case, is now called with any necessary parameters of the ones above, and possibly others as well. The letters `XX` stands for a number between 41 and 50 and matches the number `MT` on the material card. This subroutine is written by the user, and should update the stresses and history variables to the current time. For shells and beams it is also necessary to determine the strain increments in the directions of constrained zero stress. To be able to write different stress updates for different elements, the following character string is passed to the user-defined subroutine

`etype` - character string that equals `solid, shell, beam, dbeam` or `tbeam`

A sample user subroutine of a hypo-elastic material in the scalar case is provided below.

## Sample user subroutine 41

```
      subroutine umat41 (cm,eps,sig,eps,hsv,dtl,capa,etype,
      .      tt,temper,failel,crv)
c*****
c|  livermore software technology corporation  (lstc)          |
c|  -----
c|  copyright 1987-2003                                     |
c|  all rights reserved                                     |
c*****
c
c   Isotropic elastic material (sample user subroutine)
c
c   Variables
c
c   cm(1)=first material constant, here young's modulus
c   cm(2)=second material constant, here poisson's ratio
```

```
c      .
c      .
c      .
c      cm(n)=nth material constant
c
c      eps(1)=local x  strain increment
c      eps(2)=local y  strain increment
c      eps(3)=local z  strain increment
c      eps(4)=local xy strain increment
c      eps(5)=local yz strain increment
c      eps(6)=local zx strain increment
c
c      sig(1)=local x  stress
c      sig(2)=local y  stress
c      sig(3)=local z  stress
c      sig(4)=local xy stress
c      sig(5)=local yz stress
c      sig(6)=local zx stress
c
c      epsp=effective plastic strain
c
c      hsv(1)=1st history variable
c      hsv(2)=2nd history variable
c      .
c      .
c      .
c      .
c      hsv(n)=nth history variable
c
c      capa=reduction factor for transverse shear
c
c      etype:
c      eq."brick" for solid elements
c      eq."shell" for all shell elements
c      eq."beam"  for all beam elements
c      eq."dbeam" for all discrete beam elements
c
c      temper=current temperature
c
c      dt1=current time step size
c
c      tt=current problem time.
c
c      crv=array representation of curves defined in keyword deck
c
c      failfl=flag for failure, set to .true. to fail an element
c
c      All transformations into the element local system are
c      performed prior to entering this subroutine. Transformations
c      back to the global system are performed after exiting this
c      routine.
c
c      All history variables are initialized to zero in the input
c      phase. Initialization of history variables to nonzero values
c      may be done during the first call to this subroutine for each
c      element.
c
```

# APPENDIX A

---

```
c      Energy calculations for the energy balance are done
c      outside this subroutine.
c
c      character*(*) etype
c      dimension  cm(*),eps(*),sig(*),hsv(*),crv(101,2,*)
c      logical fail1
c
c      compute shear modulus, g
c      g2 =cm(1)/(1.+cm(2))
c      g  =.5*g2
c
c      if (etype.eq.'brick') then
c
c          davg=(-eps(1)-eps(2)-eps(3))/3.
c          p=-davg*cm(1)/((1.-2.*cm(2)))
c          sig(1)=sig(1)+p+g2*(eps(1)+davg)
c          sig(2)=sig(2)+p+g2*(eps(2)+davg)
c          sig(3)=sig(3)+p+g2*(eps(3)+davg)
c          sig(4)=sig(4)+g*eps(4)
c          sig(5)=sig(5)+g*eps(5)
c          sig(6)=sig(6)+g*eps(6)
c
c      elseif (etype.eq.'shell') then
c
c          gc      =capa*g
c          q1      =cm(1)*cm(2)/((1.0+cm(2))*(1.0-2.0*cm(2)))
c          q3      =1./(q1+g2)
c          eps(3)  =-q1*(eps(1)+eps(2))*q3
c          davg    =(-eps(1)-eps(2)-eps(3))/3.
c          p      =-davg*cm(1)/((1.-2.*cm(2)))
c          sig(1)  =sig(1)+p+g2*(eps(1)+davg)
c          sig(2)  =sig(2)+p+g2*(eps(2)+davg)
c          sig(3)  =0.0
c          sig(4)  =sig(4)+g *eps(4)
c          sig(5)  =sig(5)+gc*eps(5)
c          sig(6)  =sig(6)+gc*eps(6)
c
c      elseif (etype.eq.'beam' ) then
c
c          q1      =cm(1)*cm(2)/((1.0+cm(2))*(1.0-2.0*cm(2)))
c          q3      =q1+2.0*g
c          gc      =capa*g
c          deti    =1./(q3*q3-q1*q1)
c          c22i    = q3*deti
c          c23i    =-q1*deti
c          fac     =(c22i+c23i)*q1
c          eps(2)  =-eps(1)*fac-sig(2)*c22i-sig(3)*c23i
c          eps(3)  =-eps(1)*fac-sig(2)*c23i-sig(3)*c22i
c          davg    =(-eps(1)-eps(2)-eps(3))/3.
c          p      =-davg*cm(1)/((1.-2.*cm(2)))
c          sig(1)  =sig(1)+p+g2*(eps(1)+davg)
c          sig(2)  =0.0
c          sig(3)  =0.0
c          sig(4)  =sig(4)+gc*eps(4)
c          sig(5)  =0.0
c          sig(6)  =sig(6)+gc*eps(6)
```

```

elseif (etype.eq.'tbeam' ) then
c
    q1      =cm(1)*cm(2)/((1.0+cm(2))*(1.0-2.0*cm(2)))
    q3      =q1+2.0*g
    deti    =1./(q3*q3-q1*q1)
    c22i    = q3*deti
    c23i    =-q1*deti
    fac     =(c22i+c23i)*q1
    eps(2)  =-eps(1)*fac
    eps(3)  =-eps(1)*fac
    davg    =(-eps(1)-eps(2)-eps(3))/3.
    p       =-davg*cm(1)/((1.-2.*cm(2)))
    sig(1)  =sig(1)+p+g2*(eps(1)+davg)
    sig(2)  =0.0
    sig(3)  =0.0
endif
c
return
end

```

## Additional features

### Load curves and tables

If the material of interest should require load curves, for instance a curve defining yield stress as a function of effective plastic strain, the variable `crv` should be used. Each curve defined in the keyword deck is represented by points  $(x_i, y_i)$ ,  $i = 1, \dots, 100$ , stored in the array `crv` together with a number defining the increments  $\Delta x$  stored in position 101. To be more precise, the first  $x$  value is stored in `crv(1,1,*)`, the first  $y$  value in `crv(1,2,*)`, the second  $x$  value in `crv(2,1,*)`, the second  $y$  value in `crv(2,2,*)`, and so on. The increment  $\Delta x$  is stored in `crv(101,1,*)`. The third index in the `crv` array represents the internal load curve id. There are two ways to extract the values from a load curve from a user defined materials routine.

First, there are two subroutines that can be called from within the user defined routine, these are

```
subroutine crvval(crv,eid,xval,yval,slope)
```

and

```
subroutine crvval_v(crv,eid,xval,yval,slope,lft,llt)
```

where the former routine is used in the scalar context and the latter for vectorized `umat`. The arguments are the following

```

crv    - the load curve array
eid    - external load curve ID, i.e., the load curve ID taken from the keyword deck
xval   - abscissa value
yval   - ordinate value (output from routine)
slope  - slope of curve (output from routine)
lft    - first index of vector
llt    - final index of vector

```

## APPENDIX A

---

where `xval`, `yval` and `slope` are scalars in the scalar routine and vectors of length `n1q` in the vectorized routine. Note that `eid` should be passed as float.

Second, for efficiency considerations the user may extract values on his/her own. The following few lines of code shows how to extract the ordinate value `y` at the abscissa `x` for a curve with external curve id (in the keyword deck) given by `crvid_ext`.

```
      integer crvid_int
c
c      obtain internal curve id
c
c      crvid_int=lcids(nint(crvid_ext))
c
c      proceed if curve id is valid
c
c      if (crvid_int.gt.0) then
c
c      obtain increment in x and first x value
c
c      xinc=crv(101,1,crvid_int)
c      xbg=crv(1,1,crvid_int)
c
c      find interval in which x is situated
c
c      ind=aint((x-xbg)/xinc)+1
c      ind=min(ind,99)
c      ind=max(ind,1)
c
c      find slope of that particular segment
c
c      slope=(crv(ind+1,2,crvid_int)-crv(ind,2,crvid_int))/
1      (crv(ind+1,1,crvid_int)-crv(ind,1,crvid_int))
c
c      evaluate ordinate value y
c
c      y=crv(ind,2,crvid_int)+slope*(x-crv(ind,1,crvid_int))
c
c      endif
```

For tables, two subroutines are available for extracting values. A scalar version is

```
      subroutine tabval(crv,eid,dxval,yval,dslope,xval,slope)
```

and a vector version is

```
      subroutine tabval_v(crv,eid,dxval,yval,dslope,lft,llt,xval,slope)
```

where

`crv` - curve array  
`eid` - external curve id, i.e., curve id taken from keyword deck  
`dxval` - abscissa value (x2-axis)  
`yval` - ordinate value (y-axis, output from routine)

dslope- slope of curve (dy/dx2, output from routine)  
xval - abscissa value (x1-axis)  
slope - slope of curve (dy/dx1, output from routine)  
lft - vector index  
llt - vector index

In the scalar routine, dxval, yval, dslope, xval and slope are all scalars whereas in the vector routine they are vectors of length nlq.

## Local coordinate system

If the material model has directional properties, such as composites and anisotropic plasticity models, the local coordinate system option can be invoked. This is done by putting `IORTHO` equal to 1 on the material card. This also requires two additional cards with values for how the coordinate system is formed and updated. When this option is used, all data passed to the constitutive routine `umatXX` or `umatXXv` is in the local system and the transformation back to the global system is done outside this user-defined routine. There is one exception however, see the section on the deformation gradient.

## Temperature

For a material with thermal properties, temperatures are made available by putting the flag `ITHERMAL` equal to 1 on the material card. The temperatures in the elements are then available in the `temper` variable for a scalar and `temps` array for the vectorized implementation. For a coupled thermal structural analysis, the thermal problem is solved first and temperatures at the current time are available in the user-defined subroutine. Calculation of dissipated heat in the presence of plastic deformation is taken care of by LS-DYNA and needs not be considered by the user. If the time derivative of the temperature is needed for the stress update, a history variable that contains the temperature in the previous time step should be requested. The time derivative can then be obtained by a backward finite difference estimate.

## Failure

It is possible to include failure in the material model, resulting in the deletion of elements that fulfill a certain failure criterion. To accomplish this, the flag `IFAIL` must be set to 1 on the material card. For a scalar implementation, the variable `failel` is set to `.true.` when a failure criterion is met. For a vectorized implementation, the corresponding entry in the `failels` array is set to `.true.`

## Deformation gradient

For some materials, the stresses are not obtained from incremental strains, but are expressed in terms of the deformation gradient  $\mathbf{F}$ . This is the case for hyper-elastic(-plastic) materials. To make the deformation gradient available for bricks and shells in the user-defined material subroutines, the variable `IHYPER` on the material card should be set to 1. The deformation gradient components  $F_{11}$ ,  $F_{21}$ ,  $F_{31}$ ,  $F_{12}$ ,  $F_{22}$ ,  $F_{32}$ ,  $F_{13}$ ,  $F_{23}$  and  $F_{33}$  can then be found in the history variables array in positions `NHV+1` to `NHV+9`, i.e., the positions coming right after the requested number of history variables.

For shell elements, the components of the deformation gradient are with respect to the co-rotational system for the element currently used. In this case the third row of the deformation

## APPENDIX A

---

gradient, i.e., the components  $F_{31}$ ,  $F_{32}$  and  $F_{33}$ , will not be properly updated when entering the user-defined material routine. These components depend on the thickness strain increment which in turn must be determined so that the normal stress in the shell vanishes. For a given thickness strain increment  $d3$ , these three components,  $f31$ ,  $f32$  and  $f33$ , can be determined by calling the subroutine

```
subroutine compute_f3s(f31,f32,f33,d3)
```

for a scalar implementation and

```
subroutine compute_f3(f31,f32,f33,d3,lft,llt)
```

for a vector implementation. The first four arguments are arrays of length  $nlq$  for the vector routine and scalars for the scalar routine.

For hyper-elastic materials there are push forward operations that can be called from within the user defined subroutines. These are

```
subroutine push_forward_2(sig1,sig2,sig3,sig4,sig5,sig6,  
f11,f21,f31,f12,f22,f32,f13,f23,f33,lft,llt)
```

which performs a push forward operation on the stress tensor, and the corresponding scalar routine

```
subroutine push_forward_2s(sig1,sig2,sig3,sig4,sig5,sig6,  
f11,f21,f31,f12,f22,f32,f13,f23,f33)
```

In the latter subroutine all arguments are scalars whereas the corresponding entries in the vectorized routine are vectors of length  $nlq$ . The  $sig1$  to  $sig6$  are components of the stress tensor and  $f11$  to  $f33$  are components of the deformation gradient.

If the local coordinate system option is invoked ( $IORTHO=1$ ), then the deformation gradient is transformed to this local system prior to entering the user-defined material routine according to

$$\bar{F}_{ij} = Q_{ki}^s F_{kj}$$

where  $Q_{ij}^s$  refers to a transformation between the current global and material frames. For  $IORTHO$  equal to 1 one can choose to put  $IHYPER$  equal to -1 which results in that the deformation gradient is transformed according to

$$\bar{F}_{ij} = F_{ik} Q_{kj}^r$$

where  $Q_{ij}^r$  is the transformation between the reference global and material frames. For this latter option the spatial frame remains the global one so the stresses should be expressed in this



frame of reference upon exiting the user defined routines. The suitable choice of `IHYPER` depends on the formulation of the material model.

In the following, a Neo-Hookean material is used as an example of the usage of the deformation gradient in user-defined materials. With  $\lambda$  and  $\mu$  being the Lamé parameters in the linearized theory, the strain energy density for this material is given by

$$\psi = \frac{1}{2} \lambda (\ln(\det \mathbf{F}))^2 - \mu \ln(\det \mathbf{F}) + \frac{1}{2} \mu (\text{tr}(\mathbf{F}^T \mathbf{F}) - 3)$$

meaning that the Cauchy stress can be expressed as

$$\boldsymbol{\sigma} = \frac{1}{\det \mathbf{F}} (\lambda \ln(\det \mathbf{F}) \mathbf{I} + \mu (\mathbf{F} \mathbf{F}^T - \mathbf{I})).$$

## Sample user subroutine 42

```

      subroutine umat42 (cm,eps,sig,epsp,hsv,dt1,capa,
.          etype,tt,temper,failel,crv)
c*****
c|  livermore software technology corporation  (lstc)          |
c|  -----|
c|  copyright 1987-2003                                     |
c|  all rights reserved                                     |
c*****
c
c      Neo-Hookean material (sample user subroutine)
c
c      Variables
c
c      cm(1)=first material constant, here young's modulus
c      cm(2)=second material constant, here poisson's ratio
c      .
c      .
c      .
c      cm(n)=nth material constant
c
c      eps(1)=local x  strain increment
c      eps(2)=local y  strain increment
c      eps(3)=local z  strain increment
c      eps(4)=local xy strain increment
c      eps(5)=local yz strain increment
c      eps(6)=local zx strain increment
c
c      sig(1)=local x  stress
c      sig(2)=local y  stress
c      sig(3)=local z  stress
c      sig(4)=local xy stress
c      sig(5)=local yz stress
c      sig(6)=local zx stress
c

```

## APPENDIX A

---

```
c      epsp=effective plastic strain
c
c      hsv(1)=1st history variable
c      hsv(2)=2nd history variable
c      .
c      .
c      .
c      .
c      hsv(n)=nth history variable
c
c      dtl=current time step size
c      capa=reduction factor for transverse shear
c      etype:
c          eq."brick" for solid elements
c          eq."shell" for all shell elements
c          eq."beam"  for all beam elements
c          eq."dbeam" for all discrete beam elements
c
c      tt=current problem time.
c      temper=current temperature
c
c      crv=array representation of curves defined in keyword deck
c
c      failer=flag for failure, set to .true. to fail an element
c
c      All transformations into the element local system are
c      performed prior to entering this subroutine. Transformations
c      back to the global system are performed after exiting this
c      routine.
c
c      All history variables are initialized to zero in the input
c      phase. Initialization of history variables to nonzero values
c      may be done during the first call to this subroutine for each
c      element.
c
c      Energy calculations for the energy balance are done
c      outside this subroutine.
c
c      character*(*) etype
c      dimension cm(*),eps(*),sig(*),hsv(*),crv(101,2,*)
c      logical failer
c
c      compute lame parameters
c
c      xlambd=cm(1)*cm(2)/((1.+cm(2))*(1.-2.*cm(2)))
c      xmu=.5*cm(1)/(1.+cm(2))
c
c      if (etype.eq.'brick') then
c
c      no history variables, NHV=0
c      deformation gradient stored in hsv(1),...,hsv(9)
c
c      compute jacobian
c
c          detf=hsv(1)*(hsv(5)*hsv(9)-hsv(6)*hsv(8))
1          -hsv(2)*(hsv(4)*hsv(9)-hsv(6)*hsv(7))
2          +hsv(3)*(hsv(4)*hsv(8)-hsv(5)*hsv(7))
```

```

c
c   compute left cauchy-green tensor
c
      b1=hsv(1)*hsv(1)+hsv(4)*hsv(4)+hsv(7)*hsv(7)
      b2=hsv(2)*hsv(2)+hsv(5)*hsv(5)+hsv(8)*hsv(8)
      b3=hsv(3)*hsv(3)+hsv(6)*hsv(6)+hsv(9)*hsv(9)
      b4=hsv(1)*hsv(2)+hsv(4)*hsv(5)+hsv(7)*hsv(8)
      b5=hsv(2)*hsv(3)+hsv(5)*hsv(6)+hsv(8)*hsv(9)
      b6=hsv(1)*hsv(3)+hsv(4)*hsv(6)+hsv(7)*hsv(9)
c
c   compute cauchy stress
c
      detfinv=1./detf
      dmu=xmu-xlambda*log(detf)
      sig(1)=detfinv*(xmu*b1-dmu)
      sig(2)=detfinv*(xmu*b2-dmu)
      sig(3)=detfinv*(xmu*b3-dmu)
      sig(4)=detfinv*xmu*b4
      sig(5)=detfinv*xmu*b5
      sig(6)=detfinv*xmu*b6
c
      else if (etype.eq.'shell') then
c
c       no history variables, NHV=0
c       deformation gradient stored in hsv(1),...,hsv(9)
c
c       compute part of left cauchy-green tensor
c       independent of thickness strain increment
c
      b1=hsv(1)*hsv(1)+hsv(4)*hsv(4)+hsv(7)*hsv(7)
      b2=hsv(2)*hsv(2)+hsv(5)*hsv(5)+hsv(8)*hsv(8)
      b4=hsv(1)*hsv(2)+hsv(4)*hsv(5)+hsv(7)*hsv(8)
c
c       secant iterations for zero normal stress
c
      do iter=1,5
c
c         if (iter.eq.1) then
c
c           first thickness strain increment initial guess
c           assuming Poisson's ratio different from zero
c
              eps(3)=-xlambda*(eps(1)+eps(2))/(xlambda+2.*xmu)
c
              else if (iter.eq.2) then
c
c               second thickness strain increment initial guess
c
                  sigold=sig(3)
                  epsold=eps(3)
                  eps(3)=0.
c
                  else if (abs(sig(3)-sigold).gt.0.0) then
c
c                   secant update of thickness strain increment
c
                      deps=- (eps(3)-epsold) / (sig(3)-sigold) *sig(3)

```

## APPENDIX A

---

```

        sigold=sig(3)
        epsold=eps(3)
        eps(3)=eps(3)+deps
c
        endif
c
c      compute last row of deformation gradient
c
        call compute_f3s(hsv(3),hsv(6),hsv(9),eps(3))
c
c      compute jacobian
c
        detf=hsv(1)*(hsv(5)*hsv(9)-hsv(6)*hsv(8))
1      -hsv(2)*(hsv(4)*hsv(9)-hsv(6)*hsv(7))
2      +hsv(3)*(hsv(4)*hsv(8)-hsv(5)*hsv(7))
c
c      compute normal component of left cauchy-green tensor
c
        b3=hsv(3)*hsv(3)+hsv(6)*hsv(6)+hsv(9)*hsv(9)
c
c      compute normal stress
c
        detfinv=1./detf
        dmu=xmu-xlambda*log(detf)
        sig(1)=detfinv*(xmu*b1-dmu)
        sig(2)=detfinv*(xmu*b2-dmu)
        sig(3)=detfinv*(xmu*b3-dmu)
        sig(4)=detfinv*xmu*b4
c
c      exit loop if normal stress is sufficiently small
c
        if (abs(sig(3)).le.1.e-4*
1      (abs(sig(1))+abs(sig(2))+abs(sig(4)))) goto 10
c
        enddo
c
c      compute remaining components of left cauchy-green tensor
c
10      b5=hsv(2)*hsv(3)+hsv(5)*hsv(6)+hsv(8)*hsv(9)
        b6=hsv(1)*hsv(3)+hsv(4)*hsv(6)+hsv(7)*hsv(9)
c
c      compute remaining stress components
c
        sig(5)=detfinv*xmu*b5
        sig(6)=detfinv*xmu*b6
c
        else
c
c      material model only available for bricks and shells
c
        write (*,20) etype
        write (13,20) etype
        write (59,20) etype
        call adios(2)
c
        endif
c
```

```

20  format(/
1    '***  error element type ',a,' can not be'
2    'run with the current material model. ***')
c
    return
    end

```

## Implicit analysis

For brick and shell elements, a user-defined material model can also be run with implicit analysis. When an implicit analysis is requested in the input keyword deck, LS-DYNA calls the subroutine `urtanh` for bricks and `urtans` for shells with appropriate input data for the calculation of the material tangent modulus. For a scalar implementation, this routine in turn calls `utanXX` with all necessary input parameters including

```
es(6,6) - material tangent modulus
```

Again, `XX` is the number that matches `MT` on the material card. For a vectorized implementation, the routine `utanXXv` is called, this time with the corresponding vector block

```
dsave(nlq,6,6) - material tangent modulus
```

This subroutine builds the tangent modulus to be used for assembling the tangent stiffness matrix and must be provided by the user. This matrix is equal to the zero matrix when entering the user-defined routine, it must be symmetric and if the local coordinate system option is invoked for bricks, then it should be expressed in this local system. For shell elements, it should be expressed in the co-rotational system defined for the current shell element. All transformations back to the global system are made after exiting the user-defined routine.

If the material is hyper-elastic, there are push forward operations of tangent modulus tensor available in

```

subroutine push_forward_4(dsave,
.      f11, f21, f31, f12, f22, f32, f13, f23, f33, lft, llt)

```

which performs a push forward operation on the tangent modulus tensor, and the corresponding scalar routine

```

subroutine push_forward_4s(es,
.      f11, f21, f31, f12, f22, f32, f13, f23, f33)

```

In the latter subroutine all arguments are scalars whereas the corresponding entries in the vectorized routine are vectors of length `nlq`. The `f11` to `f33` are components of the deformation gradient.

The following sample user subroutine illustrates how to implement the tangent stiffness modulus for the Neo-Hookean material above. The material tangent modulus is for this material given by

# APPENDIX A

---

$$\mathbf{C} = \frac{1}{\det \mathbf{F}} (\lambda \mathbf{I} \otimes \mathbf{I} + 2(\mu - \lambda \ln(\det \mathbf{F})) \mathbf{I}).$$

## Sample user subroutine 42, tangent modulus

```
      subroutine utan42 (cm, eps, sig, epsp, hsv, dt1, capa,
.      etype, tt, temper, es, crv)
c*****
c|  livermore software technology corporation  (lstc)
c|  |
c|  -----
c|  |
c|  copyright 1987-1999
c|  |
c|  all rights reserved
c|  |
c*****
c
c      Neo-Hookean material tangent modulus (sample user
subroutine)
c
c      Variables
c
c      cm(1)=first material constant, here young's modulus
c      cm(2)=second material constant, here poisson's ratio
c      .
c      .
c      .
c      cm(n)=nth material constant
c
c      eps(1)=local x  strain increment
c      eps(2)=local y  strain increment
c      eps(3)=local z  strain increment
c      eps(4)=local xy strain increment
c      eps(5)=local yz strain increment
c      eps(6)=local zx strain increment
c
c      sig(1)=local x  stress
c      sig(2)=local y  stress
c      sig(3)=local z  stress
c      sig(4)=local xy stress
c      sig(5)=local yz stress
c      sig(6)=local zx stress
```

```
c
c   epsp=effective plastic strain
c
c   hsv(1)=1st history variable
c   hsv(2)=2nd history variable
c   .
c   .
c   .
c   .
c   hsv(n)=nth history variable
c
c   dtl=current time step size
c   capa=reduction factor for transverse shear
c   etype:
c       eq."brick" for solid elements
c       eq."shell" for all shell elements
c       eq."beam"  for all beam elements
c       eq."dbeam" for all discrete beam elements
c
c   tt=current problem time.
c
c   temper=current temperature
c
c   es=material tangent modulus
c
c   crv=array representation of curves in keyword deck
c
c   The material tangent modulus is set to 0 prior to entering
c   this routine. It should be expressed in the local system
c   upon exiting this routine. All transformations back to the
c   global system is made outside this routine.
c
c   character*(*) etype
c   dimension cm(*),eps(*),sig(*),hsv(*),crv(101,2,*)
c   dimension es(6,*)
c
c   no history variables, NHV=0
c   deformation gradient stored in hsv(1),...,hsv(9)
c
c   compute jacobian
c
c   detf=hsv(1)*(hsv(5)*hsv(9)-hsv(6)*hsv(8))
1       -hsv(2)*(hsv(4)*hsv(9)-hsv(6)*hsv(7))
2       +hsv(3)*(hsv(4)*hsv(8)-hsv(5)*hsv(7))
c
c   compute lame parameters
c
```

## APPENDIX A

---

```
      xlambda=cm(1)*cm(2)/((1.+cm(2))*(1.-2.*cm(2)))
      xmu=.5*cm(1)/(1.+cm(2))
c
c      compute tangent stiffness
c      same for both shells and bricks
c
      detfinv=1./detf
      dmu=xmu-xlambda*log(detf)
      es(1,1)=detfinv*(xlambda+2.*dmu)
      es(2,2)=detfinv*(xlambda+2.*dmu)
      es(3,3)=detfinv*(xlambda+2.*dmu)
      es(4,4)=detfinv*dmu
      es(5,5)=detfinv*dmu
      es(6,6)=detfinv*dmu
      es(2,1)=detfinv*xlambda
      es(3,2)=detfinv*xlambda
      es(3,1)=detfinv*xlambda
      es(1,2)=es(2,1)
      es(2,3)=es(3,2)
      es(1,3)=es(3,1)
c
      return
      end
```

### User-Defined Materials with Equations of State

The following example `umat44v` is set up to be used with an equation of state (EOS). Unlike standard models, it updates only the deviatoric stress and it assigns a value to `PC`, the pressure cut-off. The pressure cut-off limits the amount of hydrostatic pressure that can be carried in tension (i.e., when the pressure is negative). The default value is zero, and a large negative number will allow the material to carry an unlimited pressure load in tension. It is calculated within the material model because it is typically a function of the current state of the material and varies with time. In this example, however, it is a constant value for simplicity. The pressure cut-off array is passed through the named common block `eosdloc`. Depending on the computing environment, compiler directives may be required (e.g., the task common directive in the example) for correct SMP execution.

In addition, the number of history variables, `NHV`, must be increased by 4 in the input file to allocate the extra storage required for the EOS. The storage is the last 4 variables in `hsvs`, and it must not be altered by the user-defined material model.

```
      subroutine umat44v(cm,d1,d2,d3,d4,d5,d6,sig1,sig2,
      . sig3,sig4,sig5,sig6,eps,hsvs,lft,llt,dtlsiz,capa,
      . etype,tt,temps,failels,nlqa,crv)
      parameter (third=1.0/3.0)
      include 'nlqparm'
c
c*** isotropic plasticity with linear hardening
c
```



## APPENDIX A

```
c*** updates only the deviatoric stress so that it can be used with
c     an equation of state
c
c     character*5 etype
c     logical failcls
c
C_TASKCOMMON (eosdloc)
c     common/eosdloc/pc(nlq)
c
c     dimension cm(*),d1(*),d2(*),d3(*),d4(*),d5(*),d6(*),
c     & sig1(*),sig2(*),sig3(*),sig4(*),sig5(*),sig6(*),
c     & eps(*),hsvs(nlqa,*),dtlsiz(*),temps(*),crv(lq1,2,*),
c     & failcls(*)
c
c*** shear modulus, initial yield stress, hardening, and pressure cut-off
g     =cm(1)
sy0  =cm(2)
h     =cm(3)
pcut=cm(4)
c
c     ofac=1.0/(3.0*g+h)
c     twog=2.0*g
c
c     do i=lft,llt
c
c***   trial elastic deviatoric stress
davg=third*(d1(i)+d2(i)+d3(i))
savg=third*(sig1(i)+sig2(i)+sig3(i))
sig1(i)=sig1(i)-savg+twog*(d1(i)-davg)
sig2(i)=sig2(i)-savg+twog*(d2(i)-davg)
sig3(i)=sig3(i)-savg+twog*(d3(i)-davg)
sig4(i)=sig4(i)+g*d4(i)
sig5(i)=sig5(i)+g*d5(i)
sig6(i)=sig6(i)+g*d6(i)
c
c***   radial return
aj2=sqrt(1.5*(sig1(i)**2+sig2(i)**2+sig3(i)**2)+
&      3.0*(sig4(i)**2+sig5(i)**2+sig6(i)**2))
sy=sy0+h*eps(i)
eps(i)=eps(i)+ofac*max(0.0,aj2-sy)
synew=sy0+h*eps(i)
scale=synew/max(synew,aj2)
c
c***   scaling for radial return. note that the stress is now deviatoric.
sig1(i)=scale*sig1(i)
sig2(i)=scale*sig2(i)
sig3(i)=scale*sig3(i)
sig4(i)=scale*sig4(i)
sig5(i)=scale*sig5(i)
sig6(i)=scale*sig6(i)
c
c***   set pressure cut-off
pc(i)=pcut
c
c     enddo
c
c     return
```

# APPENDIX A

---

end

## Post-processing a user-defined material

Post-processing a user-defined material is very similar to post-processing a regular LS-DYNA material. There are however some things that are worth being stressed, all dealing with how to post-process history variables.

First, the effective plastic strain is always written to the d3plot database and thus need not be requested by the user. It is in LS-PRE/POST treated just as it is for any other LS-DYNA material.

The number of additional history variables written to the d3plot database must be requested as the parameter `NEIPH` (for bricks) or `NEIPS` (for shells) on `*DATABASE_EXTENT_BINARY`. For instance, if `NEIPH` (`NEIPS`) equals 2 the first two history variables in the history variables array are obtained as history var#1 and history var#2 in the d3plot database. By putting `NEIPH` (`NEIPS`) equal to `NHV`, all history variables are written to the d3plot database. Furthermore, if the material uses the deformation gradient (`IHYPER=1`) an additional 9 variables must be requested to make this available for post-processing, i.e., put `NEIPH` (`NEIPS`) equal to `NHV+9`. This makes the deformation gradient available in the d3plot database as history variables `NHV+1` to `NHV+9`, note however that for shells it is expressed in the co-rotational system. If the local coordinate system option (`IORTHO=1`) is used, then the deformation gradient is expressed in this local system. To make the deformation gradient in the global system for bricks and co-rotational system for shells available and stored as history variables `NHV+10` to `NHV+18`, `NEIPH` (`NEIPS`) is put equal to `NHV+9+9 (=NHV+18)`.

## APPENDIX B: User Defined Equation of State

The user can supply his/her own subroutines defining equation of state (EOS) models in LS-DYNA. To invoke a user-defined EOS, one must

1. Write a user EOS subroutine that is called by the LS-DYNA user EOS interface.
2. Create a custom executable which includes the EOS subroutine.
3. Invoke that subroutine by defining a part in the keyword input deck that uses `*EOS_USER_DEFINED` with the appropriate input parameters.

All subroutines, including the interface, for the user-defined materials are collected in the file `dyn21.F` (Unix/Linux) or `lsdyna.f` (Windows). Up to ten user subroutines can currently be implemented simultaneously to update the pressure in solids and shells. This text serves as an introductory guide to implementing such a model. Note that names of variables and subroutines below may differ from the actual ones depending on platform and current version of LS-DYNA.

### General overview

When the keyword `*EOS_USER_DEFINED` is defined for a part in the keyword deck, LS-DYNA calls the subroutine `ueoslib` with the appropriate input data for the EOS update. This subroutine is called twice for each integration point in each element. The first call requires the EOS to calculate the bulk modulus, and the second updates the pressure and internal energy. In these routines, which may be modified by the user if necessary, the following data structures are initialized for the purpose of being supplied to a specific scalar material subroutine.

`iflag` - =0 for calculating the bulk modulus, =1 for the pressure and energy update  
`cb` - bulk modulus  
`pnew` - the new pressure  
`rho0` - reference density  
`hist` - array of user-defined history variables `NHV` in length  
`specen` - internal energy per unit reference volume  
`df` - volume ratio,  $V/V_0$   
`v0` - the initial volume.  
`dvol` - volume increment  
`pc` - pressure cut-off

If the vectorization flag is active (`IVECT=1`) on the EOS card, variables are, in general, stored in vector blocks of length `nlq`, with vector indices ranging from `lft` to `llt`, which allows for a more efficient execution of the EOS routine. As an example, the data structures mentioned above for the vectorized case are

`cb(nlq)` - bulk modulus  
`Pnew(nlq)` - the new pressure  
`hist(nlq,*)` - array of user-defined history variables with `NHV` columns  
`specen(nlq)` - internal energy per unit reference volume  
`df(nlq)` - volume ratio,  $V/V_0$   
`v0(nlq)` - the initial volume

## APPENDIX B

---

dv<sub>ol</sub>(nlq) - volume increment  
pc(nlq) - pressure cut-off

The value of nlq is set as a parameter in the include file nlqp<sub>arm</sub>, included at the top of the subroutine, and varies between machines and operating systems. Each entry in a vector block is associated with an integration point in the finite element mesh. The number of entries in the history variables array (indicated by \* in the above) matches the number of history variables requested on the material card (NHV). All history variables are initially zero and are initialized within the EOS on the first time step, when the logical variable first, passed through the argument list, is .TRUE. Furthermore, all user-defined EOS models require a bulk modulus, cb, for transmitting boundaries, contact interfaces, rigid body constraints, and time step calculations. In addition to the variables mentioned above, the following data can be supplied to the user material routines, regardless of whether vectorization is used or not.

eosp(\*) - array of material constants from the input file  
tt - current time  
crv(101,2,\*) - array representation of curves defined in the keyword deck.

A specific material routine, ueosXXs in the scalar case or ueosXXv in the vector case, is now called with any necessary parameters of the ones above, and possibly others as well. The use of curves is discussed in Appendix A. The letters XX stands for a number between 21 and 30 and matches the number EOST on the EOS card. This subroutine is written by the user, and should calculate the bulk modulus when iflag=0, and update the pressure, internal energy and history variables to the current time when iflag=1. During the input phase, the EOS is called with iflag=-1 to permit the initialization of any desired constants in eosp. Although fewer than 48 constants may be read into eosp during the input, the user may use all 48 within the EOS subroutines.

A sample scalar user subroutine for a Gruneisen EOS is provided below and it is immediately followed by its vector counterpart.

### Sample user subroutine 21

```
      subroutine ueos21s(iflag,cb,pnew,hist,rho0,eosp,specen,
&                      df,dvol,v0,pc,dt,tt,crv,first)
      include 'nlqparm'
c
c***  example scalar user implementation of the Gruneisen EOS
c
c***  variables
c      iflag ----- =0 calculate bulk modulus
c                      =1 update pressure and energy
c      cb ----- bulk modulus
c      pnew ----- new pressure
c      hist ----- history variables
c      rho0 ----- reference density
c      eosp ----- EOS constants
c      specen ---- energy/reference volume
c      df ----- volume ratio, v/v0 = rho0/rho
c      dvol ----- change in volume over time step
c      v0 ----- reference volume
```

## APPENDIX B

```
c      pc ----- pressure cut-off
c      dt ----- time step size
c      tt ----- current time
c      crv ----- curve array
c      first ----- logical .true. for tt, crv, first time step
c                   (for initialization of the history variables)
c
c      logical first
c
c      dimension hist(*), eospl(*), crv(101, 2, *)
c
c      c =eospl(1)
c      s1 =eospl(2)
c      s2 =eospl(3)
c      s3 =eospl(4)
c      g0 =eospl(5)
c      sa =eospl(6)
c      s11=s1-1.
c      s22=2.*s2
c      s33=3.*s3
c      s32=2.*s3
c      sad2=.5*sa
c      g0d2=1.-.5*g0
c      roc2=rho0*c**2
c
c      c*** calculate the bulk modulus for the EOS contribution to the sound speed
c      if (iflag.eq.0) then
c          xmu=1.0/df-1.
c          dfmu=df*xmu
c          facp=.5*(1.+sign(1., xmu))
c          facn=1.-facp
c          xnum=1.+xmu*(+g0d2-sad2*xmu)
c          xdem=1.-xmu*(s11+dfmu*(s2+s3*dfmu))
c          tmp=facp/(xdem*xdem)
c          a=roc2*xmu*(facn+tmp*xnum)
c          b=g0+sa*xmu
c          pnum=roc2*(facn+facp*(xnum+xmu*(g0d2-sa*xmu)))
c          pden=2.*xdem*(-s11 +dfmu*(-s22+dfmu*(s2-s33+s32*dfmu)))
c          cb=pnum*(facn+tmp)-tmp*a*pden+sa*specen+
c      &      b*df**2*max(pc, (a+b*specen))
c
c      c*** update the pressure and internal energy
c      else
c          xmu=1.0/df-1.
c          dfmu=df*xmu
c          facp=.5*(1.+sign(1., xmu))
c          facn=1.-facp
c          xnum=1.+xmu*(+g0d2-sad2*xmu)
c          xdem=1.-xmu*(s11+dfmu*(s2+s3*dfmu))
c          tmp=facp/(xdem*xdem)
c          a=roc2*xmu*(facn+tmp*xnum)
c          b=g0+sa*xmu
c          dvov0=0.5*dvol/v0
c          denom=1.+ b*dvov0
c          pnew=(a+specen*b)/max(1.e-6, denom)
c          pnew=max(pnew, pc)
c          specen=specen-pnew*dvov0
```

## APPENDIX B

---

```
        endif
c
c        return
c        end
c        subroutine ueos21v(lft,llt,iflag,cb,pnew,hist,rho0,eosp,specen,
&                          df,dvol,v0,pc,dt,tt,crv,first)
c        include 'nlqparm'
c
c***  example vectorized user implementation of the Gruneisen EOS
c
c***  variables
c        lft,llt --- tt,crv,first and last indices into arrays
c        iflag ----- =0 calculate bulk modulus
c                   =1 update pressure and energy
c        cb ----- bulk modulus
c        pnew ----- new pressure
c        hist ----- history variables
c        rho0 ----- reference density
c        eosp ----- EOS constants
c        specen ----- energy/reference volume
c        df ----- volume ratio, v/v0 = rho0/rho
c        dvol ----- change in volume over time step
c        v0 ----- reference volume
c        pc ----- pressure cut-off
c        dt ----- time step size
c        tt ----- current time
c        crv ----- curve array
c        first ----- logical .true. for tt,crv,first time step
c                   (for initialization of the history variables)
c
c        logical first
c
c        dimension cb(*),pnew(*),hist(nlq,*),eosp(*),
&                specen(*),df(*),dvol(*),pc(*),v0(*)
c
c        c =eosp(1)
c        s1 =eosp(2)
c        s2 =eosp(3)
c        s3 =eosp(4)
c        g0 =eosp(5)
c        sa =eosp(6)
c        s11=s1-1.
c        s22=2.*s2
c        s33=3.*s3
c        s32=2.*s3
c        sad2=.5*sa
c        g0d2=1.-.5*g0
c        roc2=rho0*c**2
c
c***  calculate the bulk modulus for the EOS contribution to the sound speed
c        if (iflag.eq.0) then
c            do i=lft,llt
c                xmu=1.0/df(i)-1.
c                dfmu=df(i)*xmu
c                facp=.5*(1.+sign(1.,xmu))
c                facn=1.-facp
c                xnum=1.+xmu*(+g0d2-sad2*xmu)
```

```

        xdem=1.-xmu*(s11+dfmu*(s2+s3*dfmu))
        tmp=facp/(xdem*xdem)
        a=roc2*xmu*(facn+tmp*xnum)
        b=g0+sa*xmu
        pnum=roc2*(facn+facp*(xnum+xmu*(g0d2-sa*xmu)))
        pden=2.*xdem*(-s11+dfmu*(-s22+dfmu*(s2-s33+s32*dfmu)))
        cb(i)=pnum*(facn+tmp)-tmp*a*pden+sa*specen(i)+
&          b*df(i)**2*max(pc(i),(a+b*specen(i)))
        enddo
c
c*** update the pressure and internal energy
    else
        do i=1ft,1lt
            xmu=1.0/df(i)-1.
            dfmu=df(i)*xmu
            facp=.5*(1.+sign(1.,xmu))
            facn=1.-facp
            xnum=1.+xmu*(+g0d2-sad2*xmu)
            xdem=1.-xmu*(s11+dfmu*(s2+s3*dfmu))
            tmp=facp/(xdem*xdem)
            a=roc2*xmu*(facn+tmp*xnum)
            b=g0+sa*xmu
            dvov0=0.5*dvol(i)/v0(i)
            denom=1.+b*dvov0
            pnew(i)=(a+specen(i)*b)/max(1.e-6,denom)
            pnew(i)=max(pnew(i),pc(i))
            specen(i)=specen(i)-pnew(i)*dvov0
        enddo
    endif
c
    return
end

```

The Gruneisen EOS implemented in the example subroutines has the same form as \*EOS\_GRUNEISEN, EOS Form 4. Its update of the pressure and the internal energy are typical for an EOS that is linear in the internal energy,

$$P = A(\rho) + B(\rho)E$$

where  $A$  and  $B$  correspond to the variables  $a$  and  $b$  in the example subroutines, and  $E$  is  $specen$ . Integrating the energy equation with the trapezoidal rule gives

$$E^{n+1} = E^n + \frac{1}{2}(\sigma'^n + \sigma'^{n+1})\Delta\varepsilon - \frac{1}{2}(P^n + q^n + P^{n+1} + q^{n+1})\frac{\Delta V}{V_0}$$

where the superscripts refer to the time step,  $\Delta V$  is the change in the volume associated with the Gauss point and  $V_0$  is the reference volume. Collecting all the energy contributions on the right hand side except for the contribution from the new pressure gives a simple linear relationship between the new internal energy and pressure,

$$E^{n+1} = \tilde{E} - \frac{P^{n+1}\Delta V}{2V_0}.$$

## APPENDIX B

---

The value of `specen` passed to `ueosXX` for the pressure and energy update corresponds to  $\tilde{E}$ . Substituting this relation into the EOS and solving for the new pressure gives

$$P^{n+1} = \frac{A(\rho^{n+1}) + B(\rho^{n+1})\tilde{E}}{1 + \frac{B\Delta V}{2V_0}}.$$

The final update of the new energy is calculated using the new pressure. For a more general EOS, the nonlinear equation in the new pressure,

$$P^{n+1} = P(\rho^{n+1}, \tilde{E} - \frac{P^{n+1}\Delta V}{2V_0})$$

is solved iteratively using Newton iteration or successive substitution.

The pressure cut-off,  $p_c$ , is used to limited the amount of pressure that can be generated by tensile loading,  $p_{new} = \max(p_{new}, p_c)$ . Its value is usually specified in the `*MAT` input, e.g., `*MAT_JOHNSON_COOK`. It is not enforced outside of the EOS subroutines, and it is up to the user to determine whether or not to enforce the pressure cut-off in `ueosXX`. If the user does enforce it, the pressure cut-off should be applied before the final update to the internal energy otherwise the energy will be incorrect.

Many of the calculations performed to calculate the bulk modulus are the same as those for updating the pressure and energy. Since the bulk modulus calculation always precedes the pressure update, the values may be saved in a `common` block during the bulk modulus calculation to reduce the cost of the pressure update. The arrays used to store the values in the vectorized subroutines should be dimensioned by `nlq`.

One of the most common errors in implementing an EOS from a paper or book is the use of the wrong internal energy. There are three internal energies in common use: the energy per unit mass,  $e_M$ , the energy per unit current volume,  $e_V$ , and the energy per unit reference volume,  $E$ . LS-DYNA always uses the energy per unit reference volume. Some useful relations for converting between EOS in the literature and the variables in LS-DYNA are

$$e_V = E \frac{V_0}{V} = \text{specen} / df$$
$$e_M = E \frac{V_0}{M} = \text{specen} / \text{rho0}$$
$$\rho = \rho_0 \frac{V_0}{V} = \text{rho0} / df$$



**APPENDIX C: User Defined Element Interface for Solids and Shells**

In this appendix the user-defined element interface for solids and shells is described. The interface can accommodate either an integrated or a resultant element. For the integrated element, the user needs to supply two matrices defining the kinematical properties of the element, and choose between using standard LS-DYNA hourglass stabilization, a user-defined stabilization, or no stabilization when zero energy modes are not present. The number and location of the integration points is arbitrary, i.e., user-defined. For the resultant/discrete element formulations, the force and stiffness assembly must also be implemented. History variables can be associated with the user defined elements. If desired, the element may utilize more than the conventional 3 (for bricks) and 6 (for shells) degrees-of-freedom per node.

**USER DEFINED ELEMENTS**

The user element is implemented according to how standard elements are implemented in LS-DYNA with the exception that two user routines are called for setting up the matrices of interest. In the end, the gradient-displacement matrix  $B_{ijkK}$  is constructed with the property that

$$B_{ijkK} u_{kK} = \frac{\partial v_i}{\partial x_j}$$

where  $u_{kK}$  is the vector of velocity nodal degrees of freedom and the right hand side is the velocity gradient. Moreover, the determinant  $J$  of the jacobian matrix determining the mapping from the isoparametric to physical domain is needed for numerical integration. From these expressions, the strains are determined as the symmetric part of the velocity gradient and the spin as the corresponding antisymmetric part. The stresses are evaluated using the constitutive models in LS-DYNA and the internal forces are obtained from

$$f_{kK} = \int \sigma_{ij} B_{ijkK} dV$$

where  $\sigma_{ij}$  are the stresses. Furthermore, the geometric and material tangent stiffnesses are obtained through

$$K_{ijj}^{mat} = \int C_{klmn} B_{klij} B_{mnjj} dV$$

and

$$K_{iljj}^{geo} = \int \sigma_{mn} B_{kmil} B_{knjj} dV$$

where  $C_{klmn}$  is the tangent modulus for the material. The integrals are evaluated using user-defined quadrature using the determinant  $J$ .

## APPENDIX C

---

For user-defined hourglass control, the user must provide the corresponding internal force and stiffness contribution in a separate user routine. There is also the option to provide the force and stiffness matrix directly for the entire element.

To invoke a user-defined element one must do the following:

1. Write user element subroutine that defines the kinematics or kinetics of the element.
2. Create a custom executable which includes these subroutines.
3. Invoke the element by specifying this on the corresponding \*SECTION card.

The dummy subroutines for the user defined elements are provided to the user in a FORTRAN source file for you to modify along with the necessary object files to compile a new executable. Contact LSTC or your local distributor for information about how to obtain these files as well as what compiler/version to use for your specific platform. Up to five user elements can simultaneously be used for bricks and shells (i.e. a total of ten). This text serves as an introductory guide on how to implement such an element.

### General overview

To activate a user-defined element, it is necessary to set `ELFORM` to a number between 101 and 105 on the \*SECTION definition. By doing so, the kinematics of the elements in the corresponding part will be determined from calling the subroutine

```
subroutine uXXX_bYYY(bmtrx, gmtrx, gjac, ...  
dimension bmtrx(nlq, 3, 3, *), gmtrx(nlq, 3, 3), gjac(*)
```

where `XXX` is substituted for `shl` for a shell-section and `sld` for a solid-section and `YYY` is the number specified in position `ELFORM`. Depending on the choice of `ITAJ` in the input, the user should set the matrices as follows.

If `ITAJ=0`, then set the isoparametric gradient-displacement matrix, represented by the array `bmtrx`, and jacobian matrix, represented by the array `gmtrx`. Here, the first index corresponds to the LS-DYNA block loop index where `nlq` is the block size. For a more convenient notation in the following, we assign a correspondence between the arrays `gmtrx` and `bmtrx` in the subroutines to matrices/tensors as follows

$$gmtrx(*, i, j) \quad - \quad g_{ij}$$

$$bmtrx(*, i, j, k) \quad - \quad b_{ijk}$$

These matrices should be determined so that at the current integration point:

$$g_{ij} = \frac{\partial x_i}{\partial \xi_j}$$

$$b_{ijk} u_k = \frac{\partial v_i}{\partial \xi_j} \Delta t$$

In the above, summation over repeated indices is assumed. We use the following notation

$x_i(\xi_1, \xi_2, \xi_3, t)$  =  $i$ th component of the current position vector  
at isoparametric coordinate  $(\xi_1, \xi_2, \xi_3)$  and time  $t$ .

$v_i(\xi_1, \xi_2, \xi_3, t)$  =  $i$ th component of the velocity vector  
at isoparametric coordinate  $(\xi_1, \xi_2, \xi_3)$  and time  $t$ .

$\Delta t$  = current time step

$u_k$  =  $k$ th component of the generalized local displacements

$\xi_i$  =  $i$ th component of the isoparametric coordinate ranging from  $-1$  to  $1$ ,

For shells, there is an option to get all variables in either the LS-DYNA local coordinate system ( $ILOC=0$ ) or in the global coordinate system ( $ILOC=1$ ). The matrix for the coordinate system transformation is also passed to the user routines where the columns represent the local unit base vectors. The resulting strains must always be in the local coordinate system for the constitutive evaluations. For no extra degrees of freedom (see below), the index  $k$  in the displacement expression is determined from the formula

$$k = n(m - 1) + d$$

where  $n = 3$  if only translational degrees of freedom are present (typical for solids) and  $n = 6$  if rotational degrees of freedom are present (typical for shells),  $m$  is the local node number ( $m = 1, 2, \dots$ ) and  $d$  is the degree of freedom. The translational degrees of freedom correspond to  $d \leq 3$  and the rotational degrees of freedom to  $4 \leq d \leq 6$ .

If  $ITAJ=1$ , the user should set up the physical gradient-displacement matrix, represented by the array `bmtx`, and jacobian determinant, represented by the array `gjac`. Again, we assign a correspondence between the arrays `gjac` and `bmtx` in the subroutines to matrices/tensors as follows

$$\begin{aligned} \text{gjac} (*) & \quad - \quad \mathbf{J} \\ \text{bmtx} (*, i, j, k) & \quad - \quad b_{ijk} \end{aligned}$$

These matrices should be determined so that at the current integration point:

$$\begin{aligned} \mathbf{J} &= \det \frac{\partial x_i}{\partial \xi_j} \\ b_{ijk} u_k &= \frac{\partial v_i}{\partial x_j} \Delta t \end{aligned}$$

## APPENDIX C

---

To be able to set up these matrices, a set of additional auxiliary variables are passed to the user element subroutines. These include the isoparametric coordinate, the element thickness, and the shape function values, and derivatives. Again, for shells these are expressed in either the local or global coordinate system depending on the user's choice. For more information on these variables, the user is referred to the comments in the subroutines.

The integrated elements can use up to a total of 100 integration points (in the plane for shells) at arbitrary locations. These must be specified in terms of isoparametric coordinates and weights following the first of the user-defined cards in the \*SECTION\_... input. The isoparametric coordinates should range from -1 to 1 and the weights should sum up to 4 for shells and 8 for solids.

It may be necessary to incorporate hourglass stabilization to suppress zero energy modes, this is done by putting IHGF.GT.0 in the input. For IHGF.EQ.1, the LS-DYNA hourglass routines are used automatically and for IHGF.EQ.2 or IHGF.EQ.3 the user must provide hourglass force and stiffness in a specific user-defined routine. If IHGF.EQ.3, physical stabilization becomes available since the resultant material tangent moduli are passed to the hourglass routine to provide the current membrane, bending and coupled membrane-bending stiffness of the material. With  $C_{ij}$  denoting the material tangent modulus in matrix form, the resultant tangent moduli are expressed as

$$\begin{aligned}\bar{C}_{ij}^0 &= \int C_{ij} dV && \text{(membrane)} \\ \bar{C}_{ij}^1 &= \int z^1 C_{ij} dV && \text{(membrane-bending)} \\ \bar{C}_{ij}^2 &= \int z^2 C_{ij} dV && \text{(bending)}\end{aligned}$$

where  $z$  is the thickness coordinate for shells. For solids, only the first resultant modulus is passed. In this case the array has 21 entries that correspond to the subdiagonal terms of the 6 by 6 resultant matrix. For the matrix index  $(i, j)$  in the material tangent modulus matrix, where  $i \geq j$ , the index  $I$  of the array passed to the routine is given by

$$I = i(i-1)/2 + j$$

i.e., the subdiagonal terms are stored row-wise in the array. For shells, all three moduli are passed in the local coordinate system where each array has 15 entries corresponding to the subdiagonal terms of the 5 by 5 resultant matrices. The through thickness direction is here eliminated from the plane stress assumption. The formula for the array indices transformation above holds. This subroutine is called

```
subroutine uXXX_eYYY(force, stiff, ndtot, ...
dimension force(nlq, *), stiff(nlq, ndtot, *)
```

where again  $XXX$  and  $YYY$  should be substituted as described for the other subroutines in the above. The variables in the subroutine corresponds to the force and stiffness as

`force(*,i)`      -       $f_i$

`stiff(*,i,j)`    -       $K_{ij}$

where the indices corresponds to node and degree of freedom numbers exactly as for the displacements. For shells the force and stiffness is set up in the local element system (`ILOC=0`) or global system (`ILOC=1`). The variable `ndtot` is the total number of degrees of freedom for the element. Passed to this subroutine are also the property parameters and history variables associated with the element. The values of the property parameters are defined in the input of a user-defined element. No more than 40 property parameters and 100 history variables can be used for each user-defined element. The history variables must be updated in this routine by the user.

## Resultant/discrete elements

By putting `NIP(P)` equal to 0 in the input, a resultant/discrete element is assumed understood. For this option (which is incompatible with `IHGF.GT.0`) the user must provide force and stiffness in the same user-defined routine as for the user-defined hourglass control. This means that no material routine is called to update stresses and history variables, but all that must be accounted for in the user element routine. Nevertheless, the user should define `*MAT_ELASTIC` as the material for the corresponding part with suitable values of the Young's modulus and Poisson's ratio. These material properties are used for time step calculations and for contact stiffnesses. Again, property parameters and history variables are passed to the routine, and for shells also the thicknesses of the elements. For the shell thickness update option (`ISTUPD.GT.0` on `*CONTROL_SHELL`) it is up to the user to update the thicknesses in this routine.

In what follows, a short description of the additional features associated with the user elements is given.

## Nodal fiber vectors

If a user-defined shell element formulation uses the nodal fiber vectors, this must be specified by putting `IUNF=1` on the `*SECTION_SHELL` card. With this option the nodal fiber vectors are processed in the element routines and can be used as input for determining the  $b_{ijk}$ ,  $g_{ij}/J$ ,  $f_i$  and  $K_{ij}$  tensors/matrices in the user routines. If not, it is assumed that the fiber direction is normal to the plane of the shell at all times. These are expressed in either the local or global system depending on the user's choice. See comments in the subroutines for more information.

## Extra degrees of freedom

Exotic element formulations may require extra degrees-of-freedom per node besides the translational (and rotational) degrees-of-freedom. Currently, up to 3 extra degrees of freedom per node can be used for user-defined elements. To use extra degrees of freedom, a scalar node must be defined for each node that makes up the connectivity of the user element. A scalar node is defined using the keyword `*NODE_SCALAR_VALUE`, in which the user also prescribe initial and boundary conditions associated with the extra variables. The connectivity of the user elements must then be specified with the option `*ELEMENT_SOLID_DOF` or `*ELEMENT_SHELL_DOF`, where an extra line is used to connect the scalar nodes to the element. As an example:

# APPENDIX C

---

```

*NODE_SCALAR_VALUE
$   NID           V1           V2           V3           NDF
    11           1.0           1.0           1.0           1
    12           1.0           1.0           1.0           1
    13           1.0           1.0           1.0           1
    14           1.0           1.0           1.0           1
*ELEMENT_SHELL_DOF
$   EID   PID     N1     N2     N3     N4
    1     1     1     2     3     4
$
           NS1   NS2   NS3   NS4
           11   12   13   14

```

defines an element with one extra degree of freedom. The initial value of the corresponding variable is 1.0 and it is unconstrained. Finally, the user sets the parameter NXDOF on the \*SECTION\_... card to 1, 2 or 3 depending on how many extra degrees of freedom that should be used in the user-defined element. An array `xdof` containing the current values of these extra variables are passed to the user routines for setting up the correct kinematical properties, see comments in the routines for more information. The formula for the displacement index changes to

$$k = (n + n_{\text{x dof}})(m - 1) + d$$

where  $n_{\text{x dof}}$  is the number of extra degrees of freedom. The extra degrees of freedom for each node corresponds to  $n + 1 \leq d \leq n + n_{\text{x dof}}$ . For dynamic simulations, the mass corresponding to these extra nodes are defined using \*ELEMENT\_INERTIA or \*ELEMENT\_MASS.

## Related keywords

The following is a list of keywords that apply to the user defined elements

### The \*SECTION\_SHELL card

A third card with accompanying optional cards of the \*SECTION\_SHELL keyword must be added if the user defined element option is invoked

### Card 3 and accompanying cards

Define if and only if ELFORM=101,102,103,104 or 105

Variable	1	2	3	4	5	6	7	8
Type	I	I	I	I	I	I	I	I
Default	0	0	0	0	0	0	0	0

**Define NIPP cards according to the following format.**

Variable            1            2            3            4            5            6            7            8

Type	F	F	F						
------	---	---	---	--	--	--	--	--	--

**Define LMC property parameters using 8 parameters per card.**

Variable            1            2            3            4            5            6            7            8

Type	F	F	F	F	F	F	F	F	F
------	---	---	---	---	---	---	---	---	---

<u>VARIABLE</u>	<u>DESCRIPTION</u>
ELFORM	GT.100.AND.LT.106: User-defined shell
NIPP	Number of in-plane integration points for user-defined shell (0 if resultant element)
NXDOF	Number of extra degrees of freedom per node for user-defined shell
IUNF	Flag for using nodal fiber vectors in user-defined shell EQ.0: Nodal fiber vectors are not used EQ.1: Nodal fiber vectors are used
IHFG	Flag for using hourglass stabilization (NIPP.GT.0) EQ.0: Hourglass stabilization is not used EQ.1: LS-DYNA hourglass stabilization is used EQ.2: User-defined hourglass stabilization is used
ITAJ	Flag for setting up finite element matrices (NIPP.GT.0) EQ.0: Set up matrices wrt isoparametric domain EQ.1: Set up matrices wrt physical domain
LMC	Number of property parameters
NHSV	Number of history variables
ILOC	Local coordinate system option EQ.0: All variables are passed in the local element system EQ.1: All variables are passed in the global system
XI	First isoparametric coordinate
ETA	Second isoparametric coordinate

# APPENDIX C

---

<u>VARIABLE</u>	<u>DESCRIPTION</u>
WGT	Isoparametric weight
PI	Ith property parameter

For more information on the variables the user may consult the previous sections in this appendix.

## The \*SECTION\_SOLID card

A second card with accompanying optional cards of the \*SECTION\_SOLID keyword must be added if the user defined elements option is invoked.

### Card 2

Define if and only if ELFORM=101,102,103,104 or 105

Variable	1	2	3	4	5	6	7	8
Type	I	I	I	I	I	I		
Default	0	0	0	0	0	0		

Define NIP cards according to the following format.

Variable	1	2	3	4	5	6	7	8
Type	F	F	F	F				

Define LMC property parameters using 8 parameters per card.

Variable	1	2	3	4	5	6	7	8
Type	F	F	F	F	F	F	F	F

<u>VARIABLE</u>	<u>DESCRIPTION</u>
ELFORM	GT.100.AND.LT.106: User-defined solid
NIP	Number of integration points for user-defined solid (0 if resultant element)



VARIABLE	DESCRIPTION
NXDOF	Number of extra degrees of freedom per node for user-defined solid
IHFG	Flag for using hourglass stabilization (NIP.GT.0) EQ.0: Hourglass stabilization is not used EQ.1: LS-DYNA hourglass stabilization is used EQ.2: User-defined hourglass stabilization is used
ITAJ	Flag for setting up finite element matrices (NIP.GT.0) EQ.0: Set up matrices wrt isoparametric domain EQ.1: Set up matrices wrt physical domain
LMC	Number of property parameters
NHSV	Number of history variables
XI	First isoparametric coordinate
ETA	Second isoparametric coordinate
ZETA	Third isoparametric coordinate
WGT	Isoparametric weight
PI	Ith property parameter

For more information on the variables the user may consult the previous sections in this appendix.

### Sample User Shell Element 101 (Belytschko-Tsay shell)

The geometry of the Belytschko-Tsay element in local coordinates can be written

$$x_i = (x_{it} + \frac{t}{2} \xi_3 \delta_{i3}) N_1(\xi_1, \xi_2)$$

$$v_i = (v_{it} + \frac{t}{2} \xi_3 e_{ij3} \omega_{jl}) N_1(\xi_1, \xi_2)$$

where

## APPENDIX C

---

- $x_{ii} = i$  : th component of coordinate of node I  
 $v_{ii} = i$  : th component of translational velocity of node I  
 $\omega_{ji} = j$  : th component of rotational velocity of node I  
 $t =$  thickness of element  
 $e_{ijk} =$  permutation tensor  
 $N_I =$  shape function localized at node I  
 $\delta_{i3} =$  Kronecker delta

Taking the derivative of these expressions with respect to the isoparametric coordinate yields

$$\frac{\partial x_i}{\partial \xi_1} = \left( x_{ii} + \frac{t}{2} \xi_3 \delta_{i3} \right) \frac{\partial N_I}{\partial \xi_1}$$

$$\frac{\partial x_i}{\partial \xi_2} = \left( x_{ii} + \frac{t}{2} \xi_3 \delta_{i3} \right) \frac{\partial N_I}{\partial \xi_2}$$

$$\frac{\partial x_i}{\partial \xi_3} = \frac{t}{2} \delta_{i3}$$

and

$$\frac{\partial v_i}{\partial \xi_1} = \left( v_{ii} + \frac{t}{2} \xi_3 e_{ij3} \omega_{ji} \right) \frac{\partial N_I}{\partial \xi_1}$$

$$\frac{\partial v_i}{\partial \xi_2} = \left( v_{ii} + \frac{t}{2} \xi_3 e_{ij3} \omega_{ji} \right) \frac{\partial N_I}{\partial \xi_2}$$

$$\frac{\partial v_i}{\partial \xi_3} = \frac{t}{2} e_{ij3} \omega_{ji} N_I$$

respectively. Using these expressions the element is implemented as a user-defined shell as follows.

```

subroutine ushl_b101 (bmtx, gmtrx, gjac,
1   xi, eta, zeta,
2   n1, n2, n3, n4,
3   dn1dxi, dn2dxi, dn3dxi, dn4dxi,
4   dn1deta, dn2deta, dn3deta, dn4deta,
5   x1, x2, x3, x4, y1, y2, y3, y4, z1, z2, z3, z4,
6   xdof,
7   thick, thck1, thck2, thck3, thck4,
8   fx1, fx2, fx3, fx4,
9   fy1, fy2, fy3, fy4,
.   fz1, fz2, fz3, fz4,
.   gl11, gl21, gl31, gl12, gl22, gl32, gl13, gl23, gl33,
.   lft, llt)
include 'nlqparm'
c
c   Compute b and g matrix for user-defined shell 101
  
```

```

c
dimension bmtrx(nlq,3,3,*),gmtrx(nlq,3,3),gjac(nlq)
REAL n1,n2,n3,n4
dimension x1(nlq),x2(nlq),x3(nlq),x4(nlq)
dimension y1(nlq),y2(nlq),y3(nlq),y4(nlq)
dimension z1(nlq),z2(nlq),z3(nlq),z4(nlq)
dimension thick(nlq)
dimension thck1(nlq),thck2(nlq),thck3(nlq),thck4(nlq)
dimension xdof(nlq,8,3)
dimension fx1(nlq),fx2(nlq),fx3(nlq),fx4(nlq)
dimension fy1(nlq),fy2(nlq),fy3(nlq),fy4(nlq)
dimension fz1(nlq),fz2(nlq),fz3(nlq),fz4(nlq)
dimension gl11(nlq),gl21(nlq),gl31(nlq),
.      gl12(nlq),gl22(nlq),gl32(nlq),
.      gl13(nlq),gl23(nlq),gl33(nlq)
c
do i=lft,llt
c
gmtrx(i,1,1)=
1      x1(i)*dn1dxi+x2(i)*dn2dxi+
2      x3(i)*dn3dxi+x4(i)*dn4dxi
gmtrx(i,2,1)=
1      y1(i)*dn1dxi+y2(i)*dn2dxi+
2      y3(i)*dn3dxi+y4(i)*dn4dxi
gmtrx(i,3,1)=
1      0.
gmtrx(i,1,2)=
1      x1(i)*dn1deta+x2(i)*dn2deta+
2      x3(i)*dn3deta+x4(i)*dn4deta
gmtrx(i,2,2)=
1      y1(i)*dn1deta+y2(i)*dn2deta+
2      y3(i)*dn3deta+y4(i)*dn4deta
gmtrx(i,3,2)=
1      0.
gmtrx(i,1,3)=
1      0.
gmtrx(i,2,3)=
1      0.
gmtrx(i,3,3)=
1      .5*thick(i)
c
coef=.5*thick(i)*zeta
c
bmtrx(i,1,1,1) =dn1dxi
bmtrx(i,1,1,7) =dn2dxi
bmtrx(i,1,1,13)=dn3dxi
bmtrx(i,1,1,19)=dn4dxi
c
bmtrx(i,1,1,5) =coef*dn1dxi
bmtrx(i,1,1,11)=coef*dn2dxi
bmtrx(i,1,1,17)=coef*dn3dxi
bmtrx(i,1,1,23)=coef*dn4dxi
c
bmtrx(i,1,2,1) =dn1deta
bmtrx(i,1,2,7) =dn2deta
bmtrx(i,1,2,13)=dn3deta
bmtrx(i,1,2,19)=dn4deta

```

## APPENDIX C

---

```
c
    bmtrx(i,1,2,5) =coef*dn1deta
    bmtrx(i,1,2,11)=coef*dn2deta
    bmtrx(i,1,2,17)=coef*dn3deta
    bmtrx(i,1,2,23)=coef*dn4deta
c
    bmtrx(i,2,1,2) =dn1dxi
    bmtrx(i,2,1,8) =dn2dxi
    bmtrx(i,2,1,14)=dn3dxi
    bmtrx(i,2,1,20)=dn4dxi
c
    bmtrx(i,2,1,4) =-coef*dn1dxi
    bmtrx(i,2,1,10)=-coef*dn2dxi
    bmtrx(i,2,1,16)=-coef*dn3dxi
    bmtrx(i,2,1,22)=-coef*dn4dxi
c
    bmtrx(i,1,3,5) =.5*thick(i)*n1
    bmtrx(i,1,3,11)=.5*thick(i)*n2
    bmtrx(i,1,3,17)=.5*thick(i)*n3
    bmtrx(i,1,3,23)=.5*thick(i)*n4
c
    bmtrx(i,3,1,3) =dn1dxi
    bmtrx(i,3,1,9) =dn2dxi
    bmtrx(i,3,1,15)=dn3dxi
    bmtrx(i,3,1,21)=dn4dxi
c
    bmtrx(i,2,2,2) =dn1deta
    bmtrx(i,2,2,8) =dn2deta
    bmtrx(i,2,2,14)=dn3deta
    bmtrx(i,2,2,20)=dn4deta
c
    bmtrx(i,2,2,4) =-coef*dn1deta
    bmtrx(i,2,2,10)=-coef*dn2deta
    bmtrx(i,2,2,16)=-coef*dn3deta
    bmtrx(i,2,2,22)=-coef*dn4deta
c
    bmtrx(i,2,3,4) =-.5*thick(i)*n1
    bmtrx(i,2,3,10)=-.5*thick(i)*n2
    bmtrx(i,2,3,16)=-.5*thick(i)*n3
    bmtrx(i,2,3,22)=-.5*thick(i)*n4
c
    bmtrx(i,3,2,3) =dn1deta
    bmtrx(i,3,2,9) =dn2deta
    bmtrx(i,3,2,15)=dn3deta
    bmtrx(i,3,2,21)=dn4deta
c
    enddo
c
    return
end
```

To use the element for a part the section card can be written as

```
*SECTION_SHELL
$   SECID      ELFORM
      1          101
$   T1          T2          T3          T4
```

\$	NIPP	NXDOF	IUNF	IHGF
	1	0	0	1
\$	XI	ETA	WGT	
	0.	0.	4.	

### Sample User Solid Element 101 (constant stress solid)

The geometry for the constant stress solid is given as

$$x_i = x_{ii} N_I(\xi_1, \xi_2)$$

$$v_i = v_{ii} N_I(\xi_1, \xi_2)$$

where

$x_{ii}$  =  $i$ :th component of coordinate of node  $I$

$v_{ii}$  =  $i$ :th component of translational velocity of node  $I$

$N_I$  = shape function localized at node  $I$

The matrices necessary for implementing this element as a user-defined solid are derived from the expressions given by

$$\frac{\partial x_i}{\partial \xi_1} = x_{ii} \frac{\partial N_I}{\partial \xi_1}$$

$$\frac{\partial x_i}{\partial \xi_2} = x_{ii} \frac{\partial N_I}{\partial \xi_2}$$

$$\frac{\partial x_i}{\partial \xi_3} = x_{ii} \frac{\partial N_I}{\partial \xi_3}$$

and

$$\frac{\partial v_i}{\partial \xi_1} = v_{ii} \frac{\partial N_I}{\partial \xi_1}$$

$$\frac{\partial v_i}{\partial \xi_2} = v_{ii} \frac{\partial N_I}{\partial \xi_2}$$

$$\frac{\partial v_i}{\partial \xi_3} = v_{ii} \frac{\partial N_I}{\partial \xi_3}$$

The user element implementation is given by

```

subroutine usld_b101(bmtrx,gmtrx,gjac,
1      xi,eta,zeta,
2      n1,n2,n3,n4,n5,n6,n7,n8,
3      dn1dxi,dn2dxi,dn3dxi,dn4dxi,
4      dn5dxi,dn6dxi,dn7dxi,dn8dxi,
5      dn1deta,dn2deta,dn3deta,dn4deta,
```

## APPENDIX C

---

```
6     dn5deta, dn6deta, dn7deta, dn8deta,
7     dn1dzeta, dn2dzeta, dn3dzeta, dn4dzeta,
8     dn5dzeta, dn6dzeta, dn7dzeta, dn8dzeta,
9     x1, x2, x3, x4, x5, x6, x7, x8,
.     y1, y2, y3, y4, y5, y6, y7, y8,
.     z1, z2, z3, z4, z5, z6, z7, z8,
.     xdof,
.     lft, llt)
include 'nlqparm'

c
c     Compute b and g matrix for user-defined solid 101
c
dimension bmtrx(nlq, 3, 3, *) , gmtrx(nlq, 3, 3) , gjac(nlq)
REAL n1, n2, n3, n4, n5, n6, n7, n8
dimension x1(nlq) , x2(nlq) , x3(nlq) , x4(nlq)
dimension x5(nlq) , x6(nlq) , x7(nlq) , x8(nlq)
dimension y1(nlq) , y2(nlq) , y3(nlq) , y4(nlq)
dimension y5(nlq) , y6(nlq) , y7(nlq) , y8(nlq)
dimension z1(nlq) , z2(nlq) , z3(nlq) , z4(nlq)
dimension z5(nlq) , z6(nlq) , z7(nlq) , z8(nlq)
dimension xdof(nlq, 8, 3)

c
do i=lft, llt
c
gmtrx(i, 1, 1)=x1(i)*dn1dxi+x2(i)*dn2dxi+
1     x3(i)*dn3dxi+x4(i)*dn4dxi+
2     x5(i)*dn5dxi+x6(i)*dn6dxi+
3     x7(i)*dn7dxi+x8(i)*dn8dxi
gmtrx(i, 2, 1)=y1(i)*dn1dxi+y2(i)*dn2dxi+
1     y3(i)*dn3dxi+y4(i)*dn4dxi+
2     y5(i)*dn5dxi+y6(i)*dn6dxi+
3     y7(i)*dn7dxi+y8(i)*dn8dxi
gmtrx(i, 3, 1)=z1(i)*dn1dxi+z2(i)*dn2dxi+
1     z3(i)*dn3dxi+z4(i)*dn4dxi+
2     z5(i)*dn5dxi+z6(i)*dn6dxi+
3     z7(i)*dn7dxi+z8(i)*dn8dxi
gmtrx(i, 1, 2)=x1(i)*dn1deta+x2(i)*dn2deta+
1     x3(i)*dn3deta+x4(i)*dn4deta+
2     x5(i)*dn5deta+x6(i)*dn6deta+
3     x7(i)*dn7deta+x8(i)*dn8deta
gmtrx(i, 2, 2)=y1(i)*dn1deta+y2(i)*dn2deta+
1     y3(i)*dn3deta+y4(i)*dn4deta+
2     y5(i)*dn5deta+y6(i)*dn6deta+
3     y7(i)*dn7deta+y8(i)*dn8deta
gmtrx(i, 3, 2)=z1(i)*dn1deta+z2(i)*dn2deta+
1     z3(i)*dn3deta+z4(i)*dn4deta+
2     z5(i)*dn5deta+z6(i)*dn6deta+
3     z7(i)*dn7deta+z8(i)*dn8deta
gmtrx(i, 1, 3)=x1(i)*dn1dzeta+x2(i)*dn2dzeta+
1     x3(i)*dn3dzeta+x4(i)*dn4dzeta+
2     x5(i)*dn5dzeta+x6(i)*dn6dzeta+
3     x7(i)*dn7dzeta+x8(i)*dn8dzeta
gmtrx(i, 2, 3)=y1(i)*dn1dzeta+y2(i)*dn2dzeta+
1     y3(i)*dn3dzeta+y4(i)*dn4dzeta+
2     y5(i)*dn5dzeta+y6(i)*dn6dzeta+
3     y7(i)*dn7dzeta+y8(i)*dn8dzeta
gmtrx(i, 3, 3)=z1(i)*dn1dzeta+z2(i)*dn2dzeta+
```

```

1      z3(i)*dn3dzeta+z4(i)*dn4dzeta+
2      z5(i)*dn5dzeta+z6(i)*dn6dzeta+
3      z7(i)*dn7dzeta+z8(i)*dn8dzeta

```

c

```

bmtrx(i,1,1,1) =dn1dxi
bmtrx(i,1,1,4) =dn2dxi
bmtrx(i,1,1,7) =dn3dxi
bmtrx(i,1,1,10)=dn4dxi
bmtrx(i,1,1,13)=dn5dxi
bmtrx(i,1,1,16)=dn6dxi
bmtrx(i,1,1,19)=dn7dxi
bmtrx(i,1,1,22)=dn8dxi

```

c

```

bmtrx(i,2,1,2) =dn1dxi
bmtrx(i,2,1,5) =dn2dxi
bmtrx(i,2,1,8) =dn3dxi
bmtrx(i,2,1,11)=dn4dxi
bmtrx(i,2,1,14)=dn5dxi
bmtrx(i,2,1,17)=dn6dxi
bmtrx(i,2,1,20)=dn7dxi
bmtrx(i,2,1,23)=dn8dxi

```

c

```

bmtrx(i,3,1,3) =dn1dxi
bmtrx(i,3,1,6) =dn2dxi
bmtrx(i,3,1,9) =dn3dxi
bmtrx(i,3,1,12)=dn4dxi
bmtrx(i,3,1,15)=dn5dxi
bmtrx(i,3,1,18)=dn6dxi
bmtrx(i,3,1,21)=dn7dxi
bmtrx(i,3,1,24)=dn8dxi

```

c

```

bmtrx(i,1,2,1) =dn1deta
bmtrx(i,1,2,4) =dn2deta
bmtrx(i,1,2,7) =dn3deta
bmtrx(i,1,2,10)=dn4deta
bmtrx(i,1,2,13)=dn5deta
bmtrx(i,1,2,16)=dn6deta
bmtrx(i,1,2,19)=dn7deta
bmtrx(i,1,2,22)=dn8deta

```

c

```

bmtrx(i,2,2,2) =dn1deta
bmtrx(i,2,2,5) =dn2deta
bmtrx(i,2,2,8) =dn3deta
bmtrx(i,2,2,11)=dn4deta
bmtrx(i,2,2,14)=dn5deta
bmtrx(i,2,2,17)=dn6deta
bmtrx(i,2,2,20)=dn7deta
bmtrx(i,2,2,23)=dn8deta

```

c

```

bmtrx(i,3,2,3) =dn1deta
bmtrx(i,3,2,6) =dn2deta
bmtrx(i,3,2,9) =dn3deta
bmtrx(i,3,2,12)=dn4deta
bmtrx(i,3,2,15)=dn5deta
bmtrx(i,3,2,18)=dn6deta
bmtrx(i,3,2,21)=dn7deta
bmtrx(i,3,2,24)=dn8deta

```

# APPENDIX C

---

```
c
    bmtrx(i,1,3,1) =dn1dzeta
    bmtrx(i,1,3,4) =dn2dzeta
    bmtrx(i,1,3,7) =dn3dzeta
    bmtrx(i,1,3,10)=dn4dzeta
    bmtrx(i,1,3,13)=dn5dzeta
    bmtrx(i,1,3,16)=dn6dzeta
    bmtrx(i,1,3,19)=dn7dzeta
    bmtrx(i,1,3,22)=dn8dzeta
```

```
c
    bmtrx(i,2,3,2) =dn1dzeta
    bmtrx(i,2,3,5) =dn2dzeta
    bmtrx(i,2,3,8) =dn3dzeta
    bmtrx(i,2,3,11)=dn4dzeta
    bmtrx(i,2,3,14)=dn5dzeta
    bmtrx(i,2,3,17)=dn6dzeta
    bmtrx(i,2,3,20)=dn7dzeta
    bmtrx(i,2,3,23)=dn8dzeta
```

```
c
    bmtrx(i,3,3,3) =dn1dzeta
    bmtrx(i,3,3,6) =dn2dzeta
    bmtrx(i,3,3,9) =dn3dzeta
    bmtrx(i,3,3,12)=dn4dzeta
    bmtrx(i,3,3,15)=dn5dzeta
    bmtrx(i,3,3,18)=dn6dzeta
    bmtrx(i,3,3,21)=dn7dzeta
    bmtrx(i,3,3,24)=dn8dzeta
```

```
c
    enddo
```

```
c
    return
end
```

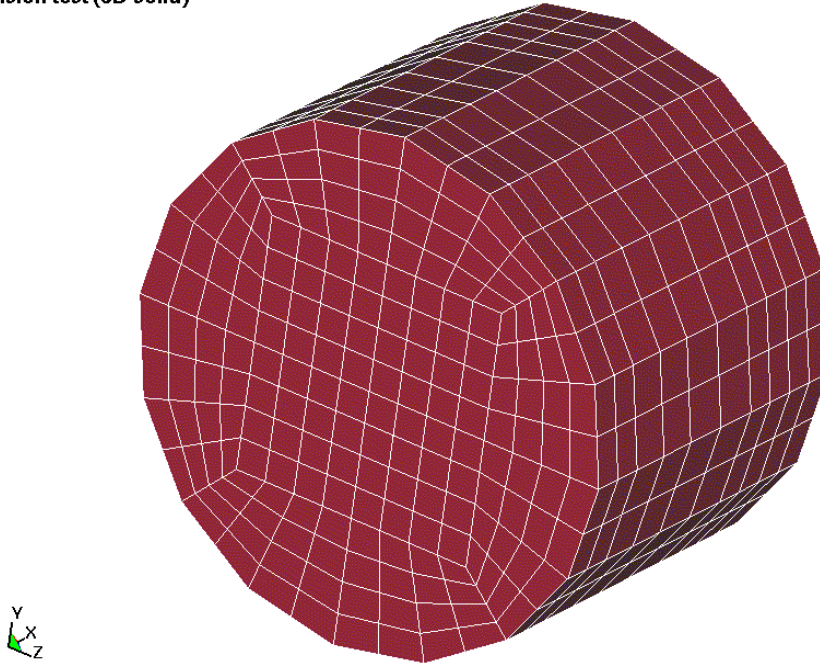
To use the element for a part the section card can be written as

```
*SECTION_SOLID
$   SECID   ELFORM
    1       101
$   NIP     NXDOF   IHGF
    1       0       1
$   XI      ETA     ZETA   WGT
    0.      0.      0.     8.0
```

## Examples



Tension test (3D solid)

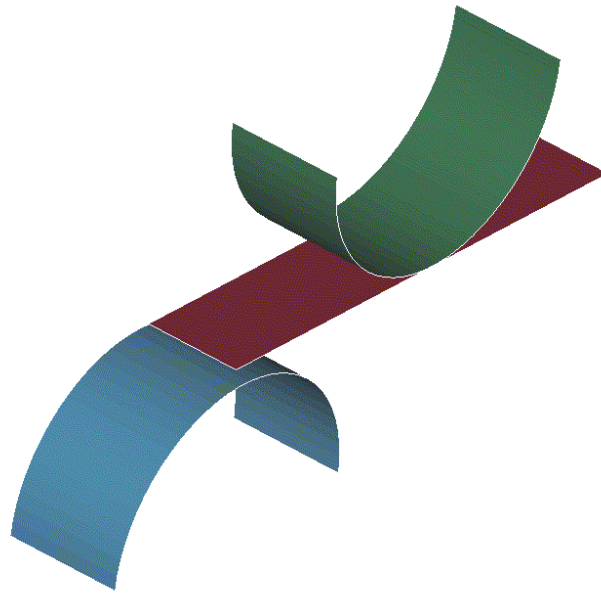


**Figure C.1** Solid mesh for user element test.

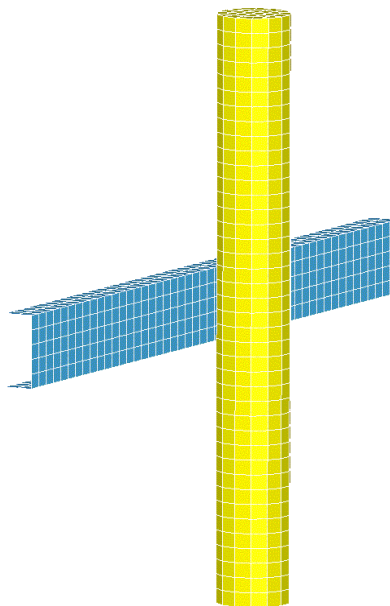
We present three test examples.

One example was a simple tension-compression test of a solid cylinder. The geometry is shown in Figure C.1. The problem is using the sample implementations of user elements and compared the results and performance with standard LS-DYNA elements. As for the computational efficiency, we note that the performance is worse but this is expected since there is little room for optimization of the code while retaining a user friendly interface. The implicit performance compares well with the other elements in LS-DYNA.

The second example was a combined bending and stretching example with the geometry shown in Figure C.2. Again we ran the problem with the user element implementations and compared the results and performance with standard LS-DYNA elements. We could see the same tendencies as for the solid elements.



**Figure C.2** Shell mesh for the user element test.



**Figure C.3** Impact between a user-defined shell and user-defined solid part.

The third and final example is an impact between a solid bar and shell beam. Both parts are modeled with user-defined elements. The results were very similar to the ones obtained by substituting the sections for standard LS-DYNA sections, but the simulation time was about 3-4 times longer.

## APPENDIX D: User Defined Airbag Sensor

The addition of a user sensor subroutine into LS-DYNA is relatively simple. The sensor is mounted on a rigid body which is attached to the structure. The motion of the sensor is provided in the local coordinate system defined for the rigid body in the definition of material model 20—the rigid material. When the user defined criterion is met for the deployment of the airbag, a flag is set and the deployment begins. All load curves relating to the mass flow rate versus time are then shifted by the initiation time. The user subroutine is given below with all the necessary information contained in the comment cards.

```

SUBROUTINE AIRUSR (RBU, RBV, RBA, TIME, DT1, DT2, PARAM, HIST, ITRNON,
. RBUG, RBVG, RBAG)
C*****
C | LIVERMORE SOFTWARE TECHNOLOGY CORPORATION (LSTC) |
C | ----- |
C | COPYRIGHT 1987, 1988, 1989 JOHN O. HALLQUIST, LSTC |
C | ALL RIGHTS RESERVED |
C*****
C
C USER SUBROUTINE TO INITIATE THE INFLATION OF THE AIRBAG
C
C VARIABLES
C
C DISPLACEMENTS ARE DEFINED AT TIME N+1 IN LOCAL SYSTEM
C VELOCITIES ARE DEFINED AT TIME N+1/2 IN LOCAL SYSTEM
C ACCELERATIONS ARE DEFINED AT TIME N IN LOCAL SYSTEM
C
C RBU(1-3) TOTAL DISPLACEMENTS IN THE LOCAL XYZ DIRECTIONS
C RBU(3-6) TOTAL ROTATIONS ABOUT THE LOCAL XYZ AXES
C RBV(1-3) VELOCITIES IN THE LOCAL XYZ DIRECTIONS
C RBV(3-6) ROTATIONAL VELOCITIES ABOUT THE LOCAL XYZ AXES
C RBA(1-3) ACCELERATIONS IN THE LOCAL XYZ DIRECTIONS
C RBA(3-6) ROTATIONAL ACCELERATIONS ABOUT THE LOCAL XYZ AXES
C TIME IS THE CURRENT TIME
C DT1 IS TIME STEP SIZE AT N-1/2
C DT2 IS TIME STEP SIZE AT N+1/2
C PARAM IS USER DEFINED INPUT PARAMETERS (MAX 25)
C HIST IS USER DEFINED HISTORY VARIABLES (MAX 25)
C ITRNON IS FLAG TO TURN ON THE AIRBAG INFLATION
C RBUG, RBVG, RBAG, ARE SIMILAR TO RBU, RBV, RBA BUT ARE DEFINED
C GLOBALLY.
C
C THE USER SUBROUTINE SETS THE VARIABLE ITRNON TO:
C
C ITRNON=0 BAG IS NOT INFLATED
C ITRNON=1 BAG INFLATION BEGINS AND THIS SUBROUTINE IS NOT
C CALLED AGAIN
C
C DIMENSION RBU(6), RBV(6), PARAM(25), HIST(25),
. RBUG(6), RBVG(6), RBAG(6)
RETURN
END

```



## APPENDIX E: User Defined Solution Control

This subroutine may be provided by the user to control the I/O, monitor the energies and other solution norms of interest, and to shut down the problem whenever he pleases. The arguments are defined in the listing provided below. This subroutine is called each time step and does not need any control card to operate.

```

SUBROUTINE UCTRL1 (NUMNP, NDOF, TIME, DT1, DT2, PRTC, PLTC, FRCI, PRTO,
. PLTO, FRCO, VT, VR, AT, AR, UT, UR, XMST, XMSR, IRBODY, RBDYN, USRHV,
. MESSAG, TOTALM, CYCL, IDRINT)
C*****
C | LIVERMORE SOFTWARE TECHNOLOGY CORPORATION (LSTC) |
C | ----- |
C | COPYRIGHT 1987, 1988, 1989 JOHN O. HALLQUIST, LSTC |
C | ALL RIGHTS RESERVED |
C*****
C
C CHARACTER*(*) MESSAG
C INTEGER CYCLE
C
C
C USER SUBROUTINE FOR SOLUTION CONTROL
C
C NOTE: LS-DYNA USED AN INTERNAL NUMBERING SYSTEM TO
C ACCOMMODATE ARBITRARY NODE NUMBERING. TO ACCESS
C INFORMATION FOR USER NODE N, ADDRESS ARRAY LOCATION M,
C M=LQF(N,1). TO OBTAIN USER NODE NUMBER, N,
C CORRESPONDING TO ARRAY ADDRESS M, SET N=LQFINV(M,1)
C
C ARGUMENTS:
C NUMNP=NUMBER OF NODAL POINTS
C NDOF=NUMBER OF DEGREES OF FREEDOM PER NODE
C TIME=CURRENT SOLUTION TIME
C PRTC=OUTPUT INTERVAL FOR LS-DYNA TIME HISTORY DATA
C PLTC=OUTPUT INTERVAL FOR LS-DYNA STATE DATA
C FRCI=OUTPUT INTERVAL FOR LS-DYNA INTERFACE FORCE DATA
C PRTO=OUTPUT TIME FOR TIME HISTORY FILE
C PLTO=OUTPUT TIME FOR STATE DATA
C FRCO=OUTPUT TIME FOR FORCE DATA
C VT(3,NUMNP) =NODAL TRANSLATIONAL VELOCITY VECTOR
C VR(3,NUMNP) =NODAL ROTATIONAL VELOCITY VECTOR. THIS ARRAY
C IS DEFINED IF AND ONLY IF NDOF=6
C AT(3,NUMNP) =NODAL TRANSLATIONAL ACCELERATION VECTOR
C AR(3,NUMNP) =NODAL ROTATIONAL ACCELERATION VECTOR. THIS
C ARRAY IS DEFINED IF AND ONLY IF NDOF=6
C UT(3,NUMNP) =NODAL TRANSLATIONAL DISPLACEMENT VECTOR
C UR(3,NUMNP) =NODAL ROTATIONAL DISPLACEMENT VECTOR. THIS ARRAY
C IS DEFINED IF AND ONLY IF NDOF=6
C XMST(NUMNP) =RECIPROCAL OF NODAL TRANSLATIONAL MASSES
C XMSR(NUMNP) =RECIPROCAL OF NODAL ROTATIONAL MASSES. THIS
C ARRAY IS DEFINED IF AND ONLY IF NDOF=6
C IRBODY =FLAG FOR RIGID BODY NODAL POINTS
C IF DEFORMABLE NODE THEN SET TO 1.0
C IF RIGID BODY NODE THEN SET TO 0.0
C DEFINED IF AND ONLY IF RIGID BODY ARE PRESENT

```

# APPENDIX E

---

```
C          I.E.,IRBODY.NE.0 IF NO RIGID BODY ARE PRESENT
C      USRHV (LENHV) =USER DEFINED HISTORY VARIABLES THAT ARE STORED
C          IN THE RESTART FILE.  LENHV=100+U*NUMMAT WHERE
C          NUMMAT IS THE # OF MATERIALS IN THE PROBLEM.
C          ARRAY USRHV IS UPDATED ONLY IN THIS SUBROUTINE.
C      MESSAG      =FLAG FOR DYNA3D WHICH MAY BE SET TO:
C          'SW1.' LS-DYNA TERMINATES WITH RESTART FILE
C          'SW3.' LS-DYNA WRITES A RESTART FILE
C          'SW4.' LS-DYNA WRITES A PLOT STATE
C      TOTALM      =TOTAL MASS IN PROBLEM
C          CYCLE =CYCLE NUMBER
C          IDRINT  =FLAG FOR DYNAMIC RELAXATION PHASE
C          .NE.0:  DYNAMIC RELAXATION IN PROGRESS
C          .EQ.0:  SOLUTION PHASE
C
C      COMMON/PTIMES/  PRTIMS (32) , PRTLST (32) , IGMPT
C
C      PRTIMS (32)=OUTPUT INTERVALS FOR ASCII FILES
C
C      ASCII FILES
C          ( 1)=CROSS SECTION FORCES
C          ( 2)=RIGID WALL FORCES
C          ( 3)=NODAL DATA
C          ( 4)=ELEMENT DATA
C          ( 5)=GLOBAL DATA
C          ( 6)=DISCRETE ELEMENTS
C          ( 7)=MATERIAL ENERGIES
C          ( 8)=NODAL INTERFACE FORCES
C          ( 9)=RESULTANT INTERFACE FORCES
C          (10)=SMUG ANIMATOR
C          (11)=SPC REACTION FORCES
C          (12)=NODAL CONSTRAIN RESULTANT FORCES
C          (13)=AIRBAG STATISTICS
C          (14)=AVS DATABASE
C          (15)=NODAL FORCE GROUPS
C          (16)=OUTPUT INTERVALS FOR NODAL BOUNDARY CONDITIONS
C          (17)-(32)=UNUSED AT THIS TIME
C
C      PRTLST (32)=OUTPUT TIMES FOR ASCII FILES ABOVE.  WHEN SOLUTION TIME
C          EXCEEDS THE OUTPUT TIME A PRINT STATE IS DUMPED.
C
C      COMMON/RBKENG/ENRBDY, RBDYX, RBDYY, RBDYZ
C
C      TOTAL RIGID BODY ENERGIES AND MOMENTUMS:
C          ENRBDY=RIGID BODY KINETIC ENERGY
C          RBDYX =RIGID BODY X-MOMENTUM
C          RBDYY =RIGID BODY Y-MOMENTUM
C          RBDYZ =RIGID BODY Z-MOMENTUM
C
C      COMMON/RBKENG/ENRBDY, RBDYX, RBDYY, RBDYZ
C
C      TOTAL RIGID BODY ENERGIES AND MOMENTUMS:
C          SWXMOM=STONEWALL X-MOMENTUM
C          SWYMOM=STONEWALL Y-MOMENTUM
C          SWZMOM=STONEWALL Z-MOMENTUM
C          ENRBDY=STONEWALL KINETIC ENERGY
C
```

# APPENDIX E

```
COMMON/DEENG/DEENG
C
C DEENG=TOTAL DISCRETE ELEMENT ENERGY
C
COMMON/ENERGY/XPE
C
C XPE =TOTAL INTERNAL ENERGY IN THE FINITE ELEMENTS
C
DIMENSION VT(3,*),VR(3,*),AT(3,*),AR(3,*),UT(3,*),UR(3,*),
XMST(*),XMSR(*),RBDYN(*),USRHV(*)
C
C SAMPLE MOMENTUM AND KINETIC ENERGY CALCULATIONS
C
C REMOVE ALL COMMENTS IN COLUMN 1 BELOW TO ACTIVATE
CC
CC INITIALIZE KINETIC ENERGY, XKE, AND X,Y,Z MOMENTUMS.
CC
C XKE=2.*SWKENG+2.*ENRBDY
C XM=SWXMOM+RBDYX
C YM=SWYMOM+RBDYY
C ZM=SWZMOM+RBDYZ
CC
C NUMNP2=NUMNP
C IF (NDOF.EQ.6) THEN
C NUMNP2=NUMNP+NUMNP
C ENDIF
C PRINT *,NDOF
C IF (IRBODY.EQ.0) THEN
CC
CC NO RIGID BODIES PRESENT
CC
CC NOTE IN BLANK COMMENT VR FOLLOWS VT. THIS FACT IS USED BELOW.
C DO 10 N=1,NUMNP2
C XMSN=1./XMST(N)
C VN1=VT(1,N)
C VN2=VT(2,N)
C VN3=VT(3,N)
C XM=XM+XMSN*VN1
C YM=YM+XMSN*VN2
C ZM=ZM+XMSN*VN3
C XKE=XKE+XMSN*(VN1*VN1+VN2*VN2+VN3*VN3)
C 10 CONTINUE
CC
C ELSE
CC
CC RIGID BODIES PRESENT
CC
C DO 20 N=1,NUMNP
C XMSN=1./XMST(N)
C VN1=RBDYN(N)*VT(1,N)
C VN2=RBDYN(N)*VT(2,N)
C VN3=RBDYN(N)*VT(3,N)
C XM=XM+XMSN*VN1
C YM=YM+XMSN*VN2
C ZM=ZM+XMSN*VN3
```

## APPENDIX E

---

```
C      XKE=XKE+XMSN* (VN1*VN1+VN2*VN2+VN3*VN3)
C  20 CONTINUE
C      IF (NDOF.EQ.6) THEN
C      DO 30 N=1,NUMNP
C      XMSN=1./XMSR(N)
C      VN1=RBDYN(N)*VR(1,N)
C      VN2=RBDYN(N)*VR(2,N)
C      VN3=RBDYN(N)*VR(3,N)
C      XM=XM+XMSN*VN1
C      YM=YM+XMSN*VN2
C      ZM=ZM+XMSN*VN3
C      XKE=XKE+XMSN* (VN1*VN1+VN2*VN2+VN3*VN3)
C  30 CONTINUE
C      ENDIF
CC
C      ENDIF
      RETURN
      END

CC
CC.....TOTAL KINETIC ENERGY
C      XKE=.5*XKE
CC.....TOTAL INTERNAL ENERGY
C      XIE=.XPE+DEENG
CC.....TOTAL ENERGY
C      XTE=XKE+XPE+DEENG
CC.....TOTAL X-RIGID BODY VELOCITY
C      XRBV=XM/TOTALM
CC.....TOTAL Y-RIGID BODY VELOCITY
C      YRBV=YM/TOTALM
CC.....TOTAL Z-RIGID BODY VELOCITY
C      ZRBV=ZM/TOTALM
C
      RETURN
      END
```



**APPENDIX F: User Defined Interface Control**

This subroutine may be provided by the user to turn the interfaces on and off. This option is activated by the \*USER\_INTERFACE\_CONTROL keyword. The arguments are defined in the listing provided below.

```

SUBROUTINE UCTRL2 (NSI,NTY,TIME,CYCLE,MSR,NMN,NSV,NSN,
1 THMR,THSV,VT,XI,UT,ISKIP,IDRINT,NUMNP,DT2,NINPUT,UA)
C*****
C LIVERMORE SOFTWARE TECHNOLOGY CORPORATION (LSTC)
C -----
C COPYRIGHT 1987, 1988, 1989 JOHN O. HALLQUIST, LSTC
C ALL RIGHTS RESERVED
C*****
C
C INTEGER CYCLE
C
C
C USER SUBROUTINE FOR INTERFACE CONTROL
C
C NOTE: LS-DYNA USED AN INTERNAL NUMBERING SYSTEM TO
C ACCOMMODATE ARBITRARY NODE NUMBERING. TO ACCESS
C INFORMATION FOR USER NODE N, ADDRESS ARRAY LOCATION M,
C M=LQF(N,1). TO OBTAIN USER NODE NUMBER, N,
C CORRESPONDING TO ARRAY ADDRESS M, SET N=LQFINV(M,1)
C
C ARGUMENTS:
C NSI =NUMBER OF SLIDING INTERFACE
C NTY =INTERFACE TYPE.
C .EQ.4:SINGLE SURFACE
C .NE.4:SURFACE TO SURFACE
C TIME =CURRENT SOLUTION TIME
C CYCLE =CYCLE NUMBER
C MSR(NMN) =LIST OF MASTER NODES NUMBERS IN INTERNAL
C NUMBERING SCHEME
C NMN =NUMBER OF MASTER NODES
C NSV(NSN) =LIST OF SLAVE NODES NUMBERS IN INTERNAL
C NUMBERING SCHEME
C NSN =NUMBER OF SLAVE NODES
C THMR(NMN) =MASTER NODE THICKNESS
C THSV(NSN) =SLAVE NODE THICKNESS
C VT(3,NUMNP) =NODAL TRANSLATIONAL VELOCITY VECTOR
C XI(3,NUMNP) =INITIAL COORDINATES AT TIME=0
C UT(3,NUMNP) =NODAL TRANSLATIONAL DISPLACEMENT VECTOR
C IDRINT =FLAG FOR DYNAMIC RELAXATION PHASE
C .NE.0:DYNAMIC RELAXATION IN PROGRESS
C .EQ.0:SOLUTION PHASE
C NUMNP =NUMBER OF NODAL POINTS
C DT2 =TIME STEP SIZE AT N+1/2
C NINPUT =NUMBER OF VARIABLES INPUT INTO UA
C UA(*) =USER'S ARRAY, FIRST NINPUT LOCATIONS
C DEFINED BY USER. THE LENGTH OF THIS
C ARRAY IS DEFINED ON CONTROL CARD 10.
C THIS ARRAY IS UNIQUE TO INTERFACE NSI.

```

# APPENDIX F

---

```
C
C   SET FLAG FOR ACTIVE CONTACT
C     ISKIP=0 ACTIVE
C     ISKIP=1 INACTIVE
C
C*****
C     DIMENSION MSR(*),NSV(*),THMR(*),THSV(*),VT(3,*),XI(3,*),
C           UT(3,*)UA(*)
C
C   THE FOLLOWING SAMPLE OF CODEING IS PROVIDED TO ILLUSTRATE HOW
C   THIS SUBROUTINE MIGHT BE USED.  HERE WE CHECK TO SEE IF THE
C   SURFACES IN THE SURFACE TO SURFACE CONTACT ARE SEPARATED.  IF
C   SO THE ISKIP=1 AND THE CONTACT TREATMENT IS SKIPPED.
C
C   IF (NTY.EQ.4) RETURN
C   DT2HLF=DT2/2.
C   XMIN= 1.E20
C   XMAX=-XMIN
C   YMIN= 1.E20
C   YMAX=-YMIN
C   ZMIN= 1.E20
C   ZMAX=-ZMIN
C   XMINM= 1.E20
C   XMAXM=-XMINM
C   YMINM= 1.E20
C   YMAXM=-YMINM
C   ZMINM= 1.E20
C   ZMAXM=-ZMINM
C   THKS=0.0
C   THKM=0.0
C   DO 10 I=1,NSN
C     DSP1=UT(1,NSV(I))+DT2HLF*VT(1,NSV(I))
C     DSP2=UT(2,NSV(I))+DT2HLF*VT(2,NSV(I))
C     DSP3=UT(3,NSV(I))+DT2HLF*VT(3,NSV(I))
C     X1=XI(1,NSV(I))+DSP1
C     X2=XI(2,NSV(I))+DSP2
C     X3=XI(3,NSV(I))+DSP3
C     THKS =MAX(THSV(I),THKS)
C     XMIN=MIN(XMIN,X1)
C     XMAX=MAX(XMAX,X1)
C     YMIN=MIN(YMIN,X2)
C     YMAX=MAX(YMAX,X2)
C     ZMIN=MIN(ZMIN,X3)
C     ZMAX=MAX(ZMAX,X3)
10 CONTINUE
C   DO 20 I=1,NMN
C     DSP1=UT(1,MSR(I))+DT2HLF*VT(1,MSR(I))
C     DSP2=UT(2,MSR(I))+DT2HLF*VT(2,MSR(I))
C     DSP3=UT(3,MSR(I))+DT2HLF*VT(3,MSR(I))
C     X1=XI(1,MSR(I))+DSP1
C     X2=XI(2,MSR(I))+DSP2
C     X3=XI(3,MSR(I))+DSP3
C     THKM =MAX(THMR(I),THKS)
C     XMIN=MIN(XMINM,X1)
C     XMAX=MAX(XMAXM,X1)
C     YMIN=MIN(YMINM,X2)
C     YMAX=MAX(YMAXM,X2)
```

```
ZMINS=MIN (ZMINM, X3)
ZMAXS=MAX (ZMAXM, X3)
20 CONTINUE
  IF (XMAXS+THKS.LT.XMINM-THKM) GO TO 40
  IF (YMAXS+THKS.LT.YMINM-THKM) GO TO 40
  IF (ZMAXS+THKS.LT.ZMINM-THKM) GO TO 40
  IF (XMAXS+THKM.LT.XMINS-THKS) GO TO 40
  IF (YMAXS+THKM.LT.YMINS-THKS) GO TO 40
  IF (ZMAXS+THKM.LT.ZMINS-THKS) GO TO 40
  ISKIP=0
  RETURN
40 ISKIP=1
  RETURN
  END
```



## APPENDIX G: User Defined Interface Friction and Conductivity

An easy-to-use user contact interface is provided in LS-DYNA where the user has the possibility to define the frictional coefficients (static and dynamic) as well as contact heat transfer conductance as functions of contact pressure, relative sliding velocity, separation and temperature. To be able to use this feature, an object version of the LS-DYNA code is required and the user must write his/her own Fortran (or C) code to define the contact parameters of interest.

In the text file `dyn21.f` that comes with the object version of LS-DYNA, the subroutines of interest are

```
subroutine usrfrc(fstt,fdyn,...)
```

for defining the frictional coefficients `fstt` (static) and `fdyn` (dynamic) and

```
subroutine usrhcon(h,...)
```

for defining the heat transfer contact conductance `h`.

We emphasize at this point that the user friction interface differs between LS-DYNA (SMP) and MPP-DYNA (MPP), for reasons that have to do with how the contacts are implemented in general. In LS-DYNA (SMP) the user is required not only to define the frictional coefficients but also to assemble and store contact forces and history, whereas in MPP-DYNA (MPP) only the frictional coefficients have to be defined.

For the friction interface (SMP and MPP) the user may associate history variables with each contact node. Unfortunately the user friction interface is currently not supported by all available contacts in LS-DYNA and MPP-DYNA, but should cover the most interesting ones. Upon request by customers new contact types can be supported.

One of the arguments to the user contact routines is the curve array `crv`, also available in the user material interface. Note that when using this array, the curve identity must be converted to an internal number or the subroutine `crvval` may be utilized. For more information, see the appendix A on user materials.

For definition of user contact parameters the user must define the keywords

**\*USER\_INTERFACE\_FRICTION**

or

**\*USER\_INTERFACE\_CONDUCTIVITY**

The card format for these two keywords are identical and can be found in other sections in this manual.

## APPENDIX G

---

There is an alternate route to defining the conductivity parameters for a user defined thermal contact. On the \*CONTACT\_...\_THERMAL\_FRICTION optional card the parameter FORMULA may be set to a negative number. This will automatically create a user defined conductivity interface and invoke reading of -FORMULA contact parameters immediately following the card including the FORMULA parameter. Note that FORMULA is related to NOC and NOCI in the \*USER\_INTERFACE\_CONDUCTIVITY keyword as

-FORMULA=NOC=NOCI.

Note that the pressure is automatically computed for each user conductivity interface, i.e., the keyword \*LOAD\_SURFACE\_STRESS is not necessary.

A sample friction subroutine is provided below for SMP.

```
      subroutine usrfrc(nosl,time,ncycle,dt2,insv,areas,xs,ys,zs,
.   lsv,ix1,ix2,ix3,ix4,aream,xx1,xx2,xx3,stfn,stf,fni,
.   dx,dy,dz,fdt2,ninput,ua,side,iisv5,niisv5,n1,n2,n3,fric1,
.   fric2,fric3,fric4,bignum,fdat,iseg,fxis,fyis,fzis,ss,tt,
.   ilbsv,stfk,frc,numnp,npc,pld,lcfst,lcfdt,temp,temp_bot,
.   temp_top,isurface)
c
c*****
c|  LIVERMORE SOFTWARE TECHNOLOGY CORPORATION   (LSTC)   |
c|  -----|
c|  COPYRIGHT © 1987-2007 JOHN O. HALLQUIST, LSTC   |
c|  ALL RIGHTS RESERVED                           |
c*****
c
c      user subroutine for interface friction control
c
c      note:  LS-DYNA uses an internal numbering system to
c             accomodate arbitrary node numbering.  to access
c             information for user node n, address array location m,
c             m=lqf(n,1). to obtain user node number, n,
c             corresponding to array address m, set n=lqfinv(m,1)
c
c      arguments:
c
c           nosl      =number of sliding interface
c           time      =current solution time
c           ncycle    =ncycle number
c           dt2       =time step size at n+1/2
c           insv      =slave node array where the nodes are stored
c                   in ls-dyna3d internal numbering.  User numbers
c                   are given by function: lqfinv(insv(ii),1)
c                   for slave node ii.
c           areas(ii) =slave node area (interface types 5&10 only) for
c                   slave node ii
c           xs(ii)    =x-coordinate slave node ii (projected)
c           ys(ii)    =y-coordinate slave node ii (projected)
c           zs(ii)    =z-coordinate slave node ii (projected)
c           lsv(ii)   =master segment number for slave node ii
c           ix1(ii), ix2(ii), ix3(ii), ix4(ii)
c                   =master segment nodes in ls-dyna3d internal
```

## APPENDIX G

```
c          numbering for slave node ii
c      aream(ii) =master segment area for slave node ii.
c      xx1(ii,4) =x-coordinates master surface (projected) for
c                  slave node ii
c      xx2(ii,4) =y-coordinates master surface (projected) for
c                  slave node ii
c      xx3(ii,4) =z-coordinates master surface (projected) for
c                  slave node ii
c      stfn      =slave node penalty stiffness
c      stf       =master segment penalty stiffness
c      fni       =normal force
c      dx,dy,dz  =relative x,y,z-displacement between slave node and
c                  master surface. Multiplying by fdt2 defines the
c                  relative velocity.
c      n1,n2,n3  =x,y, and z components of master segments normal
c                  vector
c
c*****
c      frictional coefficients defined for the contact interface
c
c      fric1     =static friction coefficient
c      fric2     =dynamic friction coefficient
c      fric3     =decay constant
c      fric4     =viscous friction coefficient (setting fric4=0
c                  turns this option off)
c
c*****
c      bignum    =0.0 for one way surface to surface and
c                  for surface to surface, and 1.e+10 for nodes
c                  to surface contact
c      ninput    =number of variables input into ua
c      ua(*)     =users' array, first ninput locations
c                  defined by user. the length of this
c                  array is defined on control card 10.
c                  this array is unique to interface nosl.
c
c      side      ='master' for first pass. the master
c                  surface is the surface designated in the
c                  input
c                  ='slave' for second pass after slave and
c                  master surfaces have be switched for
c                  the type 3 symmetric interface treatment.
c
c      iisv5     =an array giving the pointers to the active nodes
c                  in the arrays.
c
c      niisv5    =number of active nodes
c
c      fdat      =contact history data array
c      iseg      =contact master segment from previous step.
c      fxis      =slave node force component in global x dir.
c                  to be updated to include friction
c      fyis      =slave node force component in global y dir.
c                  to be updated to include friction
c      fzis      =slave node force component in global z dir.
c                  to be updated to include friction
```

# APPENDIX G

---

```
c      ss(ii)      =s contact point (-1 to 1) in parametric coordinates
c                  for slave node ii.
c      tt(ii)      =t contact point (-1 to 1) in parametric coordinates
c                  for slave node ii.
c      ilbsv(ii)   =pointer for node ii into global arrays.
c      stfk(ii)    =penalty stiffness for slave node ii which was used
c                  to compute normal interface force.
c      frc(1,lsv(ii))
c                  =Coulomb friction scale factor for segment lsv(ii)
c      frc(2,lsv(ii))
c                  =viscous friction scale factor for segment lsv(ii)
c
c*****
c      parameters for a coupled thermal-mechanical contact
c
c      numnp       = number of nodal points in the model
c      npc         = load curve pointer
c      pld         = load curve (x,y) data
c      lcfst(nosl)= load curve number for static coefficient of
c                  friction versus temperture for contact
c                  surface nosl
c      lcfdt(nosl)= load curve number for dynamic coefficient of
c                  friction versus temperture for contact
c                  surface nosl
c      temp(j)     = temperature for node point j
c      temp_bot(j)= temperature for thick thermal shell bottom
c                  surface
c      temp_top(j)= temperature for thick thermal shell top
c                  surface
c      numsh12     = number of thick thermal shells
c      itopaz(1)   = 999 ==> thermal-mechanical analysis
c      isurface    = thick thermal shell surface pointer
c
c*****
```



## APPENDIX H: User Defined Thermal Material Model

The addition of a thermal user material routine into LS-DYNA is fairly straightforward. The thermal user material is controlled using the keyword `*MAT_THERMAL_USER_DEFINED`, which is described at the appropriate place in the manual.

The thermal user material can be used alone or in conjunction with any given mechanical material model in a coupled thermal-mechanical solution. A heat-source can be included and the specific heat updated so that it possible to model e.g. phase transformations including melt energy.

If for the same part (shell or solid elements) both a thermal and mechanical user material model is defined then the two user material models have (optionally) read access to each other's history variables. If the integration points of the thermal and mechanical elements not are coincident then interpolation or extrapolation is used when reading history variables. Linear interpolation or extrapolation using history data from the two closest integration points is used in all cases except when reading history variables from the thick thermal shell (`THSHEL=1` on `*CONTROL_SHELL`). For the latter thermal shell, the shape functions of the element are used for the interpolation or extrapolation.

The thermal user materials are thermal material types 11-15. These thermal user material subroutines are defined in file `dyn21.f` as subroutines `thumat11`, ... , `thumat15`. The latter subroutines are called from the subroutine `thusrmat`. The source code of subroutine `thusrmat` is also in file `dyn21.f`. Additional useful information is available in the comments of subroutines `thusrmat`, `thumat12`, and `umat46` that all reside in the source file `dyn21.f`

### Thermal history variables

Thermal history variables can be used by setting `NVH` greater than 0. Thermal history variables are output to the `tprint` file, see `*DATABASE_TPRINT`.

### Interchange of history variables with mechanical user material

In a coupled thermo-mechanical solution there is for each mechanical shell, thick shell, or solid element a corresponding thermal element. A pair consisting of a mechanical and a corresponding thermal element both have integration points and possibly history variables. The mechanical and thermal elements do not necessarily have the same number of integration points.

By setting `IHVE` to 1, a thermal user material model can read, but not write, the history variables from a mechanical user material model and vice versa.

If the locations of the points where the history variables are located differ between the mechanical and thermal element interpolation or extrapolation is used to calculate the history value. More information is available in the comments to the subroutines `thusrmat` and `thumat11`.

### Limitations

# APPENDIX H

---

Currently there are a few limitations of the thermal user material implementation. LS-DYNA will in most cases give an appropriate warning or error message when such a limit is violated. The limitations include:

1. Option IHVE.EQ.1 is only supported for a limited range of mechanical elements:  
Solid elements: ELFORM=1, 2, 10, 13.  
Shell elements: ELFORM=2, 3, 4, 16. Note that user-defined integration rules are not supported.
2. Thermal history variables limitations:  
  
Thermal history variables are not output to d3plot.
3. The thermal solver includes not only the plastically dissipated energy as a heat source but also wrongly the elastic energy. The latter however is in most cases not of practical importance.

## Example source code

Example source code for thermal user material models is available in thumat11 and thumat12 as well as in umat46. Note that there is space for up to 64 material parameters in r\_matp (material parameter array) but only 32 can be read in from the \*MAT\_THERMAL\_USER\_DEFINED card. The material parameters in r\_matp(i), i=41-64, which are initially set to 0.0, may be used by the user to store additional data.

Subroutine crvval evaluates load curves. Note that when using crvval the load curves are first re-interpolated to 100 equidistant points. See Appendix A for more information on subroutine crvval.

Following is a short thermal user material model. The card format is in this case, if enabling orthotropic conduction, and with sample input in SI-units:

## \*MAT\_THERMAL\_USER\_DEFINED

Card 1            1            2            3            4            5            6            7            8

Variable	MID	RO	MT	LMC	NVH	AOPT	IORTHO	IHVE
Type	21	7800.0	12.0	6.0	3.0	0.0	1.0	0.0

# APPENDIX H

Card 2            1            2            3            4            5            6            7            8

Variable	XP	YP	ZP	A1	A2	A3		
Type	0.0	0.0	0.0	0.0	0.0	0.0		

Card 3            1            2            3            4            5            6            7            8

Variable	D1	D2	D3					
Type	0.0	0.0	0.0					

Card 4            1            2            3            4            5            6            7            8

Variable	C1	C2	C3	HC	HSRC	HCFAC		
Type	25.0	25.0	20.0	470.0	11.0	12.0		

**VARIABLE**

**DESCRIPTION**

C1-C3	Heat conduction in 11, 22, and 33 direction of material coordinate system.
HC	Heat capacity
HSRC	Load curve ID of load curve giving a heat source output (W/m3) as a function of time.
HCFAC	Load curve ID of load curve giving a scaling of the heat capacity as function of time.

The source code is:

```

subroutine thumat12(c1,c2,c3,cv1,dcvdt1,hsrcl,dhsrctl,
1   hsv,hsvm,nmecon,r_matp,crv,
2   nel,nep,iép,eltype,dt,atime,ihsrcl)
character(*) eltype

```

## APPENDIX H

---

```
dimension hsv(*),hsvm(*),r_matp(*),crv(101,2,*)
include 'iounits.inc'

c
c Thermal user-material number 12.
c
c See comments at the beginning of subroutine thusrmat
c for instructions.
c
c Example: isotropic/orthotropic material with k1=P1 and
c cvl=P2 for solid and shell elements including optional
c change of heat capacity and a heat source, both functions
c of time input as load curves.
c
c Print out some info on start-up, use material parameter 64
c as a flag.
if(nint(r_matp(64)).eq.0) then
  r_matp(64)=1.
  write(*,1200) (r_matp(8+i),i=1,6)
  write(iohsp,1200) (r_matp(8+i),i=1,6)
  write(59,1200) (r_matp(8+i),i=1,6)
endif

c
c Calculate response
c1=r_matp(8+1)
c2=r_matp(8+2)
c3=r_matp(8+3)
cvl=r_matp(8+4)
dcvdtl=0.0
eid=nint(r_matp(8+6))
if(nint(eid).gt.0) then
  call crvval(crv,eid,atime,cvlfac,tmp1)
  cvl=cvl*cvlfac
  dcvdtl=0.0
endif

c
c If flux or time step calculation then we are done.
if(eltype.eq.'solidt'.or.eltype.eq.'flux'.or.
.  eltype.eq.'shelldt') return
eid=nint(r_matp(8+5))
if(nint(eid).gt.0) then
  ihsrcl=1
  call crvval(crv,eid,atime,hsrcl,tmp1)
  dhsrcl=0.0
endif

c
c Update history variables
hsv(1)=cvl
hsv(2)=atime
hsv(3)=hsv(3)+1.0

c
c Done
return
1200 format('This is thermal user defined material #12. '/
1      '/' Material parameter c1-c3      : ',3E10.3
2      '/' Material parameter hc        : ',E10.3
3      '/' Heat source load curve       : ',F10.0
4      '/' hc scale factor load curve    : ',F10.0
```

```
5      /' Thermal History variable 1      : cv'  
6      /' Thermal History variable 2-3    : Dummy' /)  
      return  
      end
```



## APPENDIX I: Occupant Simulation Including the Coupling to Programs CAL3D and MADYMO

### INTRODUCTION

LS-DYNA is coupled to occupant simulation codes to generate solutions in automotive crashworthiness that include occupants interacting with the automotive structure. In such applications LS-DYNA provides the simulation of the structural and deformable aspects of the model and the OSP (Occupant Simulation Program) simulates the motion of the occupant. There is some overlap between the two programs which provides flexibility in the modeling approach. For example, both the OSP and LS-DYNA have the capability of modeling seat belts and other deformable restraints. The advantage of using the OSP is related to the considerable databases and expertise that have been developed in the past for simulating dummy behavior using these programs.

The development of the interface provided LSTC a number of possible approaches. The approach selected is consistent with the LSTC philosophy of providing the most flexible and useful interface possible. This is important because the field of non-linear mechanics is evolving rapidly and techniques which are used today are frequently rendered obsolete by improved methodologies and lower cost computing which allows more rigorous techniques to be used. This does make the learning somewhat more difficult as there is not any single procedure for performing a coupling.

One characteristic of LS-DYNA is the large number of capabilities, particularly those associated with rigid bodies. This creates both an opportunity and a difficulty: LSDYNA3D has many ways approximating different aspects of problems, but they are frequently not obvious to users without considerable experience. Therefore, in this Appendix we emphasize modeling methods rather than simply listing capabilities.

### THE LS-DYNA/OCCUPANT SIMULATION PROGRAM LINK

Coupling between the OSP and LS-DYNA is performed by combining the programs into a single executable. In the case of CAL3D, LS-DYNA calls CAL3D as a subroutine, but in the case of MADYMO, LS-DYNA is called as a subroutine. The two programs are then integrated in parallel with the results being passed between the two until a user defined termination time is reached.

The OSP and LS-DYNA have different approaches to the time integration schemes. The OSP time integrators are based on accurate implicit integrators which are valid for large time steps which are on the order of a millisecond for the particular applications of interest here. An iterative solution is used to insure that the problem remains in equilibrium. The implicit integrators are extremely good for smoothly varying loads, however, sharp nonlinear pulses can introduce considerable error. An automatic time step size control which decreases the time step size quickly restores the accuracy for such events. The LS-DYNA time integrator is based on an explicit central difference scheme. Stability requires that the time step size be less than the

# APPENDIX I

---

highest frequency in the system. For a coarse airbag mesh, this number is on the order of 100 microseconds while an actual car crash simulation is on the order of 1 microsecond. The smallest LS-DYNA models have at least 1,000 elements. Experience indicates that the cost of a single LS-DYNA time step for a small model is at least as great as the cost of a time step in the OSP. Therefore, in the coupling, the LS-DYNA time step is used to control the entire simulation including the OSP part. This approach has negligible cost penalties and avoids questions of stability and accuracy that would result by using a subcycling scheme between the two programs. Optionally, a subcycling scheme can be used, however, the results of the analysis have to be checked with care.

LS-DYNA has a highly developed rigid body capability which is used in different parts of automobile crash simulation. In particular, components such as the engine are routinely modeled with rigid bodies. These rigid bodies have been modified so that they form the basis of the coupling procedure in LS-DYNA to the OSP.

In LS-DYNA, the geometry of a model is broken down into nodal points which identify positions in space. These nodes are then connected by elements so that the volume of a structure is identified. Each element has a “material” associated with it. If the element is deformable, then the material will specify its characteristics such as density and Young’s Modulus. A crash model can consist of 100 or more separate materials which are each assigned a “material number,” and each material number has an associated “material type” which determines if it is elastic, plastic, viscoelastic, orthotropic, etc.

The material type may also specify that it is a rigid body. In this case, all elements of the same material number are treated as a single rigid body. These elements are integrated to determine the mass, centroid and moments of inertia for the group. This group is then treated as a rigid body with six degrees-of-freedom including three translations and three rotations. The positions of the rigid bodies are updated in LS-DYNA by a time integrator which works together with the central difference time integration.

There is an additional flag which specifies that the LS-DYNA rigid body is coupled to an OSP rigid body. This flag can be found in the description of the rigid body material \*MAT\_RIGID (formerly material type 20). In coupled updates, the OSP rigid body time integrator takes over control of the LS-DYNA rigid body and the normal LS-DYNA updates are bypassed. The time integration procedure is then as follows:

1. At the beginning of a step, LS-DYNA determines the locations and updates the positions of all of the rigid bodies which are coupled to the OSP. This information is obtained from common block information in the OSP.
2. Using the information on rigid body locations, LS-DYNA proceeds to update the stresses and history variables of all of the deformable structures and computes the resultant forces acting on all rigid bodies.
3. The resultant forces are stored into an OSP common block along with the current time step. Control is then returned to the OSP so that the step can be completed by the OSP determining the new positions of the rigid bodies based on the applied forces.



At the end of the calculation LS-DYNA terminates normally, closing its files, and then control is returned to OSP which will also terminate normally. The termination time for the coupled run is taken as the minimum of the termination time provided to LS-DYNA and the termination time provided to the OSP.

The executable for the coupling with MADYMO currently needs to be specially created at each site. TNO provides all of the appropriate load modules with their libraries, and the appropriate load modules for LS-DYNA may be obtained by the corporate contact point at the LS-DYNA distributor. A complete executable must then be made by linking the two libraries. A revised password file must be obtained from TNO prior to running the coupled code. Coupling with CAL3D requires special on-site modification of the client's CAL3D version to eliminate conflicting I/O unit numbers and to ensure that the common block lengths between the codes are consistent. LSTC does not distribute or support CAL3D.

To make the coupled program run, an input deck must be provided to both the OSP and LS-DYNA. The two input decks must be provided in the same set of consistent units. This can potentially require a major conversion to either the OSP input or the LS-DYNA input. With two legitimate and consistent input decks, the coupled program should run to completion with no problems. Additional inputs are required to make the models interact between the OSP and LS-DYNA portions of the run.

The simplest form of a coupled simulation is simply to include a single body in an OSP run. No special modifications are needed to the OSP input deck for use in the coupled simulation. Ellipsoids and planes in the OSP are usually attached to "segments" which correspond to LS-DYNA "rigid bodies." Because the coupling procedure works on the basis of shared information on LS-DYNA rigid bodies with the OSP segments, the ellipsoids/planes listed in the OSP section must correspond to the segments which are to be coupled. These ellipsoids and planes may be actual geometry which is used for contact, or they may be simply artificial shapes to permit the data transfer between the OSP and LS-DYNA.

## DUMMY MODELING

The dummy is typically modeled entirely within the OSP. The coupling of the dummy into LS-DYNA requires the creation of a separate LS-DYNA rigid body material for each segment of the OSP. The easiest way to create a mesh for the model is to set the LS-DYNA rigid body coupling option to 2.0. This causes LS-DYNA to search all of the ellipsoids connected to the appropriate segment and generate meshes which are then slaved to the OSP dummy. Thus, with minimal input, a complete dummy may be generated and the kinematics may be traced in LS-DYNA and displayed in the LS-DYNA post-processor, LS-PREPOST.

Once the basic dummy coupling has been accomplished, the deformable finite element structure can be added. Assuming that an ellipsoid is available for the steering wheel, a flat airbag can be added in the proper location. One or more nodes must be attached to the steering wheel. This is done by identifying the attached nodes as "Extra Nodes for Rigid Body" which is input in LS-DYNA by \*CONSTRAINED\_EXTRA\_NODES\_Option. The nodes are slaved to the LS-DYNA material which has been coupled to the MADYMO steering wheel model. Contact

# APPENDIX I

---

must now be identified between the airbag and the steering wheel, the windshield, and the various body parts which may be affected. This requires the use of one geometric contact entity (see \*CONTACT\_ENTITY) for each plane or ellipsoid which may interact with the airbag. A control volume specifying inflation properties for the airbag must be specified (see \*AIRBAG\_OPTION) to complete the model.

## AIRBAG MODELING

Modeling of airbags is accomplished by use of shell or membrane elements in conjunction with a control volume (see \*AIRBAG\_OPTION) and possibly a single surface contact algorithm to eliminate interpenetrations during the inflation phase (see \*CONTACT\_OPTION). The contact types showing an “a” in front are most suited for airbag analysis. Current recommended material types for the airbags are:

- |                                  |  |
|----------------------------------|--|
| *MAT_ELASTIC = Type 1.           | Elastic                                    |
| *MAT_COMPOSITE_DAMAGE = Type 22. | Layered orthotropic elastic for composites |
| *MAT_FABRIC = Type 34.           | Fabric model for folded airbags            |

Model 34 is a “fabric” model which can be used for flat bags. As a user option this model may or may not support compression.

The elements which can be used are as follows:

Belytschko-Tsay quadrilateral with 1 point quadrature. This element behaves rather well for folded and unfolded cases with only a small tendency to hourglass. The element tends to be a little stiff. Stiffness form hourglass control is recommended.

Belytschko-Tsay membrane. This model is softer than the normal Belytschko-Tsay element and can hourglass quite badly. Stiffness form hourglass is recommended. As a better option, the fully integrated Belytschko-Tsay membrane element can be chosen.

C0 Triangular element. The C0 triangle is very good for flat bag inflation and has no tendency to hourglass.

The best choice is a specially developed airbag membrane element with quadrilateral shape. This is an automatic choice when the fabric material is used.

As an airbag inflates, a considerable amount of energy is transferred to the surrounding air. This energy transfer decreases the kinetic energy of the bag as it inflates. In the control volume logic, this is simulated either by using either a mass weighted damping option or a back pressure on the bag based on a stagnation pressure. In both cases, the energy that is absorbed is a function of the fabric velocity relative to a rigid body velocity for the bag. For the mass weighted case, the damping force on a node is proportional to the mass times the damping factor times the velocity vector. This is quite effective in maintaining a stable system, but has little physical justification.

The latter approach using the stagnation pressure method estimates the pressure needed to accelerate the surrounding air to the speed of the fabric. The formula for this is:

$$P = \text{Area} \times \alpha \times \left( (\vec{V}_i - \vec{V}_{cg}) \cdot \hat{n} \right)^2$$

This formula accomplishes a similar function and has a physical justification. Values of the damping factor,  $\alpha$ , are limited to the range of 0 to 1, but a value of 0.1 or less is more likely to be a good value.

## KNEE BOLSTER

The knee-to-knee bolster interactions are characterized by the stiffness of the knee being comparable to that of the knee bolster. Therefore, modeling the knee as a rigid body may produce large errors in the interaction forces. Calibrated force-deflection curves could be determined, but they would have no predictive value for slight changes to knee bolster designs. For this reason, a more accurate modeling of the compliance of the knee bolster and the knee is required.

The knee can be modeled as a combined rigid/deformable body. The rigid body is coupled to the OSP. Overlaying the rigid body are brick elements which model the “skin” that exists over the knees of the dummy. These brick elements use material type 6 (\*MAT\_VISCOELASTIC) which is a viscoelastic model that does a reasonable job of approximating the hysteretic behavior of rubbers. The inner layer of the brick elements is attached to the rigid body through the \*CONSTRAINED\_EXTRA\_NODES Option. Between the knee bolster is a SURFACE-TO-SURFACE contact definition.

## COMMON ERRORS

### 1. Improper airbag inflation or no inflation.

The most common problem is inconsistency in the units used for the input constants. An inflation load curve must also be specified. The normals for the airbag segments must all be consistent and facing outwards. If a negative volume results, this can sometimes be quickly cured by using the “flip” flag on the control volume definition to force inward facing normals to face outwards.

### 2. Excessive airbag distortions.

Check the material constants. Triangular elements should have less distortion problems than quadrilaterals. Overlapped elements at time zero can cause locking to occur in the contact leading to excessive distortions. The considerable energy input to the bag will create numerical noise and some damping is recommended to avoid problems.

# APPENDIX I

---

## 3. The dummy passes through the airbag.

A most likely problem is that the contacts are improperly defined. Another possibility is that the models were developed in an incompatible unit system. The extra check for penetration flag if set to 1 on the contact control cards variable PENCHK in the \*CONTACT\_... definitions may sometimes cause nodes to be prematurely released due to the softness of the penalties. In this case the flag should be turned off.

## 4. The OSP fails to converge.

This may occur when excessively large forces are passed to the OSP. First, check that unit systems are consistent and then look for improperly defined contacts in the LS-DYNA input.

## 5. Time step approaches zero.

This is almost always in the airbag. If elastic or orthotropic (\*MAT\_ELASTIC or \*MAT\_COMPOSITE material 1 or 22) is being used, then switch to fabric material \*MAT\_FABRIC which is less time step size sensitive and use the fully integrated membrane element. Increasing the damping in the control volume usually helps considerably. Also, check for “cuts” in the airbag where nodes are not merged. These can allow elements to deform freely and cut the time step to zero.

**APPENDIX J: Interactive Graphics Commands**

Only the first four or less characters of command are significant. These commands are available in the interactive phase of LS-DYNA. The interactive graphics are available by using the "SW5." command after invoking the Ctrl-C interrupt. The MENU command brings up a push button menu. Only available in Unix and Linux.

ANIMATE	Animate saved sequence, stop with switch 1.
BACK	Return to previous display size after zoom, then list display attributes.
BGC	Change display background color RGB proportions BGC <red> <green> <blue>.
BIP	Select beam integration point for contour; BIP <#>.
CENTER	Center model, center on node, or center with mouse, i.e., center cent <value> or cent gin.
CL	Classification labels on display; class commercial_in_confidence.
CMA	Color materials on limited color displays.
COLOR	Set or unset shaded coloring of materials.
CONTOUR	View with colored contour lines; contour <component #> <list mat #>; see TAURUS manual.
COOR	Get node information with mouse.
COP	Hardcopy of display on the PC copy <laserj paintj tekcol coljet or epson>.
CR	Restores cutting plane to default position.
CUT	Cut away model outside of zoom window; use mouse to set zoom window size.
CX	Rotate slice plane at zmin about x axis.
CY	Rotate slice plane at zmin about y axis.
CZ	Rotate slice plane at zmin about z axis.
DIF	Change diffused light level for material; DIF <mat #, -1 for all> <value>.

## APPENDIX J

---

DISTANCE	Set distance of model from viewer; DIST <value in normalized model dimensions>.
DMATERIALS	Delete display of material in subsequent views; DMAT <ALL or list of numbers>.
DRAW	Display outside edges of model.
DSCALE	Scale current displacement from initial shape.
DYN	After using TAURUS command will reset display to read current DYNA3D state data.
ELPLT	Set or unset element numbering in subsequent views.
END	Delete display and return to execution.
ESCAPE	Escapes from menu pad mode.
EXECUTE	Return to execution and keep display active.
FCL	Fix or unfix current contour levels.
FOV	Set display field of view angle; FOV <value in degrees>.
FRINGE	View with colored contour fringes; fringe <component #> <list mat #>; see TAURUS manual.
GETFRAME	Display a saved frame; GETF <frame #>.
HARDWARE	Hardware mode; workstation hardware calls are used to draw, move and color model; repeat command to reset to normal mode.
HELP	
HZB	Switch on or off hardware zbuffer for a subsequent view, draw or contour command; rotations and translations will be in hardware.
LIMIT	Set range of node numbers subsequent views; limit <first node #> <last node #>.
MAT	Re-enable display of deleted materials mat <all or list of numbers>.
MENU	Button menu pad mode.

MOTION	Motion of model through mouse movement or use of a dial box. The left button down enables translation in the plane, middle button rotation about axes in the plane; and with right button down in the out of plane axis; left and middle button down quit this mode.
MOV	Drag picked part to new position set with mouse.
NDPLT	Set or unset node numbering in subsequent views.
NOFRAME	Set and unset drawing of a frame around the picture.
PAUSE	Animation display pause in seconds
PHS2 or THISTORY	Time history plotting phase. Similar to LS-TAURUS.
PICK	Get element information with mouse.
POST	Enable or disable postscript mode on the PC and eps file is written as picture is drawn; remove eofs and initgraphics for eps use.
QUIT	Same as execute.
RANGE	Set fix range for contour levels; range <minvalue> <maxvalue>.
RAX	Reflect model about xy plane; restore command will switch-off reflections.
RAY	Reflect model about yz plane; restore command will switch-off reflections.
RAZ	Reflect model about zx plane, restore command will switch-off reflections.
RESTORE	Restores model to original position, also switches off element and node numbers, slice capper, reflections and cut model.
RETURN	Exit.
RGB	Change color red green blue element <mat #> <red> <green> <blue>.
RX	Rotate model about x axis.
RY	Rotate model about y axis.

## APPENDIX J

---

RZ	Rotate model about z axis.
SAVE	Set or unset saving of display for animation.
SEQUENCE	Periodic plot during execution; SEQ <# of cycles> <commands> EXE.
SHR	Shrink element facets towards centroids in subsequent views, shrink <value>.
SIP	Select shell integration point for contour; SIP <#>.
SLICE	Slice model a z-minimum plane; slice <value in normalized model dimension> this feature is removed after using restore. Slice enables internal details for brick elements to be used to generate new polygons on the slice plane.
SNORMAL	Set or unset display of shell direction normals to indicate topology order.
SPOT	Draw node numbers on model spot <first #> <last # for range>.
TAURUS	LS-DYNA database, TAU <state #>, or state <state #>, reads LS-TAURUS file to extract previous state data.
TRIAD	Set or unset display of axis triad.
TSHELL	Set or unset shell element thickness simulation in subsequent views.
TV	Change display type.
TX	Translates model along x axis.
TY	Translates model along y axis.
TZ	Translates model along z axis.
V	Display model using painters algorithm.
VECTOR v or d	View with vector arrows of velocity or displacement; <v> or <d>.
ZB	Switch on or off zbuffer algorithm for subsequent view; or draw commands.
ZIN	Zoom in using mouse to set display size and position.
ZMA	Set position of zmax plane; ZMAX <value in normalized model dimensions>.
ZMI	Set position of zmin plane; ZMIN <value in normalized model dimensions>.



ZOUT

Zoom out using mouse to set displays size expansion and position.



**APPENDIX K: Interactive Material Model Driver****INTRODUCTION**

The interactive material model driver in LS-DYNA allows calculation of the material constitutive response to a specified strain path. Since the constitutive model subroutines in LS-DYNA are directly called by this driver, the behavior of the constitutive model is precisely that which can be expected in actual applications. In the current implementation the constitutive subroutines for both shell elements and solid elements can be examined.

**INPUT DEFINITION**

The material model driver is invoked when no \*NODE or \*ELEMENT commands are present in a standard LS-DYNA input file. The number of material model definitions should be set to one, the number of load curves should be nine, and the termination time to the desired length of the driver run. The complete state dump interval as given in \*DATABASE\_BINARY\_D3PLOT serves as the time step to be used in the material model driver run. Plotting information is saved in core for the interactive plotting phase.

The input deck typically consists only of \*KEYWORD, \*DATABASE\_BINARY\_D3PLOT, \*CONTROL\_TERMINATION, one each of \*PART/\*MAT/\*SECTION, and nine load curves (\*DEFINE\_CURVE) describing the strain path. These nine curves define the time history of the displacement gradient components shown in Table K.1.

The velocity gradient matrix,  $L_{ij}$ , is approximated by taking the time derivative of the components in Table K.1. If these components are considered to form a tensor  $S_{ij}$ , then

$$L_{ij}(t) = \frac{S_{ij}(t) - S_{ij}(t_{k-1})}{(t - t_k)}$$

and the strain rate tensor is defined as

$$d_{ij} = \frac{L_{ij} + L_{ij}^t}{2}$$

and the spin tensor as

$$\omega_{ij} = \frac{L_{ij} - L_{ij}^t}{2}$$

# APPENDIX K

---

Load Curve Number	Component Definition
1	$\frac{\partial u}{\partial x}$
2	$\frac{\partial v}{\partial y}$
3	$\frac{\partial w}{\partial z}$
4	$\frac{\partial u}{\partial y}$
5	$\frac{\partial v}{\partial x}$
6	$\frac{\partial u}{\partial z}$
7	$\frac{\partial w}{\partial x}$
8	$\frac{\partial v}{\partial z}$
9	$\frac{\partial w}{\partial y}$

**Table K.1** Load Curve Definitions versus Time

## INTERACTIVE DRIVER COMMANDS

After reading the input file and completing the calculations, LS-DYNA gives a command prompt to the terminal. A summary of the available interactive commands is given below. An on-line help package is available by typing HELP. Only available in Unix and Linux.

ACCL	Scale all abscissa data by f. Default is f=1.
ASET amin omax	Set min and max values on abscissa to amin and amax, respectively. If amin=amax=0, scaling is automatic.
CHGL n	Change label for component n. LS-DYNA prompts for new label.

CONTINUE	Re-analyze material model.
CROSS $c_1$ $c_2$	Plot component $c_1$ versus $c_2$ .
ECOMP	Display component numbers on the graphics display: 1 x-stress, 2 y-stress, 3 z-stress, 4 xy-stress, 5 yz-stress, 6 zx-stress, 7 effective plastic strain, 8 pressure, 9 von Mises (effective) stress, 10 1st principal deviatoric stress, 11 2nd principal deviatoric stress, 12 3rd principal deviatoric stress, 13 maximum shear stress, 14 1st principal stress, 15 2nd principal stress, 16 3rd principal stress, 17 $\ln(v/v_0)$ , 18 relative volume, 19 $v_0/v - 1.0$ , 20 1st history variable, 21 2nd history variable.  Adding 100 or 400 to component numbers 1-16 yields strains and strain rates, respectively.
FILE name	Change pampers filename to name for printing.
GRID	Graphics displays will be overlaid by a grid of orthogonal lines.
NOGRID	Graphics displays will not be overlaid by a grid of orthogonal lines.
OSCL	Scale all ordinate data by f. Default is $f=1$ .
OSET $omin$ $omax$	Set min and max values on ordinate to $omin$ and $omax$ , respectively. If $omin=omax=0$ , scaling is automatic.
PRINT	Print plotted time history data into file "pampers." Only data plotted after this command is printed. File name can be changed with the "file" command.
QUIT, END, T	Exit the material model driver program.

## APPENDIX K

---

RDLC m n r<sub>1</sub> z<sub>1</sub> ... r<sub>n</sub> z<sub>n</sub>

Redefine load curve m using n coordinate pairs (r<sub>1</sub>,z<sub>1</sub>) (r<sub>2</sub>,z<sub>2</sub>),... (r<sub>n</sub>,z<sub>n</sub>).

TIME c

Plot component c versus time.

TV n

Use terminal output device type n. LS-DYNA provides a list of available devices.

Presently, the material model driver is implemented for solid and shell element material models. The driver does not yet support material models for beam elements.

## APPENDIX L: VDA Database

VDA surfaces describe the surface of geometric entities and are useful for the simulation of sheet forming problems. The German automobile and automotive supplier industry (VDA) has defined the VDA guidelines [VDA 1987] for a proper surface definition used for the exchange of surface data information. In LS-DYNA, this format can be read and used directly. Some files have to be provided for proper linkage to the motion of the correlation parts/materials in LS-DYNA.

Linking is performed via names. To these names surfaces are attached, which in turn can be linked together from many files externally to LS-DYNA. Thus, arbitrary surfaces can be provided by a preprocessor and then can be written to various files. The so-called VDA file given on the LS-DYNA execution line via `V=vda` contains references to all other files. It also contains several other parameters affecting the treatment in the contact subroutines; see below.

The procedure is as follows. If VDA surfaces are to be used, the file specified by `vda` must have the following form. The file is free formatted with blanks as delimiters. Note that the characters “}” and “{” must be separated from the other input by spaces or new lines. The `vda` file may contain any number of input file specifications of the form:

```
file afile bfile {
    alias definitions
    }
    alias definitions
```

followed by optional runtime parameters and a final end statement.

The file, `afile`, is optional, and if given must be the name of an ASCII input file formatted in accordance with the VDA Surface Interface Definitions as defined by the German automobile and automotive supply industry. `bfile` is required, and is the name of a binary VDA file. In a first run `afile` is given and `bfile` is created. In any further run, if the definitions have not changed, `afile` can be dropped and only `bfile` is needed. The purpose of `bfile` is that it allows for much faster initialization if the same VDA surfaces are to be used in a future LS-DYNA run.

If `afile` is given, `bfile` will always be created or overwritten. The alias definitions are used for linking to LS-DYNA and between the various surface definitions in the files defined by `afile` and `bfile`.

The alias definitions are of the form

```
alias name { e11 e12 ... e1n }
```

where `name` is any string of up to 12 characters, and `e11,...,e1n` are the names of VDA elements as specified in `afile`. The list of elements can be empty, in which case all the SURF and FACE VDA elements in `afile` will be used. Care should be taken to ensure that the alias `name` is

# APPENDIX L

unique, not only among the other aliases, but among the VDA element names in **afile**. This collection of VDA elements can later be indicated by the alias **name**. In particular, **name** may appear in later alias definitions.

Often it is required that a punch or die be created by a simple offset. This can be achieved in the **vda** files in two ways, either on VDA elements directly, or on parts defined by aliases. This feature offers great capability in generating and using surface data information.

## Offset version 1:

As an option, the keyword **offset** may appear in the alias list which allows a new surface to be created as a normal offset (plus translation) of a VDA element in the file. The keyword **offset** may be applied to VDA elements only, not aliases. The usage of **offset** follows the form

offset elem **normal** x y z

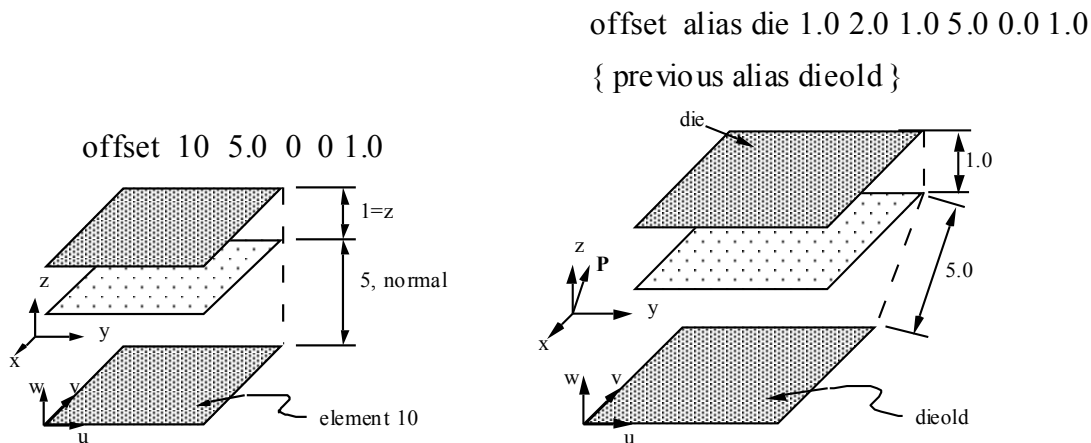
where **normal** is the amount to offset the surface along the normal direction, and **x,y,z** are the translations to be applied. The default normal direction is given by the cross product of the local u and v directions on the VDA surface, taken in that order. **normal** can be negative.

## Offset version 2:

Frequently, it is convenient to create a new alias **name** by offsetting and translating an existing **name**. The keyword **goffset** provides this function:

goffset alias\_name **x<sub>c</sub> y<sub>c</sub> z<sub>c</sub>** **normal** x y z { previous alias\_name }

where **normal**, **x**, **y**, and **z** are defined as in the offset keyword. A reference point **x<sub>c</sub>**, **y<sub>c</sub>**, and **z<sub>c</sub>** defines a point in space which determines the normal direction to the VDA surface, which is a vector from the origin to P(x<sub>c</sub>,y<sub>c</sub>,z<sub>c</sub>). See example below.





Finally, several parameters affecting the VDA surface iteration routines can be reset in the file **vda**. These parameters, and their default values in square brackets [ ], are:

- gap** [5.0]      The maximum allowable surface gap to be filled in during the iterations. Points following the surface will effectively extend the edges of surfaces if necessary to keep them from falling through cracks in the surface smaller than this. This number should be set as small as possible while still allowing correct results. In particular, if your VDA surfaces are well formed (having no gaps), this parameter can be set to 0.0. The default value is 5.0.
- track** [2.0]      A point must be within this distance of contact to be continually tracked. When a point not being tracked comes close to a surface, a global search is performed to find the near surface point. While a point is being tracked, iterations are performed every cycle. These iterations are much faster, but if the point is far away it is faster to occasionally do the global search. The default value is 2.0.
- track2** [5.0]      Every VDA surface is surrounded by a bounding box. When a global search needs to be performed but the distance from a point to this box is  $>$  **track2**, the actual global search is not performed. This will require another global search to be performed sooner than if the actual distance to the surface were known, but also allows many global searches to be skipped. The default value is 5.0.
- ntrack** [4]      The number of VDA surfaces for which each point maintains actual distance information. A global lower bound on distance is maintained for all remaining surfaces. Whenever the point moves far enough to violate this global lower bound, all VDA surfaces must have the global search performed for them. Hence, this parameter should be set to the maximum number of surfaces that any point can be expected to be near at one time (the largest number of surfaces that come together at one point). Setting **ntrack** higher will require more memory but result in faster execution. If **ntrack** is too low, performance may be unacceptably slow. The default value is 4.0.
- toroid** [.01]      Any surface with opposing edges which are within distance [t] of each other is assumed to be cylindrical. Contacts occurring on one edge can pass to the adjacent edge. The default value is 0.01.
- converge** [.01]      When surface iterations are performed to locate the near point, iteration is continued until convergence is detected to within this distance (all VDA coordinates are in mm). The default value is 0.01.

## APPENDIX L

---

**iterate** [8] Maximum number of surface iterations allowed. Since points being tracked are checked every cycle, if convergence fails it will be tried again next cycle, so setting this parameter high does not necessarily help much. On the other hand, a point converging to a crease in the VDA surface (a crease between patches with discontinuous derivative, for example) may bounce back and forth between patches up to this many times, without actually moving. Hence, this value should not be too large. The default value is 8.

**el\_size** [t mx mn]

Controls the generation of elements where:

t =surface tolerance for mesh generation,

mx=maximum element size to generate,

mn=minimum element size to generate.

The default values are [0.25 100. 1.0]

**aspect** [s1 s2] Controls the generation of elements where:

s1=maximum difference in aspect ratio between elements generated in neighboring VDA patches,

s2=maximum aspect ratio for any generated element.

The default values are [1.5 4.0]

**cp\_space** [10] Determines the spacing around the boundaries of parts at which the size of elements is controlled. In the interior of the part, the element size is a weighted function of these control points as well as additional control points in the interior of the region. If there are too few control points around the boundary, elements generated along or near straight boundaries, but between control points, may be too small. The default value is 10.

**meshonly** The existence of this keyword causes LS-DYNA to generate a file containing the mesh for the VDA surfaces and then terminate.

**onepatch** The existence of this keyword causes LS-DYNA to generate a single element on each VDA patch.

**somepatch** [n] Like onepatch, but generates an element for 1 out of every [n] patches.

Example for file V=**vda**. It contains the following data:

```
file vda1 vda1.bin {  
    alias die {
```

```
        sur0001
        sur0003
        offset fce0006 1.5 0 0 120
    }
    alias holder1 { sur008 }
}
file vda2 vda2.bin {
    alias holder2 { sur003 }
}
alias holder { holder1 holder2 }
ntrack 6
gap 0.5

end
```

## **Explanation:**

<b>vda1</b>	This file contains the surfaces/face elements sur0001,sur0003, fce0006, and sur0008.
<b>alias die face</b>	Combines the surface/face elements sur0001, sur0003, and the offsetted fce0006 to a global surface.
<b>alias holder1</b>	Defines the surface/face element sur0008 as holder1.
<b>vda2</b>	This file contains the surface/face element sur0003.
<b>alias holder2</b>	Defines the surface/face element sur0003 as holder2.
<b>alias holder</b>	Combines the surfaces holder1 and holder2 into a combined surface holder.
<b>ntrack 6</b>	For each point the actual distances to 6 VDA surfaces are maintained.
<b>gap 0.5</b>	Surface gaps of 0.5mm or less are filled.
<b>end</b>	Closes reading of this file.



## APPENDIX M: Commands for Two-Dimensional Rezoning

The rezoner in LS-DYNA contains many commands that can be broken down into the following categories:

- general,
- termination of interactive rezoning,
- redefinition of output intervals for data,
- graphics window controls,
- graphics window controls for x versus y plots,
- mesh display options,
- mesh modifications,
- boundary modifications,
- MAZE line definitions,
- calculation graphics display control parameters,
- calculation graphics display,
- cursor commands.

The use of the rezoner is quite simple. Commands for rezoning material number *n* can be invoked after the material is specified by the “M *n*” command. To view material *n*, the command “V” is available. The interior mesh can be smoothed with the “S” command and the boundary nodes can be adjusted after the “B” command is used to display the part side and boundary node numbers. Commands that are available for adjusting boundary nodes following the “B” command include:

ER, EZ, ES, VS, BD, ERS, EZS, ESS, VSS, BDS, SLN, SLNS

Rezoning is performed material by material. An example is shown.

Do not include the graphics display type number (see the “TV” command below) when setting up a command file for periodic noninteractive rezoning. No plotting is done when the rezoner is used in this mode.

# APPENDIX M

---

## REZONING COMMANDS BY FUNCTION

### Interactive Real Time Graphics

---

SEQ n commands EXE      Every n time steps execute the graphics commands which follow. For example the line seq 100 g exe would cause the grid to be updated on the graphics display device every 100 cycles. The real time graphics can be terminated by using ctrl-c and typing "sw7."

### General

---

C                              Comment - proceed to next line.

FRAME                        Frame plots with a reference grid (default).

HELP                         Enter HELP package and display all available commands. Description of each command is available in the HELP package.

HELP/commandname        Do not enter HELP package but print out the description on the terminal of the command following the slash.

LOGO                        Put LLNL logo on all plots (default). Retyping this command removes the logo.

NOFRAME                    Do not plot a reference grid.

PHP ans                    Print help package - If answer equals 'y' the package is printed in the high speed printer file.

RESO  $n_x$   $n_y$             Set the x and y resolutions of plots to  $n_x$  and  $n_y$ , respectively. We default both  $n_x$  and  $n_y$  to 1024.

TV n                        Use graphics output device type n. The types are installation dependent and a list will be provided after this command is invoked.

TR t                        At time t, LS-DYNA will stop and enter interactive rezoning phase.

### Termination of Interactive Rezoning

---

F                              Terminate interactive phase, remap, continue in execution phase.

FR	Terminate interactive phase, remap, write restart dump, and call exit.
T or END	Terminate.

## Redefinition of Output Intervals for Data

---

PLTI $\Delta t$	Reset the node and element data dump interval $\Delta t$ .
PRTI $\Delta t$	Reset the node and element printout interval $\Delta t$ .
TERM t	Reset the termination to t.

## Graphics Window Controls

---

ESET n	Center picture at element n with a $\Delta r$ by $\Delta z$ window. This window is set until it is released by the unfix command or reset with another window.
FF	Encircle picture with reference grid with tickmarks. Default grid is plotted along bottom and left side of picture.
FIX	Set the display to its current window. This window is set until it is reset by the “GSET”, “FSET”, or “SETF” commands or released by the “UNFIX” command.
FSET n $\Delta r$ $\Delta z$	Center display at node n with a rectangular $\Delta r \times \Delta z$ window. This window is set until it is reset with or the “UNFIX” command is typed.
GSET r z $\Delta l$	Center display picture at point (r,z) with square window of width $\Delta l$ . This window is set until it is reset or the “UNFIX” command is typed.
GRID	Overlay graphics displays with a grid of orthogonal lines.
NOGRID	Do not overlay graphics displays with a grid of orthogonal lines (default).
SETF r z $\Delta r$ $\Delta z$	Center display at point (r,z) with a rectangular $\Delta r \times \Delta z$ window. This window is set until it is reset or the “UNFIX” command is typed.
UNFIX	Release current display window set by the “FIX”, “GSET”, “FSET” or “SETF” commands.

## APPENDIX M

---

UZ a b $\Delta l$	Zoom in at point (a,b) with window $\Delta l$ where a, b, and $\Delta l$ are numbers between 0 and 1. The picture is assumed to lie in a unit square.
UZG	Cover currently displayed picture with a 10 by 10 square grid to aid in zooming with the unity zoom, “UZ”, command.
UZOU a b $\Delta l$	Zoom out at point (a,b) with window $\Delta l$ where a, b, and $\Delta l$ are numbers between 0 and 1. The current window is scaled by the factor $1/\Delta l$ . The picture is assumed to lie in a unit square.
Z r z $\Delta l$	Zoom in at point (r,z) with window $\Delta l$ .
ZOUT r z $\Delta l$	Zoom out at point (r,z) with window $\Delta l$ . The window is enlarged by the ratio of the current window and $\Delta l$ . The cursor may be used to zoom out via the cursor command DZOU and entering two points with the cursor to define the window. The ratio of the current window with the specified window determines the picture size reduction. An alternative cursor command, DZZO, may be used and only needs one point to be entered at the location where the reduction (2 $\times$ ) is expected.

### Graphics Window Controls for x versus y plots

---

The following commands apply to line plots, interface plots, etc.

ASCL $f_a$	Scale all abscissa data by $f_a$ . The default is $f_a = 1$ .
ASET amin amax	Set minimum and maximum values on abscissa to amin and amax, respectively. If amin=amax=0.0 (default) LS-DYNA determines the minimum and maximum values.
OSCL $f_o$	Scale all ordinate data by $f_o$ . The default is $f_o = 1$ .
OSET omin omx	Set minimum and maximum values on ordinate to omin and omx, respectively. If omin=omx=0.0 (default) LS-DYNA determines the minimum and maximum values.
SMOOTH n	Smooth a data curve by replacing each data point by the average of the 2n adjacent points. The default is n=0.

### Mesh Display Options

---

ELPLT	Plot element numbers on mesh of material n.
FSOFF	Turn off the “FSON” command.



FSON	Plot only free surfaces and slideline interfaces with “O” command. (Must be used before “O” command.)
G	View mesh.
GO	View mesh right of centerline and outline left of centerline.
GS	View mesh and solid fill elements to identify materials by color.
M n	Material n is to be rezoned.
MNOFF	Do not plot material numbers with the “O”, “G”, and “GO” commands (default).
MNON	Plot material numbers with “O”, “G”, and “GO” commands.
NDPLT	Plot node numbers on mesh of material n.
O	Plot outlines of all material.
RPHA	Reflect mesh, contour, fringe, etc., plots about horizontal axis. Retyping “RPHA” turns this option off.
RPVA	Reflect mesh, contour, fringe, etc., plots about vertical axis. Retyping “RPVA” turns this option off.
TN r z $\Delta$	Type node numbers and coordinates of all nodes within window ( $r \pm \Delta/2$ , $z \pm \Delta/2$ ).
UG	Display undeformed mesh.
V	Display material n on graphics display. See command M.
VSF	Display material n on graphics display and solid fill elements.

### Mesh Modifications

---

BACKUP	Restore mesh to its previous state. This command undoes the result of the last command.
BLEN s	Smooth option where $s=0$ and $s=1$ correspond to equipotential and isoparametric smoothing, respectively. By letting $0 \leq s \leq 1$ a combined blending is obtained.
CN m r z	Node m has new coordinate (r,z).

## APPENDIX M

---

DEB n f <sub>1</sub> l <sub>1</sub> ... f <sub>n</sub> l <sub>n</sub>	Delete n element blocks consisting of element numbers f <sub>1</sub> to l <sub>1</sub> , f <sub>2</sub> to l <sub>2</sub> ... , and f <sub>n</sub> to l <sub>n</sub> inclusive. These elements will be inactive when the calculation resume.
DE e <sub>1</sub> e <sub>2</sub>	Delete elements e <sub>1</sub> to e <sub>2</sub> .
DMB n m <sub>1</sub> m <sub>2</sub> ... m <sub>n</sub>	Delete n material blocks consisting of all elements with material numbers m <sub>1</sub> , m <sub>2</sub> ,..., and m <sub>n</sub> . These materials will be inactive when the calculations resume.
DM n m <sub>1</sub> m <sub>2</sub> ... m <sub>n</sub>	Delete n materials including m <sub>1</sub> , m <sub>2</sub> ,..., and m <sub>n</sub> .
DZER k d incr nrow	Delete element row where k is the kept element, d is the deleted element, incr is the increment, and nrow is the number of elements in the row.
DZLN number n <sub>1</sub> n <sub>2</sub> n <sub>3</sub> ...n <sub>last</sub>	Delete nodal row where number is the number of nodes in the row and n <sub>1</sub> , n <sub>2</sub> , ... n <sub>last</sub> are the ordered list of deleted nodes.
DZNR l j incr	Delete nodal row where l is the first node in the row, j is the last node in the row, and incr is the increment.
R	Restore original mesh.
S	Smooth mesh of material n. To smooth a subset of elements, a window can be set via the "GSET", "FSET", OR "SETF" commands. Only the elements lying within the window are smoothed.

### Boundary Modifications

---

A	Display all slidelines. Slave sides are plotted as dashed lines.
B	Determine boundary nodes and sides of material n and display boundary with nodes and side numbers.
BD m n	Dekink boundary from boundary node m to boundary node n (counterclockwise).
BDS s	Dekink side s.
DSL n l <sub>1</sub> l <sub>2</sub> ...l <sub>n</sub>	Delete n slidelines including slideline numbers l <sub>1</sub> l <sub>2</sub> ..., and l <sub>n</sub> .
ER m n	Equal space in r-direction boundary nodes m to n (counterclockwise).
ERS s	Equal space in the r-direction boundary nodes on side s.

ES m n	Equal space along boundary, boundary nodes m to n (counterclockwise).
ESS s	Equal space along boundary, boundary nodes on side s.
EZ m n	Equal space in z-direction boundary nodes m to n (counterclockwise).
EZS s	Equal space in the z-direction boundary nodes on side s.
MC n	Check master nodes of slideline n and put any nodes that have penetrated through the slave surface back on the slave surface.
MD n	Dekink master side of slideline n. After using this command, the SC or MC command is sometimes advisable.
MN n	Display slideline n with master node numbers.
SC n	Check slave nodes of slideline n and put any nodes that have penetrated through the master surface back on the master surface.
SD n	Dekink slave side of slideline n; after using this command, the SC or MC command is sometimes advisable.
SLN m n	Equal space boundary nodes between nodes m to n on a straight line connecting node m to n.
SLNS n	Equal space boundary nodes along side n on a straight line connecting the corner nodes.
SN n	Display slideline n with slave node numbers.
VS m n r	Vary the spacing of boundary nodes m to n such that r is the ratio of the first segment length to the last segment length.
VSS s r	Vary the spacing of boundary nodes on side s such that r is the ratio of the first segment length to the last segment length.

### **MAZE Line Definitions**

---

B	Determine boundary nodes and sides of material n and display boundary with nodes and side numbers. See command "M".
LD n k l	Line definition n for MAZE includes boundary nodes k to l
LDS n l	Line definition n for MAZE consists of side number l.

## APPENDIX M

---

M n Material n is active for the boundary command B.

### Calculation Graphics Display Control Parameters

---

MOLP Overlay the mesh on the contour, fringe, principal stress, and principal strain plots. Retyping “MOLP” turns this option off.

NLOC Do not plot letters on contour lines.

NUMCON n Plot n contour levels. The default is 9.

PLOC Plot letters on contour lines to identify their levels (default).

RANGE r<sub>1</sub> r<sub>2</sub> Set the range of levels to be between r<sub>1</sub> and r<sub>2</sub> instead of in the range chosen automatically by LS-DYNA. To deactivate this command, type RANGE 0 0.

### Calculation Graphics Display

---

CONTOUR c n m<sub>1</sub> m<sub>2</sub>...m<sub>n</sub> Contour component number c on n materials including materials m<sub>1</sub>, m<sub>2</sub>, ..., m<sub>n</sub>. If n is zero, only the outline of material m<sub>1</sub> with contours is plotted. Component numbers are given in Table M.1.

FRINGE c n m<sub>1</sub> m<sub>2</sub>...m<sub>n</sub> Fringe component number c on n materials including m<sub>1</sub>, m<sub>2</sub>,...,m<sub>n</sub>. If n is zero, only the outline of material m<sub>1</sub> with contours is plotted. Component numbers are given in Table M.1.

IFD n Begin definition of interface n. If interface n has been previously defined, this command has the effect of destroying the old definition.

IFN l m Include boundary nodes l to m (counterclockwise) in the interface definition. This command must follow the “B” command.

IFP c m Plot component c of interface m. Component numbers are given in Table M.2.

IFS m Include side m in the interface definition. Side m is defined for material n by the “B” command.

IFVA r<sub>c</sub> z<sub>c</sub> Plot the angular location of the interface based on the center point (r<sub>c</sub>,z<sub>c</sub>) along the abscissa. Positive angles are measured counterclockwise from the y-axis.

IFVS	Plot the distance along the interface from the first interface node along the abscissa (default).
LINE c n m <sub>1</sub> m <sub>2</sub> ...m <sub>n</sub>	Plot variation of component c along line defined with the “NLDF”, “PLDF”, “NSDF”, or the “NSSDF” commands given below. In determining variation, consider n materials including material number m <sub>1</sub> , m <sub>2</sub> ,...m <sub>n</sub> .
NCOL n	Number of colors in fringe plots is n. The default value for n is 6 which includes colors magenta, blue, cyan, green, yellow, and red. An alternative value for n is 5 which eliminates the minimum value magenta.
NLDF n n <sub>1</sub> n <sub>2</sub> ...n <sub>3</sub>	Define line for “LINE” command using n nodes including node numbers n <sub>1</sub> , n <sub>2</sub> ,...n <sub>n</sub> . This line moves with the nodes.
NSDF m	Define line for “LINE” command as side m. Side m is defined for material n by the “B” command.
NSSDF l m	Define line for “LINE” command and that includes boundary nodes l to m (counterclockwise) in the interface definitions. This command must follow the “B” command.
PLDF n r <sub>1</sub> z <sub>1</sub> ...r <sub>n</sub> z <sub>n</sub>	Define line for “LINE” command using n coordinate pairs (r <sub>1</sub> ,z <sub>1</sub> ), (r <sub>2</sub> ,z <sub>2</sub> ), ...(r <sub>n</sub> ,z <sub>n</sub> ). This line is fixed in space.
PRIN c n m <sub>1</sub> m <sub>2</sub> ...m <sub>n</sub>	Plot lines of principal stress and strain in the yz plane on n materials including materials m <sub>1</sub> , m <sub>2</sub> ,...,m <sub>n</sub> . If n is zero, only the outline of material m <sub>1</sub> is plotted. The lines are plotted in the principal stress and strain directions. Permissible component numbers in Table M.1 include 0, 5, 6, 100, 105, 106,...,etc. Orthogonal lines of both maximum and minimum stress are plotted if components 0, 100, 200, etc. are specified.
PROFILE c n m <sub>1</sub> m <sub>2</sub> ...m <sub>n</sub>	Plot component c versus element number for n materials including materials m <sub>1</sub> , m <sub>2</sub> ,...,m <sub>n</sub> . If n is 0 then component c is plotted for all elements. Component numbers are given in Table M.1.
VECTOR c n m <sub>1</sub> m <sub>2</sub> ...m <sub>n</sub>	Make a vector plot of component c on n materials including materials m <sub>1</sub> , m <sub>2</sub> ,...,m <sub>n</sub> . If n is zero, only the outline of material m <sub>1</sub> with vectors is plotted. Component c may be set to “D” and “V” for vector plots of displacement and velocity, respectively.

# APPENDIX M

No.	Component	No.	Component
1	y	21*	ln (V/Vo) (volumetric strain)
2	z	22*	y-displacement
3	hoop	23*	z-displacement
4	yz	24*	maximum displacement
5	maximum principal	25*	y-velocity, y-heat flux
6	minimum principal	26*	z-velocity, y-heat flux
7	von Mises (Appendix A)	27*	maximum velocity, maximum heat flux
8	pressure or average strain	28	ij normal
9	maximum principal-minimum principal	29	jk normal
10	y minus hoop	30	kl normal
11	maximum shear	31	li normal
12	ij and kl normal (Appendix D)	32	ij shear
13	jk and li normal	33	jk shear
14	ij and kl shear	34	kl shear
15	jk and li shear	35	li shear
16	y-deviatoric	36*	relative volume V/Vo
17	z-deviatoric	37*	VoV-1
18	hoop-deviatoric	38*	bulk viscosity, Q
19*	effective plastic strain	39*	P + Q
20*	temperature/internal energy density	40*	density
41*-70*	element history variables		
71*	r-peak acceleration	76*	peak value of min in plane prin. stress
72*	z-peak acceleration	77*	peak value of maximum hoop stress
73*	r-peak velocity	78*	peak value of minimum hoopstress
74*	z-peak velocity	79*	peak value of pressure
75*	peak value of max. in plane prin. stress		

**Table M.1.** Component numbers for element variables. By adding 100, 200 300, 400, 500 and 600 to the component numbers not followed by an asterisk, component numbers for infinitesimal strains, lagrange strains, almanshi strains, strain rates, extensions, and residual strain are obtained. Maximum and minimum principal stresses and strains are in the rz plane. The corresponding hoop quantities must be examined to determine the overall extremum. ij, jk, etc. normal components are normal to the ij, jk, etc side. The peak value database must be flagged on Control Card 4 in columns 6-10 or components 71-79 will not be available for plotting.

No.	Component
1	pressure
2	shear stress
3	normal force
4	tangential force
5	y-force
6	z-force

**Table M.2.** Component numbers for interface variables. In axisymmetric geometries the force is per radian.

---

**Cursor Commands**

---

DBD a b	Use cursor to define points a and b on boundary. Dekink boundary starting at a, moving counterclockwise, and ending at b.
DCN a b	Use cursor to define points a and b. The node closest to point a will be moved to point b.
DCSN n a	Move nodal point n to point a defined by the cursor.
DCNM a b	Use cursor to define points a and b. The node at point a is given the coordinate at point b.
DER a b	Use cursor to define points a and b on boundary. Equal space nodes in r-direction along boundary starting at a, moving counterclockwise, and ending at b.
DES a b	Use cursor to define points a and b on boundary. Equal space nodes along boundary starting at a, moving counterclockwise, and ending at b.
DEZ a b	Use cursor to define points a and b on boundary. Equal space nodes in z-direction along boundary starting at a, moving counterclockwise, and ending at b.
DTE a b	Use cursor to define points a and b on the diagonal of a window. The element numbers and coordinates of elements lying within the window are typed on the terminal.
DTN a b	Use cursor to define points a and b on the diagonal of a window. The node numbers and coordinates of nodal points lying within the window are typed on the terminal.
DTNC a	Use cursor to define point a. The nodal point number and nodal coordinates of the node lying closest to point a will be printed.

## APPENDIX M

---

DVS a b r	Use cursor to define points a and b on boundary. Variable space nodes along boundary starting at a, moving counterwise, and ending at b. The ratio of the first segment length to the last segment length is give by r (via terminal).
DZ a b	Use cursor to define points a and b on the diagonal of a window for zooming.
DZOUT a b	Enter two points with the cursor to define the window. The ratio of the current window with the specified window determines the picture size reduction.
DZZ a	Use cursor to define point a and zoom in at this point. The new window is .15 as large as the previous window. The zoom factor can be reset by the crzf command for the .15 default.
DZZO a	Zoom out at point a by enlarging the picture two times.



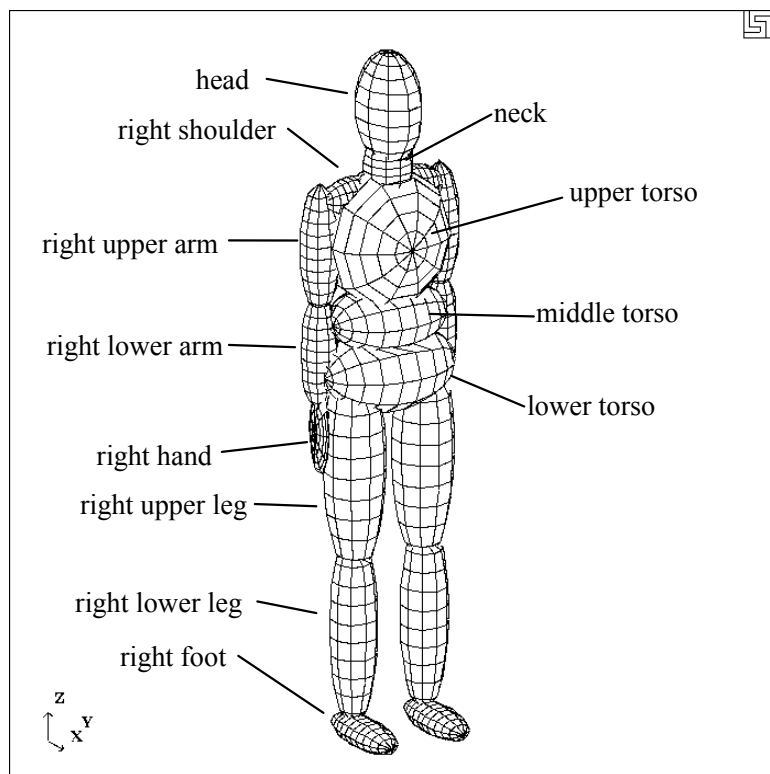
## APPENDIX N: Rigid Body Dummies

The two varieties of rigid body dummies available in LS-DYNA are described in this appendix. These are generated internally by including the appropriate \*COMPONENT keyword. A description of the GEBOD dummies begins on this page and the HYBRID III family on page N.7.

### GEBOD Dummies

Rigid body dummies can be generated and simulated within LS-DYNA using the keyword \*COMPONENT\_GEBOD. Physical properties of these dummies draw upon the GEBOD database [Cheng et al. 1994] which represents an extensive measurement program conducted by Wright-Patterson AFB and other agencies. The differential equations governing motion of the dummy are integrated within LS-DYNA separate from the finite element model. Interaction between the dummy and finite element structure is achieved using contact interfaces (see \*CONTACT\_GEBOD).

The dynamical system representing a dummy is comprised of fifteen rigid bodies (segments) and include: lower torso, middle torso, upper torso, neck, head, upper arms, forearms/hands, upper legs, lower legs, and feet. Ellipsoids are used for visualization and contact purposes. Shown in Figure N.1 is a 50th percentile male dummy generated using the keyword command \*COMPONENT\_GEBOD\_MALE. Note that the ellipsoids representing the shoulders are considered to be part of the upper torso segment and the hands are rigidly attached to the forearms.



**Figure N.1** 50th percentile male dummy in the nominal position.

## APPENDIX N

Each of the rigid segments which make up the dummy is connected to its neighbor with a joint which permits various relative motions of the segments. Listed in the Table N.1 are the joints and their applicable degrees of freedom.

Joint Name	Degree(s) of Freedom		
	1 <sup>st</sup>	2nd	3rd
pelvis	lateral flexion (x)	forward flexion (y)	torsion (z)
waist	lateral flexion (x)	forward flexion (y)	torsion (z)
lower neck	lateral flexion (x)	forward flexion (y)	torsion (z)
upper neck	lateral flexion (x)	forward flexion (y)	torsion (z)
shoulders	abduction-adduction (x)	internal-external rotation (z)	flexion-extension (y)
elbows	flexion-extension (y)	n/a	n/a
hips	abduction-adduction (x)	medial-lateral rotation (z)	flexion-extension (y)
knees	flexion-extension (y)	n/a	n/a
ankles	inversion-eversion (x)	dorsi-plantar flexion (y)	medial-lateral rotation (z)

**Table N.1** Joints and associated degrees of freedom. Local axes are in parentheses.

Orientation of a segment is effected by performing successive right-handed rotations of that segment relative to its parent segment - each rotation corresponds to a joint degree of freedom. These rotations are performed about the local segment axes and the sequence is given in Table N.1. For example, the left upper leg is connected to the lower torso by the left hip joint; the limb is first abducted relative to lower torso, it then undergoes lateral rotation, followed by extension. The remainder of the lower extremity (lower leg and foot) moves with the upper leg during this orientation process.

By default all joints are assigned stiffnesses, viscous characteristics, and stop angles which should give reasonable results in a crash simulation. One or all default values of a joint may be altered by applying the \*COMPONENT\_GEBOD\_JOINT\_OPTION command to the joint of interest. The default shape of the resistive torque load curve used by all joints is shown in Figure N.2. A scale factor is applied to this curve to obtain the proper stiffness relationship. Listed in Table N.2 are the default values of joint characteristics for dummies of all types and sizes. These values are given in the English system of units; the appropriate units are used if a different system is specified in card 1 of \*COMPONENT\_GEBOD\_OPTION.

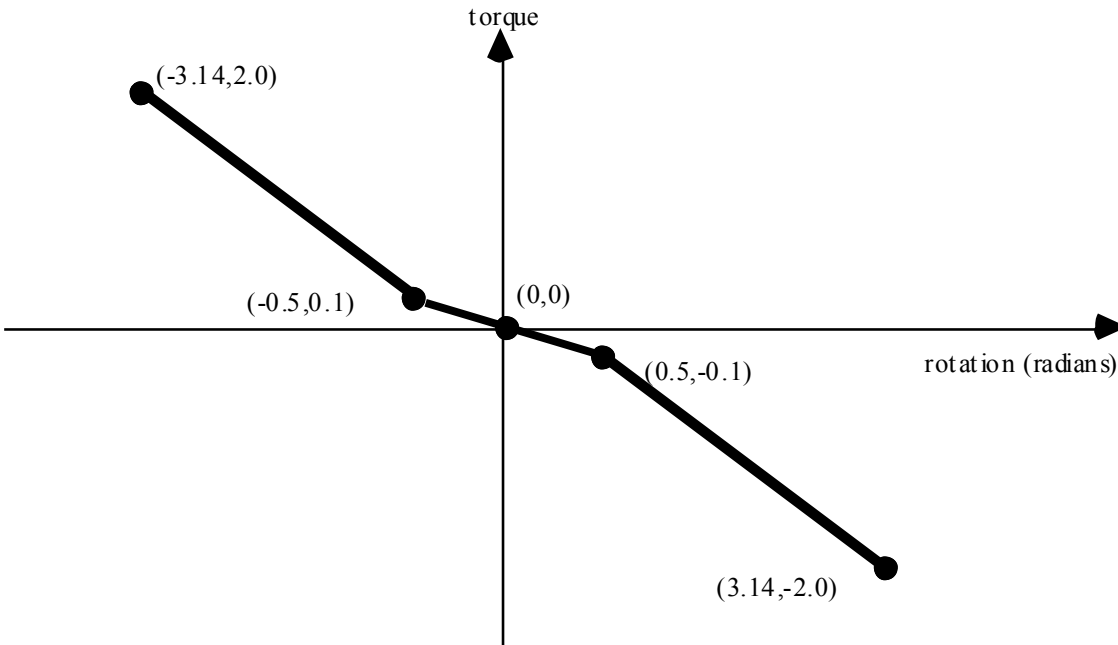
## APPENDIX N

joint degrees of freedom	load curve scale factor (in-lbf)	damping coef. (in-lbf-s/rad)	low stop angle (degrees)	high stop angle (degrees)	neutral angle (degrees)
pelvis - 1	65000	5.77	-20	20	0
pelvis - 2	65000	5.77	-20	20	0
pelvis - 3	65000	5.77	-5	5	0
waist - 1	65000	5.77	-20	20	0
waist - 2	65000	5.77	-20	20	0
waist - 3	65000	5.77	-35	35	0
lower neck - 1	10000	5.77	-25	25	0
lower neck - 2	10000	5.77	-25	25	0
lower neck - 3	10000	5.77	-35	35	0
upper neck - 1	10000	5.77	-25	25	0
upper neck - 2	10000	5.77	-25	25	0
upper neck - 3	10000	5.77	-35	35	0
l. shoulder - 1	100	5.77	-30	175	0
r. shoulder - 1	100	5.77	-175	30	0
shoulder - 2	100	5.77	-65	65	0
shoulder - 3	100	5.77	-175	60	0
elbow - 1	100	5.77	1	-140	0
l. hip - 1	10000	5.77	-25	70	0
r. hip - 1	10000	5.77	-70	25	0
hip - 2	10000	5.77	-70	70	0
hip - 3	10000	5.77	-140	40	0
knee - 1	100	5.77	-1	120	0
l. ankle - 1	100	5.77	-30	20	0
l. ankle - 1	100	5.77	-20	30	0
ankle - 2	100	5.77	-20	45	0
ankle - 3	100	5.77	-30	30	0

**Table N.2** Default joint characteristics for all dummies.

## APPENDIX N

---



**Figure N.2** Characteristic torque curve shape used by all joints.

The dummy depicted in Figure N.1 appears in what is referred to as its "nominal" position. In this position the dummy is standing upright facing in the positive x direction and the toe-to-head direction points in positive z. Additionally, the dummy's hands are at the sides with palms facing inward and the centroid of the lower torso is positioned at the origin of the global coordinate system. Each of the dummy's segments has a local coordinate system attached to it and in the nominal position all of the local axes are aligned with the global axes.

When performing a simulation involving a \*COMPONENT\_GEBOD dummy, a positioning file named "gebod.did" must reside in the directory with the LS-DYNA input file; here the extension did is the dummy ID number, see card 1 of \*COMPONENT\_GEBOD\_OPTION. The contents of a typical positioning file is shown in Table N.3; it consists of 40 lines formatted as (59a1,e30.0). All of the angular measures are input as degrees, while the lower torso global positions depend on the choice of units in card 1 of \*COMPONENT\_GEBOD\_OPTION. Setting all of the values in this file to zero yields the so-called "nominal" position.

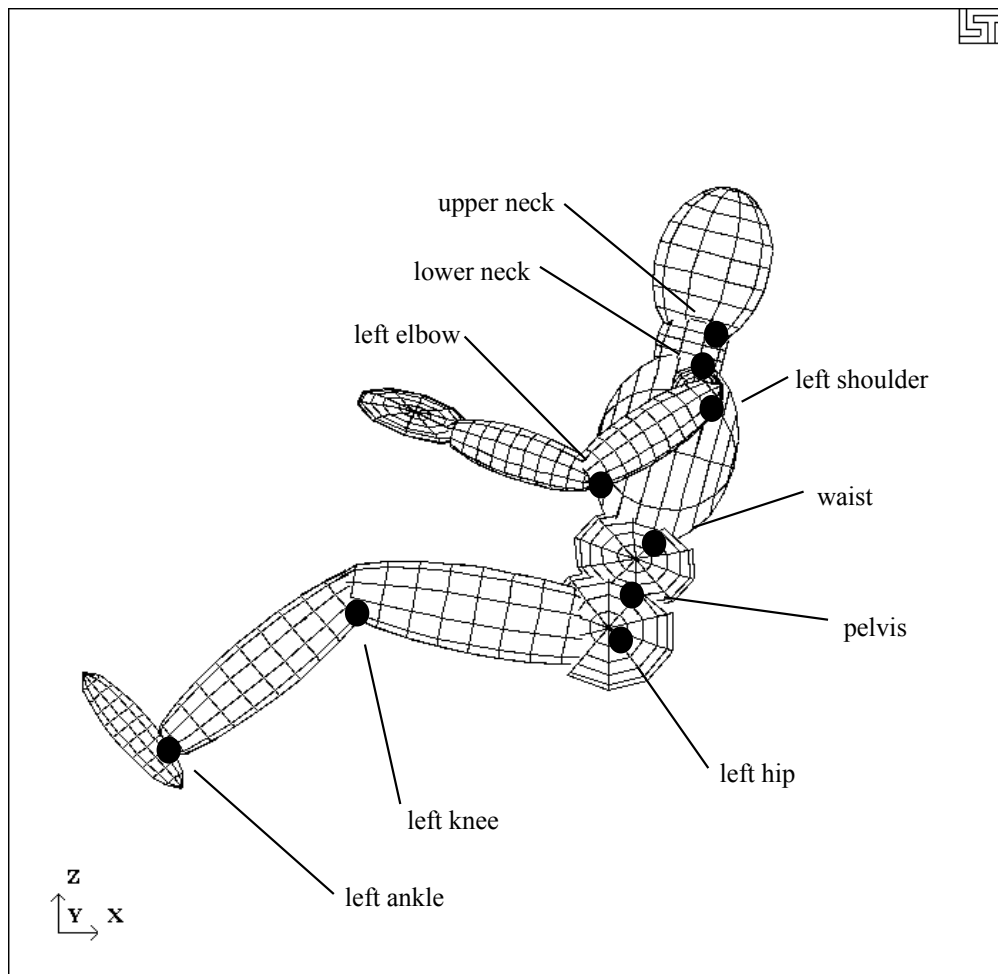
## APPENDIX N

lower torso	centroid global x position		0.0
lower torso	centroid global y position		0.0
lower torso	centroid global z position		0.0
total body	global x rotation		0.0
total body	global y rotation		-20.0
total body	global z rotation		180.0
pelvis	lateral flexion	+ = tilt right	0.0
pelvis	forward flexion	+ = lean fwd	0.0
pelvis	torsion	+ = twist left	0.0
waist	lateral flexion	+ = tilt right	0.0
waist	forward flexion	+ = lean fwd	0.0
waist	torsion	+ = twist left	0.0
lower neck	lateral flexion	+ = tilt right	0.0
lower neck	forward flexion	+ = nod fwd	0.0
lower neck	torsion	+ = twist left	0.0
upper neck	lateral flexion	+ = tilt right	0.0
upper neck	forward flexion	+ = nod fwd	0.0
upper neck	torsion	+ = twist left	0.0
left shoulder	abduction-adduction	+ = abduction	30.0
left shoulder	internal-external rotation	+ = external	-10.0
left shoulder	flexion-extension	- = fwd raise	-40.0
right shoulder	abduction-adduction	- = abduction	-30.0
right shoulder	internal-external rotation	- = external	10.0
right shoulder	flexion-extension	- = fwd raise	-40.0
left elbow	flexion-extension	+ = extension	-60.0
right elbow	flexion-extension	+ = extension	-60.0
left hip	abduction-adduction	+ = abduction	0.0
left hip	medial-lateral rotation	+ = lateral	0.0
left hip	flexion-extension	+ = extension	-80.0
right hip	abduction-adduction	- = abduction	0.0
right hip	medial-lateral rotation	- = lateral	0.0
right hip	flexion-extension	+ = extension	-80.0
left knee	flexion-extension	+ = flexion	50.0
right knee	flexion-extension	+ = flexion	50.0
left ankle	inversion-eversion	+ = eversion	0.0
left ankle	dorsi-plantar flexion	+ = plantar	0.0
left ankle	medial-lateral rotation	+ = lateral	0.0
right ankle	inversion-eversion	- = eversion	0.0
right ankle	dorsi-plantar flexion	+ = plantar	0.0
right ankle	medial-lateral rotation	- = lateral	0.0

# APPENDIX N

**Table N.3** Typical contents of a dummy positioning file.

In Figure N.3 the 50th percentile male dummy is shown in a seated position and some of its joints are labeled. The file listed in Table N.3 was used to put the dummy into the position shown. Note that the dummy was first brought into general orientation by setting nonzero values for two of the lower torso local rotations. This is accomplished by performing right-handed rotations successively about local axes fixed in the lower torso, the sequence of which follows: the first about local x, next about local y, and the last about local z. The dummy in Figure N.3 was made to pitch backward by setting "total body global y rotation" equal to -20. Setting the "total body global z rotation" equal to 180 caused the dummy to rotate about the global z-axis and face in the -x direction.



**Figure N.3** Dummy seated using the file listed in Table N.3.

**HYBRID III Dummies**

A listing of applicable joint degrees of freedom of the Hybrid III dummy is given below.

Joint Name	Degree(s) of Freedom		
	1 <sup>st</sup>	2nd	3rd
lumbar	flexion (y)	torsion (z)	
lower neck	flexion (y)	torsion (z)	
upper neck	flexion (y)	torsion (z)	
shoulders	flexion-extension (y)	abduction-adduction (x)	n/a
elbows	flexion-extension (y)	n/a	n/a
wrists	flexion-extension (x)	n/a	n/a
hips	abduction-adduction (x)	medial-lateral rotation (z)	flexion-extension (y)
knees	flexion-extension (y)	n/a	n/a
ankles	inversion-eversion (x)	medial-lateral rotation (z)	dorsi-plantar flexion (y)
sternum	translation (x)	rotation (y)	rotation (z)
knee sliders	translation (z)		

**Table N.4** Joints and associated degrees of freedom. Local axes are in parentheses.

Joint springs of the \*COMPONENT\_HYBRIDIII dummies are formulated in the following manner.

$$T = a_{lo}(q - q_{lo}) + b_{lo}(q - q_{lo})^3 \quad q \leq q_{lo}$$

$$T = a_{hi}(q - q_{hi}) + b_{hi}(q - q_{hi})^3 \quad q \geq q_{hi}$$

$$T = 0 \quad q_{lo} < q < q_{hi}$$

where

T is the joint torque

q is the joint generalized coordinate

$a_{lo}$  and  $b_{lo}$  are the linear and cubic coefficients, respectively, for the low regime

$a_{hi}$  and  $b_{hi}$  are the linear and cubic coefficients, respectively, for the high regime

$q_{lo}$  and  $q_{hi}$  are the activation values for the low and high regimes, respectively





## APPENDIX O: LS-DYNA MPP User Guide

This is a short user's guide for the MPP version of LS-DYNA. For a general guide to the capabilities of LS-DYNA and a detailed description of the input, consult the LS-DYNA User's Manual. If you have questions about this guide, find errors or omissions in it, please email [manual@lstc.com](mailto:manual@lstc.com).

### Supported Features

The only input formats currently supported are 920 and later, including keyword. Models in any of the older formats will need to be converted to one of these input formats before they can be run with the current version of LS-DYNA for massively parallel processors, mpp.

The large majority of LS-DYNA options are available on MPP computers. Those that are not supported are being systematically added. Unless otherwise noted here, all the options of LS-DYNA version 93x are supported by MPP/LS-DYNA.

Here is the list of **unsupported** features:

- \*BOUNDARY\_THERMAL\_WELD
- \*BOUNDARY\_USA\_SURFACE
- \*CONTACT\_1D
- \*DATABASE\_AVS
- \*DATABASE\_MOVIE
- \*DATABASE\_MPGS
- \*DATABASE\_TRACER
- \*DATABASE\_BINARY\_XTFILE
- \*INTERFACE\_JOY
- \*LOAD\_SUPERPLASTIC\_OPTION
- \*USER
- \*TERMINATION\_NODE

### Contact Interfaces

MPP/LS-DYNA uses a completely redesigned, highly parallel contact algorithm. The contact options currently **unsupported** include:

- \*CONTACT\_FORCE\_TRANSDUCER\_CONSTRAINT

Because these options are all supported via the new, parallel contact algorithms, slight differences in results may be observed as compared to the serial and SMP versions of LS-DYNA. Work has been done to minimize these differences, but they may still be evident in some models.

For each of the supported CONTACT\_ control cards, there is an optional string \_MPP which can be appended to the end. Adding these characters triggers the reading of a new control card immediately following (but after the TITLE card, if any). See the section on \*CONTACT for details of the parameters and their meanings.

# APPENDIX O

---

## Output Files and Post-Processing

For performance reasons, many of the ASCII output files normally created by LS-DYNA have been combined into a new binary format used by MPP/LS-DYNA. There is a post-processing program l2a, which reads this binary database of files and produces as output the corresponding ASCII files. The new binary files will be created in the directory specified as the global directory in the pfile (See section pfile). The files (up to one per processor) are named binoutnnnn, where nnnn is replaced by the four-digit processor number. To convert these files to ASCII simply feed them to the l2a program like this:

### **l2a binout\***

LS-PREPOST is able to read the binout files directly, so conversion is not required, it is provided for backward compatibility.

The **supported** ASCII files are:

- \*DATABASE\_SECFORC
- \*DATABASE\_RWFORC
- \*DATABASE\_NODOUT
- \*DATABASE\_NODOUTHF
- \*DATABASE\_ELOUT
- \*DATABASE\_GLSTAT
- \*DATABASE\_DEFORC
- \*DATABASE\_MATSUM
- \*DATABASE\_NCFORC
- \*DATABASE\_RCFORC
- \*DATABASE\_SPCFORC
- \*DATABASE\_SWFORC
- \*DATABASE\_DEFGEO
- \*DATABASE\_ABSTAT
- \*DATABASE\_NODOFR
- \*DATABASE\_BNDOUT
- \*DATABASE\_GCEOUT
- \*DATABASE\_RBDOUT
- \*DATABASE\_SLEOUT
- \*DATAGASE\_JNTFORC
- \*DATABASE\_SBTOUT
- \*DATABASE\_SPHOUT
- \*DATABASE\_TPRINT

Some of the normal LS-DYNA files will have corresponding collections of files produced by MPP/LS-DYNA, with one per processor. These include the d3dump files (new names = d3dump.nnnn), the messag files (now mesnnnn) and others. Most of these will be found in the local directory specified in the pfile.

The format of the d3plot file has not been changed. It will be created in the global directory, and can be directly handled with your current graphics post-processor.

## Parallel Specific Options

There are a few new command line options that are specific to the MPP version of LS-DYNA.

In the serial and SMP versions of LS-DYNA, the amount of memory required to run the problem can be specified on the command line using the keyword `memory=XXX`, where `XXX` is the number of words of memory to be allocated. For the MPP code, this will result in each processor allocating `XXX` words of memory. If pre-decomposition has not been performed, one processor must perform the decomposition of the problem. This can require substantially more memory than will be required once execution has started. For this reason, there is a second memory command line option, `memory2=YYY`. If used together with the `memory` keyword, the decomposing processor will allocate `XXX` words of memory, and all other processors will allocate `YYY` words of memory.

For example, in order to run a 250,000 element crash problem on 4 processors, you might need `memory=80m` and `memory2=20m`. To run the same problem on 16 processors, you still need `memory=80m`, but can set `memory2=6m`. The value for `memory2` drops nearly linearly with the number of processors used to run the program, which works well for shared-memory systems.

Execution of the implicit solver in MPP requires a balance of memory across all of the processes. The user should not use `memory2=` specification for runs involving the implicit solver. If the model decomposition cannot be performed for the given `memory=` specification, one can try a pre-decomposition but the user would be advised to use a compute cluster with more real memory. It is suggested that the `memory=` specification be such to use no more than 75% of the real memory available to that process. On a compute cluster with each compute node having 48 Gbytes of memory and using 8 MPI processes, there is only 6 Gbytes of real memory per process. Converting to 8 byte words and using only the suggested 75% would have `memory=560M` as the maximum specification.

The full deck restart capability is supported by the MPP version of LS-DYNA, but in a manner slightly different than the SMP code. Each time a restart dump file is written, a separate restart file is also written with the base name `D3FULL`. For example, when the third restart file `d3dump03` is written (one for each processor, `d3dump03.0000`, `d3dump03.0001`, etc), there is also a single file written named `d3full03`. This file is required in order to do a full deck restart and the `d3dump` files are not used in this case by the MPP code. In order to perform a full deck restart with the MPP code, you first must prepare a full deck restart input file as for the serial/SMP version. Then, instead of giving the command line option `r=d3dump03` you would use the special option `n=d3full03`. The presence of this command line option tells the MPP code that this is a restart, not a new problem, and that the file `d3full03` contains the geometry and stress data carried over from the previous run.

## PFILE

There is a new command line option: `p=pfile`. `pfile` contains MPP specific parameters that affect the execution of the program. The file is split into sections, with several options in each section. Currently, these sections: **directory**, **decomposition**, **contact**, and **general** are available. First, here is a sample `pfile`:

```
directory {
```

## APPENDIX O

---

```
global rundir
local /tmp/rundir
}
contact {
inititer 3
}
```

The file is case insensitive and free format input. The sections and options currently supported are:

- **directory.** Holds directory specific options

### **transfer\_files**

If this keyword is given, then processor 0 will write all output and restart files to the **global** directory (see “global” below), and scratch files to the **local** directory. All other processors will write all data to their **local** directory. At normal termination, all restart and output files will be copied from the processor specific **local** directories to the **global** directory. Also, if this is a restart from a dump file, the dump files will be distributed to the processors from the **global** directory. With this option enabled, there is no need for the processors to have shared access to a single disk for output – all files will be transferred as needed to and from the **global** directory.

**Default = disabled.**

### **global path**

Path to a directory where program output should be written. If **transfer\_files** is not given, this directory needs to be accessible to all processors – otherwise it is only accessed by processor 0. This directory will be created if necessary.

**Default = current working directory**

### **global\_message\_files**

If this keyword appears, the message files are written in the global directory rather than the local directory

**Default = disabled (message files go in the local directory)**

### **local path**

Path to a processor specific local directory for scratch files. This directory will be created if necessary. This should be a local disk on each processor, for performance reasons.

**Default = global path**

### **rmlocal**

If this keyword is given and **transfer\_files** is active, the program attempts to clean up the **local** directories on each processor. In particular, it deletes files that are successfully transferred back to the **global** directory, and removes the **local** directory if it was created. It will not delete any files if there is a failure during file copying, nor will it delete directories it did not create.

**Default = disabled**

## repository path

Path to a safe directory accessible from processor 0. This directory will be created if necessary. This is intended to be used as a safekeeping/backup of files during execution and should only be used if **transfer\_files** is also given. If this directory is specified then the following actions occur:

- At program start up, any required files (d3dump, binout, etc) that cannot be located in the **global** directory are looked for in the **repository** for copying to the **local** processor directories.
- Important output files (d3dump, runrsf, d3plot, binout and others) are synchronized to the repository regularly. That is, every time one of these files is updated on the node local or the global directories, a synchronized copy is updated in the repository.

The intention is that the repository be on a redundant disk, such as NAS, to allow restarting the problem if a hardware failure should occur on the machine running the problem. It must be noted that some performance penalty must be paid for the extra communication and I/O. Effort has been made to minimize this overhead, but this option is not recommended for general use.

**Default = unspecified**

- **decomposition** Holds decomposition specific options

## file filename

The name of the file that holds the decomposition information. This file will be created in the current working directory if it does not exist. If this option is not specified, MPP/LS-DYNA will perform the decomposition.

**Default = None**

## numproc n

The problem will be decomposed for n processors. If  $n > 1$  and you are running on 1 processor, or if the number of processors you are running on does not evenly divide n, then execution terminates immediately after decomposition. Otherwise, the decomposition file is written and execution continues. For a decomposition only run, both **numproc** and **file** should be specified.

**Default = the number of processors you are running on.**

## method name

Currently, there are two decomposition methods supported, namely rcb and greedy. Method rcb is Recursive Coordinate Bisection. Method greedy is a simple neighborhood expansion algorithm. The impact on overall runtime is problem dependent, but rcb generally gives the best performance.

**Default = rcb**

## region rx ry rz sx sy sz c2r s2r 3vec mat

See the section below on Special Decompositions for details about these decomposition options.

## APPENDIX O

---

### **show**

If this keyword appears in the decomposition section, the d3plot file is doctored so that the decomposition can be viewed with the post processor. Displaying material 1 will show that portion of the problem assigned to processor 0, and so on. The problem will not actually be run, but the code will terminate once the initial d3plot state has been written.

### **rcblog filename**

This option is ignored unless the decomposition method is RCB. A record is written to the indicated file recording the steps taken during decomposition. This is an ascii file giving each decomposition **region** (see the section on Special Decompositions) and the location of each subdivision for that **region**. Except for the addition of this decomposition information, the file is otherwise equivalent to the current pfile. Thus it can be used directly as the pfile for a subsequent problem, which will result in a decomposition as similar as possible between the two runs. For example, suppose a simulation is run twice, but the second time with a slightly different mesh. Because of the different meshes the problems will be distributed differently between the processors, resulting in slightly different answers due to roundoff errors. If an rcblog is used, then the resulting decompositions would be as similar as possible.

### **vspeed**

If this option is specified a brief measurement is taken of the performance of each processor by timing a short floating point calculation. The resulting information is used during the decomposition to distribute the problem according to the relative speed of the processors. This might be of some use if the cluster has machines of significantly different speed.

### **automatic**

If this option is given, an attempt is made to automatically determine a reasonable decomposition, primarily based on the initial velocity of nodes in the model. Use of the **show** option is recommended to verify a reasonable decomposition.

### **aledist**

Distribute ALE elements to all processors.

### **dcmem n**

It may be in some cases that the memory requirements during the first phase of decomposition are too high. If that is found to be the case (if you get out of memory errors during decomposition phase 1), then this may provide a work around. Specifying a value **n** here will cause some routines to process the model in blocks of **n** items, when normal processing would read the whole set (of nodes, elements, whatever) all at once. This will reduce memory requirements at the cost of greater communication overhead. Most users will not need this option. Values in the range of 10,000 to 50,000 would be reasonable.

- **contact**

This section has been largely replaced by the `_MPP` option on the normal contact card. The only remaining useful option here is:

**alebkt n**

Sets the bucket sort frequency for FSI (fluid structure interaction) to once every **n** cycles.  
**default = 50**

- **general**      Holds general options

**nodump**

If this keyword appears, all restart dump file writing will be suppressed: `d3dump`, `runrsf`, and `d3full` files will not be written.

**nofull**

If this keyword appears, writing of `d3full` (full deck restart) files will be suppressed.

**nod3dump**

If this keyword appears, writing of `d3dump` and `runrsf` files will be suppressed.

**runrsfonly**

If this keyword appears, writing of `d3dump` files will not occur – `runrsf` files will be written instead. Any time a `d3dump` OR `runrsf` file would normally be written, a `runrsf` file will be written.

**nofail**

If this keyword appears, the check for failed elements in the contact routines will be skipped. This can improve efficiency if you do not have element failure in the model.

**swapbytes**

If this keyword appears, the `d3plot` and interface component analysis files are written in swapped byte ordering.

**nobeamout**

Generally, whenever a beam, shell, or solid element fails, and element failure report is written to the `d3hsp` and message files. This can generate a lot of output. If this keyword appears, the element failure report is suppressed.

## Special Decompositions

These options appear in the "decomposition" section of the `pfile` and are only valid if the decomposition method is **rcb**. The `rcb` decomposition method works by recursively dividing the model in half, each time slicing the current piece of the model perpendicularly to one of the three coordinate axes. It chooses the axis along which the current piece of the model is longest. The result is that it tends to generate cube shaped domains aligned along the coordinate axes. This is inherent in the algorithm, but is often not the behavior desired.

## APPENDIX O

---

This situation is addressed by providing a set of coordinate transformation functions which are applied to the model before it is decomposed. The resulting deformed geometry is then passed to the decomposition algorithm, and the resulting domains are mapped back to the undeformed model. As a simple example, suppose you wanted rectangular domains aligned along a line in the xy plane, 30 degrees from the x axis, and twice as long along this line as in the other two dimensions. If you applied these transformations:

```
sx 0.5
rz -30
```

then you would achieve the desired effect.

Furthermore, it may be desirable for different portions of the model to be decomposed differently. It is now possible to specify different regions of the model to be decomposed with different transformations. The general form for a special decomposition would look like this:

```
decomposition {
  region { <region specifiers> <transformation> <grouping> }
  region { <region specifiers> <transformation> <grouping> }
  <transformation>
}
```

Where the region specifiers are logical combinations of **box**, **sphere**, **cylinder**, **parts**, and **silist**. The transformation is a series of **sx**, **sy**, **sz**, **rx**, **ry**, **rz**, **c2r**, **s2r**, **3vec**, and **mat**. The grouping is either **lumped** or empty. The portion of the model falling in the first region will be decomposed according to the given transformation. Any remaining part of the model in the second region will then be treated, and finally anything left over will be decomposed according to the final transformation. Any number of regions may be given, including 0. Any number of transformations may be specified. They are applied to the region in the order given.

The region specifiers are:

**box xmin xmax ymin ymax zmin zmax**

A box with the given extents.

**sphere xc yc zc r**

The sphere centered at **(xc,yc,zc)** and having radius **r**. If **r** is negative it is treated as infinite.

**cylinder xc yc zc ax ay az r d**

A cylinder with center at **(xc,yc,zc)** and radius **r**, extending out in the direction of **(ax,ay,az)** for a distance of **d**. If **d** is 0, the cylinder is infinite in both directions.

**parts n1 n2 n3 n4....**

All parts whose user id matches one of the given values are included in the region. Any number of values may be given.



**silist n1 n2 n3 n4....**

All elements involved in a contact interface whose user id matches one of the given values are included in the region.

The transformations available are:

**sx t**

scale the current x coordinates by t.

**sy t**

scale the current y coordinates by t.

**sz t**

scale the current z coordinates by t.

**rx t**

rotate around the current x axis by t degrees.

**ry t**

rotate around the current y axis by t degrees.

**rz t**

rotate around the current z axis by t degrees.

**mat m11 m12 m13 m21 m22 m23 m31 m32 m33**

transform the coordinates by matrix multiplication:

	transformed		original
x	=	m11 m12 m13	x
y	=	m21 m22 m23	y
z	=	m31 m32 m33	z

**3vec v11 v12 v13 v21 v22 v23 v31 v32 v33**

Transform the coordinates by the inverse of the transpose matrix:

	original		transformed
x	=	v11 v21 v31	x
y	=	v12 v22 v32	y
z	=	v13 v23 v33	z

This appears complicated, but in practice is very intuitive: instead of decomposing into cubes aligned along the coordinate axes, rcb will decompose into parallelipipeds whose edges are aligned with the three vectors (v11, v12, v13), (v21, v22, v23), and (v31, v32, v33). Furthermore, the relative lengths of the edges of the decomposition domains will correspond to the relative lengths of these vectors.

**C2R x0 y0 z0 vx1 vy1 vz1 vx2 vy2 vz2**

The part is converted into a cylindrical coordinate system with origin at (x0, y0, z0), cylinder axis (vx1, vy1, vz1) and theta=0 along the vector (vx2, vy2, vz2). You can think

## APPENDIX O

---

of this as tearing the model along the (vx2, vy2, vz2) vector and unwrapping it around the (vx1, vy1, vz1) axis. The effect is to create decomposition domains that are "cubes" in cylindrical coordinates: they are portions of cylindrical shells. The actual transformation is:

new (x,y,z) = cylindrical coordinates (r,theta,z)

Knowing the order of the coordinates is important if combining transformations, as in the example below.

### **S2R x0 y0 z0 vx1 vy1 vz1 vx2 vy2 vz2**

Just like the above, but for spherical coordinates. The (vx1,vy1,vz1) vector is the phi=0 axis.

New (x,y,z) = spherical coordinates (rho, theta, phi)

The grouping qualifier is:

### **lumped**

Group all elements in the region on a single processor. If this qualifier is not given, the elements in the region are distributed across all processors.

### **Examples:**

rz 45

will generate domains rotated -45 degrees around the z axis.

C2R 0 0 0 0 0 1 1 0 0

will generate cylindrical shells of domains. They will have their axis along the vector (0,0,1), and will start at the vector (1,0,0) Note that the part will be cut at (1,0,0), so no domains will cross this boundary. If there is a natural boundary or opening in your part, the "theta=0" vector should point through this opening. Note also that if the part is, say, a cylinder 100 units tall and 50 units in radius, after the C2R transformation the part will fit inside the box  $x=[0,50]$ ,  $y=[0, 2\text{PI}]$ ,  $z=[0,100]$ . In particular, the new y coordinates (theta) will be very small compared to the other coordinate directions. It is therefore likely that every decomposition domain will extend through the complete transformed y direction. This means that each domain will be a shell completely around the original cylinder. If you want to split the domains along radial lines, try this pair of transformations:

C2R 0 0 0 0 0 1 1 0 0

SY 5000

This will do the above C2R, but then scale y by 5000. This will result in the part appearing to be about 30,000 long in the y direction -- long enough that every decomposition domain will divide the part in this (transformed) y direction. The result will be decomposition domains that are radial "wedges" in the original part.

General combinations of transformations can be specified, and they are applied in order:

```
SX 5 SY .2 RZ 30
    will scale x, then y, then rotate.
```

A more general decomposition might look like:

```
decomposition { rx 45 sz 10
region { parts 1 2 3 4 5 and sphere 0 0 0 200 lumped }
region { box 0 100 -1.e+8 1.e+8 0 500 or sphere 100 0 200 200 rx 20 }
}
```

This would take elements that have user ID 1, 2, 3, 4, or 5 for their part, AND that lie in the sphere of radius 200 centered at (0,0,0), and place them all on one processor.

Then, any remaining elements that lie in the given box OR the sphere of radius 200 centered at (100,0,200) would be rotated 20 degrees in x then decomposed across all processors. Finally, anything remaining would be rotated 45 degrees in x, scaled 10 in z, and distributed to all processors. In general, region qualifiers can be combined using the logical operations **and**, **or**, and **not**. Grouping using parentheses is also supported.

### Execution of MPP/LS-DYNA

MPP/LS-DYNA runs under a parallel environment which provided by the hardware vendor. The execution of the program therefore varies from machine to machine. On some platforms, command line parameters can be passed directly on the command line. For others, the use of the names file is required. The names file is supported on all systems.

The serial/SMP code supports the use of the SIGINT signal (usually Ctrl-C) to interrupt the execution and prompt for user input, generally referred to as "sense switches." The MPP code also supports this capability. However, on many systems a shell script or front end program (generally "mpirun") is required to start MPI applications. Pressing Ctrl-C on some systems will kill this process, and thus kill the running MPP-DYNA executable. As a workaround, when the MPP code begins execution it creates a file "bg\_switch" in the current working directory. This file contains the following single line:

```
rsh <machine name> kill -INT <PID>
```

where <machine name> is the hostname of the machine on which the root MPP-DYNA process is running, and <PID> is its process id. (on HP systems, "rsh" is replaced by "remsh"). Thus, simply executing this file will send the appropriate signal.

Here is a simple table to show how to run the program on various platforms. Of course, scripts are often written to mask these differences.

## APPENDIX O

---

Platform	Execution Command
DEC Alpha	dmpirun -np n mpp-dyna
Fujitsu	jobexec -vp n -mem m mpp-dyna
Hitachi	mpirun -np n mpp-dyna
HP	mpp-dyna -np n
IBM	#!/bin./ksh export MP_PROC=n export MP_LABELIO=no export MP_EUILIB=us export MPI_EUIDEVICE=cSS0 poe mpp-dyna
NEC	mpirun -np n mpp-dyna
SGI	mpirun -np n mpp-dyna
Sun	tmrn -np n mpp-dyna

Where **n** is the number of processors, **mpp-dyna** is the name of the MPP/LS-DYNA executable, and **m** is the MB of real memory.

---

**APPENDIX P: Implicit Solver**

---

**INTRODUCTION**

The terms implicit and explicit refer to time integration algorithms. In the explicit approach, internal and external forces are summed at each node point, and a nodal acceleration is computed by dividing by nodal mass. The solution is advanced by integrating this acceleration in time. The maximum time step size is limited by the Courant condition, producing an algorithm which typically requires many relatively inexpensive time steps.

While explicit analysis is well suited to dynamic simulations such as impact and crash, it can become prohibitively expensive to conduct long duration or static analyses. Static problems such as sheet metal springback after forming are one application area for implicit methods.

In the implicit method, a global stiffness matrix is computed, inverted, and applied to the nodal out-of-balance force to obtain a displacement increment. The advantage of this approach is that time step size may be selected by the user. The disadvantage is the large numerical effort required to form, store, and factorize the stiffness matrix. Implicit simulations therefore typically involve a relatively small number of expensive time steps.

The implicit analysis capability was first released in Version 950. Initially targeted at metal forming springback simulation, this new capability allowed static stress analysis. Version 970 adds many additional implicit features, including new element formulations for linear and modal analysis.

For best implicit performance, it is important to provide enough memory to allow the stiffness matrix factorization to run in-core. In most cases, the default memory size must be increased. See the Linear Equation Solver section below.

**SETTING UP AN IMPLICIT SIMULATION**

The keyword `*CONTROL_IMPLICIT_GENERAL` is used to activate the implicit method. LS-DYNA can conduct either a linear or a nonlinear implicit analysis. The keyword `*CONTROL_IMPLICIT_SOLUTION` is used to select between these implicit analysis types. In addition, an implicit eigenvalue analysis can be performed to extract frequencies and mode shapes.

To perform a linear implicit analysis, use the `*CONTROL_IMPLICIT_GENERAL` keyword to activate the implicit method and to specify the time step size. Enter the termination time using the `*CONTROL_TERMINATION` keyword. For a single step analysis, select the step size to be equal to the termination time. Use the `*CONTROL_IMPLICIT_SOLUTION` keyword to request a linear analysis. Select linear element formulations using the `*SECTION_SOLID` and/or `*SECTION_SHELL` keywords. For best accuracy, a double precision version of LS-DYNA should be used for linear analysis.

## APPENDIX P

---

To perform an eigenvalue analysis, use the `*CONTROL_IMPLICIT_GENERAL` keyword to activate the implicit method and to specify a time step size. Enter the termination time using the `*CONTROL_TERMINATION` keyword (the time step size and termination time must be nonzero, but will otherwise be ignored as LS-DYNA will presently just compute the eigenvalues and stop.) Use the `*CONTROL_IMPLICIT_EIGENVALUE` keyword to indicate the desired number of eigenvalues and frequency ranges of interest. For best accuracy, a double precision version of LS-DYNA should be used for eigenvalue analysis.

A nonlinear implicit simulation is typically divided into several steps. In a dynamic simulation, these are time steps. In a static simulation, these are load steps. Multiple steps may be used to divide the nonlinear behavior into manageable pieces, to obtain results at intermediate stages during the simulation, or perhaps to resolve a particular frequency of motion in dynamic simulations. In each step, an equilibrium geometry is sought which balances internal and external forces in the model. The nonlinear equation solver performs an iterative search using one of several Newton based methods. Convergence of this iterative process is obtained when norms of displacement and/or energy fall below user-prescribed tolerances.

Control parameters for the nonlinear equation solver are input using the keyword `*CONTROL_IMPLICIT_SOLUTION`. By default, the progress of the equilibrium search is not shown to the screen. This output can be activated either using the `NLPRINT` input parameter, or interactively toggled on and off by entering “<ctrl-c> nlprint”. The box below shows a typical iteration sequence, where the norms of displacement ( $du/u$ ) and energy ( $E_i/E_0$ ) are displayed. When these norms are reduced below user prescribed tolerances (default  $1.0e-3$  and  $1.0e-2$ , respectively), equilibrium is reached within sufficient accuracy, the iteration process is said to have converged, and the solution proceeds to the next time step.

```
BEGIN time step      3
=====
                time =  1.50000E-01
    current step size =  5.00000E-02
Iteration:  1      *|du|/|u| =  3.4483847E-01      *Ei/E0 =  1.0000000E+00
Iteration:  2      *|du|/|u| =  1.7706435E-01      *Ei/E0 =  2.9395439E-01
Iteration:  3      *|du|/|u| =  1.6631174E-03      *Ei/E0 =  3.7030904E-02
Iteration:  4      *|du|/|u| =  9.7088516E-05      *Ei/E0 =  9.6749731E-08
```

A typical print-out showing the progress of the nonlinear equation solver. By default, the progress of the equilibrium search is not shown to the screen. This output can be activated either using the `NLPRINT` input parameter, or interactively toggled on and off by entering: “<ctrl-c> nlprint”.

### LINEAR EQUATION SOLVER

Within each equilibrium iteration, a linear system of equations of the form  $\mathbf{K}_{\Delta}\mathbf{u} = \mathbf{R}$  must be solved. To do this, the stiffness matrix  $\mathbf{K}$  is inverted and applied to the out-of-balance load or residual  $\mathbf{R}$ , yielding a displacement increment  $\Delta\mathbf{u}$ . Storing and solving this linear system represents a large portion of the memory and CPU costs of an implicit analysis.

Control parameters for solving the linear system  $\mathbf{K}_{\Delta}\mathbf{u} = \mathbf{R}$  are input using the keyword `*CONTROL_IMPLICIT_SOLVER`. Several different linear equation solvers are available,

including direct (Gaussian elimination) and iterative (conjugate gradient, Lanczos) methods. A sparse storage scheme is used to minimize memory requirements, which are still often substantial. Two options are available for matrix reordering, allowing nodes and elements to be numbered arbitrarily by the user.

It is very important to allow enough memory for the stiffness matrix factorization to run incore. Although the direct solvers can run out-of-core, using disk files for scratch space, this can slow performance by 100x or more. To view memory requirements for a particular model, select LPRINT=1 on \*CONTROL\_IMPLICIT\_SOLVER, or interactively type “<ctrl-c> lprint”. Summary information will be printed to the screen and messag files. Use the command line option “memory=...” to increase memory until this summary reports that the TOTAL AVAILABLE memory is large enough that the solver runs “INCORE”. The memory size may also be specified on \*KEYWORD.

## NONLINEAR EQUATION SOLVER

Several different nonlinear equation solvers are available for finding equilibrium within each step. All are iterative in nature. In the full Newton method, a new stiffness matrix is formed and inverted each equilibrium iteration. This is the most costly method, but can require fewer iterations to reach equilibrium. In the modified Newton method, several iterations are performed using the same stiffness matrix. After each iteration, the geometry is updated using  $\Delta \mathbf{u}$  and a new  $\mathbf{R}$  is computed. This approach reduces cost by avoiding some forming and factoring of the stiffness matrix  $\mathbf{K}$ , but usually requires more iterations to reach equilibrium.

The default nonlinear equation solver is the BFGS solver, which uses a quasi-Newton method. In this method, the inverted stiffness matrix  $\mathbf{K}$  is used for several iterations, but is improved after each iteration using an inexpensive rank two update. If convergence is not reached after 10 iterations, or if divergence (increasing  $\mathbf{R}$ ) is detected, then a new stiffness matrix is automatically formed and inverted. This hybrid method combines the efficiency of the modified Newton method with the reliability of the full Newton method. The number of iterations between stiffness matrix reformations is a user input, defaulting to 10. If a value of one is chosen, then the full Newton method is recovered.

```

      BEGIN time step      1
      =====
                time =  1.00000E+00
      current step size =  1.00000E+00

Iteration:   1      *|du|/|u| =  2.5517753E+00      *Ei/E0 =  1.0000000E+00

DIVERGENCE (increasing residual norm) detected:
      |{Fe}-{Fi}| ( 7.5426269E+03) exceeds |{Fe}| ( 5.0000000E+00)
      automatically REFORMING stiffness matrix...

Iteration:   2      *|du|/|u| =  6.0812935E-01      *Ei/E0 =  4.0526413E-01
Iteration:   4      *|du|/|u| =  1.0974191E-02      *Ei/E0 =  2.3907781E-04
Iteration:   5      *|du|/|u| =  1.0978787E-02      *Ei/E0 =  1.7910795E-04
Iteration:   6      *|du|/|u| =  4.2201181E-03      *Ei/E0 =  4.2557768E-05

```

## APPENDIX P

---

```
Iteration: 7      *|du|/|u| = 4.1142219E-03      *Ei/E0 = 3.0658711E-05
Iteration: 8      *|du|/|u| = 1.9794757E-03      *Ei/E0 = 9.1215551E-06
Iteration: 9      *|du|/|u| = 1.7957653E-03      *Ei/E0 = 6.1669480E-06
Iteration: 10     *|du|/|u| = 1.2022830E-03      *Ei/E0 = 2.9031284E-06
```

```
ITERATION LIMIT reached, automatically REFORMING stiffness matrix...
```

```
Iteration: 11     *|du|/|u| = 5.4011414E-04      *Ei/E0 = 1.0553019E-06
```

The print-out above shows typical behavior of the default BFGS nonlinear equation solver. Two automatic stiffness reformations are performed, initially due to divergence, and later when the default limit of 10 iterations is exceeded. By default, the progress of the equilibrium search is not shown to the screen. This output can be activated either using the NLPRINT input parameter, or interactively toggled on and off by entering “<ctrl-c> nlprint”.

$$\mathbf{K}_{n+1}^{-1} = (\mathbf{I} + \mathbf{w}\mathbf{v}^T) \mathbf{K}_n^{-1} (\mathbf{I} + \mathbf{v}\mathbf{w}^T)$$

The BFGS update: A new stiffness matrix inverse is approximated by the old stiffness matrix inverse, and the outer product of two carefully chosen vectors.

### ELEMENT FORMULATIONS FOR IMPLICIT ANALYSIS

The default element formulations in LS-DYNA are highly efficient, using single point integration. For implicit analysis it is generally more effective to use more expensive element formulations which are less susceptible to hourglass instability. The Hughes-Liu brick element #2 and shell element #6, and the fast shell #16 are good choices for implicit analysis. Stiffness forms of hourglass control are recommended, with hourglass type #6 required for use with implicit solid elements.

### APPLYING LOADS DURING IMPLICIT ANALYSIS

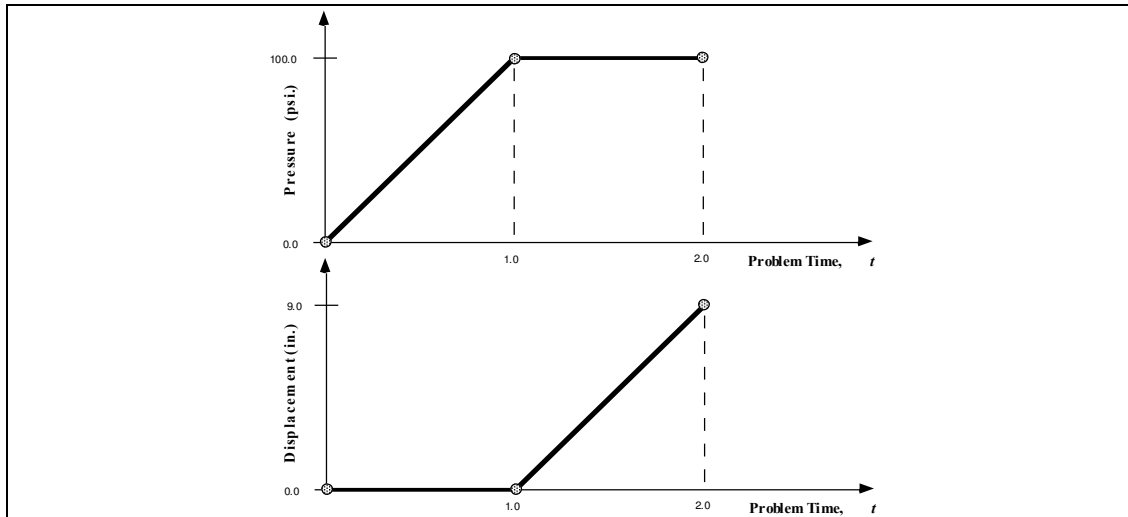
Loading is applied using the same keywords as in explicit analysis. Load curves are used to control the magnitude of each load as the simulation proceeds. Typically, the magnitude of each load begins at zero, and is increased to its full value at the end of the last step in the simulation. In this case, the load curve may be defined using only two points.

For example, consider a static analysis where a pressure of 100 psi. is to be applied in 4 steps. Since the analysis is static, the step size can be chosen arbitrarily. For convenience, choose a step size of 0.25, giving a termination time of 1.0. For this problem, the load curve has only two points: (0.0, 0.0) and (1.0, 100.0). LS-DYNA will automatically use linear interpolation to determine the load magnitude at each of the intermediate steps.

In a more complex example, consider a static problem with two types of loading. First, a static pressure of 100 psi. is to be applied, followed by a prescribed displacement of 9 inches. Two



load curves are used for this problem, one to control the pressure, and one for the displacement, as shown below. Notice that the displacement is prescribed to be zero while the pressure is applied, then the pressure is held constant while the displacement is applied.



Load curves for a static simulation with two loading events. For convenience in this static simulation, the pressure loading is specified to begin at time 0.0 and end at time 1.0, and the displacement begins at time 1.0 and ends at time 2.0.

## AUTOMATIC TIME STEP SIZE CONTROL

In the most simple multi-step nonlinear implicit analysis, the user specifies the termination time using the `*CONTROL_TERMINATION` keyword, and the time step size using the `*CONTROL_IMPLICIT_GENERAL` keyword, and each step is the same size. But for many simulations, the degree of nonlinearity varies through the course of the analysis. In this case the step size should ideally be varied such that solving for equilibrium in each step is equally difficult. This is accomplished by invoking automatic time step control, using the `*CONTROL_IMPLICIT_AUTO` keyword.

There are two advantages to using automatic time step control. First, the time step size is automatically increased and/or decreased in response to the nonlinearity of the analysis. Nonlinearity is measured simply by the number of iterations required to reach equilibrium. An additional advantage is that if the equilibrium search fails during a time step, LS-DYNA does not terminate. Instead, the step is automatically repeated using a different step size. This process of backing up and retrying difficult steps lends much persistence to the analysis, and is often the only procedure for solving highly nonlinear problems short of adjusting the step size manually.

The input parameters for automatic time step control allow specification of the optimum number of equilibrium iterations per step. This indicates how hard LS-DYNA should work in each time step. If equilibrium is reached in fewer than optimum iterations, the size of the next step is

## APPENDIX P

---

increased, and likewise if the equilibrium search requires more than the optimum number of iterations, then the next step size is decreased. Minimum and maximum limits for step size are also input.

### IMPLICIT STRESS INITIALIZATION

A common application of the implicit method is to perform static stress initialization for an explicit dynamic calculation. This can be done using two individual calculations, or by switching methods during a calculation. In the first approach, the keyword `*INTERFACE_SPRINGBACK_LSDYNA` is used to generate a "dynain" output file at the end of the simulation. This file is written in keyword format at the end of the simulation, and contains `*NODE`, `*ELEMENT`, and `*INITIAL_STRESS` data. The dynain file can be included into a second input deck to initialize the explicit dynamic analysis.

LS-DYNA can switch "on-the-fly" between the implicit and explicit methods. To use this feature, define a curve which indicates which formulation to use as a function of simulation time. Formulation switching incurs no overhead, and may be performed several times during a simulation. See the `IMFLAG` parameter on the `*CONTROL_IMPLICIT_GENERAL` keyword for more information.

### TROUBLESHOOTING CONVERGENCE PROBLEMS

Convergence of the nonlinear equilibrium iteration process presents one of the greatest challenges to using the implicit mode of LS-DYNA. Below are some useful troubleshooting approaches:

#### Eigenvalue Analysis

Many convergence problems in static implicit analysis are caused by unconstrained rigid body modes. These are created when an insufficient number of constraints are applied to the model, or when individual model parts are left disconnected. Eigenvalue analysis is an excellent diagnostic tool to check for these problems.

To perform an eigenvalue analysis, simply add the `*CONTROL_IMPLICIT_EIGENVALUE` keyword to an implicit input deck. Use the first parameter `NEIGV=20` to compute the lowest 20 modes. Then view the frequencies in the output text file "eigout" and animate the mode shapes in the binary output file `d3eigv` using LS-PREPOST. Look for frequencies which are nearly zero. Add constraints as necessary to eliminate unconstrained motion.

#### D3ITER Plot Database

To diagnose convergence trouble which develops in the middle of a simulation, get a picture of the deformed mesh. Adjust the `d3plot` output interval to produce an output state after every step leading up to the problematic time.

An additional binary plot database named “d3iter” is available which shows the deformed mesh during each equilibrium iteration. This output is activated and de-activated interactively by entering "<ctrl-c> iteration". View this database using LS-PREPOST. Note that stress data is not included. Frequently the problem will become obvious, especially as deformation is magnified.

### Prescribed Motion with Death Time

A common static analysis problem occurs when small contact gaps exist between parts at time=0. An example is a load-driven punch which deforms a panel, with a small initial contact gap. This creates instantaneous unconstrained rigid body modes until contact between parts is established. (These modes will be obvious in an eigenvalue analysis, as described above.) To overcome this problem, apply a prescribed motion boundary condition to move the parts into contact. Once contact is established, use the optional death time to “kill” the prescribed motion, and allow the applied force or pressure to provide further loading. Monitor reaction forces from the prescribed motion, and adjust the applied loads to match reasonably well at the death time.



**APPENDIX Q: User Defined Weld Failure**

The addition of a user weld failure subroutine into LS-DYNA is relatively simple. The UWELDFAIL subroutine is called every time step when OPT=2 is specified in MAT\_SPOTWELD. As data, the identification number for the spotweld material, six constants specified in the input by the locations NRR through MTT, the radius of the cross section of the spotwelds, the current time, and the current values of the resultants for the spotwelds, which are stored in array STRR, are passed to the subroutine. The subroutine loops over the welds from LFT through LLT, and sets the values of the failure flag array FLAG.

```

      SUBROUTINE UWELDFAIL (IDWELD, STRR, FAIL, FIBL, CM, TT, LFT, LLT)
C*****
C|  LIVERMORE SOFTWARE TECHNOLOGY CORPORATION   (LSTC)           |
C|  -----|
C|  COPYRIGHT 2002 JOHN O. HALLQUIST, LSTC       |
C|  ALL RIGHTS RESERVED                          |
C*****
C
C***  SPOTWELD FAILURE ROUTINE
C
C***  LOCAL COORDINATES: X IS TANGENT TO BEAM, Y & Z ARE NORMAL
C
C***  VARIABLES
C      IDWELD ---- WELD ID NUMBER
C      STRR ----- STRESS RESULTANTS
C                  (1) AXIAL (X DIRECTION) FORCE
C                  (2) Y SHEAR FORCE
C                  (3) Z SHEAR FORCE
C                  (4) MOMENT ABOUT Z
C                  (5) MOMENT ABOUT Y
C                  (6) TORSIONAL RESULTANT
C      FAIL ----- FAILURE FLAG
C                  =0 NOT FAILED
C                  =1 FAIL ELEMENT
C      FIBL ----- LOCATION (1,*) GIVES THE SPOTWELD DIAMETER
C      CM ----- 6 CONSTANTS SUPPLIED BY USER
C      TT ----- CURRENT SIMULATION TIME
C      LFT,LLT --- DO-LOOP RANGE FOR STRR
C
      DIMENSION IDWELD(*), STRR(6,*), FAIL(*), CM(*), FIBL(5,*)
C
C
      RETURN
      END

```



## APPENDIX R: User Defined Cohesive Model

The addition of a user cohesive material subroutine into LS-DYNA is relatively simple. The UMATiC subroutine is called every time step where *i* ranges from 41 to 50. Input for the material model follows the \*MAT\_USER\_DEFINED\_MATERIAL definition. The user has the option of providing either a scalar or vectorized subroutine. As discussed in the Remarks for the user-defined material, the first two material parameters are reserved to specify how the density is treated and the number of integration points required for the failure of the element.

The cohesive model calculates the tractions on the mid-surface of the element as a function of the differences of the displacements and velocities of the upper (defined by nodes 5-6-7-8) and lower surfaces (defined by nodes 1-2-3-4). The displacements, velocities, and the calculated tractions are in the local coordinate system of the element, where the first two components of the vectors are in the plane of the mid-surface and the third component is normal to the mid-surface.

A stiffness must also be calculated by the user for the explicit time step calculation in LS-DYNA. This stiffness must provide an upper bound on the stiffness in all three directions.

The material fails at an integration point when *ifail=.true.* For an element to be deleted from the calculation, the number of integration points specified by the second material parameter must fail. If the second parameter is zero, elements cannot fail regardless of the specification of IFAIL in the user-defined material input.

The following example is a vectorized model with two elastic constants and failure:

```

      subroutine umat41c(idpart,cm,lft,llt,fc,dx,dxdt,aux,ek,
&                    ifail,dtlsiz,crv)
      include 'nlqparm'
c
c*** vector cohesive material user model example
c
c*** variables
c      idpart ---- Part ID
c      cm ----- material constants
c      lft,llt --- start and end of block
c      fc ----- components of the cohesive force
c      dx ----- components of the displacement
c      dxdt ----- components of the velocity
c      aux ----- history storage
c      ek ----- max. stiffness/area for time step calculation
c      ifail ---- =.false. not failed
c                  =.true. failed
c      dtlsiz ---- time step size
c      crv ----- curve array
c
c*** dx, dxdt, and fc are in the local coordinate system:
c      components 1 and 2 are in the plane of the cohesive surface
c      component 3 is normal to the plane
c
c*** cm storage convention
c      (1) =0 density is per area

```

## APPENDIX R

---

```
c      =1 density is per volume
c      (2) number of integration points for element deletion
c      =0 no deletion
c      (3:48) material model constants
c
c      logical ifail
c      dimension cm(*),fc(nlq,*),dx(nlq,*),dxdt(nlq,*),
&          aux(nlq,*),ek(*),ifail(*),dtlsiz(*),crv(101,2,*)
c
c      et=cm(3)
c      en=cm(4)
c      eki=max(et,en)
c      fcfail=cm(5)
c
c      do i=lft,llt
c          fc(i,1)=et*dx(i,1)
c          fc(i,2)=et*dx(i,2)
c          fc(i,3)=en*dx(i,3)
c          ek(i)=eki
c          ifail(i)=fc(i,3).gt.fcfail
c      enddo
c
c      return
c      end
```

The second example implements the Tveergard-Hutchinson cohesive model with failure in both the vectorized (UMAT42C) and scalar (UMAT43C) forms. Note the LFT and LLT are passed to the scalar version, however their value is zero.

```
      subroutine umat42c(idpart,params,lft,llt,fTraction,jump_u,dxdt,
&          aux,ek,ifail,dtlsiz,crv)
      include 'nlqparm'
c
c***  vector cohesive material user model example
c
c***  variables
c      idpart ---- part ID
c      params ---- material constants
c      lft,llt --- start and end of block
c      fTraction - components of the cohesive force
c      jump_u ---- components of the displacement
c      dxdt ----- components of the velocity
c      aux ----- history storage
c      ek ----- max. stiffness/area for time step calculation
c      ifail ----- =.false. not failed
c                  =.true. failed
c      dtlsiz ---- time step size
c      crv ----- curve array
c
c***  jump_u, dxdt, and fTraction are in the local coordinate system:
c      components 1 and 2 are in the plane of the cohesive surface
c      component 3 is normal to the plane
c
c***  cm storage convention
```



```

c      (1) =0 density is per area
c          =1 density is per volume
c      (2) number of integration points for element deletion
c          =0 no deletion
c      (3:48) material model constants
c
c      Tveergard-Hutchinson model based on:
c      tahoe/src/elements/cohesive_surface/cohesive_models/TvergHutch3DT.cpp
c
c      the declaration below is processed by the C preprocessor and
c      is real*4 or real*8 depending on whether LS-DYNA is single or double
c      precision
c      REAL L,jump_u

      logical ifail
      dimension params(*),fTraction(nlq,*),jump_u(nlq,*),
&          dxdt(nlq,*),aux(nlq,*),ek(*),ifail(*),dtlsiz(*),
&          crv(101,2,*)

      fsigma_max=params(3)
      fd_c_n=params(4)
      fd_c_t=params(5)
      fL_1=params(6)
      fL_2=params(7)
      fpenalty=params(8)

      fK=fpenalty*fsigma_max/(fL_1*fd_c_n)

      fac=min(fd_c_n/fd_c_t**2,1./fd_c_n)

      do i=1ft,1lt
      u_t1 = jump_u(i,1)
      u_t2 = jump_u(i,2)
      u_n = jump_u(i,3)

      r_t1 = u_t1/fd_c_t
      r_t2 = u_t2/fd_c_t
      r_n = u_n/fd_c_n
      L = sqrt(r_t1*r_t1 + r_t2*r_t2 + r_n*r_n)

      if (L .lt. fL_1) then
          sigbyL=fsigma_max/fL_1
      else if (L .lt. fL_2) then
          sigbyL = fsigma_max/L
      else if (L .lt. 1.) then
          sigbyL = fsigma_max*(1. - L)/(1. - fL_2)/L
      else
          sigbyL = 0.0
          ifail(i)=.true.
      endif

      fTraction(i,1) = sigbyL*r_t1*(fd_c_n/fd_c_t)
      fTraction(i,2) = sigbyL*r_t2*(fd_c_n/fd_c_t)
      fTraction(i,3) = sigbyL*r_n

c      penetration
      if (u_n .lt. 0) fTraction(i,3)=fTraction(i,3)+fK*u_n

```

## APPENDIX R

---

```
c      approximate stiffness for time step
      if (u_n .lt. 0) then
        ek(i)=fac*sigbyL+fK
      else
        ek(i)=fac*sigbyL
      endif

      enddo

      return
    end
    subroutine umat43c(idpart,params,lft,llt,fTraction,jump_u,dxdt,
&                    aux,ek,ifail,dtlsiz,crv)
c
c***  scalar cohesive material user model example
c
c***  variables
c      idpart ---- part ID
c      params ---- material constants

c      lft,llt --- start and end of block
c      fTraction - components of the cohesive force
c      jump_u ---- components of the displacement
c      dxdt ----- components of the velocity
c      aux ----- history storage
c      ek ----- max. stiffness/area for time step calculation
c      ifail ----- =.false. not failed
c                  =.true. failed
c      dtlsiz ---- time step size
c      crv ----- curve array
c
c***  jump_u, dxdt, and fTraction are in the local coordinate system:
c      components 1 and 2 are in the plane of the cohesive surface
c      component 3 is normal to the plane
c
c***  cm storage convention
c      (1) =0 density is per area
c          =1 density is per volume
c      (2) number of integration points for element deletion
c          =0 no deletion
c      (3:48) material model constants
c
c      Tveergard-Hutchinson model based on:
c      tahoe/src/elements/cohesive_surface/cohesive_models/TvergHutch3DT.cpp

c      the declaration below is processed by the C preprocessor and
c      is real*4 or real*8 depending on whether LS-DYNA is single or double
c      precision
      REAL L,jump_u

      logical ifail
      dimension params(*),fTraction(*),jump_u(*),
&              dxdt(*),aux(*),crv(101,2,*)

      fsigma_max=params(3)
      fd_c_n=params(4)
```

```
fd_c_t=params(5)
fL_1=params(6)
fL_2=params(7)
fpenalty=params(8)

fK=fpenalty*fsigma_max/(fL_1*fd_c_n)

fac=min(fd_c_n/fd_c_t**2,1./fd_c_n)

u_t1 = jump_u(1)
u_t2 = jump_u(2)
u_n = jump_u(3)

r_t1 = u_t1/fd_c_t
r_t2 = u_t2/fd_c_t
r_n = u_n/fd_c_n
L = sqrt(r_t1*r_t1 + r_t2*r_t2 + r_n*r_n)

if (L .lt. fL_1) then
  sigbyL=fsigma_max/fL_1
else if (L .lt. fL_2) then
  sigbyL = fsigma_max/L
else if (L .lt. 1.) then
  sigbyL = fsigma_max*(1. - L)/(1. - fL_2)/L
else
  sigbyL = 0.0

ifail=.true.
endif

fTraction(1) = sigbyL*r_t1*(fd_c_n/fd_c_t)
fTraction(2) = sigbyL*r_t2*(fd_c_n/fd_c_t)
fTraction(3) = sigbyL*r_n

c penetration
if (u_n .lt. 0) fTraction(3)=fTraction(3)+fK*u_n

c approximate stiffness for time step
if (u_n .lt. 0) then
  ek=fac*sigbyL+fK
else
  ek=fac*sigbyL
endif

return
end
```



**APPENDIX S: User Defined Boundary Flux**

A user defined boundary flux interface is provided in LS-DYNA where it is possible to define the thermal heat flux (power per surface area) in or out of a surface segment as an arbitrary function of temperature and history. The user may associate history variables with each individual flux interface and also use load curves.

The user flux interface is invoked using the keyword \*BOUNDARY\_FLUX\_OPTION. This is accomplished with the parameter NHISV. When it is defined with a value greater than 0, the user subroutine

```
subroutine usrflux(fl, flp, ...)
```

is called to compute the flux (fl) defined as heat (energy) per time and per surface area.

Other parameters that are passed to the user flux subroutine include the segment nodal temperatures at the previous ( $T_0$ ) and current time ( $T_1$ ), the segment nodal coordinates and the time integration parameter  $\alpha$ . Also, the current thermal simulation time  $t$ , the time step  $\Delta t$  and average segment temperature ( $T_a$ ) at time  $t+\alpha\Delta t$  is provided together with the curve array for accessing defined load curves in the keyword input file. For computing load curve values, note that load curve IDs need to be transformed to internal numbers or the subroutine crvval should be used, see the appendix on user defined materials for details.

The segment coordinates available in the subroutine are such that the outward normal vector follows the well-known right-hand rule, thus segments corresponding to the lower surface of thick thermal shells are reversed before passed to the subroutine. For shells in general, the segment connectivity should follow the connectivity of the actual shell element to avoid problems.

Optionally, the user may define the derivative of the flux fl with respect to the average segment temperature ( $T_a$ ) at time  $t+\alpha\Delta t$ , flp. This value is used in the nonlinear thermal solver for assembling the correct stiffness matrix and must be set by the user. If possible, it is recommended to use a value that reflects the nonlinearity of the flux model, otherwise the value 0 should be used.

An array of history variables, identical with the input parameters defined in the keyword input file, are passed to the subroutine that can be updated with time or kept constant throughout the simulation. An example of usage would be to integrate the flux with time to keep track of the dissipated energy per surface area in order to simulate the effects of spray cooling in hot-stamping.

```
subroutine usrflux(fl, flp, x, tnpl, tnl, nodes,
.      alpha, atime, atemp, dt, time, fhsv, nfhsv, crv)
C*****
C|  LIVERMORE SOFTWARE TECHNOLOGY CORPORATION  (LSTC)  |
C|  -----  |
C|  COPYRIGHT © 2007 JOHN O. HALLQUIST, LSTC  |
C|  ALL RIGHTS RESERVED  |
```

# APPENDIX S

---

```
C*****
C
C      User subroutine for boundary thermal flux
C
C      Purpose: To define thermal flux parameter (heat per surface area and
C      time)
C
C      Variables:
C
C      fl           = flux intensity (output)
C      flp          = flux intensity derivative wrt atemp (output)
C      x(3,nodes)  = global segment coordinates (input)
C      tnpl(nodes) = temperatures at time time (input)
C      tnl(nodes)  = temperatures at time time-dt (input)
C      nodes       = number of nodes in segment (3,4 or 6) (input)
C      alpha       = time integration parameter (input)
C      atime       = time+(alpha-1)*dt
C      atemp       = average segment temperature at time atime
C      dt          = time step size (input)
C      time        = time at which the new temperature is sought (input)
C      fhsv(nfhsv) = flux history variables (input/output)
C      nfhsv       = number of flux history variables for this segment
C                  (input)
C      crv         = curve array (input)
C
C      include 'nlqparm'
C      dimension x(3,*),tnpl(*),tnl(*)
C      dimension fhsv(*),crv(lq1,2,*)
C
C      Define flux by linear convection
C      that optionally decays (in an ad-hoc way) as power
C      dissipates from surface
C
C      fhsv(1) = convection coefficient
C      fhsv(2) = ambient temperature
C      fhsv(3) = total amount of energy per surface area available
C      fhsv(4) = dissipated energy per surface area at current
C
C      hcon=fhsv(1)
C      tinf=fhsv(2)
C      flin=hcon*(tinf-atemp)
C      if (nfhsv.gt.2) then
C          q=(1.-fhsv(4)/fhsv(3))/
C          .   (1.+5*dt*flin/fhsv(3))
C          flp=-q*hcon
C          if (q.gt.1.) then
C              q=1.
C              flp=-hcon
C          elseif (q.lt.0.) then
C              q=0.
C              flp=0.
C          endif
C          fl=q*flin
C          fhsv(4)=fhsv(4)+dt*.5*fl
C          fhsv(4)=min(fhsv(3),fhsv(4))
C      else
C          fl=flin
```

```
        flp=-hcon
    endif
c
    return
end
```