

**ANSYS**

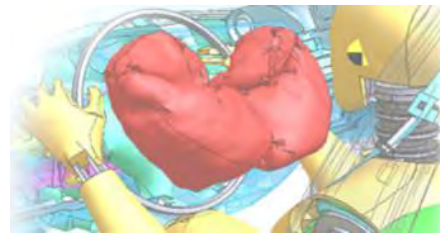

**JSOL**



**LST**



**OASYS**

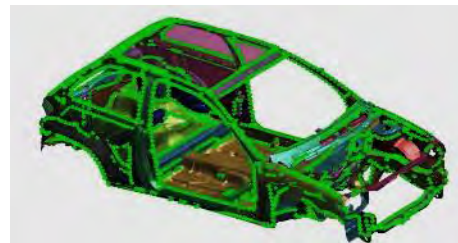

**LS-DYNA® New Feature and Application**

- On Setting up a Structured ALE Model
- Multiaxial fatigue analysis with LS-DYNA



---

*FEA Information Engineering Solutions*

[www.feapublications.com](http://www.feapublications.com)

The focus is engineering technical solutions/information.

**Livermore Software Technology, an ANSYS company**

Development of LS-DYNA, LS-PrePost, LS-OPT,

LS-TaSC (Topology), Dummy & Barrier models and

Tire models for use in various industries.

[www.lstc.com](http://www.lstc.com)

To sign up for the FEA News send an email - subject "subscribe" to [news@feainformation.com](mailto:news@feainformation.com)

To be removed from the FEA News send an email - subject "Remove" to [news@feainformation.com](mailto:news@feainformation.com)

**If you have any questions, suggestions or recommended changes, please contact us.**

**Editor and Contact: Yanhua Zhao - [news@feainformation.com](mailto:news@feainformation.com)**

# Platinum Participants

---

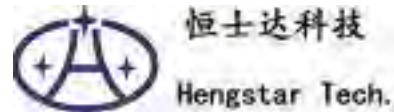

# Table of contents

02 FEA Information Inc. Profile  
04 TOC

03 Platinum Participants  
05 Announcements

## Articles – Blogs – News

06	ANSYS	How the SAE J3168 Standard Will Improve Automotive Electronic Hardware
10	BETA CAE Systems	BETA CAE Systems announces the release of the v21.1.0 of its software suite
11	d3View	Multiple Application, One Platform
12	DYNAmore GmbH	13th European LS-DYNA Conference October 5-6, 2021, Ulm, Germany
13		Webinars and Video-Seminars 2021
14	ESI Group	ESI Contributes to Nissan's Breakthrough in Carbon Fiber Parts Production for Safer and Lighter Vehicles
16	ETA	ETA Inc., Engineering Technology Associates Announces DYNAmore as Master Distributor in Europe
17	FEA Not To Miss	Simulation and Articles
18	Hengstar Technology	Online workshop of SPH theory and applications in LS-DYNA
19	JSOL	Airbag folding - JFOLD
20	KAIZENAT	Kaizen-DYNA App
21	LST	On Setting up a Structured ALE Model
29		LS-PrePost® an Advanced Pre- and Post-processor
30	Material-Sciences	Engineering Services
31	OASYS	Webinar Oasys PRIMER - Spotwelding and Connections 26th January 2021
32		Oasys and LS-DYNA training courses 2021
33	Predictive Engineering	Fatigue Analysis: ASME Section VIII, Division 2, Part 5.5 Protection Against Failure from Cyclic Loading
35	Rescale	Rescale Named to Y Combinator's Top Companies List
36	Shanghai Fangkun	Shanghai Fangkun Software Technology Ltd
38	Terrabyte	Products, Sales, Consulting

## Automotive News, Resource links, LS-DYNA Training

39	ALL-NEW FORD F-150 AND MUSTANG MACH-E EARN NORTH AMERICAN TRUCK AND UTILITY OF THE YEAR HONORS
41	LS-DYNA – Resource Links
42	Training - Webinars
43	LS-DYNA LIVE ONLINE TRAINING & CONSULTING SERVICES

## LS-DYNA New Feature and Application

44	Multiaxial fatigue analysis with LS-DYNA®
----	---

## Resources

58	Engineering Solutions
67	Cloud - HPC Services - Subscription

72	ATD - Barrier - THUMS
75	Social Media

# Announcements

---

ANSYS have decided to continue the publication of FEA Information solution and the newsletter in 2021.

We sincerely thank all of our participants and readers over the 20 years of this publication. We hope you continue to support us.

## About ANSYS, Inc.

If you've ever seen a rocket launch, flown on an airplane, driven a car, used a computer, touched a mobile device, crossed a bridge or put on wearable technology, chances are you've used a product where ANSYS software played a critical role in its creation. ANSYS is the global leader in engineering simulation. Through our strategy of Pervasive Engineering Simulation, we help the world's most innovative companies deliver radically better products to their customers. By offering the best and broadest portfolio of engineering simulation software, we help them solve the most complex design challenges and create products limited only by imagination. Founded in 1970, ANSYS is headquartered south of Pittsburgh, Pennsylvania, U.S.A., Visit [www.ansys.com](http://www.ansys.com) for more information.

ANSYS and any and all ANSYS, Inc. brand, product, service and feature names, logos and slogans are registered trademarks or trademarks of ANSYS, Inc. or its subsidiaries in the United States or other countries. All other brand, product, service and feature names or trademarks are the property of their respective owners.

[Ansysis Website](http://www.ansys.com)

[Ansysis Blog](http://www.ansys.com/blog)





# Ansys Blog

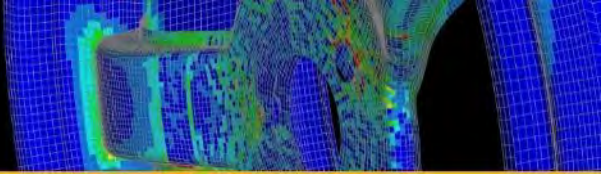

Published on January 6, 2021 by Theresa Duncan, Craig Hillman  
 Electronics, Automotive, Aerospace and Defense  
 Electronics, Printed Circuit Board (PCB) Design, Semiconductors, Ansys Sherlock, Ansys Icepak, Ansys Mechanical

## How the SAE J3168 Standard Will Improve Automotive Electronic Hardware

The race is on for fully autonomous vehicles. Industry giants like Tesla, Google, Uber and almost all major automotive companies are competing to deliver state-of-the-art self-driving vehicles.

However, the development of new, cutting-edge technologies demands a similar wave of reliability, repairability and warranty standards that automotive manufacturers must implement as technological capabilities reach new heights.

### A New Era of Electronic Reliability Standards



*Automotive Electronics typically account for at least 35% of a modern automobile.*

“Electronics will account for 35% of the cost of a car soon ... and with autonomous driving coming by 2030, PWC thinks it will soon account for 50% of the car,” writes Michael Schuldenfrei in a recent Semiconductor Engineering article. Schuldenfrei is corporate technology fellow at Optimal Plus. “If you think about where cars are today and where they’re going to be tomorrow, this is a problem.”

Consumers are much less likely to purchase a vehicle from a manufacturer if the vehicle’s electronics experience repeated failures, and some original equipment manufacturers (OEMs) are even calling for automotive electronics that last up to 20 years. To meet this demand, automotive manufacturers will need to implement new standards and workflows that produce electronic hardware that is reliable and repairable, and that have much longer warranties.

[Learn more about automotive electronics reliability challenges.](#)

### What is the SAE J3168 Standard?



*SAE J3168 is the first reliability physics analysis (RPA) standard developed specifically for use in the aerospace, automotive, defense and other high-performance (AADHP) industries.*

In 2020, the SAE Automotive Electronic Systems Reliability Standards Committee and the SAE Avionics Process Management Committee passed the SAE J3168 standard: “Reliability Physics Analysis of Electrical, Electronic, Electromechanical Equipment, Modules and Components.” It is the first reliability physics analysis (RPA) standard developed specifically for use in the aerospace, automotive, defense and other high-performance (AADHP) industries.

The use of RPA has proliferated in the last two decades, but there is wide variation in the ways it has been conducted. The potential for inconsistency and misinterpretation has increased as technology has progressed, leading to the development of SAE J3168 to formalize a consensus among users and document standard methods to apply RPA to electrical, electronic and electromechanical (EEE) equipment, modules and components.

RPA is the process of using scientifically derived algorithms and robust simulation techniques to predict how the evolution of physical, chemical, mechanical, thermal or electrical mechanisms cause degradation and eventually induce failure. All engineers involved in design and validation can leverage RPA to identify and mitigate potential risks before hardware prototyping, saving their organizations resources, time and unforeseen costs.

[Learn more about a workflow combining Ansys Sherlock, Icepak and Mechanical to evaluate the reliability of electronic systems in autonomous vehicles.](#)

## Improving Automotive Electronics Reliability with SAE J3168

SAE J3168 describes a baseline process to assess board-level reliability and durability with respect to five major potential failure mechanisms:

1. Solder joint fatigue due to thermal cycling
2. Solder attachment fatigue due to vibration
3. Solder joint failure due to mechanical shock
4. Printed circuit board (PCB) via hole fatigue due to thermal cycling
5. Aging and wear out of microcircuits due to electromigration, oxide breakdown, bias temperature instability and hot carrier injection.

The SAE J3168 standard lays out an industry-accepted minimum approach for assessing each mechanism.

For example, the first step in evaluating the risk of solder fatigue due to thermal cycling requires a strong understanding of the potential environment. Minimum and maximum temperatures, ramp rates and dwell times must all be accounted for. Localized temperature increases due to power dissipation must also be captured. This requires a seamless integration between your RPA tool and thermal analysis results.

This is the exact workflow implemented by Ansys, where Ansys Sherlock (RPA) and Ansys Icepak (thermal analysis) have a unique two-way exchange of information. This provides confidence to the end customer that all important parameters of solder fatigue have been incorporated into the RPA activity.

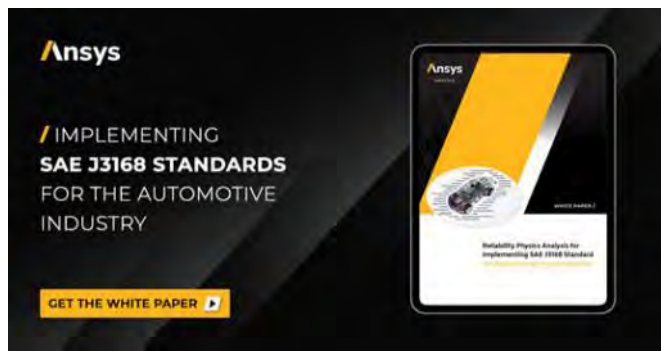

Read the “Reliability Physics Analysis for Implementing SAE J3168” White paper to learn more about SAE J3168 Implementation with Ansys Sherlock.

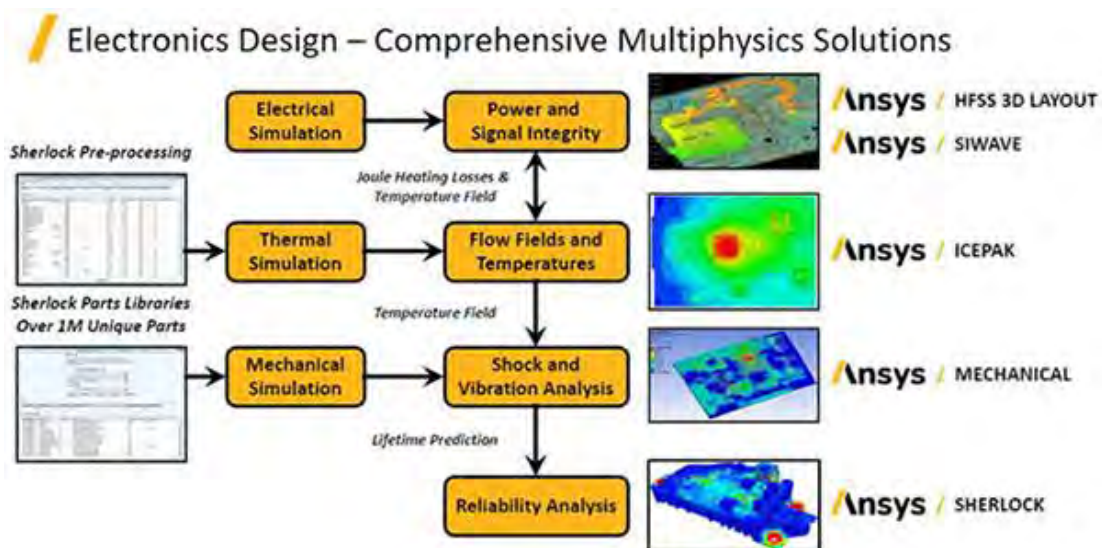

An integrated electronics reliability workflow with Ansys HFSS, Icepak, Mechanical, Sherlock and Siwave. Request an electronics reliability demo.



[Request an electronics reliability demo.](#)

Incorporating detailed design information is also critical. Assumptions about part and PCB geometry can lead to significant deviations between prediction and actual performance during validation testing. Sherlock supports this requirement in two ways.

The first is through its comprehensive part and package libraries that contain detailed information on external dimensions as well as die, overmold, lead and solder ball geometry. This library is not static and can be tailored and enhanced per specific customer requests.

The second way Sherlock supports detailed design information is via its ability to parse electronic computer-aided engineering (ECAD) files and provide the user with a wide variety of geometries and element types ready for finite element analysis (FEA). These include layers with effective properties, trace meshing, trace modeling and reinforcements. This one-of-a-kind capability among CAE tools provides Sherlock users with key insight into PCB features, such as bond pad sizing and via stacks, that play an increasingly important role in solder joint failure.



Testing and analysis are critical components for developing reliable electronic products. It is essential that design engineers and electronic manufacturers have access to simulation tools that can simulate use environments and potential failure mechanisms, and determine if the product meets the standards laid out in SAE J3168. As technology progresses, simulation tools will become the primary solution for solving reliability and failure risks early in the product design stage without having to rely on physical testing.

Automotive external aerodynamics simulations require a high level of accuracy in a short amount of time. Because of the large, complex geometries and domain size needed, pre-processing and solving time can be significant.

[Read from website](#)

Ansys has been making great progress in accelerating the pre-processing and solving time for these types of simulations. [Ansys Fluent](#) has added new features and capabilities to generate a high-quality mesh quickly and efficiently, including:

- Task-based workflows for clean and dirty computer-aided design (CAD) geometries.
- Automation and customization.

Developing CAE software systems for all simulation disciplines. Products: ANSA pre-processor/ EPILYSIS solver and META post-processor suite, and SPDRM, the simulation-process-data-and-resources manager, for a range of industries, incl. the automotive, railway vehicles, aerospace, motorsports, chemical processes engineering, energy, electronics...

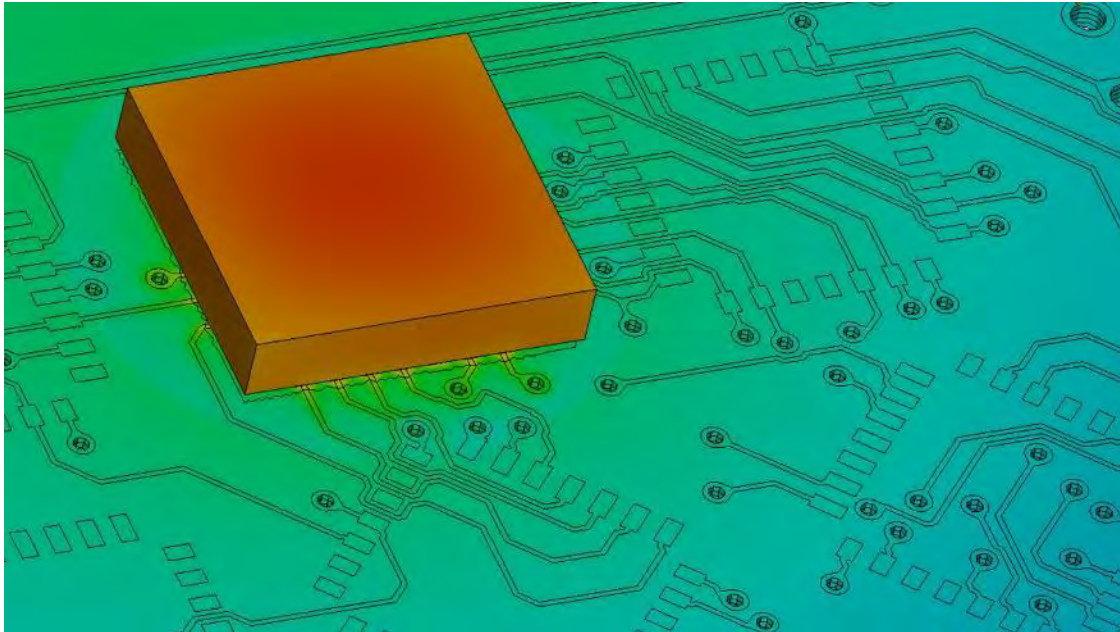

December 28, 2020

## BETA CAE Systems announces the release of the v21.1.0 of its software suite

### About this release

Consistently trying to minimize simulation turnaround time and accelerate the automatic setup for workflows and processes, BETA CAE Systems proudly presents the release of v21.1.0 of its software suite.

The brand new version offers a plethora of features to unlock new potential for simulation in design and analysis, as well as a range of upgrades and performance improvements for existing workflows.

### Do not miss:

- The promising entries of Electronic CAD (eCAD) and Electromagnetics, as well as Thermal for structural applications, as simulation fields of analysis.
- The progressing NVH capabilities from pre- to post-processing.
- The impressively accelerated performance in Crash & Safety post-processing processes.
- The augmented pre-processing potential with the advancements in ANSA VR.
- The continuously enriched capabilities of Machine Learning integration in KOMVOS through ANSA.

### Contents

[Release Highlights](#)

[Compatibility and Supported Platforms](#)

[Download](#)

[Read full article from website](#)

d3VIEW is a data to decision platform that provides out-of-the box data extraction, transformation and interactive visualizations. Using d3VIEW, you can visualize, mine and analyze the data quickly to enable faster and better decisions.



**You Make Faster Decisions**  
You review and study information dashboards, visualizations, structured data, etc.

**We Prepare Your Data**  
We process no-code data integrations, transformations, extractions, complex workflows, etc.

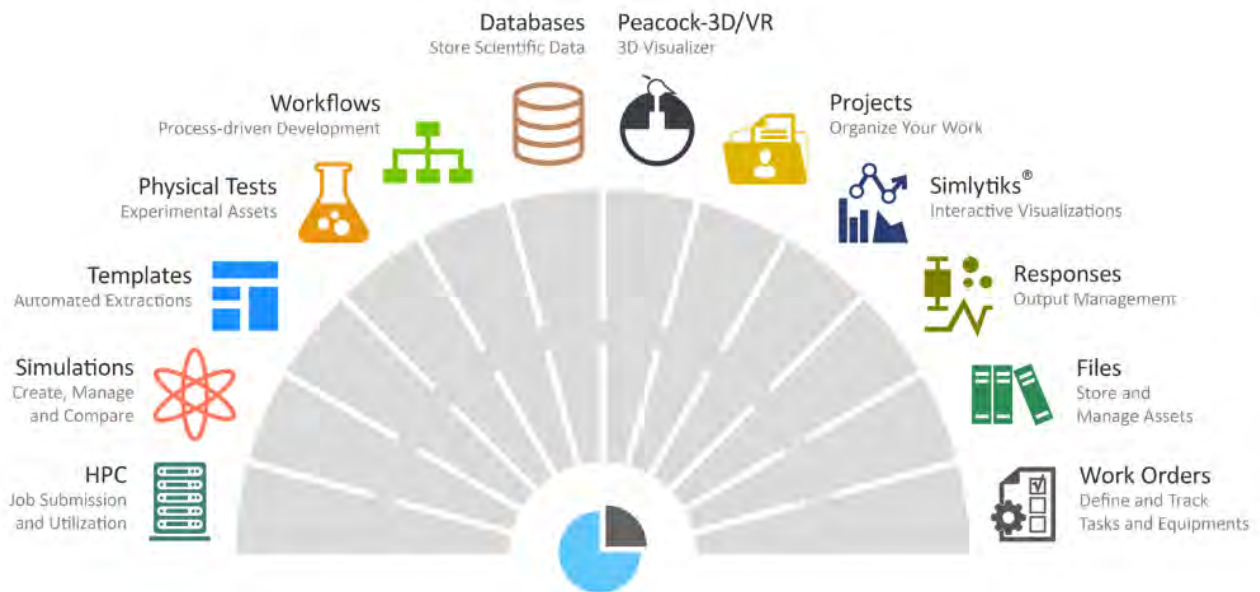

Multiple Applications, One Platform.

[www.d3view.com](http://www.d3view.com) | [support@d3view.com](mailto:support@d3view.com)



Save the date!

## 13<sup>th</sup> European LS-DYNA Conference October 5-6, 2021, Ulm, Germany

Conference Website: [www.dynamore.de/en/conf2021](http://www.dynamore.de/en/conf2021)

### Invitation

We very much hope for a normalization of the situation and that we will be able to welcome the LS-DYNA users personally at a conference again next fall. We kindly invite all users of LS-DYNA, LS-OPT, and LS-TaSC to the 13<sup>th</sup> European LS-DYNA Conference at October 5-6, 2021 in Ulm, Germany. As usually the conference will be a great opportunity to talk with industry experts, catch up with colleagues and enjoy time exploring new ideas. In addition, attendees can meet with exhibitors to learn about the latest hardware and software trends as well as additional services relating to the finite element solver LS-DYNA, the optimization codes LS-OPT and LS-TaSC, and the pre- and postprocessor LS-PrePost. Training courses and workshops will also take place in the week before, during and after the conference.

### Venue

The Congress Centrum Ulm is located directly on the river Danube. The city is best known for its cathedral, the highest church tower in the world and for being the birthplace of Albert Einstein.

Ulm is located directly on the A7 and A8 motorways and can be easily reached from Stuttgart and Munich airports.

Address:

Basteistraße 40

89073 Ulm

Telefon: +49 731 922990

Telefax: +49 731 9229930

[www.ulm-messe.de](http://www.ulm-messe.de)

### Abstract submission

Please submit your abstract (maximum length 2,500 characters) by E-Mail to [conf@dynamore.de](mailto:conf@dynamore.de) or online at: [www.dynamore.de/en/2021-abstract](http://www.dynamore.de/en/2021-abstract)

### Important Dates

Abstract submission: May 28, 2021

Author notification: July 9, 2021

Paper submission: September 3, 2021

Conference date: October 5-6, 2021

### Participant fees

Industry speaker: 420 Euro

Academic speaker: 360 Euro

Industry: 640 Euro<sup>1)</sup> / 690 Euro

Academic: 490 Euro<sup>1)</sup> / 540 Euro

<sup>1)</sup> Registration before 30 June 2021. All plus VAT.

### Exhibiting and sponsoring

Please request further information.

### Contact

DYNAmore GmbH

Industriestr. 2, D-70565 Stuttgart, Germany

Tel. +49 (0) 7 11 - 45 96 00 - 0

E-Mail: [conference@dynamore.de](mailto:conference@dynamore.de)

[www.dynamore.de/en/conf2021](http://www.dynamore.de/en/conf2021)





## Webinars and Video-Seminars 2021



### Online trainings from February to April

#### *Webinars LS-DYNA Compact*

Modeling Metallic Materials	8-9 February
Element Types & Nonlinear Aspects	22-24 February
Damage and Failure	22-23 February
Introduction to Isogeometric Analysis with LS-DYNA	1-2 March
Advanced Damage Modeling - Orthotropic Materials	8-9 March
Introduction to SPG Method for Manufacturing and Material Failure Analysis	15-16 March
User Interfaces in LS-DYNA	18 March
Electromagnetism in LS-DYNA	22-23 March
Resistive Heating and Battery Modeling	24 March
Introduction to Simulation Data and Process Management in LoCo	29-30 March
User Materials	31 March
Contact Modeling in LS-DYNA	12 April
Introduction to LS-DYNA	13 April
Joining Techniques in LS-DYNA	14 April
Introduction to Draping Simulation with LS-DYNA	27 April

#### *Video Seminars*

Introduction to LS-DYNA online	anytime
Crashworthiness Simulation with LS-DYNA	anytime
Modeling Metallic Materials	anytime
LS-OPT - Optimization	anytime
LS-OPT - Robustness	anytime

Visit our website for complete overview and registration [www.dynamore.de/en/seminars](http://www.dynamore.de/en/seminars)



A leading innovator in Virtual Prototyping software and services. Specialist in material physics, ESI has developed a unique proficiency in helping industrial manufacturers replace physical prototypes by virtual prototypes, allowing them to virtually manufacture, assemble, test and pre-certify their future products.

## ESI Contributes to Nissan's Breakthrough in Carbon Fiber Parts Production for Safer and Lighter Vehicles

Paris, December 3rd, 2020



**ESI Group, global player in Virtual Prototyping software and services for industry, supports Nissan Motor Co in its production process that speeds up the development of car parts made from carbon fiber reinforced plastics (CFRP). Light yet extremely strong, this material will be used to make safer and more fuel-efficient cars.**

Safety, comfort and autonomy are key outcomes for consumers. To face this situation, automakers continuously innovate in different fields such as lightweight to help them achieve their expected results. For this purpose, the use of new materials can be key. Commonly used in other industries such as Aerospace and with promising capabilities, Carbon Fiber Reinforced Plastics (CFRP) were too time-consuming and too expensive to industrialize for the Automotive sector. *“We have always considered CFRP as a material for future generations of cars. But when it comes to reality, CFRP can be used only for limited models and appears to be more challenging for mass market production. Indeed, costs are high, and complex designs are required to shape CFRP. The challenge was to industrialize its production process in order to reduce costs and development time.”* explains Hideyuki Sakamoto, EVP of Nissan Motor Co.

ESI Group has been supporting Nissan's CFRP challenge since 2015 in the evolution of its industrial product design and manufacturing methodologies for various vehicle models. The partnership was strengthened in 2018 with the CFRP mass production project.

To overcome the difficulty in shaping CFRP parts, Nissan's engineers, helped by ESI's solution, found a new approach: the process of Compression Resin Transfer Molding (C-RTM). The existing method involves forming carbon fiber into the right shape and setting it in a die with a slight gap between the upper die and the carbon fibers. Resin is then injected into the fiber and left to harden. Nissan's engineers developed techniques to accurately simulate the permeability of the resin in carbon fiber, while visualizing resin flow behavior in a die using an in-die temperature sensor and a transparent die. The result of the successful simulation was a high-quality component with shorter development time. Using Virtual Prototype of the product, Nissan succeeded: a high-quality component with a development time reduced by 50% and reduced by 80% of single molding.

*"We are proud of the support we have brought Nissan over the years and throughout this project. We have helped them succeed in the full development process, from the design to the manufacturing of mass-produced CFRP parts, thus enabling their breakthrough for lighter and safer vehicles. Nissan's success embodies our mission to enable industrial players to commit to outcomes. With our Smart Manufacturing solution and our historical expertise in materials, we helped them reach their ambitions,"* concludes Cristel de Rouvray, CEO of ESI Group.

## ESI Group

lorence Barré  
[press@esi-group.com](mailto:press@esi-group.com)  
33 1 49 78 28 28

## Press Relationship – Shan

ola Gozlan  
[lola.gozlan@shan.fr](mailto:lola.gozlan@shan.fr)  
33 6 24 76 83 40

## About ESI Group

Founded in 1973, ESI Group is a leading innovator in Virtual Prototyping solutions and a global enabler of industrial transformation. Thanks to the company's unique know-how in the physics of materials, it has developed and refined, over the last 45 years, advanced simulation capabilities. Having identified gaps in the traditional approach to Product Lifecycle Management (PLM), ESI has introduced a holistic methodology centered on industrial productivity and product performance throughout its entire lifecycle, i.e. Product Performance Lifecycle™, from engineering to manufacturing and in operation. Present in more than 20 countries, and in major industrial sectors, ESI employs 1200 high level specialists. In 2019, its turnover was 146M€. ESI is headquartered in France and is listed on compartment B of Euronext Paris. For further information, go to [www.esi-group.com](http://www.esi-group.com).

[Read from website](#)

ETA has impacted the design and development of numerous products - autos, trains, aircraft, household appliances, and consumer electronics. By enabling engineers to simulate the behavior of these products during manufacture or during their use, ETA has been involved in making these products safer, more durable, lighter weight, and less expensive to develop.



## ETA Inc., Engineering Technology Associates Announces DYNAMore as Master Distributor in Europe

TROY, Michigan (USA) /STUTT GART, Germany – September 8, 2020 –

ETA Inc. (Engineering Technology Associates), an engineering and software innovator with over 37 years in the automotive engineering community, has signed a master distribution agreement with DYNAMore GmbH. DYNAMore is one of the largest distributors of LS-DYNA simulation software worldwide.

“I highly appreciate to further strengthen our long-standing and very good cooperation with ETA and to coordinate the distribution of Dynaform throughout Europe. Together we are well positioned to meet the increasing demands on deep drawing, hydroforming and tube bending simulations.”

**Ulrich Franz, Managing Director, DYNAMore GmbH**

‘It is my pleasure to welcome DYNAMore, our long time Dynaform partner and German distributor as our new Master Distributor for Dynaform in the European Union. I am pleased by DYNAMore’s business expansion, as they increase their presence in new growth markets across Europe.’

**– Dr. Akbar Farahani, CEO & President, ETA Inc.**

ETA and DYNAMore have been the most prominent LS-DYNA distributors for over 25 years. This new partnership will bring both companies closer, strengthen the software sales and support to the end-customer and showcase a unified market expansion to European OEMs’ and suppliers.

ETA and DYNAMore are committed to creating a powerful virtual presence with webinars, online support and training for customers during the current pandemic and beyond.

DYNAMore will lead the following efforts:

- Supporting customers with the 6<sup>th</sup> generation of Dynaform
- Providing assistance to European sub-distributors
- Delivering consistent, streamlined communication for software sales and support throughout Europe

For further information on ETA, please visit [eta.com](http://eta.com)

For further information on DYNAMore, please visit [www.dynamore.de/en](http://www.dynamore.de/en).



Highlights from our FEA Not To Miss Software & Engineering Solutions ISSN 2694-4707 and FEA Not To Miss Website - [Sign up for our Monthly Magazine via email](#)

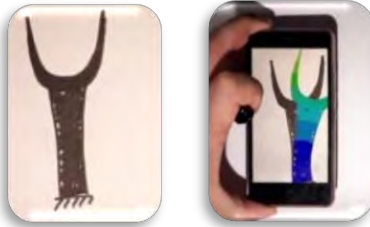

Dr. Markus Kellermeyer - CADFEM - [World of the Simulation Engineer](#) - Things others cannot see!

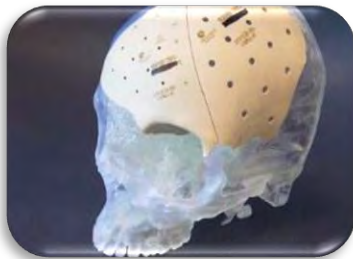

Brought to our attention by Curt Chan and written by Tim Palucka - ANSYS - [Repairing Bone Loss with Simulation-Generated, Patient-Specific Implants](#)

When a person loses bone structure due to an accident or a disease, it's important for a surgeon to be able to reconstruct the lost bone as quickly as possible. quality of life of the patient.



Stephen Anchong Liu – Ozen

[Twin Builder](#) provides unmatched capabilities for system level design and validation. Twin Builder includes all of the capabilities that were part of the ANSYS Simplorer.



[B-52 bomber preparing to fly into 2050](#)

Collins Aerospace has supplied the B-52's engine system components since the 1950s

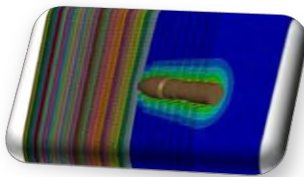

[LSDYNA-EM : Projectile penetration in battery pack](#)

The projectile is modelled as rigid. It penetrates several battery cells, causing deformation and failure. This erosion creates an internal short which in turn will generate a local heating.

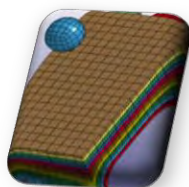

P. L'Eplattenier - [A Path Towards Including Batteries in Electric or Hybrid Car Crash Simulations with LS-DYNA®](#)

Shanghai Hengstar & Enhu Technology sells and supports LST's suite of products and other software solutions. These provide the Chinese automotive industry a simulation environment designed and ready multidisciplinary engineering needs, and provide a CAD/CAE/CAM service platform to enhance and optimize the product design and therefore the product quality and manufacture.

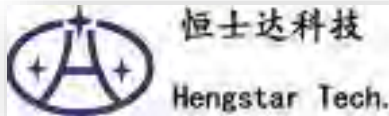

## Online workshop of SPH theory and applications in LS-DYNA®

Shanghai Hengstar Technology & Ansys/Lst will jointly organize a Web training of SPH theory and applications in LS-DYNA® on Jan 22 2021.

### Contents:

- History, Smoothing function (kernel), Variable Smoothing Length, Different SPH formulations.
- SPH Discretization of Continuum/Balance Equations, Total and updated Lagrangian.
- SPH thermal formulations, Thermomechanical coupling options between SPH and solids.
- Tension instability, Lagrangian and Eulerian kernel Functions, Renormalization and Consistency.
- Coupling with solids and its application in fluids.
- General features and applications (solid and fluid), keywords and use of SPH.
- Boundary conditions, Contacts, SPH/Lagrangian coupling, Thermal options, Coupling between SPH parts and between SPH and other particle methods (e.g. DEM, SPG and Peridynamics).
- Details of an Example: Control cards, Material, Sections, Parts, Outputs.

### Instructor:

**Jingxiao Xu Ph.D. Senior R&D Engineer (ANSYS / LST)**

Dr. Jingxiao got his Ph.D. degree of Mechanical Engineering from Northwestern University in 2004 then joined LST of ANSYS. He has been working on the meshfree methods and their applications since the day he joined LST. Currently he is developing and maintaining the code of the smoothed particle hydrodynamics (SPH) of LS-DYNA® and its' applications on high velocity impact, high explosive detonation, forging and extrusion, welding, bird strike testing, fluid, fluid-structure interaction, heat transfer, thermal-structure coupling, crack propagation and so on.

**Duration and Style:** (3 hours web training)

**Time:** Jan 22 2021 (9:00AM-12:00AM)

**Language:** Mandarin

**Contact:** Xixi Fei

Tell: 021-61630122 mobile:13524954631

Email: [Training@hengstar.com](mailto:Training@hengstar.com)

Shanghai Hengstar Technology Co., Ltd

[hongsheng@hengstar.com](mailto:hongsheng@hengstar.com)

<http://www.hengstar.com>

Shanghai Enhu Technology Co., Ltd

<http://www.enhu.com>

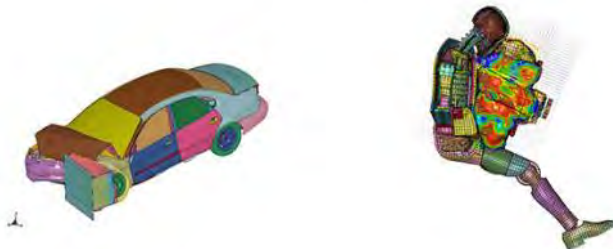

JSOL supports industries with the simulation technology of state-of-the-art. Supporting customers with providing a variety of solutions from software development to technical support, consulting, in CAE (Computer Aided Engineering) field. Sales, Support, Training.

### Accurate airbag deployment simulation

#### Airbag-folding simulation system for LS-DYNA

Airbag folding

## JFOLD<sup>®</sup>

- Easy, user-friendly, interactive tool setting
- Preview for checking tool performance
- Manage complicated folding process using a flowchart
- Save calculation results and patterns periodically
- Sewing simulation for 3D airbag



## JFOLD Features

### Towards more accurate airbag deployment simulation

JFOLD was developed to fold airbags for automotive crash simulation. JFOLD can be used to generate a folded airbag model using LS-DYNA simulation, regardless of the complexity of the geometry.

Airbags are one of the important safety devices for protecting the occupant during an accident: airbags are folded compactly and stored in the interior. The deployment behavior of an airbag depends on the pattern through which it is folded. The risk of occupant injury during airbag deployment, the out-of-position problem, considerably affects the occupant's safety performance.



Recently, the demand for more accurate airbag deployment simulation to improve the occupant's safety has been increasing. Building a folded airbag model with complicated geometry was an issue for CAE engineers to address.

JFOLD can manage the complicated folding process of an airbag using a flowchart in an easy-to-understand tree view. Users can build, manage, and view the airbag models in various folding patterns. The intuitive and interactive GUI facilitates the operation of defining the position and behavior of the folding tools.

KAIZENAT Technologies Pvt Ltd is the leading solution provider for complex engineering applications and is founded on Feb 2012 by Dr. Ramesh Venkatesan, who carries 19 years of LS-DYNA expertise. KAIZENAT sells, supports, trains LS-DYNA customers in India. We currently have office in Bangalore, Chennai, Pune and Coimbatore.



## Kaizen-DYNA App

- "Kaizen-DYNA" is a mobile and web based application which is built by Kaizenat Technologies Private Limited (KTPL) to help LS-DYNA users across the world.
- This powerful application helps LS-DYNA users across the world to stay connected and also help each other by sharing their knowledge.
- The key feature of this application is QUERY and RESPONSE. Where a user can post and respond to queries. The best response for each query will be rewarded with a Kaizen score.
- This application also gives an opportunity for the employers to float their LS-DYNA job openings and alert its user's base with a notification.
- "Kaizen-DYNA" quiz program can help LS-DYNA users to update their knowledge score and trend top in the job seekers list.
- It also gives an opportunity for new users to learn LS-DYNA with training materials FAQ modules.
- This application also brings latest news about LS-DYNA and some useful general information.



Android App



iPhone App



Web App

### Contact

Email : [support@kaizenat.com](mailto:support@kaizenat.com) Phone: +91 80 41500008

**Contact:** Email : [support@kaizenat.com](mailto:support@kaizenat.com) Phone: +91 80 41500008

A team of engineers, mathematicians, & computer scientists develop LS-DYNA, LS-PrePost, LS-OPT, LS-TaSC, and Dummy & Barrier models, Tire models.

## On Setting up a Structured ALE Model

*Hao Chen, Ansys*

LS-DYNA ALE has been widely used to simulating moving fluids interacting with structures. Unlike CFD, the focus is rather on the structure response under dynamic loading from fluids, than the fluids' motion. Fluids are agitated by a high pressure gradient; and then hit the structure, carrying a large momentum. The key in successfully capturing the physics lies in the fluid-structure interaction algorithm. It needs to accurately predict the peak of pressure loading during the impact, which is characterized as a momentum transfer process. This request could only be fulfilled by a transient analysis with a penalty-based coupling between fluids and structure.

In 2015, LSTC introduced a new structured ALE (S-ALE) solver option dedicated to solve the subset of ALE problems where a structured mesh is appropriate. As expected, recognizing the logical regularity of the mesh brought a reduced simulation time for the case of identical structured and unstructured mesh definitions. It also comes with a cleaner, conceptually simpler way of model setup. This article gives a brief description of the S-ALE model setup.

### **PART is the problem.**

This section is to give a background information on the introduction of a new keyword `*ALE_STRUCTURED_MULTI-MATERIAL_GROUP`. For new users never used previous ALE/S-ALE setup, please skip this section as it is irrelevant and could be confusing without knowing some history of changes in ALE setups.

“Part” definition is conveniently used in Finite element models to link the material definition and mesh of a Lagrange structure. A typically “PART” definition contains three things: SECTION, which is the integration rule; MAT+EOS, the material property; and mesh, linked by the PARTID and listed under \*ELEMENT keyword. In a Lagrange simulation, “PART” has dual meanings – it refers to both the mesh and the material.

In the world of ALE, it is a little more complicated. As we are dealing with fluids, our point of view is rather Eulerian, not Lagrangian. This means the mesh and materials are not; and should not be bundled together. Mesh is no longer a spatial representation of material; and its boundary surface is no long material interface. Rather, the mesh, in an ALE simulation, is simply a spatial domain, to provide room for the fluids to occupy and flow. They are multiple fluids inside this mesh and associate this mesh with any one material property does not make any sense.

The general ALE solver borrowed “PART” definition. This caused quite some confusion in our users, even the most experienced users. It is not surprising at all, as sometimes “PART” refers the mesh; other times the material; and on several occasions, it refers to both mesh and materials.

When constructing the Structured ALE keywords, the author tried to separate this dual meanings “PART” definition into two distinguished definitions – “Mesh Part” and “Material Part”. It helped to some extent, but still considerable confusion still exists. As S-ALE solver is gradually picking up more usage, it becomes mandate to address this issue once and for all. Streamlining the S-ALE setup would save a lot of users’ effort, especially for our new users not familiar with LS-DYNA keyword setups.

A new keyword, \*ALE\_STRUCTURED\_MULTI-MATERIAL\_GROUP was introduced recently. It is available in the latest beta version executable and will be in the next R12.1 release. This keyword no longer uses “PART” to link the material properties and hence eliminates the concept of “Material Part”. The author believes it would prevent most common user setup mistakes.

**Three step setup**

We follow a straight-forward three step setup. First, mesh; secondly, material properties of fluids; thirdly, filling the mesh with fluids. In this section, we describe the three keywords doing these three steps.

1. Mesh generation: \*ALE\_STRUCTURED\_MESH;  
\*ALE\_STRUCTURED\_MESH\_CONTROL\_POINTS

In S-ALE, mesh is always rectangular. Obviously an automatically generated mesh would get rid of lots of unnecessary hassles in the model building and execution. So that was the route we took. To determine the mesh layout in the space, we need the following information:

- a. The mesh spacing along three axes (LCIDX,LCIDY,LCIDZ).
- b. The origin (NID0), and local coordinate system (LCSID).

Other fields are for identification purpose only and are self-explanatory. MSHID stands for mesh ID; DPID Part ID; NBID and EBID are the IDs of first S-ALE mesh node and element, respectively. TDEATH is to the “death time” for S-ALE mesh. It is to turn off the S-ALE calculation once the most of fluid loading is applied; and keep the Lagrange model running as the structure deformation is not fully developed yet.

*ALE_STRUCTURED_MESH							
MSHID	DPID	NBID	EBID				TDEATH
CPIDX	CPIDY	CPIDZ	NID0	LCSID			

The LCIDX, LCIDY and LCIDZ are IDs of \*ALE\_STRUCTURED\_MESH\_CONTROL\_POINTS cards. Each card specifies the mesh spacing along one axis.

*ALE_STRUCTURED_MESH_CONTROL_POINTS							
CPID							
N1		X1		RATIO1			
...		...		...			
Nn		Xn		RATIO <sub>n</sub>			

The idea of the “\_CONTROL\_POINTS” card is simple. Let us forget about the “RATIO” field which is for progressive mesh spacing. This card contains some number of (N,X) pairs. And each (N,X) pair means “the Nth node’s coordinate is X”. Between any two consecutive (N,X) pairs mesh is evenly distributed. Take the simplest case, say 10 elements between [0,1]. A simple two pairs setup of (1,0.) and (11,1.) is sufficient. To another extreme, say we really want some insane irregular mesh. We could make 11 pairs of (N,X) like (1,0.), (2,0.07), (3,0.13), (4,0.2), (5,0.26), (6,0.37), (7,0.47), (8,0.53), (9,0.79), (10,0.8), and finally (11,1.).

The progressive mesh spacing is something worth a separate article by itself and hence skipped in this introductory paper. It is powerful but conceptually not so user-friendly. Efforts are being continuously made to improve this part. Please stay tuned for the updates.

2. Material definitions: \*ALE\_STRUCTURED\_MULTI-MATERIAL\_GROUP

S-ALE mesh is simply a spatial domain in which fluids flow. In order to let the code know what and how many fluids there are, we need to provide material properties of each fluid and list them all under the card \*ALE\_STRUCTURED\_MULTI-MATERIAL\_GROUP. Please note, AMMG stands for ALE multi-material group, a rather alternative and maybe confusing name for “ALE fluid”. In this paper we are going to use AMMG and fluid interchangeably.

*ALE_STRUCTURED_MULTI-MATERIAL_GROUP							
AMMGNM1	MID1	EOSID1					PREF1
...	...	...					...
AMMGNMn	MIDn	EOSIDn					PREFn

“AMMGNM” is a name one gives to a AMMG (ALE Multi-Material Group), aka ALE fluid. It is used in other cards, for example, \*SET\_MULTI-MATERIAL\_GROUP\_LIST to refer to that AMMG. “MID” and “EOSID” are the material ID and EOS ID, respectively.

“PREF” is to describe the reference pressure or “base pressure” of that fluid. This might be somewhat new to our typical users from solids background. Pressure of a solid material, if not preloaded, always starts from zero. In such case, its reference pressure or base pressure, is zero. But most fluids have non-zero reference pressure. For example, air has a base pressure of 101325 Pa (1 bar atmospheric pressure). Traditionally this reference pressure is prescribed using the field “PREF” in \*CONTROL\_ALE card. The new \*ALE\_STRUCTURED\_MULTI-MATERIAL\_GROUP has a design to allow each AMMG to have its own reference pressure. The author believes this added flexibility could be proven very useful in certain applications.

3. Volume Filling: \*ALE\_STRUCTURED\_MESH\_VOLUME\_FILLING

Now we have a rectilinear S-ALE mesh, which is our calculation domain. And we have several fluids which resides in this domain. Before carrying out our simulation, there is still one critical information missing. That is: how are those fluids occupying the domain? This information is given as the form

of volume fraction per element. Basically we need to assign the volume fraction for each AMMG (ALE fluid) for each element. Say one element is fully occupied by AMMG “water”, then the volume fraction of that element is (1, 0, 0), assuming the ALE materials are (“water”, “air”, “vacuum”). Similarly (0.6,0.3,0.1) if “water” 60%, air 30% and vacuum 10%. For each element, the code needs to know the volume fraction of all ALE fluids.

The first way is to explicitly list volume fractions for each element. This could be done through a keyword card called “\*INITIAL\_VOLUME\_FRACTION”. This approach is seldomly used as first, it is tedious and secondly, too much burden on users.

The much easier solution is to automatically generate the volume fraction information based on certain user supplied geometries. These geometries could be simple shapes like sphere, plane, box, cylinder. Or it could be user-defined complex shape like structure surfaces. With certain geometric shape defined, users could then fill the inside or outside of that shape with certain ALE fluid. The volume fractions are internally calculated, stored and then used in the subsequent simulation to reconstruct the fluid interface.

This is done by using the keyword “\*ALE\_STRUCTURED\_MESH\_VOLUME\_FILLING”. The “volume filling” process typically is done through multiple “tasks”, each task by a separate keyword.

*ALE_STRUCTURED_MESH_VOLUME_FILLING							
MSHID		AMMGTO		NSAMPLE			VID
GEOM	IN/OUT	E1	E2	E3	E4		

MSHID is the S-ALE mesh ID, defined in \*ALE\_STRUCTURED\_MESH card. And AMMGTO is the name of ALE fluid to be filled, defined in \*ALE\_STRUCTURED\_MULTI-MATERIAL\_GROUP. VID is to prescribe the initial velocity of that fluid, if any. And NSAMPLE is default to 3 which means that one ALE cell is divided into 7x7x7 (7=2\*3+1) sub-cells and each sub-cell is checked to see if it is inside/outside.

It supports 5 basic geometries: Plane, Cylinder, Ellipsoid, Box with indices and Box with coordinates. And E1-E4 are used to provide information of these geometries. For complicated geometries, we need users to provide us with a segment set (or something we could internally convert to a segment set). The assumption is that all segment normals are consistent; and those normals point to the “inside”. For convenience, we provide a “IN/OUT” flag for an easier flip.

## A Simple Example

Now let us use a simple example to illustrate this 3-step process. It is to model a long rod projectile impacting an oblique steel plate (Fugelso & Taylor 1978). The dimensions were from ARL-TR-2173 (Schraml & Kimsey 2000) and material properties from “Numerical Simulation of High-Velocity oblique Impacts of Yawed Long Rod Projectile Against Thin-Plate” (Yo-Han Yoo 2002).



Below is a sketch showing a projectile at 1289m/s and hitting a plate which is moving up at 217 m/s. Projectile has a length of 76.7mm and a diameter of 7.67mm. Plate has a thickness of 6.4 mm, a width of 60mm and a length of 150mm. The unit used is mm-g-s.

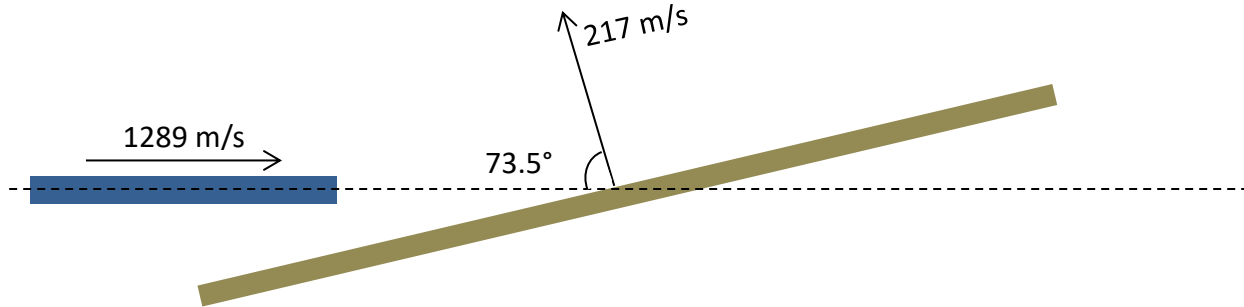

Step 1: To construct a mesh spans (-107.5,-30,-15) to (107.5,30,15) with 215x60x30 elements.

```
*ALE_STRUCTURED_MESH
$  mshid      pid      nbid      ebid
$    1         11      100001    100001
$  cpidx      cpidy     cpidz     nid0     lcsid
$    1001      1002      1003

*ALE_STRUCTURED_MESH_CONTROL_POINTS
$  cpid
$    1001
$
$          N          X
$          1          -107.5000
$          216         107.5000

*ALE_STRUCTURED_MESH_CONTROL_POINTS
$  cpid
$    1002
$
$          N          X
$          1          -30.000
$          61         30.000

*ALE_STRUCTURED_MESH_CONTROL_POINTS
$  cpid
$    1003
$
$          N          X
$          1          -15.0000
$          31         15.0000
```

Step 2: Set up ALE multi-material Groups (AMMGs or ALE fluids). There are totally 3 AMMGs defined. First is “Rod” by \*MAT\_JOHNSON\_COOK (MID=1) and \*EOS\_LINEAR\_POLYNOMIAL (EOSID=1). Next is “Vacuum” by \*MAT\_VACUUM (MID=3). The third is “Plate” by \*MAT\_JOHNSON\_COOK (MID=2) and \*EOS\_LINEAR\_POLYNOMIAL (EOSID=2). Their materials properties are given as follows.

```
*MAT_JOHNSON_COOK
$  MID      RO      G      E      PR      DTF      VP      RATEOP
$    1      18.6e-3  63.692e3  165.6e3  0.3
```

```

$      A      B      N      C      M      TM      TR      EPS0
1.079e3  1.12e3  0.25  0.0070  1.0  1473  283  1.0e-3
$      CP      PC      SPALL      IT      D1      D2      D3      D4
130.0
$      D5      C2/P      EROD      EFMIN      NUMINT

```

\*EOS\_LINEAR\_POLYNOMIAL

```

$      eosid      c0      c1      c2      c3      c4      c5      c6
1      0.000  138.00e3
$      e0      v0
0.000  0.000

```

\*MAT\_JOHNSON\_COOK

```

$      MID      RO      G      E      PR      DTF      VP      RATEOP
2      7.87e-3  76.692e3  200.1e3  0.3
$      A      B      N      C      M      TM      TR      EPS0
0.792e3  0.510e3  0.26  0.0140  1.03  1809  283  1.0e-3
$      CP      PC      SPALL      IT      D1      D2      D3      D4
480.0
$      D5      C2/P      EROD      EFMIN      NUMINT

```

\*EOS\_LINEAR\_POLYNOMIAL

```

$      eosid      c0      c1      c2      c3      c4      c5      c6
2      0.000  166.75e3
$      e0      v0
0.000  0.000

```

\*MAT\_VACUUM

```

$      MID
3      1.0e-9

```

Now construct the ALE fluids by using \*ALE\_STRUCTURED\_MULTI-MATERIAL\_GROUP.

\*ALE\_STRUCTURED\_MULTI-MATERIAL\_GROUP

```

$      name      mid      eosid      pref
rod      1      1
vacuum   3
plate   2      2

```

Step 3: Volume Filling the initial S-ALE mesh. By

\*ALE\_STRUCTURED\_MESH\_VOLUME\_FILLING.

First, fill all with “vacuum”.

\*ALE\_STRUCTURED\_MESH\_VOLUME\_FILLING

```

$#      mshid      -      ammgto      -      nsample      -      -      vid
1      -      vacuum

```

```

$#      geom      in/out
ALL      0

```

Next, assign the inside of box (BOXID=1) to “plate”.

\*ALE\_STRUCTURED\_MESH\_VOLUME\_FILLING

```

$#      mshid      -      ammgto      -      nsample      -      -      vid
1      -      plate

```

```

$#      geom      in/out      boxid
BOXCOR      0      1

```

```
*DEFINE_BOX_LOCAL
$#   boxid      xmn      xmx      ymn      ymx      zmn      zmx
      1         0.0     150.0     0.0      6.4      0.0      30
$#   xx         yx         zx         xv         yv         zv
      0.95882   0.28402     0.0    -0.28402   0.95882     0.0
$#   cx         cy         cz
      -71.0026  -24.3694     -15.0
```

Finally, assign the inside of a cylinder to “rod”.

```
*ALE_STRUCTURED_MESH_VOLUME_FILLING
$#   mshid      -      ammgto      -      nsample      -      -      vid
      1         rod
$#   geom      in/out      nid1      nid2      radii1      radii2
CYLINDER      0         1         2         3.835      3.835
*NODE
$#   nid      x      y      z      tc      rc
      1      -103.0     0.0     0.0     0     0
      2      -26.33     0.0     0.0     0     0
```

And the initial velocities of “plate” and “rod” are prescribed by using the following cards.

```
*DEFINE_VECTOR
$#   vid      xt      yt      zt      xh      yh      zh      cid
      1     -61.631    208.06     0.0     0.0     0.0     0.0     0
      2     1289.0     0.0     0.0     0.0     0.0     0.0     0
```

That is all! But before we could make it run, we need to add in some more control card and database cards. We could use \*CONTROL\_ALE to make a choice of order of accuracy, 1<sup>st</sup> order (donor cell) or 2<sup>nd</sup> order (van Leer).

```
*CONTROL_ALE
$#   dct      nadv      meth      afac      bfac      cfac      dfac      efac
      1
$#   start      end      aafac      vfact      prit      ebc      pref      nsidebc
```

The rest of fields should be left as blank most of the time, if not all. They are used in generic ALE solvers but mostly ignored in S-ALE solvers with only a few exceptions.

And other cards:

```
*CONTROL_TERMINATION
$#   endtim      endcyc      dtmin      endeng      endmas
      0.0800000
*CONTROL_TIMESTEP
$#   dtinit      tssfacc      isdo      tslimt      dt2ms      lctm      erode      mslst
      0.000      0.600000
$#   dt2msf      dt2mslc      imsc1
      0.000      0         0
*DATABASE_BINARY_D3PLOT
$#   dt      lcdt      beam      npltc      psetid
      0.001000
```

Now run it with 16 core MPP executable. It will only take 39 seconds. Please note as not all S-ALE keywords are finalized until recently (Jan 2021), we need to use the latest DEV version of LS-DYNA. R12.1 version should be available in the first half of year 2021.

Below is the projectile and plate at  $t=0$ .,  $t=0.04\text{ms}$  and  $t=0.08\text{ms}$ . The input deck is available at [https://ftp.lstc.com/anonymous/outgoing/hao/sale/models\\_R121/cthrod.k](https://ftp.lstc.com/anonymous/outgoing/hao/sale/models_R121/cthrod.k)

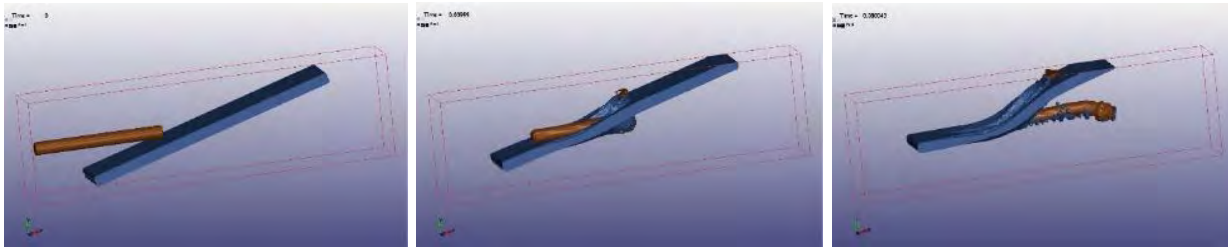

## Ending Remarks

LS-DYNA ALE module has been known for its steep learning curve. Partially it was because setting up Eulerian models are intrinsically different from Lagrange models. But the design of ALE keyword cards, for sure, has caused quite a lot of confusions among our users, new and experienced.

To prompt LS-DYNA ALE usages, Structured ALE solver introduced a new, user-friendly, streamlined three-step setup. We hope this effort could help users, new or old, to perform their work more efficiently and smoothly.

## LS-PrePost® an Advanced Pre- and Post-processor

LS-PrePost® is an advanced pre- and post-processor developed for LS-DYNA®. It is fully multi-platform with support for Windows, Linux and Mac OSX. LS-PrePost is based on the OpenGL rendering engine with a design that is both efficient and intuitive. It is delivered with LS-DYNA without additional cost and may be installed on multiple platforms. License keys are

### Geometry and Meshing Includes

- A geometry engine which allows the creation and modification of curves, surfaces, and solid objects. Also included are tools to heal and simplify the geometry model
- An automatic surface meshing tool
- An automatic 3-Dimension(3D) tetrahedron meshing module
- Various methods to create a mesh by dragging, spinning, offsetting, and sweeping
- The construction of middle surface shells from 3D Solids

### Pre- and Post-Processing Capabilities

- Complete LS-DYNA Keyword management
- Tools to create and modify LS-DYNA entities
- General model setup for NVH (Noise, Vibration and Harshness), Implicit, and Thermal Analyses
- Tools to measure FEA data like distance, area, angle, volume, mass, etc.
- Section cuts for better visualization in complicated models
- Comprehensive time history plotting for the d3plot, ASCII history, and BINOUT databases
- Time history plotting for user defined data
- Particle elements (SPH, CPM, DES, SPG) visualization
- CFD models and results visualization

### Other General Functions

- Tools to display, reverse, and auto reverse the normal vector directions of Shells, Segments, Thick Shells, and Cohesive Elements
- Printing of High Definition pictures in a choice of formats
- Movie creation for animation sequences
- Commands, Macros and a Scripting Command Language (SCL) with C /Python API for automated Pre- and Post-Processing

### Applications

- Airbag folding
- Comprehensive model checking including contact initial penetration check
- Dummy positioning
- Metal forming process setup
- Seatbelt fitting

### LS-PrePost Pre- and Post-Processing

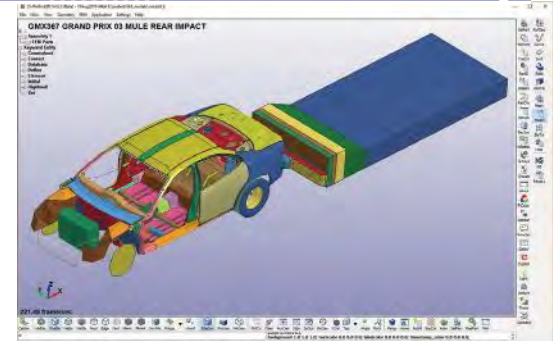

### LS-DYNA Geometry and Meshing

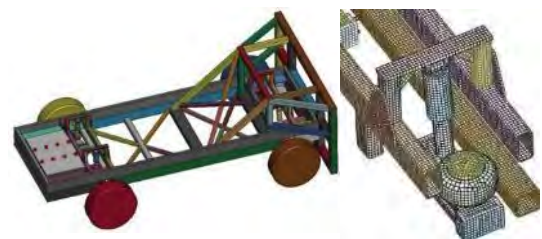

### ICFD Post-Processing

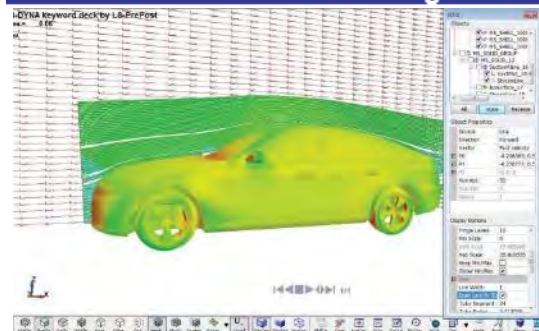

Providing engineering services to the composites industry since 1970. During this time, we have participated in numerous programs that demonstrate our ability to perform advanced composite design, analysis and testing; provide overall program management; work in a team environment; and transition new product development to the military and commercial sectors.



Bottom photos courtesy of TPI Composites, Inc. (left) and Seemann Composites, Inc. (right)

## Engineering Services

MSC brings a long-range perspective to its engineering services clients. We understand the history of our core technologies, and can project likely new developments, and seek to provide innovation. A keen appreciation of the materials and structures state-of-the-art gives us the ability to create a development roadmap that efficiently reaches the clients goal, while taking full advantage of what already exists. We have an unusually broad exposure to materials applications; we have been involved with everything from infrastructure applications to spacecraft. This broad perspective allows us to draw on approaches and trends in one application area, and apply it to another. This helps our clients avoid pitfalls, and make exceptionally rapid technological progress. The same broad reach allows us the opportunity to interact with, and evaluate a wide range of suppliers.

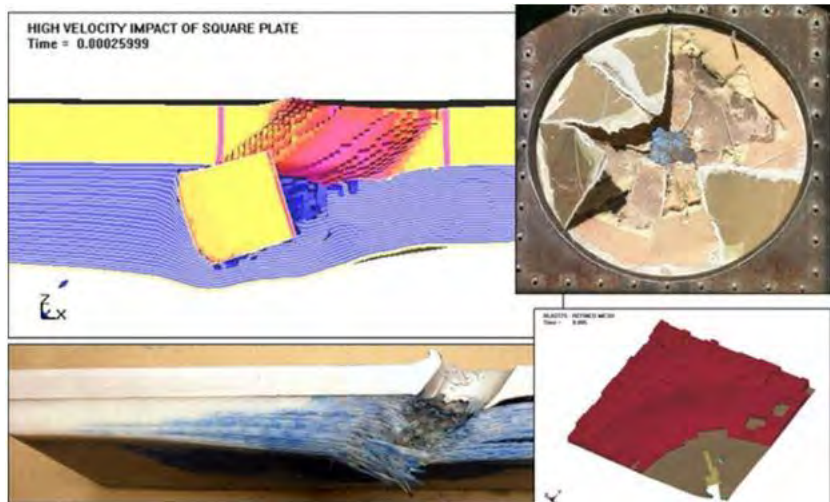

Oasys Ltd is the software house of Arup and distributor of the LS-DYNA software in the UK, India and China. We develop the Oasys Suite of pre- and post-processing software for use with LS-DYNA.

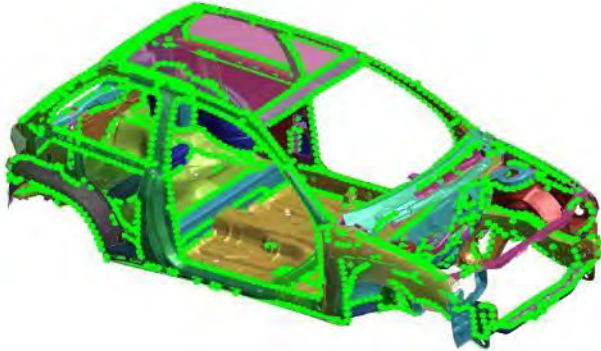

## Webinar Oasys PRIMER - Spotwelding and Connections 26<sup>th</sup> January 2021

Oasys PRIMER has extensive tools and functionality to create and manage connections in LS-DYNA models. This webinar provides an overview and demonstration of the process to create, modify and check spotweld connections.

[Register](#)

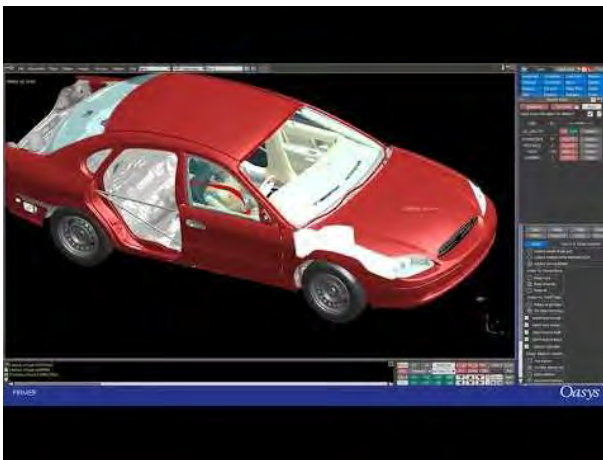

**Top Tip video:  
Did you know?**

Did you know that Oasys PRIMER has powerful tools to replace parts in one model with those from another? To view the video, click on the [image on the left](#).



## Oasys and LS-DYNA training courses 2021

The Oasys LS-DYNA training courses are now scheduled and available to view on our [website](#).

Please register your interest by completing the form on the relevant course page.  
If you have any additional queries, please reach out to [dyna.support@arup.com](mailto:dyna.support@arup.com)



## Oasys LS-DYNA Social Media Channels

We would like to invite you to join our Oasys LS-DYNA Environment Software LinkedIn Group and YouTube channels. On LinkedIn we share content with other Oasys LS-DYNA software users, from interesting simulations to information about our webinars and training courses.

Please join us by clicking on [YouTube](#) and [LinkedIn](#) images.



Predictive Engineering provides FEA and CFD consulting services, software, training and support to a broad range of companies



**Predictive Engineering – Western States  
ANSYS LS-DYNA Distributor – Your Free  
Coffee Cup is On Its Way!**

## **Fatigue Analysis: ASME Section VIII, Division 2, Part 5.5 Protection Against Failure from Cyclic Loading**

December, 2020 In:News, Blogs and Updates Posted By: George Laird

Even with an academic and experimental background in fatigue analysis, it is daunting to provide a hard, no-nonsense life-cycle prediction. It becomes especially daunting when your fatigue prediction can cost or save your client millions of dollars. Plus, there are tons of computer programs that promise “instant fatigue nirvana” at the press of a button; which leads one to ask: “What is a poor engineer supposed to do?” Over the years, we have learned that there are three critical components to a quality fatigue analysis: i.) accurate FEA stress results, ii.) accurate FEA stress results and iii.) accurate FEA stress results. Okay, sad, old, real-estate joke about location, location, and location; but let us just imagine that your stress numbers are good, then what? Fatigue analysis is all about the protection of structures and systems against failure from cyclic loading. This is where the ASME Boiler & Pressure Vessel Code (BPVC) provides a tried and true standard that, if your stress numbers are good, then you can be assured that your fatigue prediction will be conservative. Besides providing robust fatigue curves, the Code provides explicit guidance on how to treat welds based on type, inspection and surface quality. For example, if the weld is completely un-inspected and un-finished, then it earns a fatigue-strength-reduction factor or 4x, which means your FEA stress numbers are multiplied by 4x prior to the calculation of fatigue cycles per the ASME curve. In contrast, if a full penetration weld is ground to smooth profile and then fully-inspected (volumetric and surface examinations), then the fatigue-strength-reduction factor is 1x. The ASME code makes clear that it is not saying that the weld material is as good as the base material, but merely that the ASME fatigue curves are still accurate. The ASME fatigue method was recently used to confirm cyclic fatigue damage and to guide subsequent design revisions. From an engineer’s perspective, it was a very satisfying journey since the Code provided clear guidance on how to treat welded and non-welded sections. The projects have been completed and now we wait to see what happens. Nothing is perfect and one never truly knows with fatigue, but at least following the ASME “Protection Against Failure from Cyclic Loading” we are not flying alone.

Hydroelectric Facilities: Large Rotating Equipment

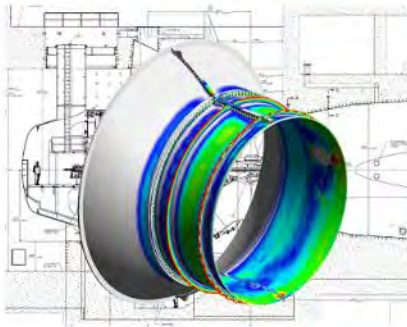

Twin-Screw Augers: Large Rotating Equipment

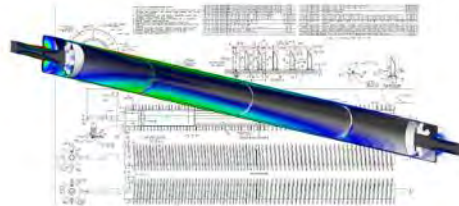

ASME Section VIII, Div. 2, Part 5.5.3 Fatigue Assessment

Table 5.11 – Weld Surface Fatigue-Strength-Reduction Factors

Weld Condition	Surface Condition	Quality Levels (see Table 5.12)						
		1	2	3	4	5	6	7
Full penetration	Machined	1.0	1.5	1.5	2.0	2.5	3.0	4.0
	As-welded	1.2	1.6	1.7	2.0	2.5	3.0	4.0
Partial Penetration	Final Surface Machined	NA	1.5	1.5	2.0	2.5	3.0	4.0
	Final Surface As-welded	NA	1.6	1.7	2.0	2.5	3.0	4.0
	Root	NA	1.5	NA	NA	NA	3.0	4.0
Fillet	Toe machined	NA	NA	1.5	NA	2.5	3.0	4.0
	Toe as-welded	NA	NA	1.7	NA	2.5	3.0	4.0
	Root	NA	NA	NA	NA	NA	3.0	4.0

View the portfolio: [FEA, CFD and LS-DYNA consulting projects](#)

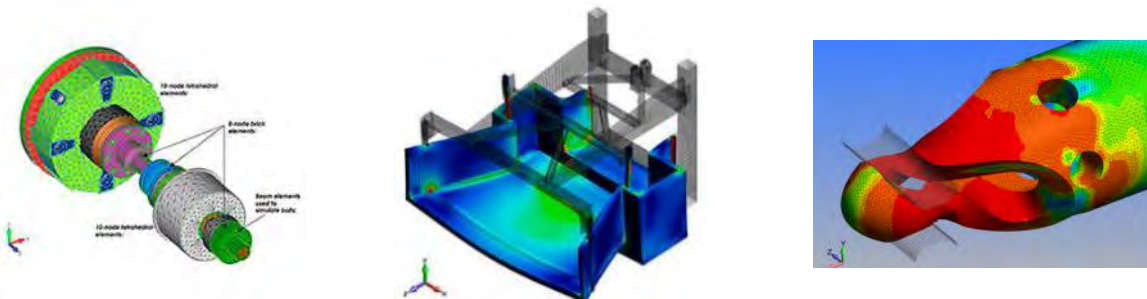

## Contact:

**Address:**  
2512 SE 25th Ave  
Suite 205  
Portland, Oregon 97202  
USA

**Phone:**  
503-206-5571  
**Fax:** 866-215-1220  
**E-mail:**  
[sales@predictiveengineering.com](mailto:sales@predictiveengineering.com)

Offering industry-leading software platforms and hardware infrastructure for companies to perform scientific and engineering simulations. Providing simulation platforms that empower engineers, scientists, developers, and CIO and IT professionals to design innovative products, develop robust applications, and transform IT into unified, agile environments.



## Rescale Named to Y Combinator's Top Companies List

January 14, 2021, Jolie Hales  
Aerospace, Announcements, Automotive, Engineering, English, Life Science

**SAN FRANCISCO, January 14, 2021** — [Rescale](#), the leading hybrid HPC cloud platform enabling intelligent computing for digital R&D, was recently named to [Y Combinator's Top Companies list](#), reaffirming their position as a power player among startups.

“We’re honored to be recognized by Y Combinator on their Top Companies list for the third year in a row,” said Joris Poort, Founder and CEO of Rescale. “2020 was an unprecedented year of unexpected challenges for all, and I’m proud of our team’s resiliency to help our customers continue to push innovation to new frontiers, ultimately helping our business thrive and earning us a coveted spot listed alongside some of the most transformational and disruptive startups in the world.”

Founded in 2011 and backed by investors like Jeff Bezos, Richard Brandson, Peter Thiel, and Microsoft, Rescale is accelerating cloud adoption for the science and engineering community, powering breakthroughs for more than 200 customers in industries from aerospace to life sciences to automotive and beyond. In 2020, the number of jobs submitted on Rescale doubled, as well as the number of software applications available on the platform.

Listed and ranked by valuation, Rescale joins other Y Combinator alumni like Airbnb, DoorDash, Stripe, and Reddit on the Top Companies list. Combined, the 134 companies on this year’s list are valued at over \$300 billion, with more than 125 of them valued at more than \$150 million. The listed companies combined are responsible for creating more than 60-thousand jobs.

Y Combinator is the largest startup accelerator in the world, investing in a large number of startups every year, and then working with those companies to get them into the best shape possible to pitch to investors. Rescale completed the program in 2012.

The Top Companies list selects from the [more than 2,000 companies](#) they’ve worked with since 2005. This year marks the third time Y Combinator has published the Top Companies list.

### About Rescale:

Rescale (@rescaleinc) is the leading hybrid HPC cloud platform for the scientific research and development community helping more than 200 customers from startups to Fortune 50 enterprises accelerate design cycles and time to market. Founded by former Boeing aerospace engineers, Rescale gives research scientists and engineers the ability to run their simulation and artificial intelligence workloads on the cloud provider of their choice, using specialized hardware architectures and software templates optimized for their use cases, without any set-up or maintenance. Rescale’s HPC cloud infrastructure is the engine accelerating product research and development cycles across many of today’s most exciting scientific use cases.

**Contact:** Jolie Hales [jolie@rescale.com](mailto:jolie@rescale.com)  
[Rescale, Inc.](#)

LS-DYNA China, as the master distributor in China authorized by LST, an Ansys company, is fully responsible for the sales, marketing, technical support and engineering consulting services of LS-DYNA in China.



**仿坤软件**  
LS-DYNA China

**Shanghai Fangkun Software Technology Ltd**

Shanghai Fangkun Software Technology Ltd. was authorized by ANSYS Inc as the domestic master distributor of LS-DYNA software. Shanghai Fangkun is fully responsible for domestic sales, marketing, technical support of LS-DYNA. By integrating and managing a wide range of resources such as LS-DYNA agents and partners, Shanghai Fangkun is focus on providing a strong technical support for domestic LS-DYNA users, and help customers to effectively use LS-DYNA software for product design and development.

Based on the strong technical support and developing capability from ANSYS Inc, Shanghai Fangkun attracts a group of top LS-DYNA application engineers and commit to provide LS-DYNA technical support in the automotive industry, electronics industry, rock-soil, aerospace, general machinery and other industries. Shanghai Fangkun devotes to providing all products of LSTC including LS-DYNA, LS-OPT, LS-PREPOST, LS-TASC and LSTC FEA models (dummies model, pedestrian model, etc).

In the meantime, Shanghai Fangkun also relies on strong technical support of ANSYS Inc and will focus on secondary development and process customization of LS-DYNA and its application process. In view of domestic users customization requirement, Shanghai Fangkun will concentrate on customizing custom interface based on LS-PREPOST processing platform, to adjust, standardize and analyzes specific process, improve the efficiency in application, reduce human error, accumulate experience of engineering application, improve customer R&D and competition capabilities.

Shanghai Fangkun will keep mission firmly in mind, devote to improving user satisfaction of LS-DYNA and providing high-quality technical support and engineering consulting services for users.

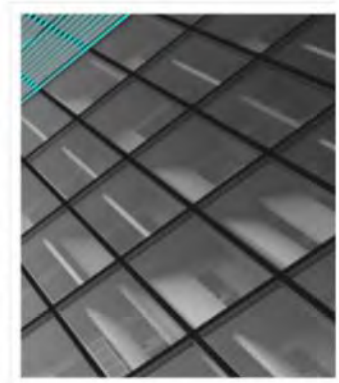
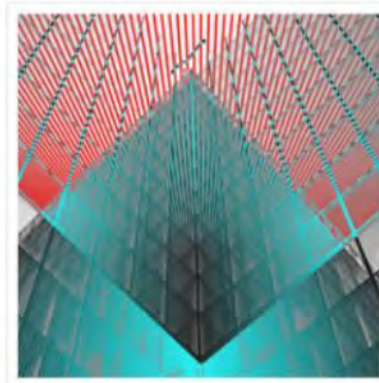
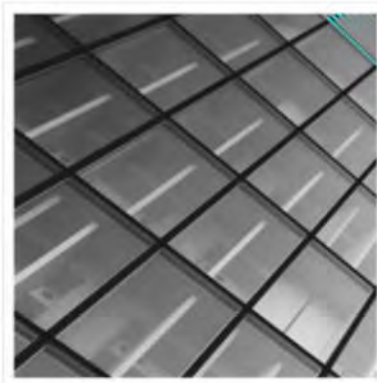

## Contacts

**Address:** Room 2219, Building No.1, Global Creative Center, Lane 166, Minhong Road, Minhang District, Shanghai

**Postcode:** 201102 Tel: 4008533856 021-61261195

**Sales Email:** sales@lsdyna-china.com Technical Support Email: support@lsdyna-china.com



## LS-DYNA Training Plan in 2021

Shanghai Fangkun has successfully held several series of LS-DYNA related webinars and training courses in 2020 and received much attention and feedback. Now Shanghai Fangkun release the training plan for 2021 as shown in the following table. Please follow us official Wechat “LSDYNA” to get latest information. All LS-DYNA users and those who interested in are welcome to attend. If you have any questions, please contact email [training@lsdyna-China.com](mailto:training@lsdyna-China.com), or dial 021-61261195, 4008533856.

Date	Topic	Duration
Jan.	LS-DYNA Basic Training	2 days
Feb.	Introduction to LS-PrePost	4-8 hours
Feb.	Introduction to LS-Form & Stamp forming	4-8 hours
Mar	Crash & Safety analysis in LS-DYNA	2 days
Mar	Introduction to LS-Form & Stamp forming	4-8 hours
Apr	GISSMO failure model theory and application of LS-DYNA	4-8 hours
Apr	Simulation of battery crush and nail penetration in multiphysical field with LS-DYNA	4-8 hours
May	Concrete material model in LS-DYNA	2-4 hours
May	Introduction to S-ALE	4-8 hours
Jun	Drop analysis in LS-DYNA	4-8 hours
Jun	Introduction to Contact in LS-DYNA	4-8 hours
Jul	Introduction to EM in LS-DYNA	4-8 hours
Jul	Introduction to LS-OPT	4-8 hours
Aug	ICFD analysis in LS-DYNA	2-4 hours
Aug	LS-DYNA Basic Training	4-8 hours
Sep	Implicit analysis in LS-DYNA	4-8 hours
Sep	CESE analysis in LS-DYNA	2-4 hours
Oct	LS-DYNA application in constranit system	4-8 hours
Oct	Meshfree,SPG and Advanced finite element analysis in LS-DYNA	4-8 hours
Nov	LS-DYNA composite material model training	4-8 hours
Nov	LS-DYNA Thermal-structural-Coupling Analysis	4-8 hours
Dec	LS-DYNA Welding Analysis	4-8 hours
Dec	NVH, Frequency domain and fatigue in LS-DYNA	4-8 hours

Shanghai Fangkun Software Technology Ltd. was authorized by ANSYS Inc as the domestic master distributor of LS-DYNA software and will keep mission firmly in mind, devote to improving user satisfaction of LS-DYNA and providing high-quality technical support and engineering consulting services for users.

CAE software sale & customer support, initial launch-up support, periodic on-site support. Engineering Services. Timely solutions, rapid problem set up, expert analysis, material property test Tension test, compression test, high-speed tension test and viscoelasticity test for plastic, rubber or foam materials. We verify the material property by LS-DYNA calculations before delivery.



**CAE consulting** - Software selection, CAE software sale & customer support, initial launch-up support, periodic on-site support.

**Engineering Services** - Timely solutions, rapid problem set up, expert analysis - all with our Engineering Services. Terrabyte can provide you with a complete solution to your problem; can provide

you all the tools for you to obtain the solution, or offer any intermediate level of support and software.

## FE analysis

- LS-DYNA is a general-purpose FE program capable of simulating complex real world problems. It is used by the automobile, aerospace, construction, military, manufacturing and bioengineering industries.
- ACS SASSI is a state-of-the-art highly specialized finite element computer code for performing 3D nonlinear soil-structure interaction analyses for shallow, embedded, deeply embedded and buried structures under coherent and incoherent earthquake ground motions.

## CFD analysis

- AMI CFD software calculates aerodynamics, hydrodynamics, propulsion and aero elasticity which covers from concept design stage of aircraft to detailed design, test flight and accident analysis.

## EM analysis

- JMAG is a comprehensive software suite for electromechanical equipment design and development. Powerful simulation and analysis

technologies provide a new standard in performance and quality for product design.

## Metal sheet

- JSTAMP is an integrated forming simulation system for virtual tool shop based on IT environment. JSTAMP is widely used in many companies, mainly automobile companies and suppliers, electronics, and steel/iron companies in Japan.

## Pre/ Post

- **PreSys** is an engineering simulation solution for FE model development. It offers an intuitive user interface with many streamlined functions, allowing fewer operation steps with a minimum amount of data entry.
- **JVISION** - Multipurpose pre/post-processor for FE solver. It has tight interface with LS-DYNA. Users can obtain both load reduction for analysis work and model quality improvements.

## Biomechanics

- **The AnyBody Modeling System™** is a software system for simulating the mechanics of the live human body working in concert with its environment.

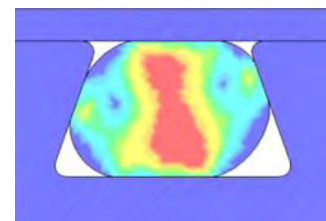
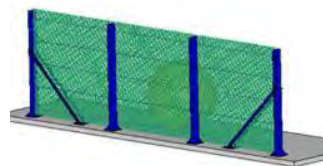
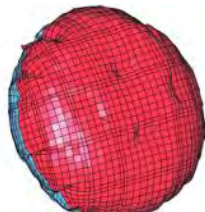
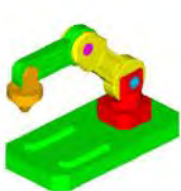



### ALL-NEW FORD F-150 AND MUSTANG MACH-E EARN NORTH AMERICAN TRUCK AND UTILITY OF THE YEAR HONORS

JAN 11, 2021 | DEARBORN, MICH.

- All-new, all-electric Mustang Mach-E and all-new Ford F-150 are named 2021 North American Utility and Truck of the Year by a 50-member independent jury of print and broadcast journalists from the U.S. and Canada
- The winning vehicles are benchmarks in their segments based on factors including innovation, design, safety, handling, driver satisfaction and value for the dollar
- Both models have connected vehicle technology, including over-the-air updates, that keeps them in the forefront of purposeful technology and ensures customers' future wants and needs are met through the life of the vehicle

**DEARBORN, Mich., Jan. 11, 2021** – Ford starts 2021 with not one, but two coveted accolades as the all-new, all-electric Mustang Mach-E and the all-new Ford F-150 claim the 2021 North American Utility and Truck of the Year.

“This recognition for Mustang Mach-E and F-150 is validation not only for our brand, but also for our Ford team, which continues to innovate and deliver on its commitment to creating must-have products and services,” said Kumar Galhotra, president, Ford Americas and IMG. “The North American Car, Utility and Truck of the Year awards are among the most prestigious in the industry and such an honor serves as a capstone achievement for years of hard work for the Mustang Mach-E and F-150 teams.”

It is the first time since 2014 that the same brand has won multiple North American vehicle of the year awards in the same year.

Ford brought the all-new, [all-electric Mustang Mach-E](#) to life through a development process concentrated entirely on customer needs and desires, resulting in a sleek, beautiful SUV that delivers spirited ride and handling – with state-of-the-art connected vehicle technology that makes it even better over time.

This is the third in a series of recent awards that saw a Mustang Mach-E and F-150 double feature – both earned accolades in December for [the Edmunds Top Rated Luxury EV and Edmunds Top Rated Truck of 2021](#), on top of recognition as [the Green Car Journal 2021 Green Car of the Year and Green Truck of the Year](#).

Mustang Mach-E also was named Best Car to Buy 2021 by [The Car Connection](#) and [Green Car Reports](#) earlier this month.

[The all-new F-150](#) is purpose-built to be the toughest, most productive F-150 ever, targeting the most towing and payload of any light-duty full-size pickup and introducing all-new features to increase customer productivity. F-150 has new connected vehicle innovations such as over-the-air updates that help keep it at the forefront of purposeful technology as well as an available all-new 3.5-liter PowerBoost™ hybrid powertrain with Pro Power Onboard™ – an integrated power generator.

The North American Car, Utility and Truck of the Year awards are intended to recognize the most outstanding new vehicles of the year. These vehicles are benchmarks in their segments based on factors including innovation, design, safety, handling, driver satisfaction and value for the dollar.

The organization gives out three awards: “North American Car of the Year,” “North American Utility Vehicle of the Year,” and “North American Truck of the Year.” The awards are given by an independent jury of automotive journalists from the United States and Canada instead of by a single publication, website, radio or television station.

### **The accolades keep coming**

The North American Utility and Truck of the Year awards are just two of many accolades Mustang Mach-E and F-150 have earned in recent months:

#### **Ford F-150**

- Detroit Free Press Truck of the Year - Detroit Free Press
- Green Truck of the Year - Green Car Journal
- Best Buy Award - Kelley Blue Book
- Edmunds Top Rated Truck - Edmunds.com

[Read from website](#)

#### **Ford Mustang Mach-E**

- Green Car of the Year - Green Car Journal
- Edmunds Top Rated Luxury EV - Edmunds
- Best Car to Buy 2021- The Car Connection
- Best Electric Car to Buy 2021 - The Car Connection
- Best Crossover to Buy 2021 - The Car Connection
- Best Car to Buy 2021 - Green Car Reports

#### **About Ford Motor Company**

Ford Motor Company (NYSE: F) is a global company based in Dearborn, Michigan. The company designs, manufactures, markets and services a full line of Ford cars, trucks, SUVs, electrified vehicles and Lincoln luxury vehicles, provides financial services through Ford Motor Credit Company and is pursuing leadership positions in electrification; mobility solutions, including self-driving services; and connected services. Ford employs approximately 187,000 people worldwide. For more information regarding Ford, its products and Ford Motor Credit Company, please visit [corporate.ford.com](https://corporate.ford.com).



# *LS-DYNA - Resource Links*

---

**LS-DYNA Multiphysics YouTube**  
<https://www.youtube.com/user/980LsDyna>

**FAQ LSTC**  
<ftp.lstc.com/outgoing/support/FAQ>

**LS-DYNA Support Site**  
[www.dynasupport.com](http://www.dynasupport.com)

**LS-OPT & LS-TaSC**  
[www.lsoptsupport.com](http://www.lsoptsupport.com)

**LS-DYNA EXAMPLES**  
[www.dynaexamples.com](http://www.dynaexamples.com)

**LS-DYNA CONFERENCE PUBLICATIONS**  
[www.dynalook.com](http://www.dynalook.com)

**ATD –DUMMY MODELS**  
[www.dummymodels.com](http://www.dummymodels.com)

**LSTC ATD MODELS**  
[www.lstc.com/models](http://www.lstc.com/models)    [www.lstc.com/products/models/maillinglist](http://www.lstc.com/products/models/maillinglist)

**AEROSPACE WORKING GROUP**  
<http://awg.lstc.com>

# Training - Webinars



## Participant's Training Classes

**Webinars**

**Info Days**

**Class Directory**

## Directory

<b>ANSYS</b>	<a href="https://www.ansys.com/services/training-center">https://www.ansys.com/services/training-center</a>
<b>BETA CAE Systems</b>	<a href="http://www.beta-cae.com/training.htm">www.beta-cae.com/training.htm</a>
<b>DYNAMore</b>	<a href="http://www.dynamore.de/en/training/seminars">www.dynamore.de/en/training/seminars</a>
<b>Dynardo</b>	<a href="http://www.dynardo.de/en/wost.html">http://www.dynardo.de/en/wost.html</a>
<b>ESI-Group</b>	<a href="https://myesi.esi-group.com/trainings/schedules">https://myesi.esi-group.com/trainings/schedules</a>
<b>ETA</b>	<a href="http://www.eta.com/training">http://www.eta.com/training</a>
<b>KOSTECH</b>	<a href="http://www.kostech.co.kr">www.kostech.co.kr</a>
<b>ANSYS LST</b>	<a href="http://www.lstc.com/training">www.lstc.com/training</a>
<b>LS-DYNA OnLine - (Al Tabiei)</b>	<a href="http://www.LSDYNA-ONLINE.COM">www.LSDYNA-ONLINE.COM</a>
<b>OASYS</b>	<a href="http://www.oasys-software.com/training-courses">www.oasys-software.com/training-courses</a>
<b>Predictive Engineering</b>	<a href="http://www.predictiveengineering.com/support-and-training/ls-dyna-training">www.predictiveengineering.com/support-and-training/ls-dyna-training</a>

# LS-DYNA Online Training



Contact : 513-331-9139  
Email : courses@lsdyna-online.com

## LS-DYNA LIVE ONLINE TRAINING & CONSULTING SERVICES

Lsdyna online was created by the LSTC instructor after 25 years of teaching various LS-DYNA courses for LSTC nationally and internationally (more than 20 countries). The online company was established in 2012 and we have been providing many live interactive courses to many companies and organizations. We do consulting work in addition to instructions. Here are some courses, for full list see our webpage.

 <b>1. Introduction to LS-DYNA (2 days @ \$800)</b> December 11-12	 <b>13. Plasticity, Plastics, &amp; Visco-Plasticity (2 day @ \$1000)</b> November 2-3
 <b>2. Composites in LS-DYNA (2 days @ \$1000)</b> October 1-2	 <b>14. Penetration Using LS-DYNA (2 days @ \$1000)</b> June 15-16
 <b>4. Fracture, Damage, &amp; Failure (2 days @ \$1000)</b> October 5-6	 <b>15. Composite Materials (1 day @ \$500)</b> October 30
 <b>5. Fluid Structure Interaction (2 days @ \$1000)</b> September 29-30	 <b>16. Blast using LS-DYNA (2 days @ \$1000)</b> November 5-6
 <b>6. Material Models Tests to Simulation (2 days @ \$1000)</b> October 8-9	 <b>17. Introduction to LS-PREPOST (1 day @ \$500)</b> November 4
 <b>3. Contact in LS-DYNA (2 days @ \$1000)</b> October 12-13	 <b>18. Advance LS-PREPOST (1 day @ 500)</b> email us for dates

### About Tabiei

Dr. Al Tabiei has been a consultant on the use of large scale finite element simulation for more than 25 years to more than 80 large and small companies and government labs in the US and abroad. He was the director of the Center of Excellence in DYNA3D Analysis at the University of Cincinnati (1997-2001). He has more than 150 journal, refereed reports, and conferences papers

He lectured at nearly 20 countries. He also did code development for LSTC. The instructor has developed and implemented many material models in LS-DYNA. Composite Shell element for composite materials and various other development in the code. He was consultant to the US government for several years on the use of simulation for home land security problems. He has served as a Subject Matter Expert (SME) for the government for more than 20 years. He was also on a NASA team for the return to the moon program to investigate different landing scenarios (2006-2010).



## Multiaxial fatigue analysis with LS-DYNA®

Yun Huang<sup>1</sup>, Anders Jonsson<sup>2</sup>, Marcus Lilja<sup>2</sup>

<sup>1</sup>Livermore Software Technology, an ANSYS company, US

<sup>2</sup>DYNAmore Nordic AB, Sweden

### Abstract

*Fatigue life is an important dimensioning criterion within product development. Several tools and software are today available and are widely used for fatigue assessment within the CAE process. To further improve the capabilities for integrated fatigue analysis in LS-DYNA, a time domain fatigue solver has been developed and implemented by LST (an ANSYS company), as a compliment to the already existing frequency domain fatigue solvers. As of coming releases of LS-DYNA, different options for fatigue analyses will be available, based on the results from general load cases and structures including e.g. non-linearities, non-proportional and multiaxial loading conditions.*

*The time domain fatigue analysis can be based on stress or strain results from all time domain solvers (implicit, explicit, thermal, FSI, etc.) in LS-DYNA. The stress or strain state of the elements is usually three dimensional, especially for the parts under multiaxial loading cases like bending or twisting. However, the standard procedure to obtain the SN curve or EN curve is based on nominal stress or strain of the specimen, which is a scalar not a tensor.*

*Several options to deal with the multiaxial stress state for fatigue analysis have been implemented in LS-DYNA (keyword \*FATIGUE\_MULTIAXIAL). They include*

- 1. Running fatigue analysis based on an equivalent stress index (e.g. von Mises stress);*
- 2. Running fatigue analysis on multiple planes and picking the highest damage ratio across the planes as the fatigue damage ratio of the element;*
- 3. Locating a critical plane first and projecting the whole stress history to the critical plane and then running fatigue analysis on the critical plane.*

*Several examples are given in this paper, to discuss the different options for multiaxial fatigue analysis, including a crankshaft model and a cylinder bar model with a groove. Validation has been performed by comparing the simulation results from simple test cases to analytical results from the same load cases. Also, a comparison of the fatigue analysis results from LS-DYNA to the results from the fatigue postprocessing module mFAT (a plug-in to the post-processor META) is presented in this paper.*

## Introduction

Fatigue analysis is critical to the design and optimization of structures and parts involving metal components. To meet the requirements from users for running fatigue and durability analysis, a fatigue analysis module is needed in LS-DYNA.

Starting from R7 version of LS-DYNA 971, a series of frequency domain fatigue analysis methods have been implemented in LS-DYNA, to run fatigue and durability analysis based on random vibration (`*FREQUENCY_DOMAIN_RANDOM_VIBRATION_FATIGUE`), and steady state dynamics (`*FREQUENCY_SSD_FATIGUE`). These methods are based on Miner's rule of cumulative damage ratio and the S-N fatigue curves of the materials (`*MAT_ADD_FAIGUE`). They are valid for the cases of linear and elastic deformation when stress level is low.

In the case of nonlinear and elasto-plastic deformation, a time domain fatigue analysis is preferred. Recently a new keyword `*FATIGUE` was implemented to LS-DYNA, to run fatigue analysis in time domain. The time domain fatigue analysis can be based on stress cycle (S-N curve) or strain cycle (E-N curve). This method is based on Rainflow counting of stress or strain cycles. More details of the Rainflow counting can be found in Section 3 of the reference [1], as well as in many other public resources.

The stress or strain state of a material is usually multiaxial. A typical example is a crankshaft assembly subjected to twisting or torque loading. However, the material's SN curve or EN curve is usually obtained by uniaxial testing where the S and E are nominal stress and strain. To apply the uniaxial SN or EN curve on the multiaxial fatigue analysis, some manipulation or simplification of the stress tensor is required. In LS-DYNA, several options for multiaxial fatigue analysis have been implemented. They include

1. Running fatigue analysis based on an equivalent stress index (e.g. von Mises stress);
2. Running fatigue analysis on multiple planes and picking the highest damage ratio across the planes as the fatigue damage ratio of the element;
3. Locating a critical plane first and projecting the whole stress history to the critical plane and then running fatigue analysis on the critical plane

More details of the three options will be given in following sections.

For benchmarking of the new time domain fatigue solver in LS-DYNA, some examples are given in this paper. For two of the examples, the results by LS-DYNA were compared with the corresponding results from the fatigue tool mFAT [2] (a plug in to the META [3] post-processor of BETA CAE). Most of the description and examples are based on using stress for fatigue analysis, but the same techniques can be used for strain-based fatigue analysis too.

## Multiaxial fatigue analysis method

### **Keyword**

The multiaxial fatigue analysis is activated by the keyword `*FATIGUE_MULTIAXIAL`, in addition to the keyword `*FATIGUE`. More details on the two keywords can be found in the LS-DYNA Keyword Users' manual [4]. The keyword `*FATIGUE_MULTIAXIAL` has only 1 card:

# LS-DYNA New Feature and Application

Card 1	1	2	3	4	5	6	7	8
Variable	MAXIAL	NPLANE						
Type	I	I						
Default	0	18						

## VARIABLE

## DESCRIPTION

### MAXIAL

Multiaxial fatigue analysis criterion:

EQ.0: fatigue analysis using equivalent stress or strain index (defined by INDEX in \*FATIGUE)

EQ.1: fatigue analysis on multiple planes

EQ.2: fatigue analysis on critical plane which is determined by the highest 1<sup>st</sup> principal stress or strain

### NPLANE

Number of planes for fatigue analysis (for MAXIAL = 1 only)

### ***Equivalent stress index method***

The first method (MAXIAL = 0) to deal with the multiaxial fatigue problem is to use an appropriate scalar stress invariant in the fatigue analysis. The commonly used scalar stress invariant includes: von Mises stress, maximum principal stress, maximum shear stress, etc. These stress invariants can be computed with the 6 stress components (3 normal stresses and 3 shear stresses). The main issue with this approach is that the change of principal directions of stresses during the transient procedure cannot be considered.

### ***Multiple-plane method***

The second method (MAXIAL = 1) to deal with the multiaxial fatigue problem is to project the stress tensor to multiple planes and run an individual fatigue analysis with the normal stress on each plane. After that, the maximum value is picked from the fatigue damage ratios on the multiple planes and this maximum value is designated as the accumulative fatigue damage ratio of that element. The number of planes is defined by NPLANE. The default value of NPLANE is 18, which means there is a 20° angle between two adjacent planes.

This method is more applicable to shell elements with plane stress state. Another issue is that this method can be expensive in computational cost, since the fatigue analysis needs to be performed on multiple planes.

### ***Critical plane method***

Instead of running fatigue analysis on multiple evenly spaced planes, one can try to locate a critical plane for the whole stress history for each element and project the stress tensor onto this “fixed” plane for the entire time history. Consequently, the fatigue analysis needs to be performed only once on each element and this can gain big saving in computational cost, comparing with the multiple-plane method. A detailed description of the method to locate the critical plane can be found in Section 3 of the paper [1]. This critical plane method is activated by MAXIAL = 2.

## Example 1: A plate with predefined notch

### Model

The model used in this section is shown in Figure 1. It is composed of 2039 shell elements. Elastic material is assumed for this model. The material properties are shown in Table 1.

Table 1. Assumed material data for the plate model

Material	Density	Young's modulus	Poisson's ratio
Steel	7800 kg/m <sup>3</sup>	210 GPa	0.3

As shown in Figure 1, the plate is constrained (6 dof each node) at the edge of the hole and is loaded by cyclic nodal force by one node on the plate. The nodal force lasts for 10000.0 seconds and is defined as

$$F = \sin(22.0\pi t) \quad (1)$$

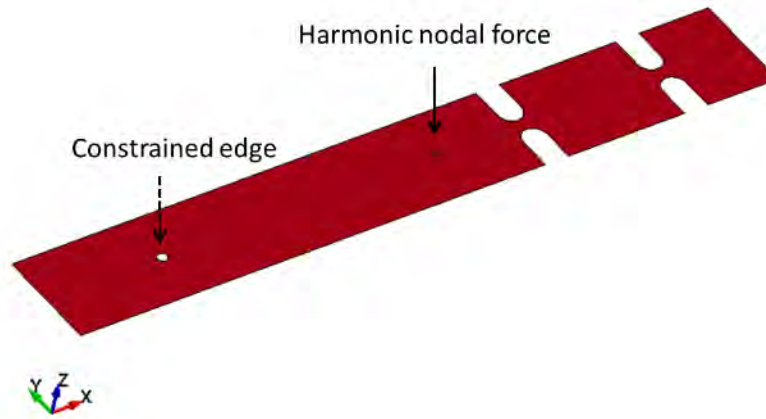

Figure 1. A plate subjected to harmonic nodal force excitation

Due to the out of plane loading, the plate will be subjected to cyclic bending stresses which is three-dimensional. The three different multiaxial fatigue analysis methods were used for this model and fringe plot of their results are shown in Figures 2-4. For the first method (equivalent stress index method), Signed von mises stress was used as the equivalent stress index; For the second method (multiple-plane method), 36, 72 and 180 planes were used separately for the computation of the cumulative damage ratio.

As can be seen from Figures 2-4, the resulting distribution of the cumulative damage ratio from these three different methods are very similar, and the maximum values are close (from 1.369 to 1.410).

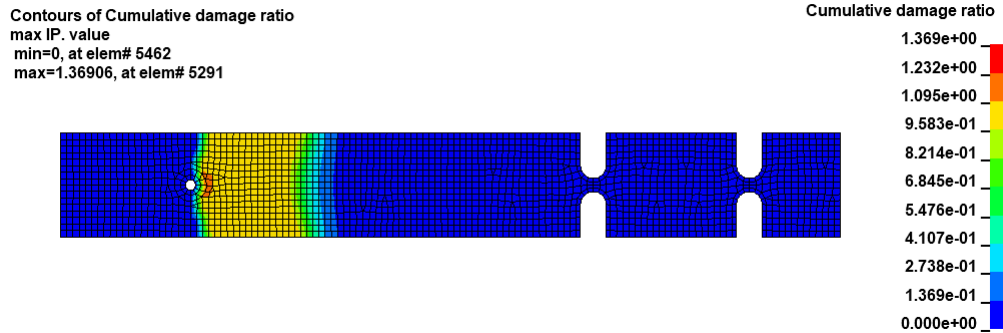

Figure 2. Cumulative damage ratio for the plate, with MAXIAL = 0

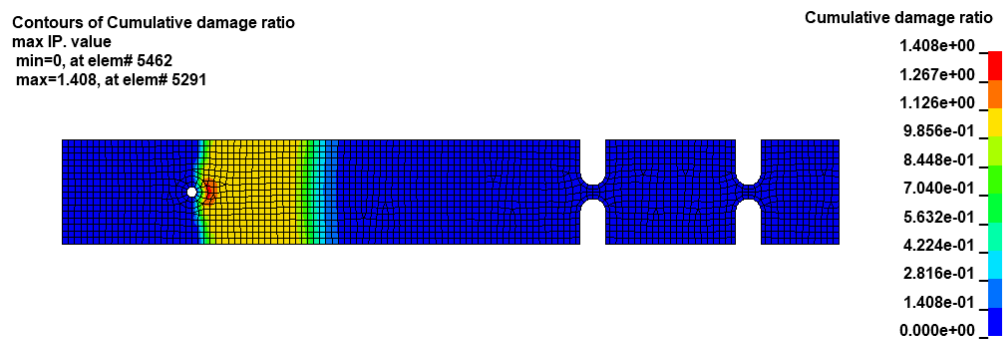

Figure 3. Cumulative damage ratio for the plate, with MAXIAL = 1 and NPLAE = 36

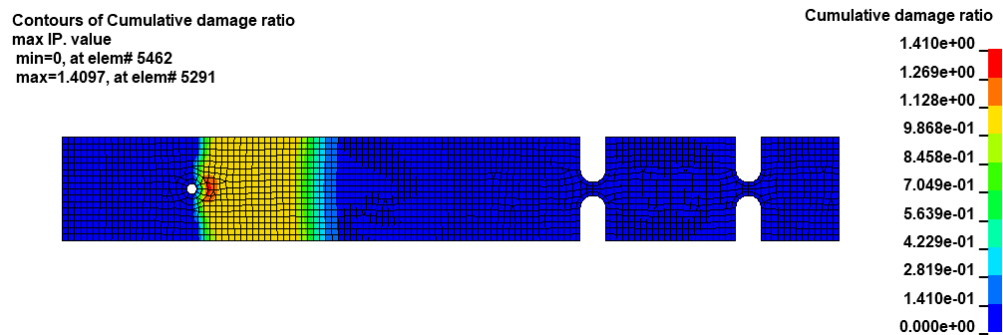

Figure 4. Cumulative damage ratio for the plate, with MAXIAL = 2

The maximum values of cumulative damage ratio (D) in the model, by different methods, are presented in Table 2. The cumulative damage ratios by the critical plane method and the multiple plane method are higher than that by the equivalent stress index method, as the principal stress direction may change with time. Increasing the number of planes when using the multiaxial option (MAXIAL = 1) enhances the solution accuracy and the value of the fatigue damage converges.



# LS-DYNA New Feature and Application

Table 2. Maximum cumulative damage ratio D of the plate, by different multiaxial fatigue analysis methods

MAXIAL	NPLANE	Max. D	Element showing max D
0		1.36906	5291
1	36	1.4080	5291
1	72	1.40847	5291
1	180	1.40846	5291
2		1.4097	5291

## Example 2: A crankshaft assembly

### Model

In this Section, an example of a fatigue analysis of a crankshaft assembly, see Figure 5, is presented. This example has previously [1] been used to demonstrate the capabilities of the fatigue tool mFAT [2], which is a plug-in to the post-processor META [3] of BETA CAE. The crankshaft assembly represents a typical small-size (bore  $\varnothing$  75 mm, stroke 74 mm, total displacement 1.3 L) engine. Only one cylinder is included in the model, and the engine block and cylinder liner are represented by displacement boundary conditions on the crankshaft bearings and the piston, respectively. The FE-model consists mostly of solid elements (1<sup>st</sup> and 2<sup>nd</sup> order tets, 1<sup>st</sup> order hexa). In order to evaluate stresses at the surfaces, the solids were covered with thin membrane elements. Since the model was developed for demonstrational purposes only, a rather coarse mesh was used, and stresses in critical areas would most likely not be satisfactory resolved for a proper fatigue analysis. The total model size is 4E5 elements.

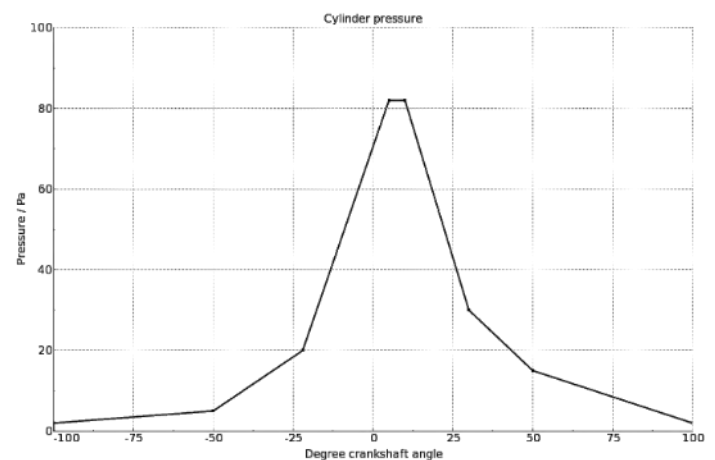

Figure 5. Left image: The crankshaft assembly consists of the crankshaft, conrod, piston pin and piston. Right image: The assumed cylinder pressure curve.

# LS-DYNA New Feature and Application

A quasi-static analysis (neglecting crankshaft dynamics) of the work phase (compression and expansion) was performed using the implicit solver of LS-DYNA. A distributed pressure was applied to the top face of the cylinder, following a simplified cylinder pressure curve according to the right image of Figure 5, and a prescribed rotation (totally 200°) was applied to flywheel end of the crankshafts. Contacts in bearings etc. were included using Mortar contacts. Assumed linear elastic material data according to Table3 was applied to the different parts.

Table 3. Assumed material data for the different parts of the crankshaft assembly

Part	Material	Young's modulus	S <sub>u</sub>	N <sub>u</sub>	m <sub>1</sub>	m <sub>2</sub>
Crankshaft	Steel	210 GPa	400 MPa	2.E6	5	11
Conrod	Steel	210 GPa	600 MPa	2.E6	6	13
Piston pin	Steel	210 GPa	800 MPa	2.E6	6	13
Piston	Aluminum	70 GPa	100 MPa	1.E6	4	9

The effective stress at two states of the analysis is shown in Figure 6.

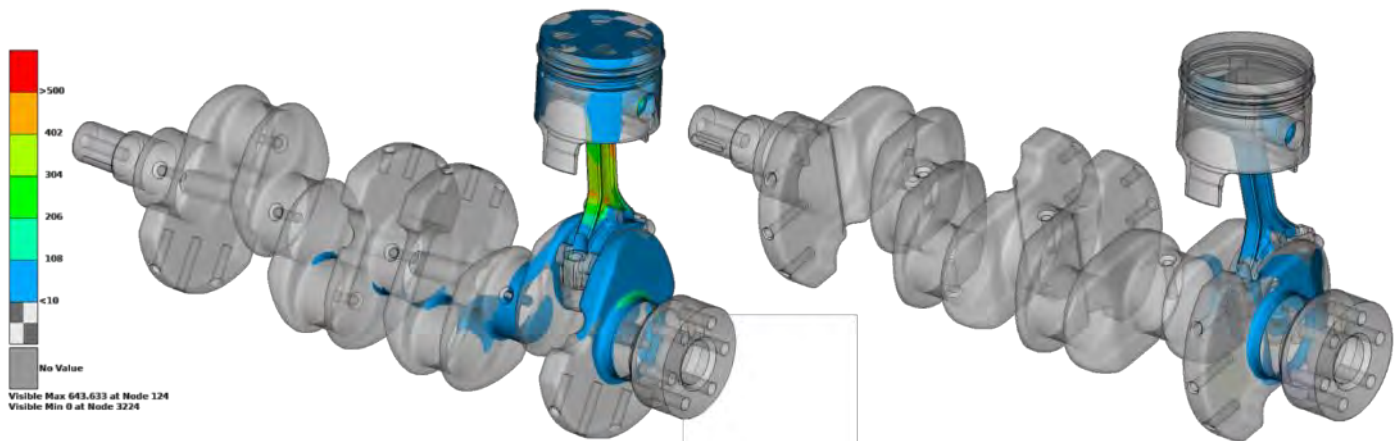

Figure 6. The fringe plots show the effective stress in the crankshaft model at two positions during the analysis, from 10 (blue) to 500 MPa (red). The left image shows the configuration with maximum stress, while the right image shows the configuration during the expansion phase. Areas with stress below 10 MPa are shown as semi-transparent.

## Fatigue analysis results

Based on the FE-analysis of the crankshaft motion, fatigue analyses were performed using mFAT and LS-DYNA. In mFAT, a simple critical plane approach is used: it is assumed that the normal to the critical plane, for each element respectively, is given by the direction corresponding to the principal stress with the maximum absolute value during the analysis. Then the stress history is projected onto this direction, and fatigue damage is computed using rainflow count and linear damage accumulation.

In LS-DYNA, the fatigue analysis was activated by the \*FATIGUE\_ELOUT keyword. The multiaxial fatigue option  $MAXIAL = 2$  on the \*FATIGUE\_MULTIAXIAL – keyword was active, resulting in a similar fatigue evaluation as used in mFAT; fatigue analysis on a critical plane which is determined by the maximum absolute value of the principal stress.

# LS-DYNA New Feature and Application

For mFAT, the fatigue data is input using the fatigue limit  $S_u$  and the cycle limit  $N_u$  and two slopes of the S-N curve, see Figure . LS-DYNA offers more flexibility for assigning fatigue data to materials using either curves or exponents, by the keyword `*MAT_ADD_FATIGUE`.

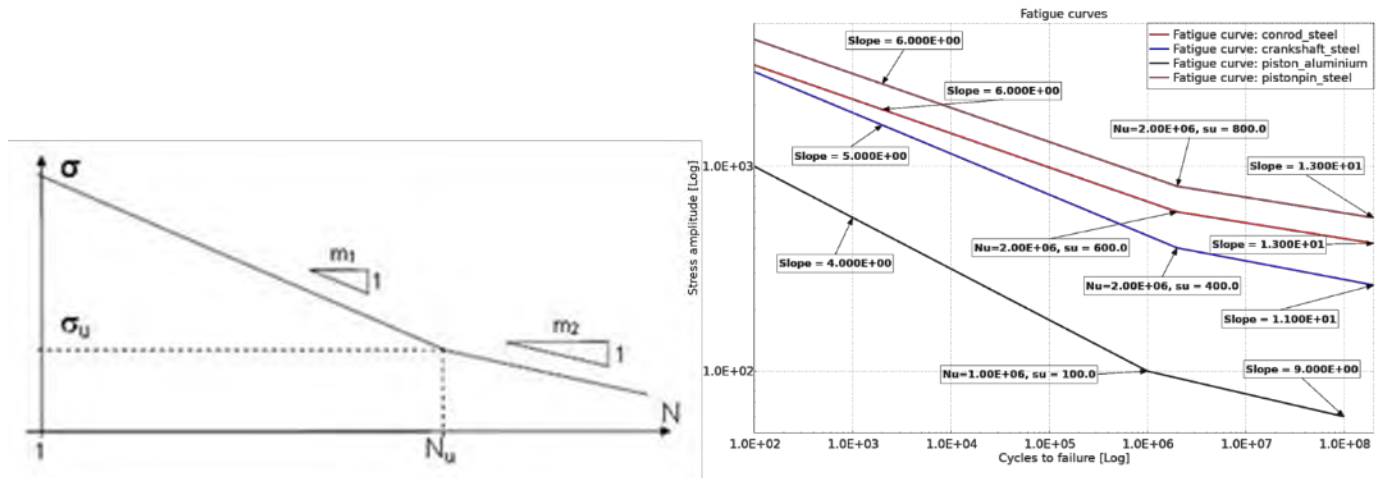

Figure 7. The left image shows the parameters ( $S_u$ ,  $N_u$ ,  $m_1$ ,  $m_2$ ) determine the S-N curve used for damage calculation used in mFAT. The right image shows the S-N curves applied for the fatigue analyses of the crankshaft assembly.

In order to be able to compare the fatigue analysis results in this case, the option `LCID = -3` was used for `*MAT_ADD_FATIGUE` and the mFAT parameters were converted to the corresponding LS-DYNA input. The fatigue damage results from LS-DYNA and mFAT are compared in Figure 8, Figure 9 and 10. Both methods indicate the same critical areas of each part respectively, and the fatigue damage results are similar in magnitude.

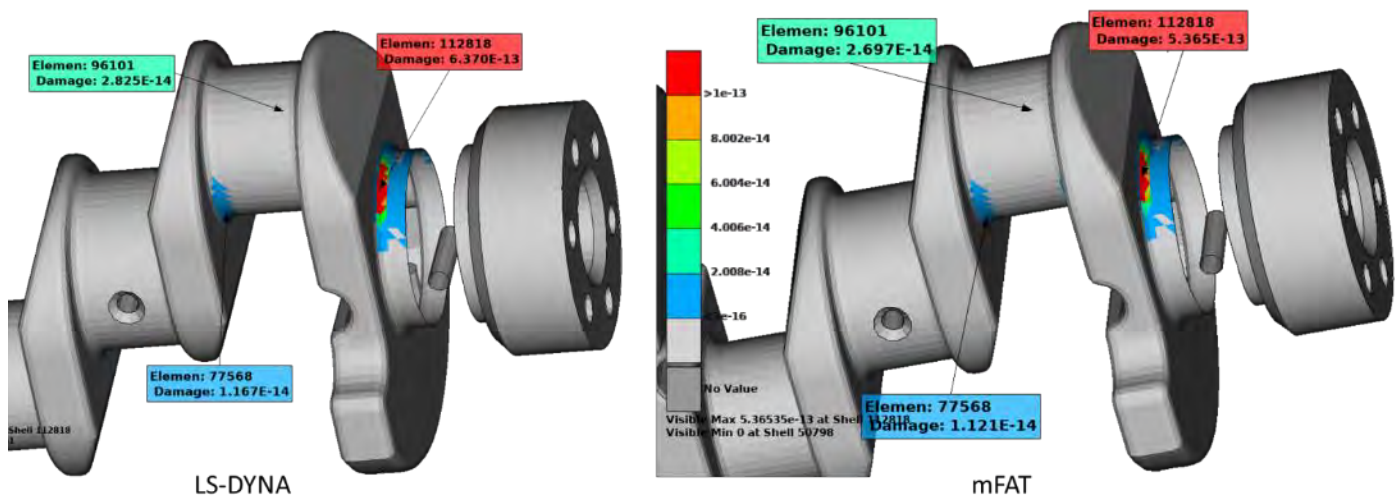

Figure 8. Comparison of the fatigue damage results for the crankshaft from LS-DYNA (left image) and mFAT (right image).

# LS-DYNA New Feature and Application

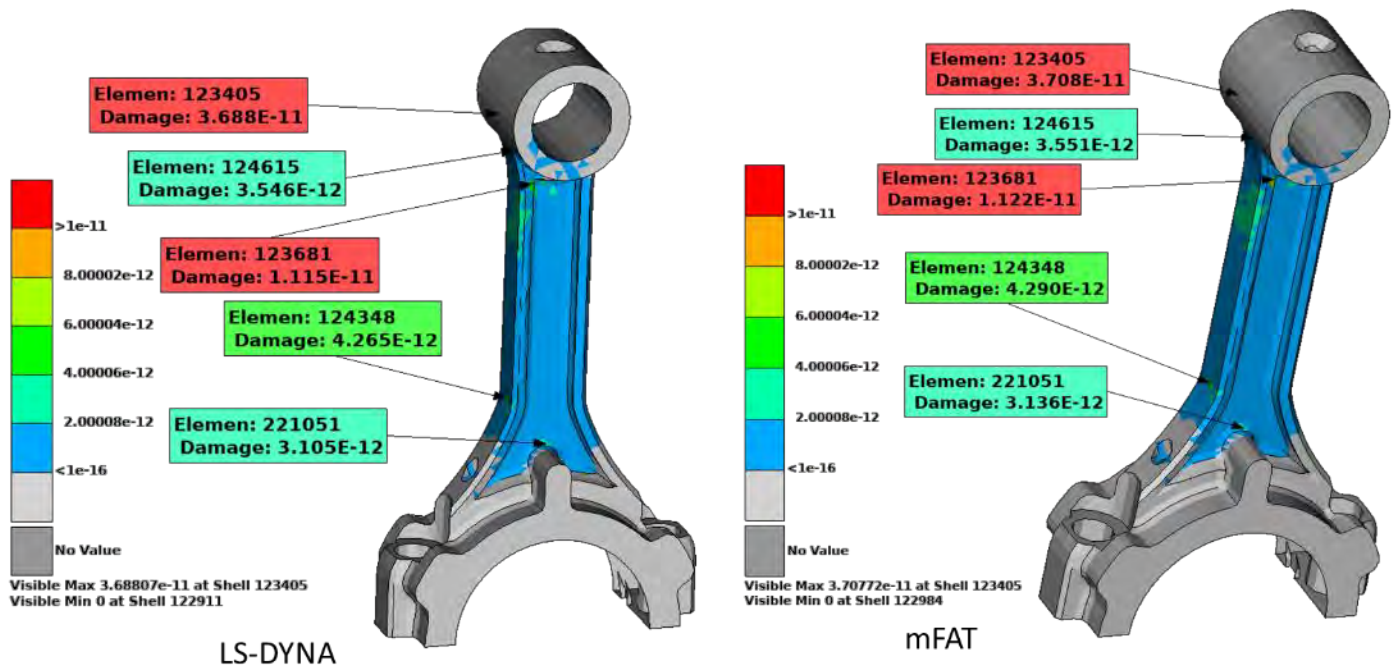

Figure 9. Comparison of the fatigue damage results for the conrod from LS-DYNA (left image) and mFAT (right image).

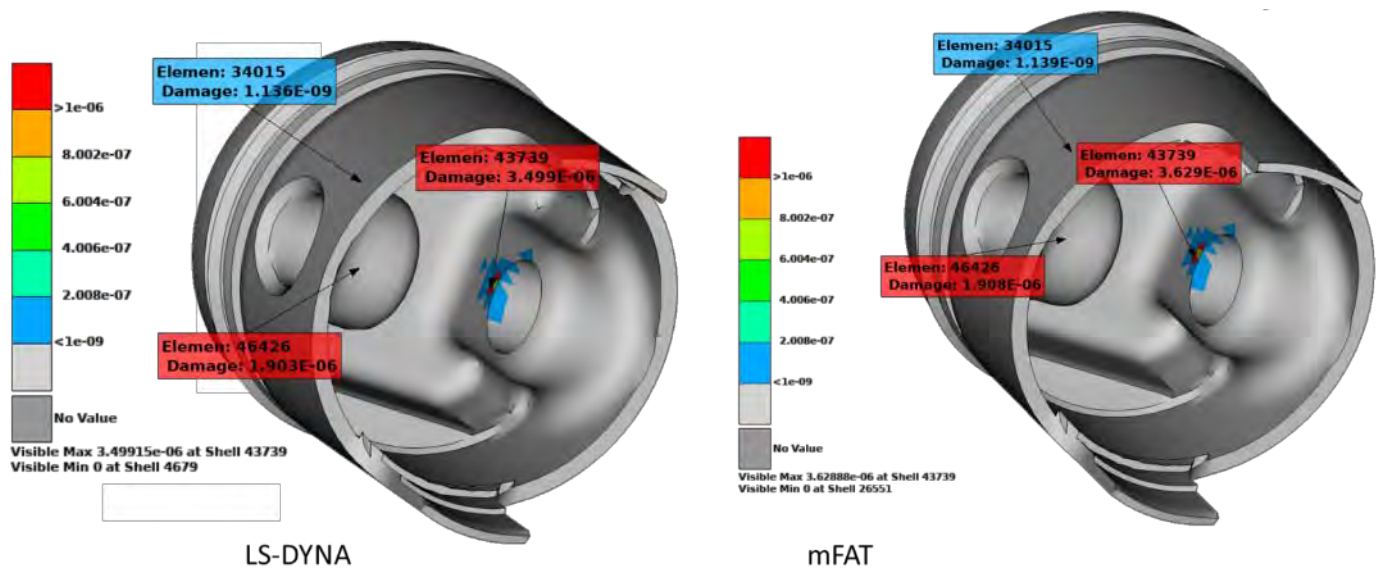

Figure 10. Comparison of the fatigue damage results for the piston from LS-DYNA (left image) and mFAT (right image).

# LS-DYNA New Feature and Application

Finally, the maximum fatigue damage results per part are summarized in Table 44. Good agreement is found between the two fatigue analysis methods. This demonstrates that LS-DYNA, by introduction of the \*FATIGUE keywords, can offer even broader applications to strength and durability analyses of complex assemblies.

Table 4. Comparison of the maximum fatigue damage ratio D per part from LS-DYNA and mFAT

Part	D by LS-DYNA	D by mFAT
Crankshaft	6.37E-13	5.37E-13
Conrod	3.69E-12	3.71E-12
Piston	3.50E-6	3.63E-6

## Example 3: Bar with a groove

In this section, a simple notched bar specimen was used. This benchmark example concerns the cycle counting algorithm and the accumulated damage. The simulated results were compared to analytical calculations where traditional rain flow count and the Palmgren-Miner rule of damage accumulation was used and to results obtained from using mFAT [2], a fatigue plug-in tool in METApst [3]. The keyword features tested were:

\*FATIGUE\_ELOUT using RESTR=1, \*FATIGUE\_LOADSTEP, \*FATIGUE\_MULTIAXIAL and \*FATIGUE\_MEAN\_STRESS\_CORRECTION. However, due to paper size restrictions, this section concerns only benchmarking of the underlying fatigue cycle counting scheme and the \*FATIGUE\_LOADSTEP keyword.

### Model

The FE-model used is shown in Figure 11. It includes 64845 nodes, 63360 solid elements. A cyclic pressure load was applied to one end of the bar while the other end was constrained in all d.o.f.'s.

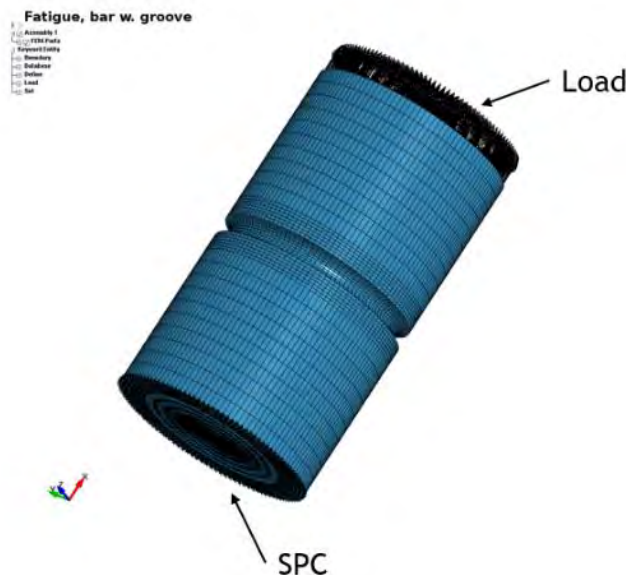

Figure 11. FE-model of bar with a groove.

# LS-DYNA New Feature and Application

## Fatigue data

The S-N curve used in the benchmark is shown in Figure 12 below. The parameters  $m_1$  and  $m_2$  are used to define the S-N curve in mFAT.

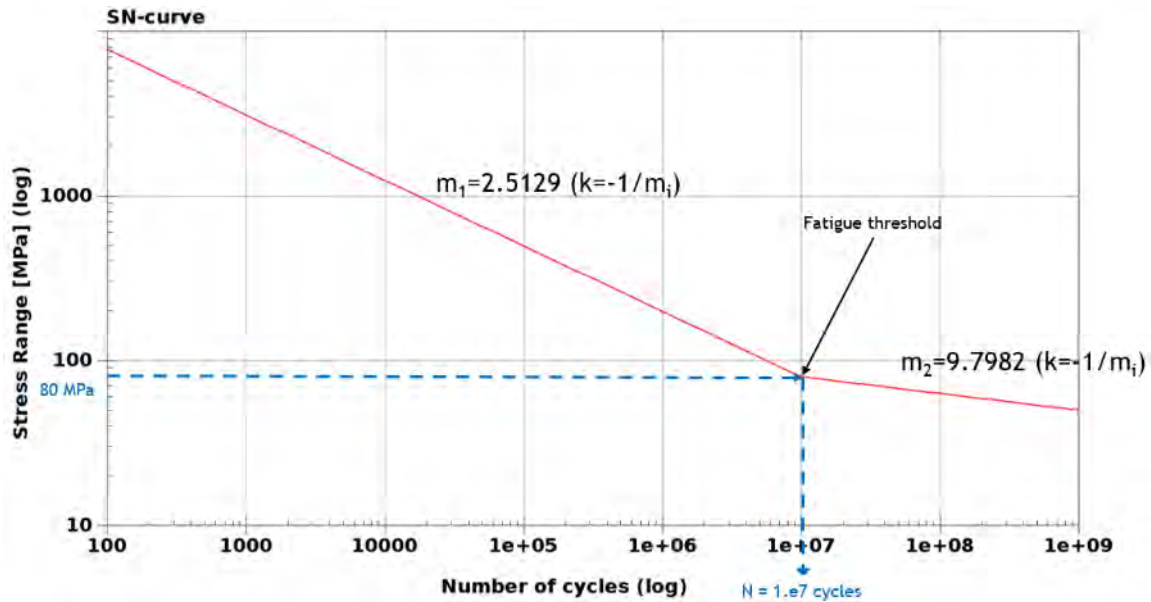

Figure 12. S-N curve used for the benchmarks

## Checking of the fatigue cycle counting algorithm

Pulsating and alternating loads were used when running this benchmark. The results were compared to analytical calculations (where cycle counting was made on elout data) and mFAT results. The loading and cycle counting are shown in Figure 13.

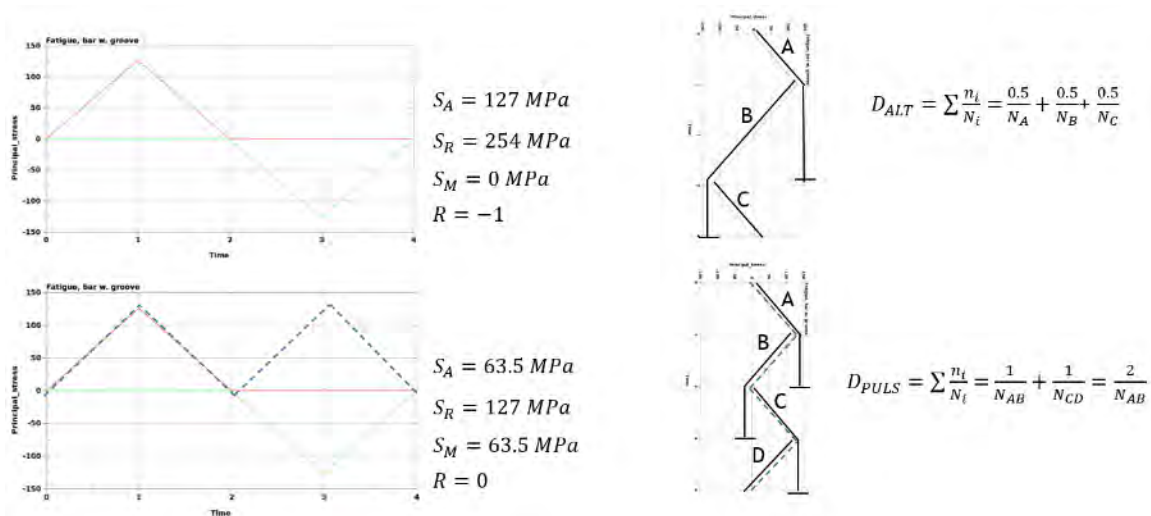

Figure 13. Fully reversed, constant amplitude load (upper) and constant amplitude, pulsating load (lower).

# LS-DYNA New Feature and Application

The results comparison is shown in Table 5. Note that the analytically calculated results include reading of an S-N curve which is not all that exact. Also, mFAT is always using a multiaxial fatigue approach based on the Principal stress. Still, the results from the above, simple exercise show very good agreement and should indicate that the cycle counting in the LS-DYNA package works as intended.

Table 5. Results from fatigue cycle counting exercise.

Case	End time	Load range	Rainflow count cycles	D, LS-DYNA	D, mFAT	D, analytical
1	2.0 Pulsating	0,1,0	1 cycle, 1 reversal	3.176E-7	3.188E-7	3.159E-7
2	4.0 Pulsating	0,1,0,1,0	2 cycles	6.351E-7	6.376E-7	6.318E-7
3	4.0 alternating	0,1,0,-1,0	1 cycle, 2 reversals	1.225E-6	1.229E-6	1.211E-6
4	4.0 alternating	0,0.5,0,-0.5,0	1 cycle, 2 reversals	1.691E-7	1.698E-7	1.680E-7

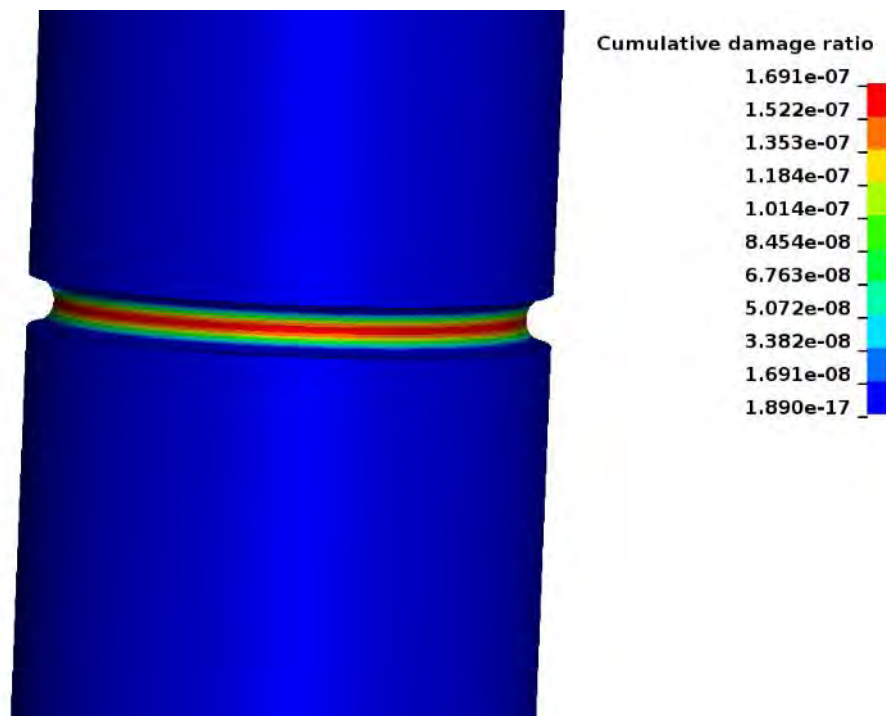
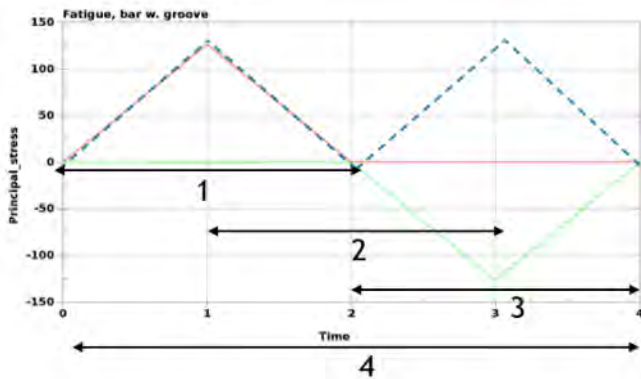

Figure 14. Acumulated fatigue damage for case 4.

## Checking of the \*FATIGUE\_LOADSTEP functionality

The definitions of the load cases used for checking the load step function are shown in Figure 15 and the cycle counting for the sequence is shown in Figure 16.

# LS-DYNA New Feature and Application



$$S_A = 63.5 \text{ MPa}$$

$$S_R = 127 \text{ MPa}$$

$$S_M = 63.5 \text{ MPa}$$

$$R = 0$$

Case no.	Start at time	End at time
1	0	2
2	1	3
3	2	4
4	0	4

Figure 15. Load step definitions.

The Rainflow counting is performed on elout time-history data as shown in Figure 16.

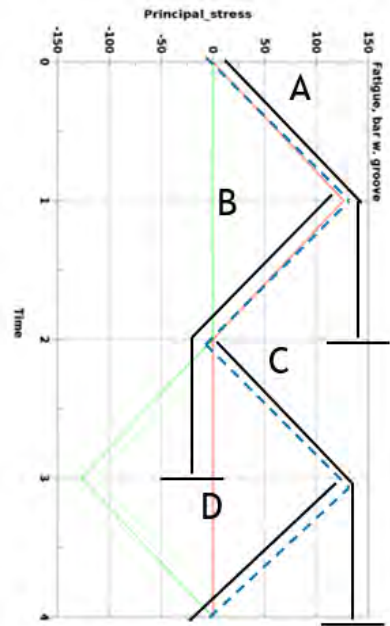

$$D_{PULS} = \sum \frac{n_i}{N_i} = \frac{1}{N_{AB}} + \frac{1}{N_{CD}} = \frac{2}{N_{AB}}$$

Figure 16. Analytical rainflow counting and damage accumulation.

The benchmark results are shown in Table 6. As seen the agreement to analytical calculation results is good.

Table 6. Results from the load step functionality benchmark.

Case No.	D, LS-DYNA	D, analytical	D, mFAT
1	3.176E-7	3.159E-7	3.176E-7
2	3.176E-7	3.159E-7	3.176E-7
3	3.176E-7	3.159E-7	3.176E-7
4	6.351E-7	6.318E-7	6.351E-7



# *LS-DYNA New Feature and Application*

---

As can be seen from the comparison, \*FATIGUE\_{OPTION} in LS-DYNA shows good agreement to analytically calculated results and to mFAT results. The cycle counting seems to follow the rule of a classical fatigue cycle counting algorithm well, the calculated accumulated damage shows good agreement to Palmgren-Miner and the loadstep functionality yield results close to the analytical solutions and are therefore judged as reliable and accurate.

## **Summary**

This paper provides a brief review of multiaxial fatigue analysis with LS-DYNA. The methods and options of the multiaxial fatigue analysis are introduced. Several examples are also included to demonstrate the effectiveness of the implemented methods. Comparison of LS-DYNA fatigue analysis results with fatigue results by other software and by analytical solution is also included. The new keyword \*FATIGUE\_LOADSTEP was also checked in the last example. It is confirmed that LS-DYNA fatigue analysis results have a good match with the results given by other software, and the results given by analytical solutions when available.

The future development includes possibly more advanced fatigue model (for example the Dang-Van criterion), as well as fatigue analysis on spot welds, HAZ and squeezing zone, etc.

## **References**

- [1] Jonsson, A., Sjöberg, M., and Grenwald, J., mFAT – a basic fatigue module for  $\mu$ ETA – Post, 6<sup>th</sup> International BETA Conference, Thessaloniki 2015, internet source: [https://www.beta-cae.com/events/c6pdf/4C\\_2\\_DYNAMORE.pdf](https://www.beta-cae.com/events/c6pdf/4C_2_DYNAMORE.pdf)
- [2] Jonsson, A., mFAT v1.1 – fatigue analysis package for  $\mu$ ETA, Dynamore Nordic Report 140411, Linköping 2015.
- [3] META Post Processor version 20.0.X. User Guide, BETA CAE Systems International AG, 2019.
- [4] Livermore Software Technology, an ANSYS company, LS-DYNA<sup>®</sup> Keyword User's Manual, 2020.



**BETA CAE Systems.**

[www.beta-cae.com](http://www.beta-cae.com)

## **BETA CAE Systems - ANSA**

An advanced multidisciplinary CAE pre-processing tool that provides all the necessary functionality for full-model build up, from CAD data to ready-to-run solver input file, in a single integrated environment. ANSA is a full product modeler for LS-DYNA, with integrated Data Management and Process Automation. ANSA can also be directly coupled with LS-OPT or LST, an ANSYS company to provide an integrated solution in the field of optimization.

## **BETA CAE Systems $\mu$ ETA**

Is a multi-purpose post-processor meeting diverging needs from various CAE disciplines. It owes its success to its impressive performance, innovative features and capabilities of interaction between animations, plots, videos, reports and other objects. It offers extensive support and handling of LS-DYNA 2D and 3D results, including those compressed with SCAI's FEMZIP software.

## **Solutions for:**

Process Automation - Data Management – Meshing – Durability - Crash & Safety NVH - CFD  
- Thermal analysis - Optimization - Powertrain  
Products made of composite materials - Analysis Tools -  
Maritime and Offshore Design - Aerospace engineering - Biomechanics



ETA – Engineering Technology Associates  
[etainfo@eta.com](mailto:etainfo@eta.com)

[www.eta.com](http://www.eta.com)

## **Invention Suite™**

Invention Suite™ is an enterprise-level CAE software solution, enabling concept to product. Invention's first set of tools will be released soon, in the form of an advanced Pre & Post processor, called PreSys.

Invention's unified and streamlined product architecture will provide users access to all of the suite's software tools. By design, its products will offer a high performance modeling and post-processing system, while providing a robust path for the integration of new tools and third party applications.

## **PreSys**

Invention's core FE modeling toolset. It is the successor to ETA's VPG/PrePost and FEMB products. PreSys offers an easy to use interface, with drop-down

menus and toolbars, increased graphics speed and detailed graphics capabilities. These types of capabilities are combined with powerful, robust and accurate modeling functions.

## **VPG**

Advanced systems analysis package. VPG delivers a unique set of tools which allow engineers to create and visualize, through its modules--structure, safety, drop test, and blast analyses.

## **DYNAFORM**

Complete Die System Simulation Solution. The most accurate die analysis solution available today. Its formability simulation creates a "virtual tryout", predicting forming problems such as cracking, wrinkling, thinning and spring-back before any physical tooling is produced.



**get it right® Visual-Environment** is an integrative simulation platform for simulation tools operating either concurrently or standalone for various solver. Comprehensive and integrated solutions for meshing, pre/post processing, process automation and simulation data management are available within same environment enabling seamless execution and automation of tedious workflows. This very open and versatile environment simplifies the work of CAE engineers across the enterprise by facilitating collaboration and data sharing leading to increase of productivity.

**Visual-Crash DYNA** provides advanced preprocessing functionality for LS-DYNA users, e.g. fast iteration and rapid model revision processes, from data input to visualization for crashworthiness simulation and design. It ensures quick model browsing, advanced mesh editing capabilities and rapid graphical assembly of system models. Visual-Crash DYNA allows graphical creation, modification and deletion of LS-DYNA entities. It comprises tools for checking model quality and simulation parameters prior to launching calculations with the solver. These tools help in correcting errors and fine-tuning the model and simulation before submitting it to the solver, thus saving time and resources.

Several high productivity tools such as advanced dummy positioning, seat morphing, belt fitting and airbag folder are provided in **Visual-Safe**, a dedicated application to safety utilities.

**Visual-Mesh** is a complete meshing tool supporting CAD import, 1D/2D/3D meshing and editing for linear and quadratic meshes. It supports all meshing capabilities, like shell and solid automesh, batch meshing, topo mesh, layer mesh, etc. A convenient Meshing Process guides

you to mesh the given CAD component or full vehicle automatically.

**Visual-Viewer** built on a multi-page/multi-plot environment, enables data grouping into pages and plots. The application allows creation of any number of pages with up to 16 windows on a single page. These windows can be plot, animation, video, model or drawing block windows. Visual-Viewer performs automated tasks and generates customized reports and thereby increasing engineers' productivity.

**Visual-Process** provides a whole suite of generic templates based on LS-DYNA solver (et altera). It enables seamless and interactive process automation through customizable LS-DYNA based templates for automated CAE workflows.

All generic process templates are easily accessible within the unique framework of Visual-Environment and can be customized upon request and based on customer's needs.

**VisualDSS** is a framework for Simulation Data and Process Management which connects with Visual-Environment and supports product engineering teams, irrespective of their geographic location, to make correct and realistic decisions throughout the virtual prototyping phase. VisualDSS supports seamless connection with various CAD/PLM systems to extract the data required for building virtual tests as well as building and chaining several virtual tests upstream and downstream to achieve an integrated process. It enables the capture, storage and reuse of enterprise knowledge and best practices, as well as the automation of repetitive and cumbersome tasks in a virtual prototyping process, the propagation of engineering changes or design changes from one domain to another.



**JSOL Corporation**

[www.jsol.co.jp/english/cae/](http://www.jsol.co.jp/english/cae/)

## **HYCRASH**

Easy-to-use one step solver, for Stamping-Crash Coupled Analysis. HYCRASH only requires the panels' geometry to calculate manufacturing process effect, geometry of die are not necessary. Additionally, as this is target to usage of crash/strength analysis, even forming analysis data is not needed. If only crash/strength analysis data exists and panel ids is defined. HYCRASH extract panels to calculate it's strain, thickness, and map them to the original data.

## **JSTAMP/NV**

As an integrated press forming simulation system for virtual tool shop

the JSTAMP/NV meets the various industrial needs from the areas of automobile, electronics, iron and steel, etc. The JSTAMP/NV gives satisfaction to engineers, reliability to products, and robustness to tool shop via the advanced technology of the JSOL Corporation.

## **JMAG**

JMAG uses the latest techniques to accurately model complex geometries, material properties, and thermal and structural phenomena associated with electromagnetic fields. With its excellent analysis capabilities, JMAG assists your manufacturing process.



Livermore Software Technology, an ANSYS Company  
[www.lstc.com](http://www.lstc.com)

## LS-DYNA

A general-purpose finite element program capable of simulating complex real world problems. It is used by the automobile, aerospace, construction, military, manufacturing, and bioengineering industries. LS-DYNA is optimized for shared and distributed memory Unix, Linux, and Windows based, platforms, and it is fully QA'd by LST, an ANSYS company. The code's origins lie in highly nonlinear, transient dynamic finite element analysis using explicit time integration.

## LS-PrePost

An advanced pre and post-processor that is delivered free with LS-DYNA. The user interface is designed to be both efficient and intuitive. LS-PrePost runs on Windows, Linux, and Macs utilizing OpenGL graphics to achieve fast rendering and XY plotting.

## LS-OPT

LS-OPT is a standalone Design Optimization and Probabilistic Analysis package with an interface to LS-DYNA. The graphical preprocessor LS-OPTui facilitates definition of the design input and the creation of a command

file while the postprocessor provides output such as approximation accuracy, optimization convergence, tradeoff curves, anthill plots and the relative importance of design variables.

## LS-TaSC

A Topology and Shape Computation tool. Developed for engineering analysts who need to optimize structures, LS-TaSC works with both the implicit and explicit solvers of LS-DYNA. LS-TaSC handles topology optimization of large non-linear problems, involving dynamic loads and contact conditions.

## LST, AN ANSYS COMPANY Dummy Models

Anthropomorphic Test Devices (ATDs), as known as "crash test dummies", are life-size mannequins equipped with sensors that measure forces, moments, displacements, and accelerations.

## LST, AN ANSYS COMPANY Barrier Models

LSTC offers several Offset Deformable Barrier (ODB) and Movable Deformable Barrier (MDB) model.

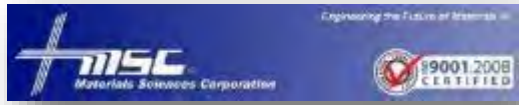

## Material Sciences Corporation

[www.materials-sciences.com](http://www.materials-sciences.com)

Materials Sciences Corporation has provided engineering services to the composites industry since 1970. During this time, we have participated in numerous programs that demonstrate our ability to: perform advanced composite design, analysis and testing; provide overall program management; work in a team environment; and transition new product development to the military and commercial sectors. MSC's corporate mission has expanded beyond basic research and development now to include transitioning its proprietary technologies from the research lab into innovative new products. This commitment is demonstrated through increased staffing and a more than 3-fold expansion of facilities to allow in-house manufacturing and testing of advanced composite materials and structures.

Materials Sciences Corporation (MSC) MAT161/162 - enhanced features have been added to the Dynamic Composite Simulator module of LS-DYNA.

This enhancement to LS-DYNA, known as MAT161/162, enables the most effective and accurate dynamic progressive failure modeling of composite structures to enable the most effective and accurate dynamic progressive

failure modeling of composite structures currently available.

## MSC/LS-DYNA Composite Software and Database -

**Fact Sheet:** <http://www.materials-sciences.com/dyna-factsheet.pdf>

- MSC and LSTC have joined forces in developing this powerful composite dynamic analysis code.
- For the first time, users will have the enhanced ability to simulate explicit dynamic engineering problems for composite structures.
- The integration of this module, known as 'MAT 161', into LS-DYNA allows users to account for progressive damage of various fiber, matrix and interply delamination failure modes.
- Implementing this code will result in the ability to optimize the design of composite structures, with significantly improved survivability under various blast and ballistic threats.

MSC's LS-DYNA module can be used to characterize a variety of composite structures in numerous applications—such as this composite hull under blast.



LS-DYNA ENVIRONMENT

## Oasys Ltd. LS-DYNA Environment

[www.oasys-software.com/dyna](http://www.oasys-software.com/dyna)

The Oasys Suite of software is exclusively written for LS-DYNA® and is used worldwide by many of the largest LS-DYNA® customers. The suite comprises of:

### Oasys PRIMER

Key benefits:

- Pre-Processor created specifically for LS-DYNA®
- Compatible with the latest version of LS-DYNA®
- Maintains the integrity of data
- Over 6000 checks and warnings – many auto-fixable
- Specialist tools for occupant positioning, seatbelt fitting and seat squashing (including setting up pre-simulations)
- Many features for model modification, such as part replace
- Ability to position and depenetrate impactors at multiple locations and produce many input decks automatically (e.g. pedestrian impact, interior head impact)

- Contact penetration checking and fixing
- Connection feature for creation and management of connection entities.
- Support for Volume III keywords and large format/long labels
- Powerful scripting capabilities allowing the user to create custom features and processes

[www.oasys-software.com/dyna](http://www.oasys-software.com/dyna)

### Oasys D3PLOT

Key benefits:

- Powerful 3D visualization post-processor created specifically for LS-DYNA®
- Fast, high quality graphics
- Easy, in-depth access to LS-DYNA® results
- Scripting capabilities allowing the user to speed up post-processing, as well as creating user defined data components





[www.predictiveengineering.com](http://www.predictiveengineering.com)

Predictive Engineering provides finite element analysis consulting services, software, training and support to a broad range of engineering companies across North America. We strive to exceed client expectations for accuracy, timeliness and knowledge transfer. Our process is both cost-effective and collaborative, ensuring all clients are reference clients.

Our mission is to be honest brokers of information in our consulting services and the software we represent.

## **Our History**

Since 1995, Predictive Engineering has continually expanded its client base. Our clients include many large organizations and industry leaders such as SpaceX, Nike, General Electric, Navistar, FLIR Systems, Sierra Nevada Corp, Georgia-Pacific, Intel, Messier-Dowty and more. Over the years, Predictive Engineering has successfully completed more than 800 projects, and has set itself apart on its strong FEA, CFD and LS-DYNA consulting services.



## Shanghai Hengstar

[www.hengstar.com](http://www.hengstar.com)

**Center of Excellence:** Hengstar Technology is the first LS-DYNA training center of excellence in China. As part of its expanding commitment to helping CAE engineers in China, Hengstar Technology will continue to organize high level training courses, seminars, workshops, forums etc., and will also continue to support CAE events such as: China CAE Annual Conference; China Conference of Automotive Safety Technology; International Forum of Automotive Traffic Safety in China; LS-DYNA China users conference etc.

**On Site Training:** Hengstar Technology also provides customer customized training programs on-site at the company facility. Training is tailored for customer needs using LS-DYNA such as material test and input keyword preparing; CAE process automation with customized script program; Simulation result correlation with the test result; Special topics with new LS-DYNA features etc..

**Distribution & Support:** Hengstar distributes and supports LS-DYNA, LS-OPT, LS-Prepost, LS-TaSC, LSTC FEA Models; Hongsheng Lu, previously was directly employed by LSTC before opening his distributorship in China for LSTC software. Hongsheng visits LSTC often to keep update on the latest software features.

Hengstar also distributes and supports d3View; Genesis, Visual DOC, ELSDYNA; Visual-Crash Dyna, Visual-Process, Visual-Environment; EnkiBonnet; and DynaX & MadyX etc.

## Consulting

As a consulting company, Hengstar focuses on LS-DYNA applications such as crash and safety, durability, bird strike, stamping, forging, concrete structures, drop analysis, blast response, penetration etc with using LS-DYNA's advanced methods: FEA, ALE, SPH, EFG, DEM, ICFD, EM, CSEC..

Contact: JSOL Corporation Engineering Technology Division [cae-info@sci.jsol.co.jp](mailto:cae-info@sci.jsol.co.jp)



**Cloud computing services  
for  
JSOL Corporation LS-DYNA users in Japan**

**JSOL Corporation is cooperating with chosen  
cloud computing services**

**JSOL Corporation, a Japanese LS-DYNA distributor for Japanese LS-DYNA customers.**

LS-DYNA customers in industries / academia / consultancies are facing increased needs for additional LS-DYNA cores

In calculations of optimization, robustness, statistical analysis, we find that an increase in cores of LS-DYNA are needed, for short term extra projects or cores.

JSOL Corporation is cooperating with some cloud computing services for JSOL's LS-DYNA users and willing to provide short term license.

This service is offered to customers using Cloud License fee schedule, the additional fee is less expensive than purchasing yearly license.

**The following services are available (only in Japanese). HPC OnLine:**

NEC Solution Innovators, Ltd. - [http://jpn.nec.com/manufacture/machinery/hpc\\_online/](http://jpn.nec.com/manufacture/machinery/hpc_online/)

**Focus** - Foundation for Computational Science  
<http://www.j-focus.or.jp>

**Platform Computation Cloud** - CreDist.Inc.

**PLEXUS CAE**

Information Services International-Dentsu, Ltd. (ISID) <https://portal.plexusplm.com/plexus-cae/>

**SCSK Corporation** - <http://www.scsk.jp/product/keyword/keyword07.html>

# Cloud - HPC Services - Subscription *RESCALE*

[www.rescale.com](http://www.rescale.com)



## Rescale: Cloud Simulation Platform

### The Power of Simulation Innovation

We believe in the power of innovation. Engineering and science designs and ideas are limitless. So why should your hardware and software be limited? You shouldn't have to choose between expanding your simulations or saving time and budget.

Using the power of cloud technology combined with LS-DYNA allows you to:

- Accelerate complex simulations and fully explore the design space
- Optimize the analysis process with hourly software and hardware resources
- Leverage agile IT resources to provide flexibility and scalability

### True On-Demand, Global Infrastructure

Teams are no longer in one location, country, or even continent. However, company data centers are often in one place, and everyone must connect in, regardless of office. For engineers across different regions, this can cause connection issues, wasted time, and product delays.

Rescale has strategic/technology partnerships with infrastructure and software providers to offer the following:

- Largest global hardware footprint – GPUs, Xeon Phi, InfiniBand
- Customizable configurations to meet every simulation demand
- Worldwide resource access provides industry-leading tools to every team
- Pay-per-use business model means you only pay for the resources you use
- True on-demand resources – no more queues

### ScaleX Enterprise: Transform IT, Empower Engineers, Unleash Innovation

The ScaleX Enterprise simulation platform provides scalability and flexibility to companies while offering enterprise IT and management teams the opportunity to expand and empower their organizations.

# Cloud - HPC Services - Subscription **RESCALE**

---

## Rescale Cloud Simulation Platform

[www.rescale.com](http://www.rescale.com)

ScaleX Enterprise allows enterprise companies to stay at the leading edge of computing technology while maximizing product design and accelerating the time to market by providing:

- Collaboration tools
- Administrative control
- API/Scheduler integration
- On-premise HPC integration

### Industry-Leading Security

Rescale has built proprietary, industry-leading security solutions into the platform, meeting the needs of customers in the most demanding and competitive industries and markets.

- Manage engineering teams with user authentication and administrative controls
- Data is secure every step of the way with end-to-end data encryption
- Jobs run on isolated, kernel-encrypted, private clusters
- Data centers include biometric entry authentication
- Platforms routinely submit to independent external security audits

Rescale maintains key relationships to provide LS-DYNA on demand on a global scale. If you have a need to accelerate the simulation process and be an innovative leader, contact Rescale or the following partners to begin running LS-DYNA on Rescale's industry-leading cloud simulation platform.

**LSTC - DYNAmore GmbH JSOL Corporation**

Rescale, Inc. - 1-855-737-2253 (1-855-RESCALE) - [info@rescale.com](mailto:info@rescale.com)

944 Market St. #300, San Francisco, CA 94102 USA



ESI Cloud offers designers and engineers cloud-based computer aided engineering (CAE) solutions across physics and engineering disciplines.

ESI Cloud combines ESI's industry tested virtual engineering solutions integrated onto ESI's Cloud Platform with browser based modeling,

### **With ESI Cloud users can choose from two basic usage models:**

- An end-to-end SaaS model: Where modeling, multi-physics solving, results visualization and collaboration are conducted in the cloud through a web browser.
- A Hybrid model: Where modeling is done on desktop with solve, visualization and collaboration done in the cloud through a web browser.

### **Virtual Performance Solution:**

ESI Cloud offers ESI's flagship Virtual Performance Solution (VPS) for multi-domain performance simulation as a hybrid offering on its cloud platform. With this offering, users can harness the power of Virtual Performance Solution, leading multi-domain CAE solution for virtual engineering of crash, safety, comfort, NVH (noise, vibration and harshness), acoustics, stiffness and durability.

In this hybrid model, users utilize VPS on their desktop for modeling including geometry, meshing and simulation set up. ESI Cloud is then used for high performance computing with an integrated visualization and real time collaboration offering through a web browser.

### **The benefits of VPS hybrid on ESI Cloud include:**

- Running large concurrent simulations on demand
- On demand access to scalable and secured cloud HPC resources
- Three tiered security strategy for your data
- Visualization of large simulation data sets
- Real-time browser based visualization and collaboration
- Time and cost reduction for data transfer between cloud and desktop environments
- Support, consulting and training services with ESI's engineering teams

## VPS On Demand

ESI Cloud features the Virtual Performance Solution (VPS) enabling engineers to analyze and test products, components, parts or material used in different engineering domains including crash and high velocity impact, occupant safety, NVH and interior acoustics, static and dynamic load cases. The solution enables VPS users to overcome hardware limitations and to drastically reduce their simulation time by running on demand very large concurrent simulations that take advantage of the flexible nature of cloud computing.

### Key solution capabilities:

- Access to various physics for multi-domain optimization
- Flexible hybrid model from desktop to cloud computing
- On demand provisioning of hardware resources
- Distributed parallel processing using MPI (Message Passing Interface) protocol
- Distributed parallel computing with 10 Gb/s high speed interconnects

## Result visualization

ESI Cloud deploys both client-side and server-side rendering technologies. This enables the full interactivity needed during the simulation workflow along with the ability to handle large data generated for 3D result visualization in the browser, removing the need for time consuming data transfers. Additionally ESI Cloud visualization engine enables the comparisons of different results through a multiple window user interface design.

### Key result visualization capabilities:

- CPU or GPU based client and server side rendering
- Mobility with desktop like performance through the browser
- 2D/3D VPS contour plots and animations
- Custom multi-window system for 2D plots and 3D contours
- Zooming, panning, rotating, and sectioning of multiple windows

## Collaboration

To enable real time multi-user and multi company collaboration, ESI Cloud offers extensive synchronous and asynchronous collaboration capabilities. Several users can view the same project, interact with the same model results, pass control from one to another. Any markups, discussions or annotations can be archived for future reference or be assigned as tasks to other members of the team.

### Key collaboration capabilities:

- Data, workflow or project asynchronous collaboration
- Multi-user, browser based collaboration for CAD, geometry, mesh and results models
- Real-time design review with notes, annotations and images archiving and retrieval
- Email invite to non ESI Cloud users for real time collaboration

## TOYOTA - Total Human Model for Safety – THUMS



The Total Human Model for Safety, or THUMS®, is a joint development of Toyota Motor Corporation and Toyota Central R&D Labs. Unlike dummy models, which are simplified representation of humans, THUMS represents actual humans in detail, including the outer shape, but also bones, muscles, ligaments, tendons, and internal organs. Therefore, THUMS can be used in automotive crash simulations to identify safety problems and find their solutions.

Each of the different sized models is available as sitting model to represent vehicle occupants



and as standing model to represent pedestrians.



The internal organs were modeled based on high resolution CT-scans.

THUMS is limited to civilian use and may under no circumstances be used in military applications.

**LSTC is the US distributor for THUMS.** Commercial and academic licenses are available.

For information please contact: [THUMS@lstc.com](mailto:THUMS@lstc.com)

THUMS®, is a registered trademark of Toyota Central R&D Labs.



# ATD - Human Models - Barrier

## LST, An ANSYS Company – Dummy Models

### Crash Test Dummies (ATD)

Meeting the need of their LS-DYNA users for an affordable crash test dummy (ATD), LSTC offers the LSTC developed dummies at no cost to LS-DYNA users.

LSTC continues development on the LSTC Dummy models with the help and support of their customers. Some of the models are joint developments with their partners.

e-mail to: [atds@lstc.com](mailto:atds@lstc.com)

Models completed and available  
(in at least an alpha version)

- Hybrid III Rigid-FE Adults
- Hybrid III 50th percentile FAST
- Hybrid III 5th percentile detailed
- Hybrid III 50th percentile detailed
- Hybrid III 50th percentile standing
- EuroSID 2
- EuroSID 2re
- SID-IIs Revision D
- USSID
- Free Motion Headform
- Pedestrian Legform Impactors

Models In Development

- Hybrid III 95th percentile detailed
- Hybrid III 3-year-old
- Hybrid II
- WorldSID 50th percentile
- THOR NT FAST
- Ejection Mitigation Headform

Planned Models

- FAA Hybrid III
- FAST version of THOR NT
- FAST version of EuroSID 2
- FAST version of EuroSID 2re
- Pedestrian Headforms
- Q-Series Child Dummies
- FLEX-PLI



# ATD - Human Models - Barrier

## LST, An ANSYS Company – Barrier Models

Meeting the need of their LS-DYNA users for affordable barrier models, LSTC offers the LSTC developed barrier models at no cost to LS-DYNA users.

LSTC offers several Offset Deformable Barrier (ODB) and Movable Deformable Barrier (MDB) models:

- ODB modeled with shell elements
- ODB modeled with solid elements
- ODB modeled with a combination of shell and solid elements
- MDB according to FMVSS 214 modeled with shell elements
- MDB according to FMVSS 214 modeled with solid elements
- MDB according to ECE R-95 modeled with shell elements
- AE-MDB modeled with shell elements
- IIHS MDB modeled with shell elements
- IIHS MDB modeled with solid elements
- RCAR bumper barrier
- RMDB modeled with shell and solid elements

LSTC ODB and MDB models are developed to correlate to several tests provided by our customers. These tests are proprietary data and are not currently available to the public.

All current models can be obtained through our webpage in the LSTC Models download section or through your LS-DYNA distributor.

To submit questions, suggestions, or feedback about LSTC's models, please send an e-mail to: [atds@lstc.com](mailto:atds@lstc.com). Also, please contact us if you would like to help improve these models by sharing test data.



# Social Media

---



## FACEBOOK

[BETA CAE Systems](#)  
[ESI Group](#)

[CADFEM](#)



## TWITTER

[BETA CAE Systems](#)  
[ETA](#)

[CADFEM](#)

[ESI Group](#)



## LINKEDIN

[BETA CAE Systems](#)  
[DYNAmore Nordic](#)  
[ESI Group](#)

[CADFEM](#)

[ETA](#)



## YOUTUBE

### YOUTUBE Channel

[BETA CAE Systems](#)  
[CADFEM](#)  
[ESI Group](#)  
[ETA](#)  
[Lancemore](#)  
[LS-DYNA OnLine - \(Al Tabiei\)](#)

### WebSite URL

[www.beta-cae.com](http://www.beta-cae.com)  
[www.cadfem.de](http://www.cadfem.de)  
[www.esi-group.com](http://www.esi-group.com)  
[www.eta.com](http://www.eta.com)  
[www.lancemore.jp/index\\_en.html](http://www.lancemore.jp/index_en.html)  
<https://www.youtube.com/user/LSDYNATV>

## GOOGLE+

[BETA CAE Systems](#)